

Product Note 11729C-2

Phase Noise Characterization of Microwave Oscillators

Frequency Discriminator Method

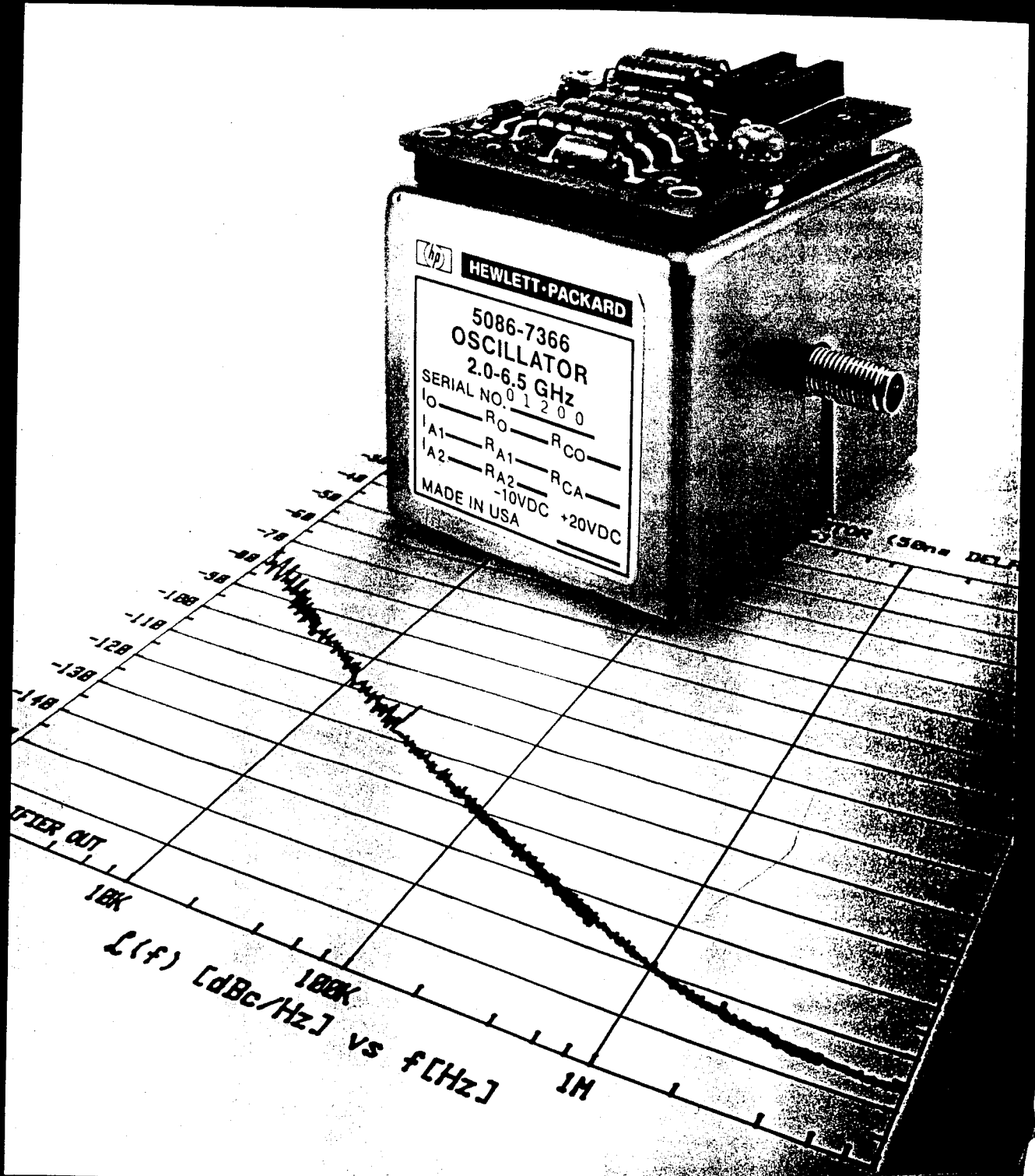

Phase Noise Characterization of Microwave Oscillators Frequency Discriminator Method

	Page
Table of Contents	
Chapter 1: Introduction	3
Chapter 2: Phase Noise and its Effect on Microwave Systems	4
What is Phase Noise	4
Two-port and Absolute Noise	7
Why Phase Noise is Important	7
Digital Communications Systems	8
Analog Microwave Communications Systems	8
Doppler Radar System	8
Chapter 3: Phase Noise Measurements — Frequency Discriminator Method	10
Common Measurement Techniques	10
Direct Measurement	10
Heterodyne/Counter Measurement	10
Carrier Removal/Demodulation	10
Measurement with a Phase Detector	11
Measurement with a Frequency Discriminator	12
The Delay Line/Mixer Frequency Discriminator Method	12
Basic Theory	12
The Discriminator Transfer Response	12
System Sensitivity	13
Optimum Sensitivity	14
Making A Measurement	15
System Setup	15
System Calibration	15
The Phase Noise Measurement	16
Chapter 4: HP 11729C Carrier Noise Test Set Theory of Operation and Measurement Considerations	18
General Operation	18
Multiplier Chain	18
Demodulating and Bandpass Signal Processing	20
First Down Conversion	20
IF Processing and the Frequency Discriminator	20
Baseband Signal Processing	20
Phase Locked Loop/Quadrature Section	21
Chapter 5: Making Frequency (Phase) Noise Measurements with the HP 11729C	22
System Setup	22
The Source	22
The 640 MHz Drive Signal	22
The Delay Line	23
System Operation	24
System Calibration	24
The Calibration Signal	24
System Response	25
The Discriminator Constant (K_d)	26
Measuring the Frequency (Phase) Noise	26
Measurement Corrections	27
Conversion to Other Units	27

Table of Contents (cont'd)	Page
Chapter 6: Considerations in System Accuracy	29
Spectrum Analyzer	29
Relative Amplitude Accuracy	29
Resolution Bandwidth Accuracy	29
The IF Gain Accuracy	29
Spectrum Analyzer Frequency Response	29
System Parameters of the HP 11729C	30
Frequency Discriminator Flatness	30
Baseband Signal Processing Section Flatness	30
System Noise Floor	30
Measurement Procedure	31
Quadrature Maintenance	31
System Calibration	31
The Randomness of Noise	31
Overall Accuracy	31
Accuracy Without Error Correction	32
Accuracy With Error Correction	32
 Appendix A: The Delay Line/Mixer Frequency	
Discriminator Transfer Response	34
Appendix B: The Double-Balanced Mixer as a Phase Detector	36
Appendix C: System Sensitivity	38
Appendix D: Calibration and the Discriminator Constant K_d	40
Appendix E: The Importance of Quadrature	41
Appendix F: HP 11729C Programming Codes	42
Appendix G: References	43

1 Introduction

As the performance of microwave radar and communication systems advances, certain system parameters take on increased importance. One of these parameters that must be measured is the spectral purity of microwave signal sources.

In the past, many techniques for measuring spectral purity have used complex, dedicated instrumentation, often cumbersome in both size and operation and often limited to narrow bands of operating frequency. The broadening focus on spectral purity has created a need for measurement techniques that provide the high performance necessary for R&D requirements, and that can be automated for production environments. Also, service applications require a versatile system with a broad frequency and performance range.

The Hewlett-Packard 11729C Carrier Noise Test Set is a key element of a system that provides convenient manual or automatic phase noise measurements. With appropriate companion instrumentation, phase noise measurements can be made on a broad range of sources, from 10 MHz to 18 GHz.

This product note discusses phase noise and its effects on modern microwave systems in Chapter 2. Chapter 3 describes a frequency discriminator technique for measuring the phase noise of sources. The implementation of this technique with the HP 11729C is shown in Chapter 4. (See HP product note PN 11729B-1 for phase detector method.) Chapter 5 outlines the measurement steps needed to make a phase noise measurement, and the resultant measurement accuracy is derived in Chapter 6.

2 Phase Noise and its Effect on Microwave Systems

WHAT IS PHASE NOISE?

Frequency stability can be defined as the degree to which an oscillating source produces the same frequency throughout a specified period of time. Every RF and microwave source exhibits some amount of frequency instability. This stability can be broken down into two components—long-term and short-term stability.

Long-term stability describes the frequency variations that occur over long time periods, expressed in parts per million per hour, day, month, or year. Short-term frequency stability contains all elements causing frequency changes about the nominal frequency of less than a few seconds duration. This product note deals with short-term frequency stability.

Mathematically, an ideal sinewave can be described by

$$V(t) = V_o \sin(2\pi f_o t)$$

where V_o = nominal amplitude,

$2\pi f_o t$ = linearly growing phase component,

and f_o = nominal frequency.

But an actual signal is better modeled by

$$V(t) = [V_o + \epsilon(t)] \sin [2\pi f_o t + \Delta\phi(t)]$$

where $\epsilon(t)$ = amplitude fluctuations,

and $\Delta\phi(t)$ = randomly fluctuating phase term or phase noise.

This randomly fluctuating phase term $\Delta\phi(t)$ could be observed on an ideal spectrum analyzer (one which had no sideband noise of its own) as in Figure 2.1a. There are two types of fluctuating phase terms. The first, deterministic, are discrete signals appearing as distinct components in the spectral density plot. These signals, commonly called spurious, can be related to known phenomena in the signal source such as power line frequency, vibration frequencies, or mixer products.

The second type of phase instability is random in nature, and is commonly called phase noise. The sources of random sideband noise in an oscillator include thermal noise, shot noise, and flicker noise.

Many terms exist to quantify the characteristic randomness of phase noise. Essentially, all methods measure the frequency or phase deviations of the source under test in either the frequency or time domain. Since frequency and phase are related to each other, all of the terms that characterize phase noise are also related.

One fundamental description of phase instability or phase noise is the spectral density of phase fluctuations on a per-Hertz basis. The term spectral density describes the energy distribution as a continuous function, expressed in units of phase variance per unit bandwidth. Thus $S_\phi(f_m)$ (Figure 2.1b) may be considered as

$$S_\phi(f_m) = \frac{\Delta\phi_{rms}^2(f_m)}{\text{BW used to measure } \Delta\phi_{rms}} \quad \frac{\text{rad}^2}{\text{Hz}}$$

where BW (bandwidth) is negligible with respect to any changes in S_ϕ versus the Fourier frequency or offset frequency f_m .

Figure 2.1. CW Signal sidebands viewed in the frequency domain.

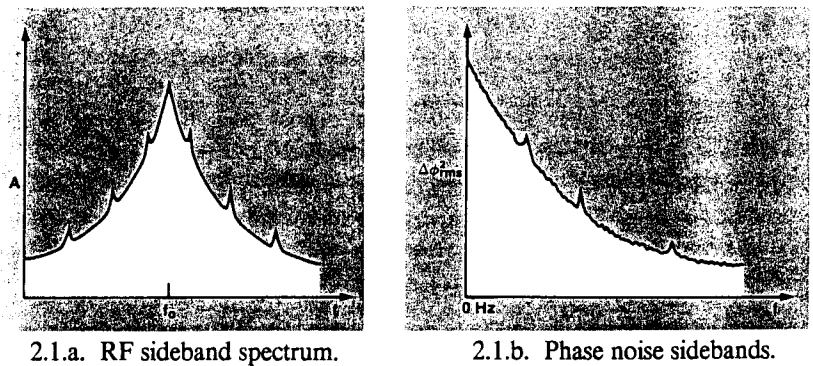

Another useful measure of the noise energy is $\mathcal{L}(f_m)$, which is then directly related to $S_\phi(f_m)$ by a simple approximation which has generally negligible error if the modulation sidebands are such that the total phase deviations are much much less than 1 radian ($\Delta\phi_{pk} \ll 1$ radian).

$$\mathcal{L}(f_m) \approx \frac{1}{2} S_\phi(f_m).$$

$\mathcal{L}(f_m)$ is an indirect measure of noise energy easily related to the RF power spectrum observed on a spectrum analyzer. Figure 2.2 shows that the U.S. National Bureau of Standards defines $\mathcal{L}(f_m)$ as the ratio of the power in one phase modulation sideband to the total signal power (at an offset f_m Hertz away from the carrier). The phase modulation sideband is based on a per Hertz of bandwidth spectral density and f_m equals the Fourier frequency or offset frequency.

$$\mathcal{L}(f_m) = \frac{\text{power density (in one phase modulation sideband)}}{\text{total signal power}} = \frac{P_{ssb}}{P_s}$$

= single sideband (SSB) phase noise to carrier ratio per Hz.

$\mathcal{L}(f_m)$ is usually presented logarithmically as a spectral density of the phase modulation sidebands in the plot of the phase frequency domain, expressed in dB relative to the carrier per Hz (dBc/Hz), as shown in Figure 2.3

Figure 2.2. Deriving $\mathcal{L}(f_m)$ from a spectrum analyzer display.

Figure 2.3. $\mathcal{L}(f_m)$ described logarithmically as a function of offset frequency.

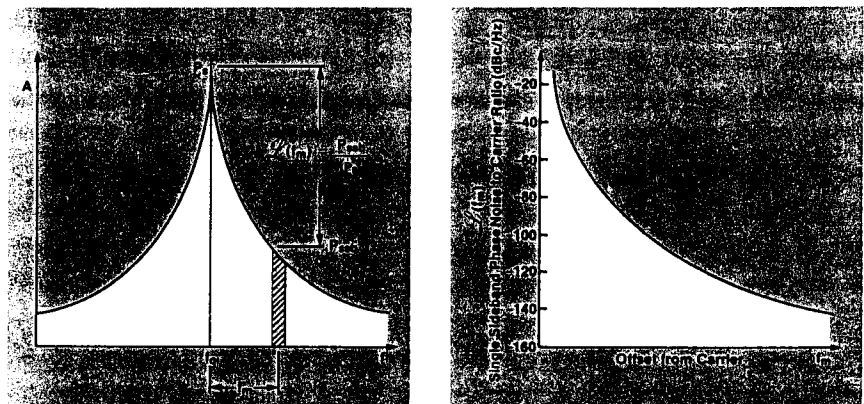

Caution must be exercised when $\mathcal{L}(f_m)$ is calculated from the spectral density of the phase fluctuations $S_\phi(f_m)$ because the calculation of $\mathcal{L}(f_m)$ is dependent on the small angle criterion. Figure 2.4, the measured phase noise of a free running VCO described

in units of $\mathcal{L}(f_m)$, illustrates the erroneous results that can occur if the instantaneous phase modulation exceeds a small angle. Approaching the carrier, $\mathcal{L}(f_m)$ obviously increases in error as it indicates a relative level of +45 dBc/Hz at a 1 Hz offset (45 dB more noise power at a 1 Hz offset in a 1 Hz bandwidth than in the total power of the signal); which is of course invalid.

Figure 2.4 shows a 10 dB/decade line drawn over the plot, indicating a peak phase deviation of 0.2 radians integrated over any one decade of offset frequency. At approximately 0.2 radians the power in the higher order sidebands of the phase modulation is still insignificant compared to the power in the first order sideband which insures that the calculation of $\mathcal{L}(f_m)$ remains valid. Above the line the plot of $\mathcal{L}(f_m)$ becomes increasingly invalid, and $S_\phi(f_m)$ must be used to represent the phase noise of the signal.

Figure 2.4. Region of validity of

$$\mathcal{L}(f_m) = \frac{S_\phi(f_m)}{2}$$

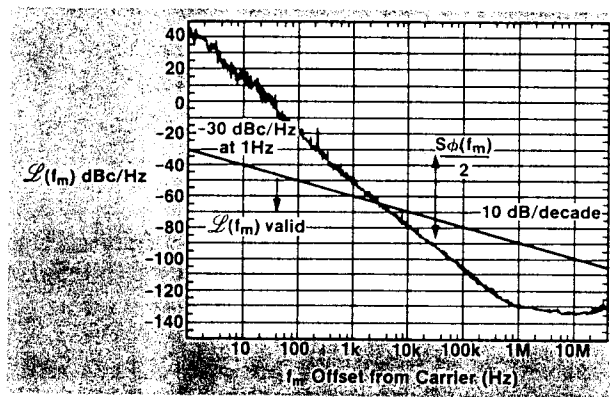

Another common term for quantifying short term frequency instability (phase noise) is $S_{\Delta f}(f_m)$, the spectral density of frequency fluctuations. Again the term spectral density describes the energy distribution as a continuous function, expressed in units of frequency variance per unit bandwidth. Thus, $S_{\Delta f}(f_m)$ can be considered as

$$S_{\Delta f}(f_m) = \frac{\Delta f_{rms}^2(f_m)}{\text{BW used to measure } \Delta f_{rms}} \quad \frac{\text{Hz}^2}{\text{Hz}}$$

where BW is negligible with respect to any changes in S_ϕ versus f_m .

Because frequency is the time rate of change of phase, the three common terms $S_\phi(f_m)$, $\mathcal{L}(f_m)$, and $S_{\Delta f}(f_m)$ can be related as shown.

$$S_\phi(f_m) = \frac{S_{\Delta f}(f_m)}{f_m^2} \quad \mathcal{L}(f_m) = \frac{S_{\Delta f}(f_m)}{2f_m^2} \quad (\text{for region of validity})$$

As shown in Chapter 3, a frequency discriminator outputs a voltage directly proportional to $S_{\Delta f}(f_m)$. However, since phase noise is typically specified as $\mathcal{L}(f_m)$ or $S_\phi(f_m)$, the graphical relationship to these other units is shown in Figure 2.5.

$S_v(f_m)$ is the power spectral density of the voltage fluctuations out of the detection system. For small BW, $S_v(f_m)$ may be considered as

Figure 2.5. The phase noise of a synthesized 10 GHz source plotted in terms of phase fluctuations, frequency fluctuations, and $\mathcal{L}(f_m)$.

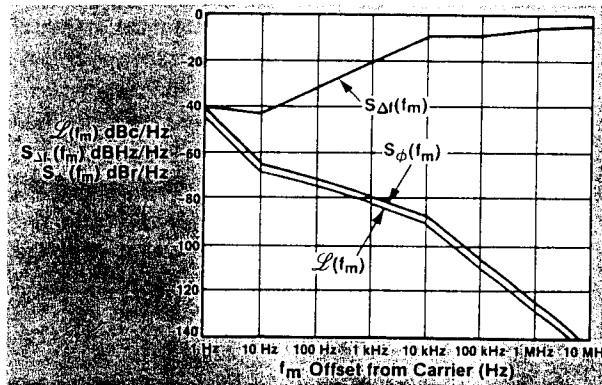

$$S_v(f_m) = \frac{\Delta V_{rms}^2(f_m)}{\text{BW used to measure } \Delta V_{rms}} \quad \frac{V^2}{\text{Hz}}$$

Because of the large magnitude variations of the phase noise on an oscillator, it is convenient to talk about phase noise in logarithmic terms.

$$S_{\Delta f}(f_m) \text{ expressed logarithmically is } S_{\Delta f}(f_m) [\text{dBHz/Hz}] = 20 \log \frac{\Delta f(\text{Hz})}{1 (\text{Hz})} \text{ per Hz}$$

$$S_{\phi}(f_m) \text{ expressed logarithmically is } S_{\phi}(f_m) [\text{dB/Hz}] = 20 \log \frac{\Delta \phi(\text{rad})}{1 (\text{rad})} \text{ per Hz}$$

$$\mathcal{L}(f_m) \text{ expressed logarithmically is } \mathcal{L}(f_m) [\text{dBc/Hz}] = 10 \log \frac{P_{\text{noise}}}{P_{\text{carrier}}} \text{ per Hz}$$

The relations between $S_{\Delta f}(f_m)$, $S_{\phi}(f_m)$, and $\mathcal{L}(f_m)$ become

$$S_{\phi}(f_m) [\text{dB/Hz}] = S_{\Delta f}(f_m) [\text{dBHz/Hz}] - 20 \log \frac{f_m}{1 (\text{Hz})}$$

and

$$\mathcal{L}(f_m) [\text{dBc/Hz}] = S_{\Delta f}(f_m) [\text{dBHz/Hz}] - 20 \log \frac{f_m}{1 (\text{Hz})} - 3 \text{ dB}$$

where dBHz/Hz is dB relative to one Hz per Hz bandwidth, dB/Hz is dB relative to one radian per Hz bandwidth, and dBc/Hz is dB relative to a carrier per Hz bandwidth.

TWO PORT AND ABSOLUTE NOISE

There are two different types of phase noise commonly specified. They are two-port phase noise and absolute phase noise. Two-port phase noise refers to the noise of devices. Amplifiers, mixers, and multipliers have two-port phase noise. Two-port noise results from the noise contributed by a device, regardless of the noise of the driving source. Absolute phase noise refers to the total phase noise present at the output of a source or system. It is a function of both the device two-port phase noise and the oscillator noise.

The procedures described in this note are for making absolute phase noise measurements on microwave sources. In general, the absolute phase noise of a source is most important in the final system application. However, two-port noise of devices or synthesized sources might also be measured prior to system integration. For two-port measurements of devices, the HP 3047A Phase Noise Measurement System is a good solution. HP application note AN 57-1 provides a comprehensive review of fundamentals of noise characteristics of two-port networks.

WHY PHASE NOISE IS IMPORTANT

Phase noise on signal sources is a concern in frequency conversion applications where signal levels span a wide dynamic range. The frequency offset of concern and the tolerable level of noise at this offset vary greatly for different microwave systems. Sideband phase noise can convert into the information passband and limit the overall system sensitivity.

This general case is illustrated in Figure 2.6. Suppose two desired signals f_1 and f_2 are input to the frequency conversion system, where they are to be mixed with a local oscillator signal f_{LO} (Figure 2.6a) down to an intermediate frequency (IF) for processing. The phase noise of the local oscillator will be directly translated onto the mixer products (Figure 2.6b). Note that though the system's IF filtering may be sufficient to resolve the larger signal's mixing product ($f_1 - f_{LO}$), the smaller signal's mixing product ($f_2 - f_{LO}$) is no longer recoverable due to the translated local oscillator noise. The noise on the local oscillator thus degrades the system's sensitivity as well as its selectivity. Three specific examples of frequency conversion applications where phase noise is important follow.

Figure 2.6. Effect of LO noise in frequency conversion application.

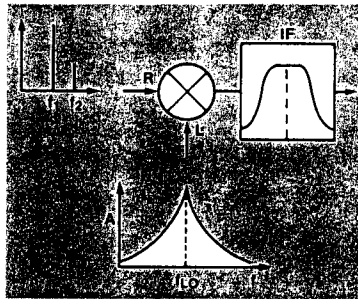

2.6.a. Inputs to mixer.

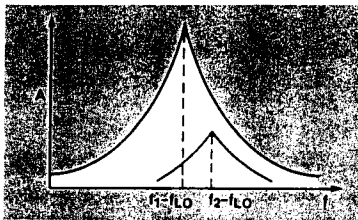

2.6.b. IF output.

Digital Communications System

In digital communications, phase noise very close to the carrier (less than 1 kHz) is important. Close-in phase noise (or phase jitter in the time domain) on the system local oscillator (LO) affects the system bit-error rate.

Analog Microwave Communications System

In many analog communications systems, modulation information exists at least several hundred kHz away from the carrier. Initially, the signal-to-noise ratio is sufficiently high. However, in each repeater station, the incoming signal is amplified, usually with a down & up conversion method, increasing the level of broadband noise on the carrier. If the signal passes through several repeater stations, the level of this broadband noise induced by the L.O. can increase and start to mask the information. Too high a level of broadband noise on each system local oscillator will affect the signal-to-noise (or system sensitivity) at the receiving end of a multiple repeater system.

Doppler Radar System

Doppler radars determine the velocity of a target by measuring the small shifts in frequency that the return echoes have undergone. In actual systems, however, the return signal is much more than just the target echo. The return includes a large 'clutter' signal from the large, stationary earth (Figure 2.7). If this clutter return is decorrelated by the delay time difference, the phase noise from the local oscillator can partially or even totally mask the target signal. Thus, phase noise on the local oscillator can set the minimum signal level that must be returned by a target in order to be detectable.

Figure 2.7. Effect of carrier phase noise in a Doppler radar system.

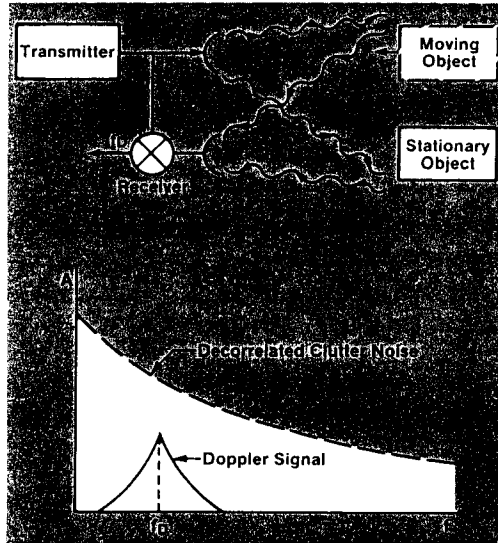

3 Phase Noise Measurements—Frequency Discriminator Method

COMMON MEASUREMENT TECHNIQUES

There are several methods of making phase noise measurements, each with its own set of advantages and disadvantages. This brief summary of some of the most common methods also adds a few comments about their applicability.

Direct Spectrum Measurement

The most straightforward method of phase noise measurement inputs the test signal into a spectrum analyzer, directly measuring the power spectral density of the oscillator. However, this method may be significantly limited by the spectrum analyzer's dynamic range, resolution, and its own LO phase noise.

Though this direct measurement is not useful for measurements close-in to a drifting carrier, it provides a convenient method for qualitative, quick evaluation on sources with relatively high noise. The following conditions make the measurement valid:

- A. the spectrum analyzer SSB phase noise at the offset of interest must be lower than the noise of the Device Under Test (DUT);
- B. since the spectrum analyzer will measure total noise power, the amplitude noise of the DUT must be significantly below its own phase noise. (Typically 10 dB will suffice.)

Heterodyne/Counter Measurement

This time domain method down-converts the signal under test to an intermediate frequency. The down-converting signal must be of greater stability than the signal to be measured. Then a high resolution frequency counter repeatedly counts the IF signal frequency, with the time period between each measurement held constant. This allows several calculations of the fractional frequency difference, y , over the time period used. From these values for y , the Allan variance, $\sigma_y(\tau)$ can be computer. $\sigma_y(\tau)$ in the time domain corresponds to $S_y(f_m)$ in the frequency domain.

This method gives particularly useful results for short-term frequency instabilities occurring over periods of time greater than 10 ms (less than 100 Hz offset from the carrier in the frequency domain), where the phase noise is increasing rapidly. Using the heterodyne/counter method is ideal for close-in measurements on frequency standards. However, it is not well suited for measurements of noise at offsets from the carrier greater than 10 kHz (Figure 3.1), or for measuring noise which is flat or decreasing slowly vs. offset frequency f_m (as a function having a frequency domain slope of $1/f_m$ or less).

Figure 3.1. Heterodyne frequency measurement.

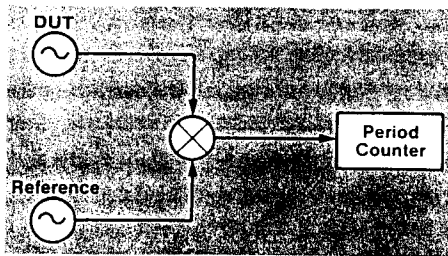

Carrier Removal/Demodulation

Most of the techniques for phase noise measurements fall into this class. Increased sensitivity results by nulling the carrier, or demodulating the carrier and then measuring the noise on the resultant baseband signal. Most common of this class are 1) measurements with a phase detector and 2) measurements with a frequency discriminator. Figure 3.2 compares some typical sensitivities of these methods and the heterodyne/counter measurement.

Figure 3.2. Comparison of typical system sensitivities at 10 GHz.

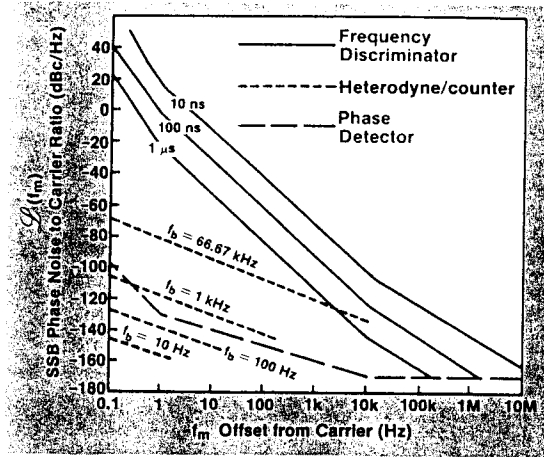

Measurement with a Phase Detector

The basic phase detector or two-source method (Figure 3.3) uses a double-balanced mixer to convert phase fluctuations into baseband voltage fluctuations. Two signals at the same frequency (f_0) are input into the mixer. The sum frequency ($2f_0$) is filtered off with a low-pass filter (LPF) leaving the difference frequency. If the two signals are 90° out of phase (phase quadrature) the difference frequency will be 0 Hz with an average output voltage of 0V. Riding on this dc signal are ac voltage fluctuations that are linearly proportional to the phase noise of both sources.

Figure 3.3. Basic phase detector method.

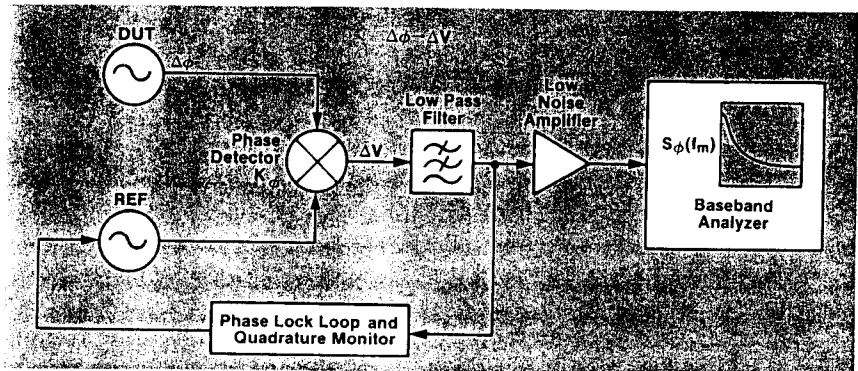

As mentioned above, for the mixer to act as a phase detector, the two signals need to be 90° out of phase. Usually this quadrature condition is maintained by phase locking the two signals. Phase locking requires that at least one of the sources be electronically tunable and requires some type of circuitry to drive the tunable source. The quadrature condition is indicated by zero volts dc at the output of the phase detector and can be monitored with an oscilloscope or a dc volt meter.

Figure 3.2 indicates that the phase detector method yields the best overall sensitivity. However, because the two signals must be phase locked, the phase detector method works optimally with fairly stable sources. The reference source must have lower phase noise than the DUT, and measurements made inside the loop bandwidth (bandwidth used to phase lock the two sources) require correction, increasing the complexity of the phase detector method. See HP product note PN 11729B-1 for a complete discussion of the phase detector method.

Measurement with a Frequency Discriminator

Unlike the phase detector method, the frequency discriminator method does not require a second reference source phase locked to the source under test (Figure 3.4). This makes the frequency discriminator method extremely useful for measuring sources that are difficult to phase lock, including sources that are microphonic or drifting quickly. It can also be used to measure sources with high-level, low-rate phase noise, or high close-in spurious sidebands, conditions which can pose serious problems for the phase detector method. Frequency discriminators can be implemented in several common ways including cavity resonators, RF bridges, and a delay line/mixer. A wide band delay line/mixer frequency discriminator is easy to implement using the HP 11729C Carrier Noise Test Set and common coaxial cable. This wide-band approach will be discussed in detail in this and subsequent chapters.

THE DELAY LINE/MIXER FREQUENCY DISCRIMINATOR METHOD

Basic Theory

The delay line/mixer implementation of a frequency discriminator (Figure 3.4) converts the short-term frequency fluctuations of a source into voltage fluctuations that can be measured by a baseband spectrum analyzer. The conversion is a two part process, first converting the frequency fluctuations into phase fluctuations, and then converting the phase fluctuations to voltage fluctuations.

The frequency fluctuation to phase fluctuation transformation ($\Delta f \rightarrow \Delta \phi$) takes place in the delay line. The nominal frequency arrives at the double-balanced mixer at a particular phase. As the frequency changes slightly, the phase shift incurred in the fixed delay time will change proportionally. The delay line converts the frequency change at the line input to a phase change at the line output when compared to the undelayed signal arriving at the mixer in the second path.

The double-balanced mixer, acting as a phase detector, transforms the instantaneous phase fluctuations into voltage fluctuations ($\Delta \phi \rightarrow \Delta V$). With the two input signals 90° out of phase (phase quadrature), the voltage out is proportional to the input phase fluctuations. The voltage fluctuations can then be measured by a baseband spectrum analyzer and converted to phase noise units.

Figure 3.4. Basic delay line/mixer frequency discriminator method.

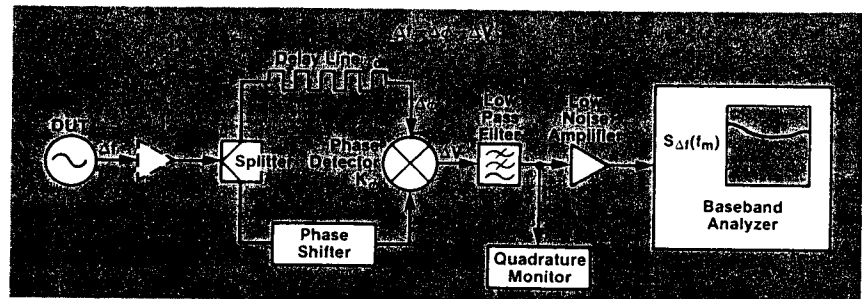

The Discriminator Transfer Response

Appendix A develops the complete transformation from frequency fluctuations (phase noise) to voltage fluctuations by the delay line/mixer frequency discriminator. The important equation is the final magnitude of the transfer response.

$$\Delta V(f_m) = K_\phi 2\pi\tau_d \Delta f(f_m) \frac{\sin(\pi f_m \tau_d)}{(\pi f_m \tau_d)}$$

Where $\Delta V(f_m)$ represents the voltage fluctuations out of the discriminator and $\Delta f(f_m)$ represents the frequency fluctuations of the device under test (DUT). K_ϕ is the phase

detector constant (phase to voltage translation) as developed in Appendix B. τ_d is the amount of delay provided by the delay line and f_m is the frequency offset from the carrier that the phase noise measurement is made.

System Sensitivity

A frequency discriminator's system sensitivity is determined by the transfer response. As shown below, it is desirable to make both the phase detector constant K_ϕ and the amount of delay τ_d large so that the voltage fluctuations ΔV out of a frequency discriminator will be measurable for even small frequency fluctuations Δf .

$$\Delta V(f_m) = \left[K_\phi 2\pi\tau_d \frac{\sin(\pi f_m \tau_d)}{(\pi f_m \tau_d)} \right] \Delta f(f_m)$$

NOTE: The system sensitivity is independent of carrier frequency f_c .

The magnitude of the sinusoidal output term of the frequency discriminator is proportional to $\sin(\pi f_m \tau_d)/(\pi f_m \tau_d)$. This implies that the output response will have peaks and nulls, with the first null occurring at $f_m = 1/\tau_d$. Increasing the rate of a modulation signal applied to the system will cause nulls to appear at frequency multiples of $1/\tau_d$ (Figure 3.5).

Figure 3.5. Nulls in sensitivity of delay line discriminator.

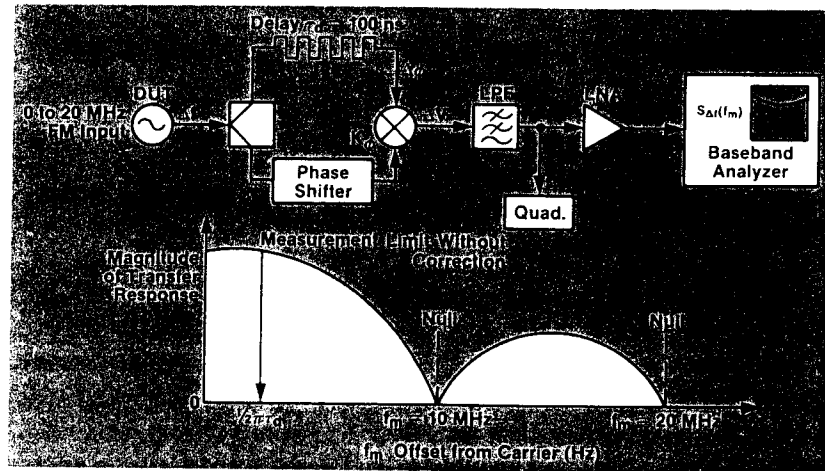

To avoid having to compensate for the $\sin(x)/x$ response, measurements are typically made at offset frequencies (f_m) much less than $1/\tau_d$. It is possible to measure at offset frequencies out to and beyond the null by scaling the measured results using the transfer equation. However, the sensitivity of the system gets very poor near the nulls.

The transfer function shows that increasing τ_d increases the sensitivity of the system. However, increasing τ_d also decreases the offset frequencies (f_m) that can be measured without compensating for the $\sin(x)/x$ response. For example a 200 ns delay line will have better sensitivity close to the carrier than a 50 ns line, but will not be usable beyond 2.5 MHz offsets without compensating for the $\sin(x)/x$ response; the 50 ns line is usable to offsets of 10 MHz.

Increasing the delay, τ_d , also increases the attenuation of the line. While this has no direct effect on the sensitivity provided by the delay line, it does reduce the signal into the phase detector and can result in decreased K_ϕ and decreased system sensitivity.

As developed in Appendix B the phase detector constant K_ϕ equals the slope of the mixer sine wave output at the zero crossings. When the mixer is not in compression, K_ϕ equals $K_L V_R$ where K_L is the mixer efficiency and V_R is the voltage into the R port of the mixer. V_R is also the voltage available at the output of the delay line.

Optimum Sensitivity

If measurements are made such that the offset frequency of interest (f_m) is $< 1/2\pi\tau_d$, the $\sin(x)/x$ term can be ignored and the transfer response can be reduced to

$$\Delta V(f_m) = K_d \Delta f(f_m) = K_\phi \pi \tau_d \Delta f(f_m)$$

where K_d is the discriminator constant.

The reduced transfer equation implies that a frequency discriminator's system sensitivity can be increased simply by increasing the delay τ_d , or by increasing the phase detector constant K_ϕ . This assumption is not completely correct. K_ϕ is dependent on the signal level provided by the delay line and cannot exceed a device dependent maximum. This maximum is achieved when the phase detector is operating in compression. Increasing the delay τ_d will reduce the signal level out of the coaxial delay line often reducing the sensitivity of the phase detector. Optimum system sensitivity is obtained in a trade-off between delay and attenuation.

Appendix C develops this trade off in terms of coaxial delay line length L

$$\text{Sensitivity} = K_L V_{in} L X (10)^{-LZ/20}$$

where K_L is the phase detector efficiency, V_{in} is the signal voltage into the delay line, LX (dB) is the sensitivity provided by the delay line and LZ is the attenuation of the delay line. Taking the derivative with respect to length L to find the maximum of this equation results in

$$LZ = 8.7 \text{ dB of attenuation.}$$

The optimum sensitivity for a system with the phase detector operating out of results from using a length of coaxial line that has 8.7 dB of attenuation.

One way to increase the sensitivity of the discriminator when the phase detector is out of compression is to increase the signal into the delay line. This can be accomplished with an RF amplifier before the signal splitter. The noise of the RF amplifier will not degrade the measurement if the two-port noise of the amplifier is much less than the noise of the DUT. However, some attenuation may be needed in the signal path to the local oscillator port of the double-balanced mixer (phase detector) to protect it from excessive power levels.

If the amplified signal puts the phase detector into compression, K_ϕ is at its maximum and system sensitivity is now only dependent on the length of delay τ_d . For maximum sensitivity more delay can be added until the signal level out of the delay line is 8.7 dB below the phase detector compression point.

The following example illustrates how to choose a delay line that provides optimum sensitivity given certain system parameters.

Parameters

Source signal level	+7 dBm
Mixer compression point	+3 dBm
Delay line attenuation at source carrier frequency	30 dB per 100 ns of delay
Highest offset frequency of interest	5 MHz

- 1) To avoid having to correct for the $\sin(x)/x$ response choose the delay such that $\tau_d < \frac{1}{2\pi \cdot 5 \cdot 10^6}$. A delay τ_d of 32 ns or less can be used for offset frequencies out to 5 MHz.
- 2) The attenuation for 32 ns of delay is 30 dB · 32 ns / 100 ns or 9.6 dB. The total signal attenuation through the splitter and the delay line is 15.6 dB. The signal level out of the delay line is -8.6 dBm which is 11.6 dB below the phase detector compression point. Improved sensitivity can be achieved by reducing the length of the delay or by using a more efficient line so that the signal level out is -5.7 dBm or 8.7 dB below the mixer compression point.

Careful delay line selection is crucial for good system sensitivity. In cases where the phase detector is operating out of compression, sensitivity can be increased by using a lower loss delay line, or by amplifying the signal from the DUT. Because attenuation in coaxial lines is frequency dependent, optimum system sensitivity will be achieved with different lengths of line for different carrier frequencies.

Making a Measurement

Making a phase noise measurement with the delay line/mixer implementation of a frequency discriminator can be broken into 3 simple steps: 1) system setup; 2) system calibration; and 3) noise measurement.

System Setup

Figure 3.6 shows a delay line/mixer frequency discriminator implementation. Details to check during the setup are the signal level out of the delay line and the ability to obtain quadrature. If the level is more than 8.7 dB below the phase detector compression point delay line attenuation is too great and maximum sensitivity is not being achieved.

Figure 3.6. Delay line/mixer frequency discriminator.

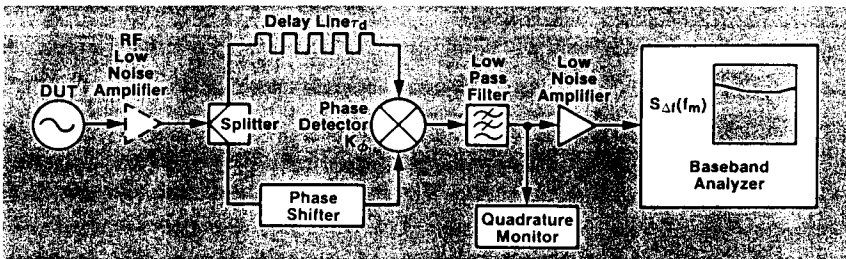

System Calibration

The calibration procedure determines the discriminator constant K_d to use in the transfer response $\Delta V = K_d \Delta f = K_\phi 2\pi\tau_d \Delta f$. K_d can be determined by 1) measuring K_ϕ and τ_d individually, and 2) measuring the overall K_d by measuring the response of the system to a known input.

The delay τ_d is a function of both the length and type of delay line used. For example, for coaxial cables with a polyethelene dielectric the delay is approximately 1.5

ns/foot. An accurate measure of the delay can be made by setting up a delay line discriminator and varying the input signal carrier frequency through two zero crossings on the quadrature monitor (an oscilloscope or dc volt meter). The delay τ_d will equal $1/(2\Delta f_o)$ where Δf_o is the change in the carrier frequency needed to pass through the two consecutive quadrature points.

K_ϕ the phase detector constant can be determined by developing a beat note out of the phase detector as indicated in Appendix B. This method requires a second source to generate the beat note. The signal level of the second source must match the signal level out of the delay line for accurate calibration.

Usually the easiest way to determine the discriminator constant K_d is by measuring the system response to a known FM signal. The signal depicted in Figure 3.7 represents a carrier with a single FM tone. If the modulation index β is kept below 0.2 rad, the power in the higher order sidebands is negligible. Note the system must be operating in quadrature during calibration. K_d [dB] is calculated from the following equation as developed in Appendix D.

$$K_d \text{ [dB]} = P_{\text{cal}} \text{ [dB]} - (\Delta\text{SB}_{\text{cal}} \text{ [dBc/Hz]} + 20 \log f_{\text{m_cal}} \text{ [dBHz]} + 3 \text{ [dB]})$$

P_{cal} is the system response to the known FM signal and is measured with the spectrum analyzer. $\Delta\text{SB}_{\text{cal}}$ is the first sideband to carrier ratio of the calibration signal and $f_{\text{m_cal}}$ is the rate of the FM signal.

Figure 3.7. Carrier with single FM tone.

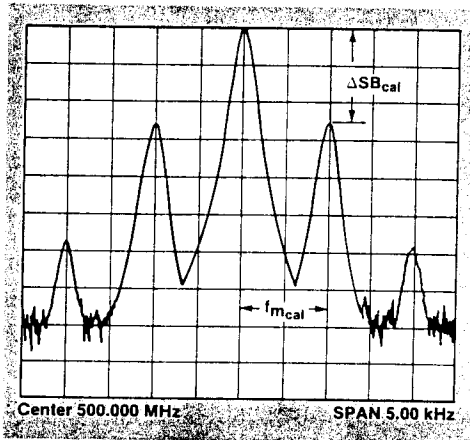

The Phase Noise Measurement

Once K_d [dB] is determined it can be used to convert the detected output of the discriminator $S_v(f_m)$ [dB] into the spectral density of frequency fluctuations of the source $S_{\Delta f}(f_m)$ [dBHz/Hz] (source phase noise). By definition $S_{\Delta f}(f_m) = \Delta f_{\text{rms}}^2(f_m)$ in a 1 Hz bandwidth. Since $K_d^2 = \frac{\Delta V_{\text{rms}}^2}{\Delta f_{\text{rms}}^2}$, then $S_{\Delta f} = \frac{\Delta V_{\text{rms}}^2}{K_d^2}$ or in logarithmic form

$$S_{\Delta f}(f_m) \text{ [dBHz/Hz]} = S_v(f_m) \text{ [dBm]} - K_d \text{ [dBm]}$$

Since phase noise is typically defined for a 1 Hz bandwidth, the measured noise power must be converted to 1 Hz noise bandwidth data. This is a simple power normalization process, where the noise bandwidth correction, NBW(dB), is simply

$$\text{NBW [dB]} = 10 \log \frac{B_m}{1 \text{ Hz}}$$

where B_m is the actual measurement bandwidth.

The correction NBW [dB] is subtracted from the measured data to convert the measured phase noise to a 1 Hz noise bandwidth. The power spectral density of frequency fluctuations is then given by

$$S_{\Delta}(f_m) [\text{dBHz/Hz}] = S_v(f_m) - K_d - \text{NBW}$$

or, using the relations developed in Chapter 2, the power spectral density of phase fluctuations is given by

$$S_{\phi}(f_m) [\text{dB}\pi/\text{Hz}] = S_v(f_m) - K_d - \text{NBW} - 20 \log f_m$$

For peak phase deviations $\ll 1$ radian, the single sideband phase noise to carrier ratio is given by,

$$\mathcal{L}(f_m) [\text{dBc/Hz}] = S_v(f_m) - K_d - \text{NBW} - 20 \log f_m - 3 \text{ dB.}$$

For HP analog spectrum analyzers the noise bandwidth is $10 \log(1.2 \cdot \text{RBW})$ where RBW is the resolution bandwidth indicated on the front panel.

4 HP 11729C Theory of Operation and Measurement Considerations

The HP 11729C Carrier Noise Test Set implements the delay line/mixer frequency discriminator for phase noise measurement on sources from 10 MHz to 18 GHz. It can also be used for the phase detector method (see HP Product Note PN 11729B-1, HP Lit. #5952-8286). This chapter explains how the HP 11729C makes measurements using the delay line/mixer frequency discriminator and provides typical system sensitivity of better than -140 dBc/Hz at a 1 MHz offset from a 10 GHz source.

GENERAL OPERATION

The HP 11729C Carrier Noise Test Set uses an internal low noise microwave reference signal to down-convert the test signal to an IF frequency. The resulting IF signal is amplified and then applied to a delay line/mixer frequency discriminator where the phase noise is demodulated and made available for analysis.

The HP 11729C supplies everything needed for a delay line discriminator measurement except the delay line and the spectrum analyzer. The Carrier Noise Test Set includes the phase detector, the quadrature monitor, and both the low noise IF and baseband amplifiers. Because the discriminator operates at an IF frequency below 1.28 GHz, common coaxial cable such as RG223 can be used for the delay line. Also because the output of the discriminator is amplified, almost any available low frequency spectrum analyzer can be used. The HP 11729C provides all this in a compact package that is HP-IB controllable, making automatic phase noise measurements easy.

The HP 11729C features a major new contribution with its improved low noise microwave signal needed for the down conversion to the IF frequency. Remember from Chapter 2 that the noise on this reference signal is down-converted and appears on the IF signal. This means that the signal used for down-conversion must have very low phase noise or its noise will mask the noise of the source under test. The generation of this signal leads to the first n of the HP 11729C. See Figure 4.1 for a simplified block diagram of the HP 11729C. For a more complete block diagram see Figure 4.4.

Figure 4.1. HP 11729C simplified block diagram.

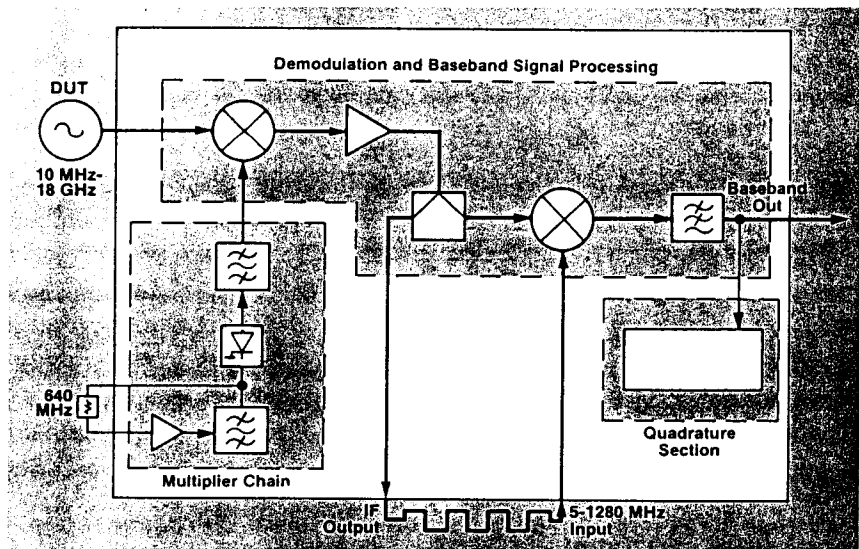

MULTIPLIER CHAIN

To obtain a low noise microwave signal, the HP 11729C requires a fixed frequency 640 MHz drive signal for multiplication to microwave.

There are two ways to obtain the 640 MHz signal. One is to use the auxiliary 640 MHz fixed frequency output of the HP 8662/8663 Synthesized Signal Generator.

(The HP 8662/8663 are used with the HP 11729C to make phase noise measurements using the phase detector method, see PN 11729B-1.) If an HP 8662/8663 is part of the measurement system, the auxiliary 640 MHz output is an excellent low noise drive signal for the HP 11729C.

However, for a low-cost, stand-alone system, the HP 11729C can be configured to generate its own 640 MHz signal internally. A Surface Acoustic Wave (SAW) oscillator can be created by connecting the 640 MHz output to the 640 MHz input on two rear panel connectors of the HP 11729C with the included cable as indicated in Figure 4.2. (Do not substitute cables as the physical length affects the oscillating frequency.)

Figure 4.2. HP 11729C cable hookup for 640 MHz self-generation.

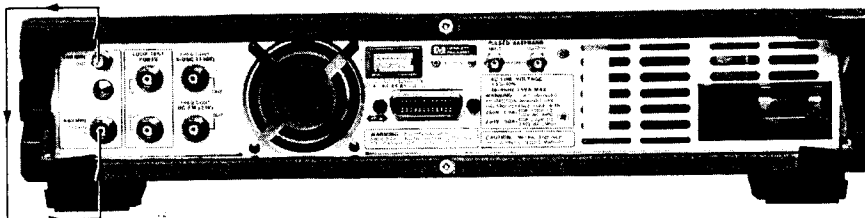

The 640 MHz reference signal determines the HP 11729C system noise floor. Figure 4.3 shows the noise floor of the HP 11729C at 10 GHz when in the SAW oscillator mode or when using the signal from the HP 8662/8663. Note that the noise floor for the SAW oscillator mode is lower from 70 kHz to 10 MHz, and the noise floor provided by the HP 8662/8663 is lower from 70 kHz and closer.

Figure 4.3. Noise floor of HP 11729C phase noise test system.

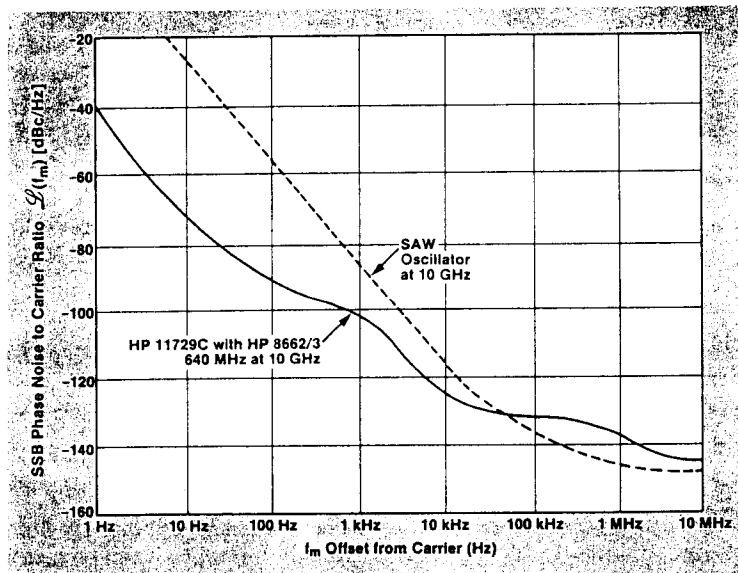

The standard HP 11729C uses 8 microwave transfer switches with 7 bandpass filters installed (Figure 4.4). This allows it to down-convert test signals from 10 MHz to 18 GHz and to switch from band-to-band under computer control for automatic testing. For test frequencies less than 1.28 GHz, one switch bypasses the microwave mixer and applies the test signal directly to the IF amplifier. A single filter version of the HP 11729C, for narrowband or single test frequency applications, retains the bypass switch for low frequencies and one user-defined bandpass filter, at lower cost.

Once the HP 11729C has generated the very low noise signal within 1280 MHz of the DUT frequency, the microwave test signal is down-converted and processed.

DEMODULATING AND BANDPASS SIGNAL PROCESSING SECTION

First Down-conversion (Microwave mixer)

The selected harmonic of the 640 MHz drive signal mixes with the microwave source under test in the input mixer, yielding an IF frequency between 10 to 1280 MHz. Because of the low signal level of the higher frequency comb lines, the source under test must provide the local oscillator (LO) drive power. A signal level of between +7 and +20 dBm (for input signals >1.28 GHz) is appropriate. For DUT frequencies between 10 MHz and 1.28 GHz, the signal is input directly into the IF amplifier and should have a signal level of between -5 and +10 dBm.

IF Processing and the Frequency Discriminator

The resultant IF signal is amplified and then split into two paths. One of the signals supplies the local oscillator drive to the RF double-balanced mixer that will be used as the phase detector. The other signal is output to the front panel of the HP 11729C for monitoring or in this case to be connected to the external delay line. After passing through the delay line, the signal returns to the R port of the RF mixer (5 to 1280 MHz input).

Typical values of the IF signal level out of the front panel are between +9 and +14 dBm, depending on the IF frequency. The minimum specified value for all IF es is +7 dBm. A high level IF signal is important as it allows the use of longer delay lines for improved sensitivity.

The resultant IF signal phase correlates against a delayed version of itself. If the two signals are 90° out-of-phase (phase quadrature), the RF mixer operates as the system phase detector. If the frequency discriminator has the required sensitivity, the resulting baseband signal represents the frequency noise of the microwave test source.

Baseband Signal Processing

A 15 MHz (3 dB BW) Low-Pass Filter (LPF) processes the baseband signal to remove the mixer sum products and the LO feedthrough. The baseband signal is further processed through a Low Noise Amplifier (LNA), and then applied to the <10 MHz Noise Spectrum Output for viewing with a spectrum analyzer.

The amplifier has approximately 40 dB of gain (coupled into 50Ω), and a bandwidth of about 10 Hz to 30 MHz. Typical flatness is less than 1 dB and the noise figure is <2.0 dB. The LNA permits the HP 11729C detected noise output to be viewed on a standard lab spectrum analyzer at the <10 MHz output.

If the IF frequency is less than 20 MHz, additional low-pass filtering is needed to remove the unwanted mixer products and LO feedthrough. The HP 11729C provides a 1.5 MHz low-pass filter that allows IF frequencies of 10 MHz or greater to be processed. The resulting noise signal is available at the <1 MHz Noise Spectrum Output for viewing on a low frequency spectrum analyzer. The <1 MHz signal is not amplified by the LNA. If a lower IF frequency is critical, additional low-pass filtering can be user added.

The IF amplifier of the HP 11729C is bandwidth limited to 1500 MHz. This is not a problem as the comb line filters are chosen such that the IF frequency is never more than 1280 MHz. For example the 9.6 GHz filter covers test frequencies from 8.32 GHz to 10.88 GHz (excluding ±10 MHz centered on 9.6 GHz). The frequency of the

selected comb line, as well as the range of input signals that can be down-converted with each comb line, are indicated on the front panel of the HP 11729C.

Figure 4.4. HP 11729C Carrier Noise Test Set.

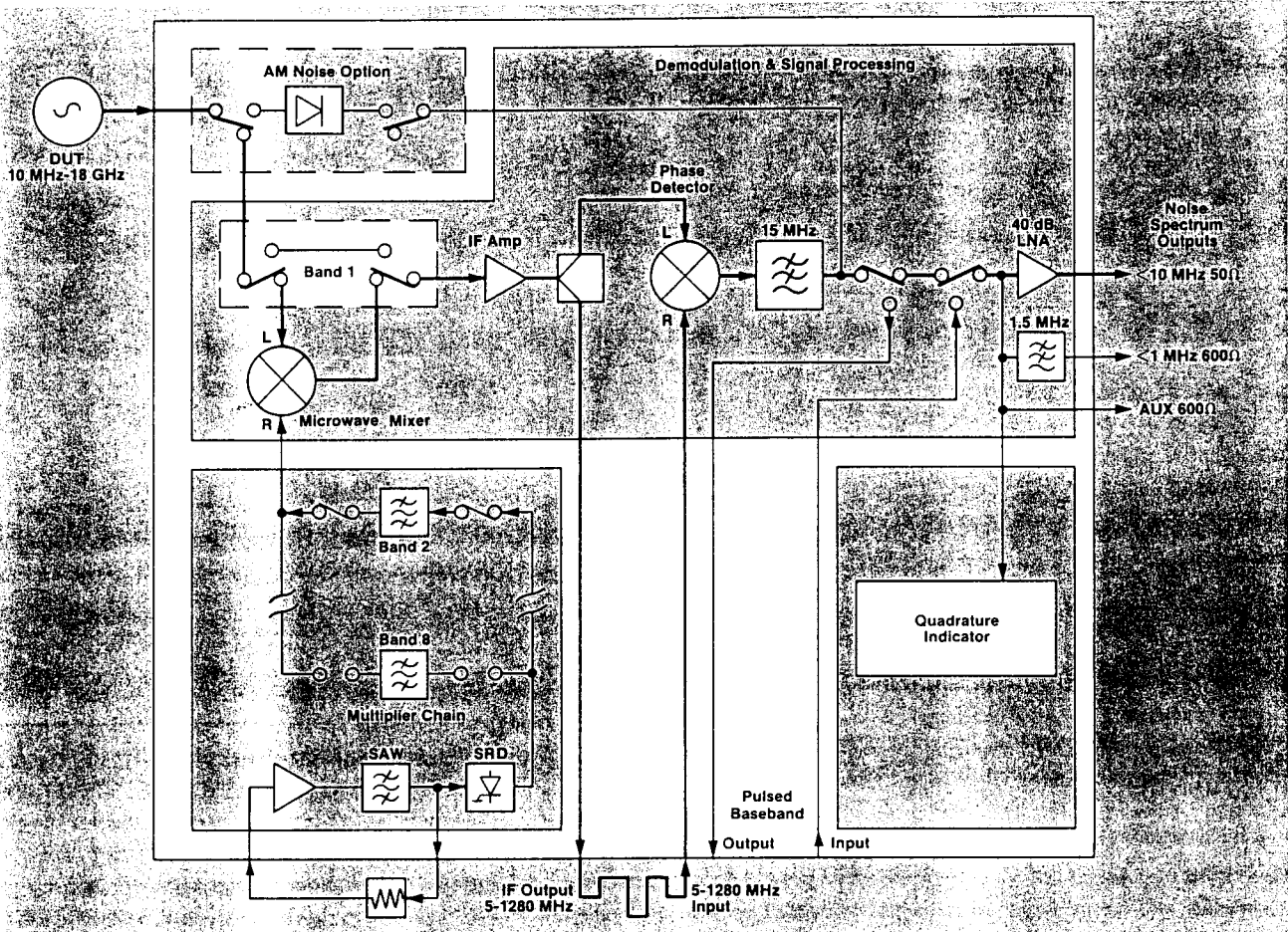

PHASE-LOCK LOOP/ QUADRATURE SECTION

The inputs to the phase detector must be maintained in quadrature for the duration of the measurement. Quadrature can be observed on the red and green LED display of the front panel of the HP 11729C or can be monitored over the HP-IB bus during automated measurements. The phase-lock loop circuitry is not used when implementing the frequency discriminator because the DUT signal is phase detected against itself. However the quadrature indicator remains active and can be used to insure that quadrature is maintained.

5 Making Frequency (Phase) Noise Measurements with the HP11729C

This chapter integrates the theory of the delay line/mixer frequency discriminator (Chapter 3) and its implementation in the HP 11729C (Chapter 4) into procedures for making phase noise measurements on microwave sources. The measurement procedure breaks down into three easy steps: 1) system set-up; 2) system calibration, and 3) noise measurement. Specific instrument operation instructions are given for the HP 11729C Carrier Noise Test Set.

SYSTEM SET-UP

The delay line/mixer implementation of a frequency discriminator with the HP 11729C is shown in Figure 5.1. Note that a phase shifter or a line stretcher may be required to obtain quadrature if the source frequency is not adjustable. The maximum frequency adjustment Δf_0 required of the source can be determined from the following equation

$$\Delta f_0 = 1/4\tau_d$$

Figure 5.1. System set-up for making a delay line/mixer frequency discrimination phase noise measurement.

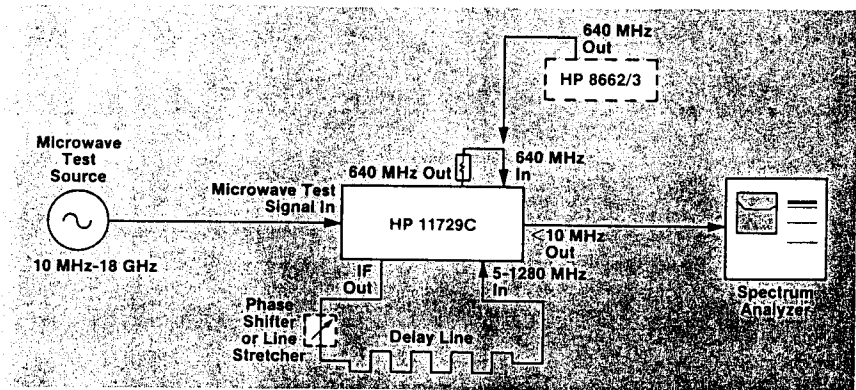

The Source

The frequency of the test source determines the filter band of the HP 11729C to be used. Because the source must provide the local oscillator drive signal (LO) to the microwave mixer for frequencies above 1.28 GHz, the source output power should be between +7 dBm and +20 dBm. For frequencies below 1.28 GHz the microwave mixer is bypassed and the source output power should be between -5 dBm and +10 dBm (with an optimal level from -2 to +3 dBm). Power levels below +7 dBm (-5 dBm < 1.28 GHz) can be used with a degradation in the system noise floor. Keep the cable length from the source under test to the HP 11729C short to reduce cable attenuation. This will help provide the necessary LO level and also help prevent system noise floor degradation.

The 640 MHz Drive Signal

The 640 MHz drive signal required by the HP 11729C can be self-generated or obtained from an HP 8662/8663 Synthesized Signal Generator. By using the self-generated 640 MHz drive signal, a lower system noise floor results from 70 kHz to 10 MHz. (Typically the phase detector method is used if close-in sensitivity is needed. See HP product note PN 11729B-1 Phase Noise Characterization of Microwave Sources—Phase Detector Method.) To use the self-generated 640 MHz drive signal, connect the supplied cable between the rear panel 640 MHz output and 640 MHz input ports. To use the 640 MHz drive signal from an HP 8662/8663 connect the 640 MHz output from the rear of the HP 8662/8663 to the 640 MHz input port on the rear panel of the HP 11729C. Then cap the 640 MHz output port on the HP 11729C with the 50 Ω SMA termination provided.

The Delay Line

As developed in Chapter 3, system sensitivity depends on both the length and attenuation of the delay line. Because the HP 11729C down-converts the microwave signal to an IF frequency of less than 1.28 GHz, the delay line can be common coaxial or semi-rigid cable. Coaxial cable such as RG 223 provides about 1.5 ns delay per foot of cable.

Because a discriminator is typically used only to offsets of less than $1/2\tau_d$, the maximum delay to be used is determined by the highest offset frequency of interest. For example, if measurements are desired of an offset frequency (f_m) of 10 MHz, the delay must be less than $1/2 f_m = 1/2(10 \text{ MHz}) = 50 \text{ ns}$.

An easy way to determine the delay τ for an unknown length of cable is to tune the source frequency so that phase quadrature occurs, then continue tuning the source until quadrature is again established. The delay τ_d is equal to $1/2(\Delta f_o)$ where Δf_o is the frequency difference between the two quadrature points.

After choosing a cable length, measure the signal power out of the HP 11729C IF output through the length of cable with a spectrum analyzer. As developed in Appendix C, optimum sensitivity results if the power out of the delay is approximately -5 dBm . If the power out goes below -5 dBm , the delay line attenuation is too great and system sensitivity degrades. Either use a delay line with less attenuation or shorten the delay line until the signal power equals -5 dBm . This increases the system sensitivity and also increases the offset frequency to which measurements can be made without corrections to the discriminator transfer response.

Because cable attenuation is frequency dependent, system sensitivity can be improved by reducing the IF frequency out of the HP 11729C. This technique is only possible by tuning the source under test. The reduction of delay line attenuation translates directly into increased system sensitivity. Figure 5.2 shows typical lengths of RG 223 coaxial cable versus HP 11729C IF frequencies that provide optimum sensitivity. Figure 5.3 shows the sensitivity of the HP 11729C implementation of the delay line frequency discriminator using a 100 ns RG 223 delay line.

Figure 5.2. Optimum system sensitivity/delay line length vs. IF frequency.

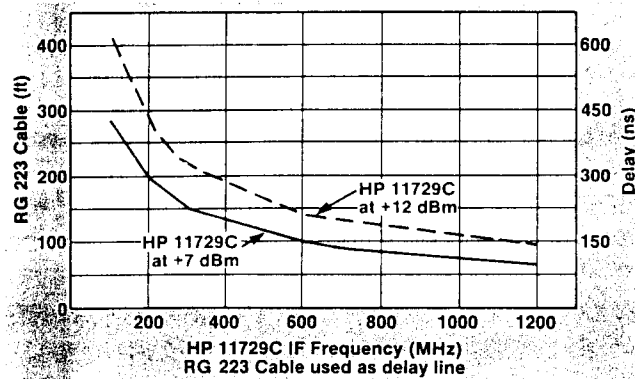
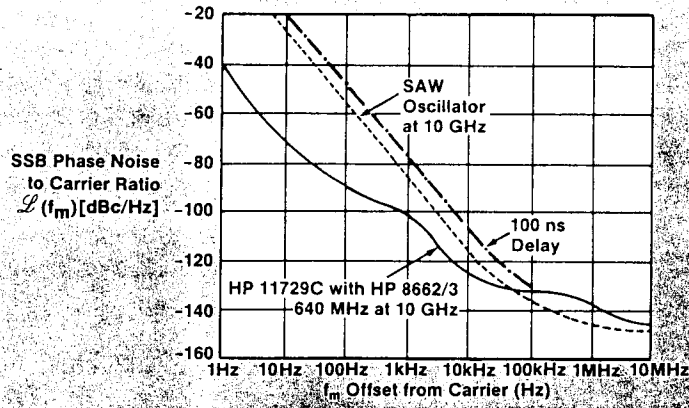

Figure 5.3. Typical HP 11729C sensitivity with a 100 ns delay line.



System Operation

Make the following tests to insure that the HP 11729C system is operating as expected. Disconnect the delay line from the IF output port on the HP 11729C and measure the IF frequency and the IF power with an RF spectrum analyzer. The IF frequency should be equal to the source under test frequency minus the filter center frequency.

$$IF = f(\text{source}) - f(\text{filter})$$

The IF output power should be greater than or equal to +7 dBm. After the proper IF signal is obtained, reconnect the delay line between the IF output and the 5-1280 MHz input ports on the HP 11729C. Check to see that quadrature can be established by adjusting the source frequency, the phase shifter or the line stretcher. The green LED in the PHASE LOCK display on the HP 11729C front panel indicates phase quadrature. After obtaining quadrature the system is ready to be calibrated.

SYSTEM CALIBRATION

Usually the easiest way to calibrate the frequency discriminator is to measure the system response to a known signal. This establishes a reference for subsequent measurements. System calibration consists of the following:

- generation and measurement of the calibration signal.
- measuring system response to the calibration signal.
- calculating the discriminator constant K_d .

The Calibration Signal

A signal with a single FM tone will be used as the calibration signal. Often the source under test itself can be modulated to produce this signal. If not, an alternate source can be substituted for the test source. The substitution method can be made either with a microwave source or at the IF frequency (see Figures 5.4 and 5.5).

Figure 5.4. Calibrating the HP 11729C delay line/mixer frequency discriminator with a microwave source.

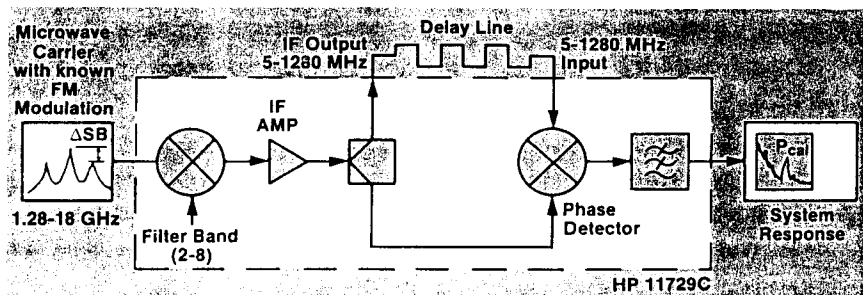
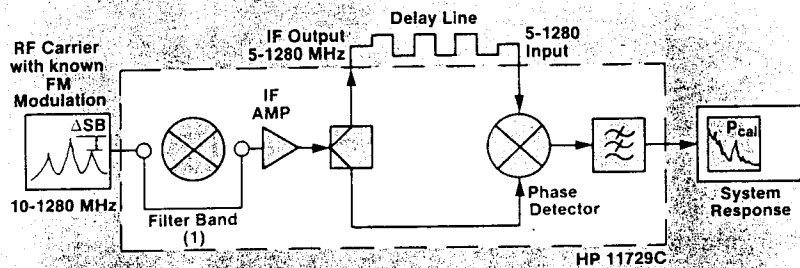

Figure 5.5. Calibrating the HP 11729C delay line/mixer frequency discriminator with an RF source.



The modulation index on the calibration signal should be set to <0.2 radians (to satisfy the small angle criterion and the relation between $S_{\Delta f}(f_m)$ and $\mathcal{L}(f_m)$ as developed in Chapter 2). The modulation index β is the peak FM deviation (Δf_{pk}) divided by the FM rate (f_m).

$$\beta = \text{modulation index} = \frac{\Delta f_{pk}}{f_m}$$

Remember:

$$\mathcal{L}(f_m) = \frac{S_{\Delta f}(f_m)}{2f_m^2} = \frac{\Delta f_{rms}^2}{2f_m^2} \quad (\text{for } m < 0.2 \text{ rad})$$

An FM rate of 1 kHz with a peak deviation of 0.1 kHz yields a modulation index of 0.1 radian which should result in a sideband to carrier ratio of -26 dBc. Record the FM rate used in the calibration signal ($f_{mcal} = \text{---}$). See Appendix D for a more complete discussion of the calibration theory.

If the source under test cannot be modulated, the system can still be calibrated by substituting a modulated microwave source at the same level and frequency. The HP 8683/8684 Signal Generator and the HP 8672/8673 Synthesized Signal Generator are all good microwave sources that could be used.

If a modulated microwave source is not available, then calibration can still be accomplished by using a modulated RF source substituted at the IF frequency. Set the RF calibration source to the HP 11729C IF frequency, at a level of -10 dBm with FM modulation applied ($\beta < 0.2$ radians). Setting the signal level to -10 dBm improves the calibration accuracy by closely matching the signal level of the down-converted microwave test signal. A signal level between -3 and $+2$ dBm gives best results for test sources that use the <1280 MHz filter band directly. The HP 8662/8663, 8640, 8642, 8656, and 8660 all have internal modulation capabilities and can be used as the RF calibration source.

Measure the sideband to carrier level of the calibration signal with a spectrum analyzer, and record this ratio ($\Delta SB_{cal} = - \text{---}$ dBc).

System Response

The second step in calibrating the system measures its response to the signal created previously. Connect the calibration signal to the Microwave Test Signal input port on the HP 11729C and select the appropriate filter band. If RF calibration is used, select the 0.01-1.28 GHz band. Before measuring the response, check to see that the system indicates phase quadrature by the green LED in the Phase Lock Indicator on the front panel of the HP 11729C. Set quadrature by adjusting the calibration source frequency, adjusting the phase shifter, or adjusting the line stretcher.

Once quadrature has been obtained, measure the system response to the calibration signal. The demodulated calibration signal will have a sharp response at the baseband frequency corresponding to the FM rate, as shown in Figure 5.6. Measure and record the power level, $P_{cal} = \text{---}$. If possible, adjust the spectrum analyzer input sensitivity so that the spike is at the top of the display. Leave the input sensitivity at this setting to help improve measurement accuracy, by avoiding extra corrections for display attenuation steps.

Figure 5.6. System response to calibration signal.

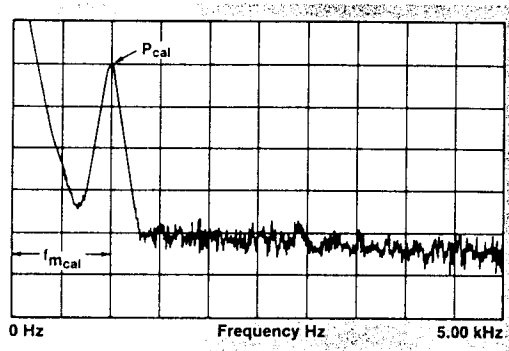

Discriminator Constant (K_d)

To complete the calibration procedure, calculate the discriminator constant K_d . As explained in Appendix D,

$$K_d [\text{dBm}] = P_{cal} [\text{dBm}] - [3 \text{ dB} + 20 \log f_{m_{cal}} + \Delta SB_{cal}]$$

Calculate and record the discriminator constant.

$$K_d [\text{dBm}] = \text{---}$$

MEASURING THE FREQUENCY (PHASE) NOISE

After completing calibration, the source frequency noise can be measured by:

- a) Measuring the frequency noise.
- b) Applying measurement corrections.
- c) Converting to other phase noise units if desired.

Measuring the Frequency Noise

If an alternate source was used for calibration, reconnect the test source to the HP 11729C Microwave Test Signal input. If an RF source was used, select the appropriate filter band on the HP 11729C to down-convert the test source. If the test source itself was used for calibration, remove the FM modulation from it. Adjust the source frequency, phase shifter, or line stretcher as necessary to re-establish phase quadrature. Quadrature should be maintained throughout the measurement procedure.

Set up the spectrum analyzer span to cover the offset frequencies of interest. The input sensitivity of the spectrum analyzer should not be changed from the calibration procedure if possible. Select a resolution bandwidth RBW that is in keeping with the chosen frequency span. For example, a good choice of RBW is 1 kHz for a span from 10 kHz to 100 kHz, or 10 kHz for 100 kHz to 10 MHz.

Because noise is a random quantity, some sort of averaging is desirable. If available, digital averaging can be selected or some analog averaging can be done by reducing the video BW on the spectrum analyzer. The HP 8566 Spectrum Analyzer is ideally suited.

After averaging, take a reading from the spectrum analyzer in dBm at the offset frequency of interest, noting the resolution bandwidth setting. Set other frequency spans and make measurements as desired. Record the values from the spectrum analyzer display (P_{noise}), the offset frequencies they were taken at (f_m), and the resolution bandwidths (RBW) used to measure the value.

$$P_{\text{noise}} = \text{---} [\text{dBm}] \quad f_m = \text{---} [\text{Hz}] \quad \text{RBW} = \text{---} [\text{Hz}]$$

Noise levels measured within 10 dB of the bottom of the spectrum analyzer's display can degrade the measurement accuracy. If possible, increase the spectrum analyzer input sensitivity and repeat the measurement. This should not be a problem if the calibration signal P_{cal} is brought to the top of the CRT as discussed in the calibration procedure.

Measurement Corrections

Because the spectrum analyzer responds differently to sine waves than to random noise, two corrections must be made to the measured data. The first correction accounts for the log-shaping and detection circuitry of an analog spectrum analyzer. This correction (SA) is +2.5 dB for HP analog spectrum analyzers (see HP application note AN 150-4).

The second correction normalizes the measurement to a 1 Hz noise bandwidth (NBW) and accounts for the spectrum analyzer resolution bandwidth used during the noise measurements. This correction (NBW) is $10 \log(1.2 \cdot \text{RBW})$ to the first approximation for HP spectrum analyzers, where RBW is the indicated resolution bandwidth on the analyzer.

As developed in Chapter 3, $S_{\Delta f}(f_m)$ equals the spectrum analyzer display $P_{\text{noise}}(f_m)$ minus the discriminator constant K_d . Including the measurement corrections to the original equation yields:

$$S_{\Delta f}(f_m) [\text{dBHz/Hz}] = P_{\text{noise}}(f_m) [\text{dBm}] - K_d [\text{dBm}] + \text{SA} [\text{dB}] - \text{NBW} [\text{dB}]$$

where from Appendix D

$$K_d [\text{dBm}] = P_{\text{cal}} [\text{dBm}] - (\Delta \text{SB}_{\text{cal}} + 20 \log f_{m_{\text{cal}}} + 3) [\text{dB}].$$

Conversion to Other Units

To convert $S_{\Delta f}(f_m)$ to other phase noise units, use the relationships developed in Chapter 2 and the two previous equations. $\mathcal{L}(f_m)$ and $S_{\phi}(f_m)$ can be derived as

$$\begin{aligned} \mathcal{L}(f_m) [\text{dBc/Hz}] &= P_{\text{noise}} [\text{dBm}] - P_{\text{cal}} [\text{dBm}] + \Delta \text{SB}_{\text{cal}} [\text{dBc}] - 20 \log \frac{f_m}{f_{m_{\text{cal}}}} - \text{NBW} [\text{dB}] + \text{SA} [\text{dB}] \\ &= S_{\Delta f}(f_m) - 20 \log f_m - 3 \text{ dB} \end{aligned}$$

$$\begin{aligned} S_{\phi}(f_m) [\text{dB}/\text{Hz}] &= P_{\text{noise}} [\text{dBm}] - P_{\text{cal}} [\text{dBm}] + \Delta \text{SB}_{\text{cal}} [\text{dBc}] - 20 \log \frac{f_m}{f_{m_{\text{cal}}}} - \text{NBW} [\text{dB}] + \text{SA} [\text{dB}] + 3 \text{ dB} \\ &= S_{\Delta f}(f_m) - 20 \log f_m \end{aligned}$$

Figures 5.7, 5.8, and 5.9 show example calculations required to obtain $S_{\Delta f}(f_m)$, $S_{\phi}(f_m)$, and $\mathcal{L}(f_m)$ using data from a free running VCO. Calibration was made with a 1 kHz tone ($f_{m_{\text{cal}}}$) with a modulation index of 0.2 rad ($\Delta \text{SB}_{\text{cal}} = -20 \text{ dBc}$). The system response P_{cal} was -54.6 dBm and the test source frequency noise (P_{noise}) at a 1 MHz offset was -71.5 dBm . The resolution bandwidth (RBW) of the spectrum analyzer used during the measurement was 300 Hz. Note each result though apparently different represents the phase noise for the same VCO expressed in different units.

Figure 5.7. Computing $S_{\Delta f}(f_m)$ [dBHz/Hz] from the spectrum analyzer display.

1) Establish known sideband/carrier ratio	$\Delta SB_{cal}(f_m) = -20$ dBc
2) Record $f_{m_{cal}}$	$f_{m_{cal}} = 1$ kHz
3) Measure system response	$P_{cal} = -54.6$ dBm
4) Determine discriminator constant	$K_d[\text{dBm}] = P_{cal}[\text{dBm}] - (\Delta SB_{cal} + 20 \log f_{m_{cal}} + 3)[\text{dB}]$ $K_d = -97.6$ dBm
5) Measure P_{noise} (in known RBW)	$P_{noise} = -71.5$ dBm
6) Noise Bandwidth correction	$NBW[\text{dB}] = 10 \log RBW \cdot 1.2$ $NBW = 25.5$ dBHz
7) Spectrum Analyzer correction	$S/A = 2.5$ dB*
8) $S_{\Delta f}(f_m)[\text{dB}] = (P_{noise} - K_d + S/R - NBW)$	$S_{\Delta f}(f_m) = 3.1$ dBHz/Hz**
$S_{\Delta f}(f_m)[\text{dB}] = (-71.5) - (-97.6) + 2.5 - 25.5$	

Figure 5.8. Computing $S_{\phi}(f_m)$ [dBr/Hz] from the spectrum analyzer display.

1) Establish known sideband/carrier ratio	$\Delta SB_{cal}(f_m) = -20$ dBc
2) Record $f_{m_{cal}}$	$f_{m_{cal}} = 1$ kHz
3) Measure system response	$P_{cal} = -54.6$ dBm
4) Measure P_{noise} (in known RBW)	$P_{noise} = -71.5$ dBm
5) Offset frequency	$f_{m_{offset}} = 1$ MHz
6.) Noise Bandwidth correction	$NBW[\text{dB}] = 10 \log RBW \cdot 1.2$ $NBW = 25.5$ dBHz
7) Spectrum Analyzer correction	$S/A = 2.5$ dB*
8) $S_{\phi}(f_m) = P_{noise} - P_{cal} + \Delta SB_{cal} - 20 \log \frac{f_{m_{offset}}}{f_{m_{cal}}} - NBW + S/A + 3$ dB	
$(-71.5) - (-54.6) + (-20) - 20 \log \frac{10^6}{10^3} - 25.5 + 2.5 + 3$	$S_{\phi}(f_m) = -116.9$ dBr/Hz**

Figure 5.9. Computing $\mathcal{L}(f_m)$ [dBc/Hz] from the spectrum analyzer display.

1) Establish known sideband/carrier ratio	$\Delta SB_{cal}(f_m) = -20$ dBc
2) Record $f_{m_{cal}}$	$f_{m_{cal}} = 1$ kHz
3) Measure system response	$P_{cal} = -54.6$ dBm
4) Measure P_{noise} (in known RBW)	$P_{noise} = -71.5$ dBm
5) Offset frequency	$f_m = 1$ MHz
6) Noise Bandwidth correction	$NBW[\text{dB}] = 10 \log RBW \cdot 1.2$ $NBW = 25.5$ dBHz
7) Spectrum Analyzer correction	$S/A = 2.5$ dB*
8) $\mathcal{L}(f_m) = P_{noise} - P_{cal} + \Delta SB_{cal} - 20 \log \frac{f_{m_{offset}}}{f_{m_{cal}}} - NBW + S/A$	
$(-71.5) - (-54.6) + (-20) - 20 \log \frac{10^6}{10^3} - 25.5 + 2.5$	$\mathcal{L}(f_m) = -119.9$ dBc/Hz**

*Correction for HP analog spectrum analyzers.

**Phase noise measured at a 1 MHz offset from the carrier.

6 Considerations in System Accuracy

After configuring a phase noise measurement system, it may be necessary to determine the accuracy of the measurement. This chapter discusses some of the elements that can affect overall system accuracy. With careful system design, phase noise measurements can be made to typical overall accuracies of less than ± 2.5 dB. Even without extensive correction routines, typical accuracies between ± 3 to ± 5 dB can be expected. The overall accuracy is a function of 1) the instrumentation used to measure the source noise, 2) certain system parameters of the HP 11729C, and 3) the measurement procedure. Looking at the individual contributions to system accuracy isolates the areas where accuracy can be improved.

THE SPECTRUM ANALYZER

The spectrum analyzer measures both the source phase noise and the calibration signal. There are several areas within the spectrum analyzer that can affect system accuracy, including:

- a) the relative amplitude accuracy;
 - b) the resolution bandwidth of the spectrum analyzer used to measure the noise;
 - c) the relative IF bandwidth gain accuracy;
 - d) the spectrum analyzer frequency response (flatness).
-

Relative Amplitude Accuracy

The overall level accuracy of a spectrum analyzer can be as large as ± 6 dB. However, by using the analyzer in a relative mode and by limiting the number of analyzer parameters changed between calibration and measurement, the accuracy can be improved to between ± 0.4 and ± 1.5 dB. See HP application note AN 150-8 "Spectrum Analysis Accuracy Improvement" (HP Lit. #5952-1147) for more information.

Resolution Bandwidth Accuracy

Because phase noise is typically specified on a per hertz basis, an accurate measure of the bandwidth used during the measurement is needed. This noise bandwidth (NBW) depends on the resolution bandwidth (RBW) of the particular spectrum analyzer used during the phase noise measurement.

There are 3 methods of determining the noise bandwidth for HP analog spectrum analyzers. The least accurate is to take the displayed resolution bandwidth setting and multiply it by 1.2. (RBW on an HP spectrum analyzer typically exhibit accuracy of $\pm 10\%$.) A more accurate estimation of the noise bandwidth could be obtained by measuring the 3 dB resolution bandwidth and multiplying it by 1.2.

The most accurate method of determining the noise bandwidth would be to actually characterize the resolution bandwidth response to random noise (see HP AN 150-4). The accuracy of such a measured noise bandwidth can be typically ± 0.2 dB when the 3 dB resolution bandwidth of the spectrum analyzer is measured.

The IF Gain Accuracy

The relative IF gain accuracy results from changes in the resolution bandwidth gain and depends on the particular spectrum analyzer. Typically its contribution remains small (± 0.05 dB) and time should not be spent trying to reduce it.

Spectrum Analyzer Frequency Response

Typically the amplitude response of the spectrum analyzer can vary ± 0.5 to ± 1.5 dB over its entire frequency range. However, by using only a small portion of the range, the error will be less. Check the specifications of the analyzer to determine the actual inaccuracy. The frequency response for an HP 8566A Spectrum Analyzer is ± 0.6 dB over the 100 Hz to 2.5 GHz range. The actual error will be closer to ± 0.3 dB because only a narrow portion of this range is used (100 Hz to 10 MHz).

SYSTEM PARAMETERS of
the HP 11729C

The system parameters of the HP 11729C that can affect measurement accuracy are:

- a) the frequency discriminator flatness;
- b) baseband signal processing;
- c) the system noise floor.

Frequency Discriminator Flatness

The frequency discriminator flatness results from the phase detector flatness and the delay line attenuation slope over the input frequency range. The phase detector in the HP 11729C introduces typical error of ± 1.0 dB (10 MHz to 1.28 GHz range). Over the same range the attenuation of a 50 ns delay line (34 ft. of RG 223) can vary as much as ± 2.5 dB.

However, the error is actually much less because both the phase detector and the delay line must only operate over a ± 10 MHz range centered around the IF frequency. By recalibrating the system for each new test frequency that yields a different IF frequency into the HP 11729C phase detector, the error can be reduced to less than ± 0.2 dB. Much of this inaccuracy results from the variation in delay line attenuation and can be further reduced by using delay lines with less attenuation or by recalibrating the system with different FM tones (keeping the modulation index constant) for the offset frequencies of interest.

Baseband Signal
Processing Flatness

The HP 11729C signal processing section typically provides flatness to within ± 1.0 dB (1 Hz to 10 MHz). If a very flat spectrum analyzer or other measurement instrument is available, this inaccuracy can be reduced by one of two methods. If a noise measurement at only a few offset frequencies is desired, a calibration step could be done at each offset frequency of interest.

For a more complete error correction, the HP 11729C signal processing section can be swept-characterized. This swept characterization as a function of frequency may be done by applying a varying frequency into the signal processing section and measuring the resultant output signals at the <1 MHz and <10 MHz Noise Spectrum Output ports. Note the source used for this characterization must be flatter than the filters and low noise amplifier in the HP 11729C.

System Noise Floor

The noise measured at the output of the frequency discriminator comes from the noise on the source being tested, the noise of the 640 MHz source used by the HP 11729C to down convert the test source, and the two-port noise of the HP 11729C. Letting $L_{HP\ 11729C}$ equal the total HP 11729C system noise (two-port and contribution from the 640 MHz signal) the error is given by

$$\text{error (dB)} = 10 \log \left(1 + \text{antilog} \frac{L_{DUT} - L_{HP\ 11729C}}{10} \right)$$

The following table lists this error for several values of noise power differences.

$L_{DUT} - L_{HP\ 11729C}$ (dB)	0	1	2	3	4	5	10	15
correction (dB)	3.0	2.5	2.1	1.8	1.5	1.2	0.4	0.2

This error can be corrected by actually characterizing the noise of the HP 11729C system, and then using this known value of noise to correct for the measured value as shown in the table.

MEASUREMENT PROCEDURE

The care used when actually making a measurement with the frequency discriminator has a direct effect on the measurement accuracy. The areas that can affect the measurement include:

- a) quadrature maintenance;
- b) system calibration;
- c) the randomness of noise.

Quadrature Maintenance

Because the discriminator method is a single oscillator technique, quadrature is easily maintained for most sources. The HP 11729C provides a monitor to allow constant quadrature verification. As developed in Appendix E, close phase quadrature maintenance can result in uncertainties of less than ± 0.05 dB.

System Calibration

The accuracy of the signal used for calibration also contributes to the uncertainty of the phase noise measurement. Because the spectrum analyzer measures the calibration signal, its uncertainty is the same as indicated previously (typically between ± 0.4 and ± 1.5 dB). Since measurement of the calibration signal gives a relative measurement and is viewed in a small portion of the available spectrum analyzer dynamic range, the error is typically closer to ± 0.4 dB.

If calibration uses an alternate source, additional error is introduced because the carrier frequency and power level cannot be matched exactly. Because the signal of the test source before the splitter is not directly accessible in the HP 11729C, the power levels must be matched before they enter the HP 11729C or at the IF output. Typical accuracies of ± 0.2 dB can be obtained if only minor attempts are made to match the source and calibration signal levels.

This relatively small error results from the high gain RF amplifier before the signal splitter in the HP 11729C. This amplifier operates in compression for signals of -20 dBm or greater with a very flat output (± 0.2 dB) for signals above -5 dBm. This error can be further reduced to ± 0.05 dB by accurately matching the power levels of the test source and calibration source at the IF output of the HP 11729C with a power meter.

Because the calibration information comes from a relative measurement (sideband to carrier ratio), mismatch has no effect on system accuracy when an alternate source is used.

The Randomness of Noise

A phase noise measurement has an inherent amount of error because we are trying to quantize a random quantity. This error can be reduced by averaging through analog or digital means at the spectrum analyzer. A typical uncertainty of ± 0.5 dB can be achieved with averaging.

OVERALL ACCURACY

The overall accuracy for a phase noise measurement can be calculated using the individual uncertainties. First, examine the typical accuracy that can be obtained if no extra effort is made to calibrate out system errors. Assume that system noise of the HP 11729C is >15 dB below the noise of the source under test, and that the discriminator flatness doesn't contribute error because the calibration is performed at the IF of interest. Also assume that an alternate signal source will be used for calibration. The total resultant errors tabulate as follows:

	Typical Uncertainty (±dB)
1) Spectrum Analyzer	
Relative Amplitude Accuracy	1.5
Resolution Bandwidth Accuracy	0.2
IF Gain Accuracy	0.05
Spectrum Analyzer Frequency Response	1.5
2) System Parameters of the HP 11729C	
Frequency Discriminator Flatness	0.2
Baseband Signal Processing	1.0
System Noise Floor	0.0
(assuming test system noise >15 dB below source)	
3) Measurement Procedure	
Quadrature Maintenance	0.05
Calibration Signal	1.5
Alternate Source (additional error)	0.2
Random Error Due to Randomness of Noise	0.5
Total Worst Case Uncertainty ±6.7	

Accuracy Without Error Correction The typical system accuracy without extra error correction is ±6.7 dB. Potentially, some of these errors would occur in the opposite direction and cancel. Of course, the error or correction factor due to system noise varies with the relative noise level of the test source and the system.

These numbers are worst case assuming that all errors add in the worst case way. A more realistic approximation can be obtained by examining each inaccuracy and its cause to determine if it is random or systematic. Often, this results in relative measurements having errors that partially cancel out. For a probabilistic error estimate, some errors are often combined by a root sum-of-the-squares (RSS) method, instead of simple addition. Taking the RSS of the above errors gives a total inaccuracy of ±2.85 dB.

Also remember that phase noise is a random quantity of which any measurement is only an estimate. Averaging, whether video or digital, significantly improves the accuracy and repeatability of a random measurement. Though a single sweep can be measured with summation of the accuracies given above, this single sweep does not characterize the statistical randomness of the signal.

Accuracy With Error Correction Careful measurement procedures, characterization of the HP 11729C baseband signal processing section, a very low loss delay line, and careful spectrum analyzer operation (as discussed before) can reduce measurement error as indicated below.

	Typical Uncertainty (±dB)
1) Spectrum Analyzer	
Relative Amplitude Accuracy	0.4
Resolution Bandwidth Accuracy	0.2
IF Gain Accuracy	0.05
Spectrum Analyzer Frequency Response	0.5
2) System Parameters of the HP 11729C	
Frequency Discriminator Flatness	0.1
Baseband Signal Processing Flatness	0.5
System Noise Floor	0.0
(assuming test system noise >15 dB below source)	

3) Measurement Procedure	
Quadrature Maintenance	0.05
Calibration Signal	0.4
Alternate Source	0.05
Random Error Due to Randomness of Noise	0.5
<hr/>	
Total Worst Case Uncertainty ±2.75	

Phase Noise Measurement Total Uncertainty (±dB)	Linear Summation of Typical Uncertainty	RSS of Typical Uncertainty
Overall Accuracy (No effort)	6.70	2.85
Overall Accuracy (Extra Effort)	2.75	1.06

A Frequency Discriminator Transfer Response

START of signal through delay line/mixer frequency discriminator (Figure A.1).

$$V_s(t) = V_o \cos \left(2\pi f_o t + \frac{\Delta f}{f_m} \cos 2\pi f_m t \right)$$

THROUGH SPLITTER

$$V_d(t) = V_L(t) = v \cos \left(2\pi f_o t + \frac{\Delta f}{f_m} \cos 2\pi f_m t \right)$$

INTRODUCTION OF DELAY

$$V_R(t) = v \cos \left[2\pi f_o (t - \tau_d) + \frac{\Delta f}{f_m} \cos 2\pi f_m (t - \tau_d) \right] \quad (\text{Delayed Signal})$$

$$V_L(t) = v \cos \left[2\pi f_o t + \frac{\Delta f}{f_m} \cos 2\pi f_m t \right] \quad (\text{Non-Delayed Signal})$$

THROUGH MIXER

$$V_m(t) = K_\phi \left[\begin{array}{l} \text{Difference Frequency} \\ \cos \left[2\pi f_o (t - \tau_d) + \frac{\Delta f}{f_m} \cos 2\pi f_m (t - \tau_d) - 2\pi f_o t - \frac{\Delta f}{f_m} \cos 2\pi f_m t \right] + \\ \cos \left[2\pi f_o (t - \tau_d) + \frac{\Delta f}{f_m} \cos 2\pi f_m (t - \tau_d) + 2\pi f_o t + \frac{\Delta f}{f_m} \cos 2\pi f_m t \right] + \text{HARMONICS} \\ \text{Sum Frequency} \end{array} \right]$$

THROUGH FILTER

$$V(t) = K_\phi \cos \left[2\pi f_o (t - \tau_d) + \frac{\Delta f}{f_m} \cos 2\pi f_m (t - \tau_d) - 2\pi f_o t - \frac{\Delta f}{f_m} \cos 2\pi f_m t \right]$$

$$V(t) = K_\phi \cos \left[2\pi f_o (t - \tau_d - t) + \frac{\Delta f}{f_m} (\cos 2\pi f_m (t - \tau_d) - \cos 2\pi f_m t) \right]$$

$$V(t) = K_\phi \cos \left[-2\pi f_o \tau_d + 2 \frac{\Delta f}{f_m} \sin(\pi f_m \tau_d) \sin 2\pi f_m (t - \tau_d/2) \right]$$

QUADRATURE ASSUMPTION $(2\pi f_o \tau_d = (2K + 1)\pi/2) \quad K = 0, 1, 2, 3, 4, \dots$

$$V(t) = K_\phi \cos \left[-\pi/2 + 2 \frac{\Delta f}{f_m} \sin(\pi f_m \tau_d) \sin 2\pi f_m (t - \tau_d/2) \right]$$

$$V(t) = K_\phi \left[\begin{array}{l} \cos(-\pi/2) \cos \left[2 \frac{\Delta f}{f_m} \sin(\pi f_m \tau_d) \sin 2\pi f_m (t - \tau_d/2) \right] - \\ \sin(-\pi/2) \sin \left[2 \frac{\Delta f}{f_m} \sin(\pi f_m \tau_d) \sin 2\pi f_m (t - \tau_d/2) \right] \end{array} \right]$$

$$V(t) = K_\phi \sin \left[2 \frac{\Delta f}{f_m} \sin(\pi f_m \tau_d) \sin 2\pi f_m (t - \tau_d/2) \right]$$

SMALL SIGNAL ASSUMPTION For $\frac{\Delta f}{f_m} < 0.2 \text{ rad}$, $\sin \frac{(\Delta f)}{f_m} \approx \frac{\Delta f}{f_m}$

$$V(t) = K_\phi 2 \frac{\Delta f}{f_m} \sin(\pi f_m \tau_d) \sin 2\pi f_m (t - \tau_d/2)$$

TRANSFER RESPONSE

$$\Delta V = K_\phi 2 \frac{\Delta f}{f_m} \sin(\pi f_m \tau_d) = K_\phi 2\pi \tau_d \Delta f \frac{\sin(\pi f_m \tau_d)}{(\pi f_m \tau_d)} \quad (\text{For } f_m < \frac{1}{2\pi \tau_d} \quad \frac{\sin(\pi f_m \tau_d)}{(\pi f_m \tau_d)} \approx 1)$$

$$\Delta V \approx K_\phi 2\pi \tau_d \Delta f$$

$$\Delta V \approx K_d \Delta f \quad K_d = K_\phi 2\pi \tau_d \text{ [V/Hz]} \quad \text{Frequency Discriminator Constant}$$

Figure A.1. Delay line/mixer frequency discriminator.

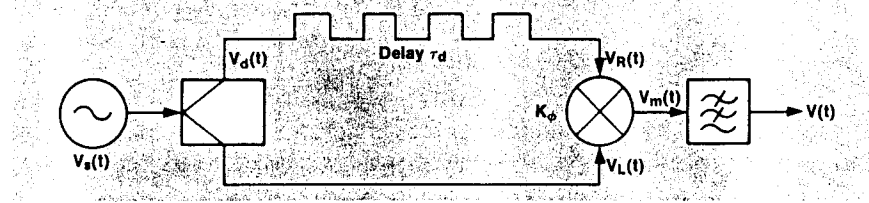

$V_s(t)$ = DUT SIGNAL (with frequency fluctuations)

$V_d(t)$ = SIGNAL TO R PORT OF MIXER (phase detector)

$V_L(t)$ = SIGNAL TO L.O. PORT OF MIXER (drives mixer)

$V_R(t)$ = DELAYED SIGNAL INTO R PORT OF MIXER

$V_m(t)$ = SIGNAL OUT OF MIXER

$V(t)$ = SIGNAL OUT OF FILTER

$$f(t) = f_o + \Delta f \sin 2\pi f_m t$$

f_o = Carrier Frequency

f_m = FM Rate

Δf = FM Peak Deviation

τ_d = Delay

K_ϕ = Phase detector constant

B A Doubled-balanced Mixer Operating as a Phase Detector

Figure B.1 shows a typical mixer-phase detector characteristic. When operated as a phase detector, the mixer outputs a voltage $V(t)$ proportional to the fluctuating phase difference between the two input signals $\phi_{LO} - \phi_{RF}$. The point of maximum phase sensitivity (the greatest voltage change per degree of phase change) and the center of the region of most linear operation occur where the phase difference between the two inputs is equal to 90 degrees, or phase quadrature.

To understand how a mixer operates as a phase detector, let's first examine a normal mixer operation (Figure B.2).

Figure B.1. Typical double-balanced mixer phase detector characteristic.

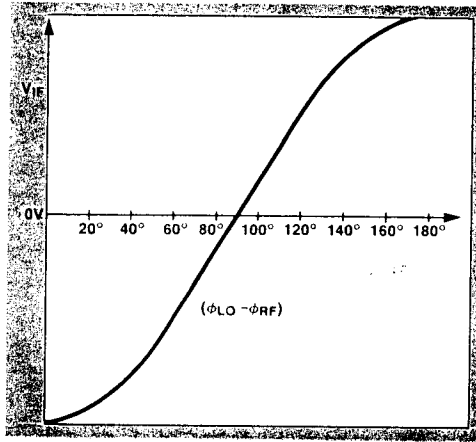
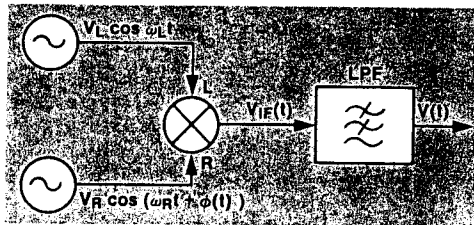

Figure B.2. Mixer operation.



Let the L port signal be described by $V_L \cos \omega_L t$, and the R port signal by $V_R [\cos \omega_R t + \phi(t)]$. Then the output of the mixer $V_{IF}(t)$ is the product of the two signals:

$$V_{IF}(t) = K_L V_R \cos [\omega_R - \omega_L] t + \phi(t)] + K_L V_R \cos [\omega_R + \omega_L] t + \phi(t)] + \dots \tag{B.1}$$

The low-pass filter in the block diagram of Figure B.2 removes the higher frequency components, leaving $V(t)$, as shown in Figure B.3.

Figure B.3. Filtered mixer output.

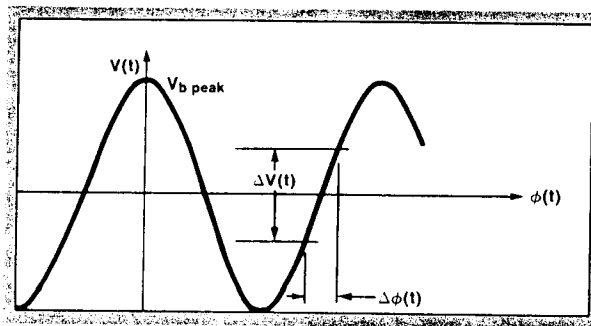

$$V(t) = K_L V_R \cos [\omega_R - \omega_L) t + \phi(t)] \quad [B.2]$$

Let the peak amplitude of $V(t)$ be defined as $V_{b \text{ peak}}$ (peak voltage of the beat signal), equal to $K_L V_R$, where K_L = mixer efficiency.

$$V_{b \text{ peak}} = K_L V_R. \quad [B.3]$$

Then,

$$V(t) = \pm V_{b \text{ peak}} \cos [\omega_R - \omega_L) t + \phi(t)] \quad [B.4]$$

When operating the mixer as a phase detector, the input signals must be at the same at is, frequency and 90° out-of-phase. That quadrature,

$$\omega_L = \omega_R, \text{ and } \phi(t) = (k + 1) 90^\circ + \Delta\phi(t) \quad [B.5]$$

Therefore, substituting in equation B.4, the output of the mixer at quadrature is described by

$$\Delta V(t) = \pm V_{b \text{ peak}} \sin \Delta\phi(t), \quad [B.6]$$

where $\Delta V(t)$ = instantaneous voltage fluctuations around $0V$, and $\Delta\phi(t)$ = instantaneous phase fluctuations.

For $\Delta\phi_{\text{peak}} \ll 1$ radian, $\sin \Delta\phi(t) \cong \Delta\phi(t)$, and equation B.6 becomes

$$\Delta V(t) = \pm V_{b \text{ peak}} \Delta\phi(t) \quad [B.7]$$

Note that this yields a direct linear relationship between the voltage fluctuations at the mixer output and the phase fluctuations of the input signals, or

$$\Delta V = K_\phi \Delta\phi$$

where $K_\phi = V_{b \text{ peak}} =$ phase detector constant (volts/radian), which is equal to the slope of the mixer sine wave output at the zero crossings.

To determine this phase detector constant, K_ϕ , the mixer is operated not in quadrature, but with the inputs at two different frequencies, resulting in $V(t)$ as described in equation B.4. The IF output signal measured on a spectrum analyzer provides the rms value of the signal ($V_{b \text{ rms}}$). The phase detector constant K_ϕ , equal to $V_{b \text{ peak}}$ is the measured value $V_{b \text{ rms}} \times \sqrt{2}$.

When the mixer is again operated as a phase detector (input signals in quadrature), the voltage output of the mixer as a function of frequency will be directly proportional to the input phase deviations from equation B.7.

$$\Delta V(f_m) = K_\phi \Delta\phi(f_m) \quad [B.8]$$

$$\Delta V(f_m) = \sqrt{2} V_{b \text{ rms}} \Delta\phi(f_m) \quad [B.9]$$

Then $\Delta\phi_{\text{rms}}(f_m)$ as measured on the spectrum analyzer is

$$\Delta\phi_{\text{rms}}(f_m) = \frac{1}{K_\phi} \Delta V_{\text{rms}}(f_m) = \frac{1}{\sqrt{2} V_{b \text{ rms}}} \Delta V_{\text{rms}}(f_m) \quad [B.10]$$

C System Sensitivity

The transfer response of the delay line/mixer frequency discriminator as developed in Appendix A is

$$\Delta V(f_m) = K_d \Delta f(f_m)$$

assuming that the offset frequency (f_m) of interest is less than $1/2 \pi \tau_d$. K_d the discriminator constant is equal to $K_\phi 2\pi \tau_d$, where K_ϕ is the phase detector constant and τ_d is the delay provided by the coaxial line.

Because the sensitivity of the system depends on both K_ϕ and τ_d we want to maximize both. K_ϕ is dependent on the signal level out of the delay line, which in turn depends on the length of coaxial line while attenuation is proportional to length for a given frequency. Thus we can only maximize the total function.

Sensitivity Factor Provided by the Coaxial Delay Line

The sensitivity factor provided by the coaxial delay line increases directly proportional to the coaxial line length. For this reason the sensitivity can be expressed as

$$S\tau_d = LX \quad [C.1]$$

where L is the length of the coaxial line and X represents the sensitivity per unit length. $S\tau_d$ represents the sensitivity factor provided by the delay line.

Phase Detector Sensitivity Factor

As developed in Appendix B, the phase detector constant K_ϕ equals $K_L V_R$ where K_L is the mixer efficiency and V_R is the signal level into the R port of the phase detector. V_R depends on the input signal power and the attenuation of the delay line. Attenuation of a coaxial delay line increases linearly with length when attenuation is expressed in logarithmic terms [dB].

$$\text{Attenuation [dB]} = 10 \log \frac{P_{out}}{P_{in}} = LZ \quad [C.2]$$

Again L represents the length of the delay line and, Z represents a constant of attenuation [dB] per unit length. P_{out} and P_{in} refer to the signal power into and out of the delay line. Solving for the voltage out of the coaxial delay line gives the following.

$$10 \log \frac{P_{out}}{P_{in}} = 10 \log \frac{V_{out}^2}{V_{in}^2} = LZ \text{ [dB]} \quad [C.3]$$

$$V_{out} = V_{in} 10^{-LZ/20} \quad [C.4]$$

with the negative sign on the exponent because V_{out} is less than V_{in} .

The voltage out of the delay line (V_{out}) enters the R port of the phase detector V_R , so K_ϕ becomes

$$K_\phi = K_L K_R = K_L V_{in} (10)^{-LZ/20} \quad [C.5]$$

Thus the sensitivity factor provided by the phase detector S_{K_ϕ} is

$$S_{K_\phi} = K_L V_{in} (10)^{-LZ/20} \quad [C.6]$$

The system sensitivity is a product of the delay line sensitivity factor $S\tau_d$, and the phase detector sensitivity factor S_{K_ϕ} .

$$S = S_{\tau_d} S_{K_\phi}$$

$$S = K_L V_{in} L X(10)^{-LZ/20}$$

Taking the derivative of this equation with respect to length L and setting the result equal to zero allows the maximum to be found.

$$S = K_L V_{in} L X(10)^{-LZ/20} \quad [C.7]$$

$$\frac{dS}{dL} = [1 - (LZ/20) \ln 10] * [K_L V_{in} X(10)^{-LZ/20}] \quad [C.8]$$

Setting equal to zero and rearranging terms

$$0 = [1 - (LZ/20) \ln 10] * [K_L V_{in} X(10)^{-LZ/20}]$$

$$0 = [1 - (LZ/20) \ln 10]$$

$$1 = (LZ/20) \ln 10$$

$$LZ = \frac{20}{\ln 10} \quad [C.9]$$

Finally the maximum sensitivity occurs at an attenuation, LZ, of

$$LZ = 8.7 \text{ dB.}$$

The maximum is not specified in length, but in terms of attenuation. This is important to note because the attenuation of a given coaxial line will change depending on the carrier frequency passing through it. Figure C.1 shows a plot of sensitivity versus attenuation and indicates the maximum sensitivity at an attenuation of 8.7 dB.

Figure C.1. System sensitivity vs. delay line attenuation.

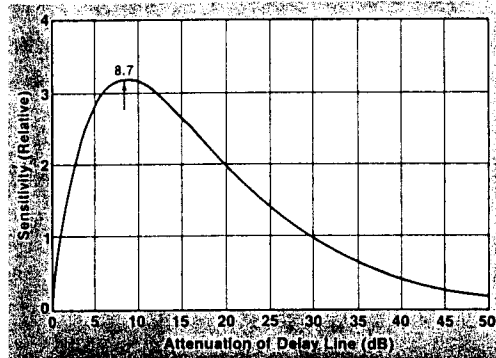

The maximum determined above assumed that the phase detector sensitivity was being affected by the delay line attenuation. However, as long as the phase detector is in compression, K_ϕ is constant and the equation developed above does not hold true. Any signal power above the phase detector compression point can be attenuated in the delay line (increased length for increased sensitivity). Thus as soon as the phase detector comes out of compression, the 8.7 dB trade off applies.

The phase detector compression point for the HP 11729C is typically +3.5 dBm. This means for optimum sensitivity the signal level out of the delay line should be approximately -5 dBm (3.5 dBm - 8.7 dB = -5.2 dBm).

D Calibration and the Discriminator Constant (K_d)

The discriminator constant (K_d) is the constant of proportionality between the frequency fluctuations of a source and the voltage fluctuations out of the frequency discriminator. As shown in Appendix A, K_d is equal to $\Delta V / \Delta f$ with units of volts per hertz (V/Hz).

An easy way to determine the discriminator constant is to measure the system response P_{cal} to a known signal ΔSB_{cal} (see Figure D.1). From modulation theory for small modulation index ($m < 0.2 \text{ rad}$)

$$\frac{P_{ssb}}{P_{carrier}} = \frac{m^2}{4} = \frac{1}{4} \frac{(\Delta f_{calpk})^2}{(f_{mcal})^2} = \Delta SB_{cal} \quad [D.1]$$

Where Δf_{calpk} is the peak deviation and f_{mcal} is the FM rate of the calibration signal.

By rearranging equation D.1

$$\begin{aligned} (\Delta f_{calpk})^2 &= 4 f_{mcal}^2 10^{\frac{\Delta SB_{cal} [\text{dB}]}{10}} \\ (\Delta f_{calrms})^2 &= 2 f_{mcal}^2 10^{\frac{\Delta SB_{cal} [\text{dB}]}{10}} \end{aligned} \quad [D.2]$$

By definition

$$K^2 = \frac{\Delta V_{rms}^2}{\Delta f_{rms}^2} \text{ for } f_m < \frac{1}{2\tau_d} \quad [D.3]$$

Substitution of equation D.2 into D.3 yields

$$K^2_d = \frac{\Delta V_{rms}^2}{2 f_{mcal}^2 10^{\frac{\Delta SB_{cal} [\text{dB}]}{10}}}$$

Or in logarithmic terms

$$K_d [\text{dB}] = P_{cal} [\text{dB}] - (\Delta SB_{cal} [\text{dB}] + 20 \log f_{mcal} + 3 [\text{dB}])$$

where P_{cal} equals the measured system response (ΔV_{rms}^2) in dB.

Figure D.1. Determining the discriminator constant by measuring system response.

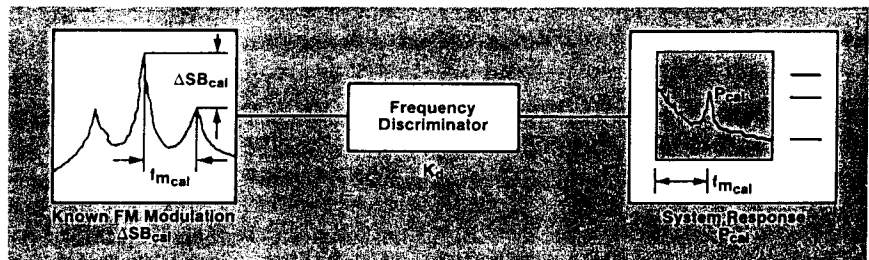

E The Importance of Quadrature

As shown in Figure E.1, phase quadrature is the point of maximum phase sensitivity and the region of most linear operation. Any deviation, ($\Delta\phi$), from quadrature results in a measurement error given by

$$\mathcal{L}_e = \text{error (dB)} = 20 \log [\cos (\text{magnitude of the phase deviation from quadrature})]$$

where error is defined as $\mathcal{L}(f_m)$ measured $- \mathcal{L}(f_m)$ at $\Delta\phi = 0$ in dB. Notice that the error in dB is always negative, since $\mathcal{L}(f_m)$ measured is always $\leq \mathcal{L}(f_m)$ at $\Delta\phi = 0$.

The error contribution is very small for small deviations around quadrature, as shown in the table below.

Offset from quadrature	Error
1°	-0.001 dB
3°	-0.01 dB
10°	-0.13 dB

Even though the error for small deviation around quadrature is small, in a user-designed noise measurement system, this deviation from quadrature would have to be monitored. The HP 11729C's quadrature maintenance section provides the monitoring capability.

Figure E.1. Typical double-balanced phase detector characteristic.

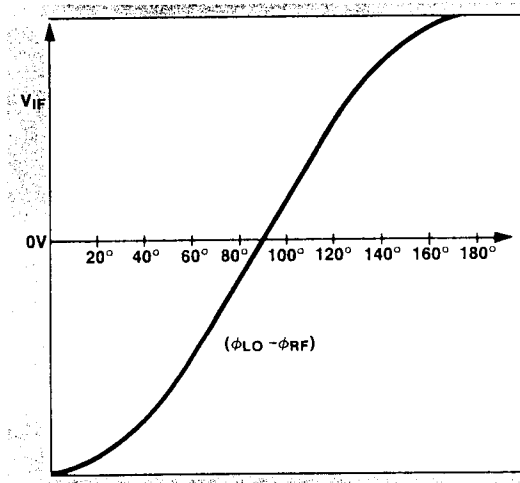

F HP 11729C HP-IB Programming Codes

The Hewlett-Packard Interface Bus (HP-IB) is a general purpose digital interface which simplifies the design and integration of instruments and computers into systems. The following commands can be used to control the HP 11729C by computer.

AM	Selects AM Noise Measurement Mode
PH	Selects Phase Noise Measurement Mode
PU	Selects Pulsed Carrier Measurement Mode
FT1	Selects first filter band (10 to 1280 MHz)
FT2	Selects second filter band (1.28 to 3.2 GHz)
FT3	Selects third filter band (3.2 to 5.76 GHz)
FT4	Selects fourth filter band (5.76 to 8.32 GHz)
FT5	Selects fifth filter band (8.32 to 10.88 GHz)
FT6	Selects sixth filter band (10.88 to 13.44 GHz)
FT7	Selects seventh filter band (13.44 to 16 GHz)
FT8	Selects eighth filter band (16 to 18.56 GHz)
LK1	Selects Lock Bandwidth Factor of 1
LK2	Selects Lock Bandwidth Factor of 10
LK3	Selects Lock Bandwidth Factor of 100
LK4	Selects Lock Bandwidth Factor of 1k
LK5	Selects Lock Bandwidth Factor of 10k
CA1	Enables Capture
CA0	Disables Capture
LP	Learn Front Panel
RO	Read Option List
RM	Read RSQ
@	Accept RSQ
CS	Clear Status Byte
?ID	Read Instrument Type

G References

References

Hewlett-Packard Application Notes

AN 150-4 Spectrum Analysis . . . Noise Measurements (HP Lit #5952-1147)

AN 150-8 Spectrum Analysis . . . Accuracy Improvement (HP Lit #5952-9210)

Hewlett-Packard Product Notes

PN 11729B-1 Phase Noise Characterization of Microwave Oscillators Phase
Detector Method (HP Lit #5952-8286)

Other References

Scherer, D. (HP) "The 'Art' of Phase Noise Measurements", HP RF Microwave
Measurement Symposium, October, 1984.

"Phase Noise" RF & Microwave Phase Noise Measurement Seminar, Hewlett-
Packard.