

# CASSINI ATE SYSTEM

---

## REFERENCE GUIDE



# ABOUT THIS MANUAL

---

**This section provides information about:**

- **How this manual is organized**
- **Revision history**
- **The notational conventions used in this manual**
- **How to interpret Notes, Cautions, and Warnings**

*This book is dedicated to the engineers, technicians, and operators who have devoted themselves to the noble profession of semiconductor test. Often overlooked and seldom recognized, those in our field make possible the dreams and aspirations of countless others. We are the last stop in the arduous proving grounds of tomorrow's technology. We are the driving force that tests the boundary of what is possible. We are the silent reassurance that the next generation of technology will deliver on its promise of performance, innovation, and ingenuity. It is because we have devoted our life's work to the pursuit of quality, precision, accuracy, and reliability that greater technological achievements are possible. Though our tireless contributions may never be seen, they are imbued in every chip we test.*

# REVISION HISTORY

## Version 1.4 — November 2014

Initial release of the Reference Guide.

## Version 2 — March 2016

About This Manual | Section 2 - Using This Book

- Descriptions for scrolling view feature and font size adjustment features were added for iPads running iOS 9.0 or later.

Chapter 2 - Graphical Programming | Section 1 - Introduction

- General descriptions and user information added for the graphical programming environment: Synapse - Test Program Optimizer, Conditional Statements, Measure and Measure Sequence groups, Lock Step groups, Pre Measure and Post Measure groups, and Combined groups.

Chapter 2 - Graphical Programming | Section 11 - RI8574: System Controller (EPC)

- Edit button descriptions were added for button and blocks found in the Data Saves, Flow Control, State, Input Output State, and General Calculation panels. These include **Calc** buttons as well as program flow control, conditional statements, user-defined flags, and compiler directive buttons.

Chapter 2 - Graphical Programming | Section 15 - RI8581: 100kHz to 20GHz Receiver & Section 16 - RI8587: 100kHz to 20GHz DSP Receiver

- Edit button block diagrams updated to include the LO outputs (LO Out A, LO Out B, LO Out C) and IF inputs (IF In A, IF In B, IF In C) button controls via the source **Input** button.
- Edit button description for the source **Input** button updated to include description for controlling the tandem switch routing of the LO outputs (LO Out A, LO Out B, LO Out C) and IF inputs (IF In A, IF In B, IF In C).

Chapter 2 - Graphical Programming | Section 8 - RI8564: 71GHz to 83GHz TestSet

- Updated instrument description and block diagram to the latest version to reflect new performance specifications.

Chapter 5 - Diagnostics

- Chapter completely updated with an introduction to diagnostics on the Cassini ATE, including factory recommended practices for instrument validation and test system release procedures.



- Provide details and description of the diagnostic software UI: Diagnostic Executive including menu options, user controls, and data export.
- The Diagnostic Kit and associated diagnostic hardware are described with included examples.
- Updated procedures for running diagnostics, self tests, and supplemental diagnostics for the Cassini ATE system.

#### Chapter 7 - Troubleshooting

- Export Simulation section added. Section describes how to create a test setup capture of the Cassini test software environment for RI support assistance.
- Minor updates and corrections.

#### Chapter 8 - Appendix | Section 9 - RI8564: 71GHz to 83GHz TestSet

- Updated instrument description, block diagram, and performance specifications.

#### Chapter 8 - Appendix | Section 13 - RI8574: System Controller

- Minor corrections throughout chapter.
- Additional description and information about the RIFL Master topology were added.

#### **Version 2.1** — August 2016

##### Chapter 1 - System Information | Section 5 - Installation

- Minor updates to clarify installation procedure.

##### Chapter 1 - System Information | Section 9 - Handler and Prober Interfacing

- Procedure added including steps to attach grounding cable and Handler/Prober control pod.

##### Chapter 3 - Care & Maintenance | Section 6 - RF Connector Care

- Steps and recommendations for SMA connector tightening.

##### Chapter 5 - Diagnostics

- Update to procedure for selecting an alternate diagnostic list.

##### Chapter 8 - Appendix

- Minor corrections throughout chapter.

#### **Version 2.2** — October 2016

##### Chapter 8 - Appendix

- Minor correction to Ri8535: Universal Digital

**Version 2.3** — December 2017

## Chapter 1 - System Information

## Section 11: Guru

- New section with content moved from Section 10: Software Environment and Tools
- Added information on user access control.

## Section 12: Device Connection Editor

- New section covering the UI and user features.

## Section 13: Device Control Editor

- New section covering the UI and user features.

## Chapter 2 - Graphical Programming

## Section 1 - Introduction

- Added information about symbol tables, setting buttons from symbols, and setting buttons from local variables.

## Section 4 - RI8535: Universal Digital

- Updates and corrections to edit button descriptions

## Section 6 - RI8546: Device Power/Measure

- Minor corrections to StaticDigital edit button descriptions

## Section 7 - RI8563: 4GHz - 40GHz TestSet

- Updated edit button diagram
- Updates and corrections to edit button descriptions

## Section 8 - RI8564: 71GHz - 86GHz TestSet

- Added edit button diagram for RI8564C Version

## Section 9 - RI8567: 0.01 to 12GHz TestSet

- Updated edit button block diagram and updates/corrections to edit button descriptions

## Section 17 - RI8589: High Power Supply/Pulser

- New instrument added

## Section 19 - RI8595: 700MHz to 6GHz Power Amplifier

- New instrument added

## Section 20 - RI8604: 71GHz - 86GHz TestSet

- New instrument added

## Chapter 8 - Appendix

## Section 9 - RI8564: 71GHz - 86GHz TestSet

- Added block diagram and performance specifications for RI8564C version

## Section 10 - RI8567: 0.01 to 12GHz TestSet

- Updated block diagram

## Section 19 - RI8589: High Power Supply/Pulser

- New instrument added

## Section 21 - RI8595: 700MHz to 6GHz Power Amplifier

- New instrument added

## Section 22 - RI8604: 71GHz - 86GHz TestSet

- New instrument added

**Version 2.4** — March 2018

Fix for a bug that prevented sections from being displayed in the Table of Contents on iOS devices.

**Version 2.5** — May 2018

Fixed a bug that displayed the page numbers incorrectly.

Fixed hyperlinks throughout the Reference Guide.

**Version 2.6** — April 2019

## Chapter 2 - Graphical Programming

## Section 5 - RI8545: 0.1 to 20GHz TestSet

- Updates to Pulse Width, Src 1 Seq, and Measure Mode button descriptions.

## Section 6 - RI8546: Device Power/Measure

- Updates to StaticDigital edit button descriptions for I2C communication.

## Section 17 - RI8589: High Power Supply/Pulser

- Added button descriptions for high-speed profiler available on RI8589B model
- Correction to example test plans

## Section 18 - RI8594: High Perf. Waveform Generator &amp; Measure

- Added measurement datatypes

## Section 11 - RI8574: System Controller (EPC)

- Updated button descriptions for Measure Ref, Trigger Ref, Trigger Spacing.

**Version 2.7** — December 2019

Removed sections added in Version 2.5 for a fixed bug that prevented sections from being displayed in the Table of Contents on iOS devices.

## Chapter 1 - System Information

## Section 7 - Test Instrument Modules

- Updated blind-mate interface figures and descriptions.

## Chapter 2 - Graphical Programming

## Section 17 - RI8589: High Power Supply/Pulser

- Correction to button description of Output Range: 'hi current' mode.
- Correction to button description of HV1/HV2/HV3 Current Range

## Chapter 5 - Diagnostics

- Added information about the RI8589 FetPulser-specific diagnostic hardware and procedure.

**Version 2.8** — August 2021

## Chapter 2 - Graphical Programming

## Section 3 - RI8508: RF Modulated Source

- Added Src Mode and Src Seq buttons information.

## Section 4 - RI8535: Universal Digital

- Correction to precision voltage measure range.

## Section 6 - RI8546: Device Power/Measure

- Voltage Meas Mode "HiRes" settings use a dedicated 24-bit DAC vs the "precision measure" settings.

- Additional information for serial communication with two and three wire bus emulation

## Section 9 - RI8567: 0.01 to 12GHz TestSet

- Added additional information for Mix Side button settings.

## Section 15 - RI8581: 100kHz to 20GHz Receiver

- Added additional information for Mix Side button settings.

## Section 16 - 100kHz to 20GHz DSP Receiver

- Added additional information for Mix Side button setting.

## Section 17 - RI8589: High Power Supply/Pulser

- Correction to button description of Power Enable.

# USING THIS BOOK

The Cassini Reference Guide is a collection of basic resources for using and maintaining the Cassini ATE system's software resources and hardware components. Here the user will find safety practices, system references and diagrams as well as general care, maintenance, diagnostic, calibration, and troubleshooting information. This book is an actively updated resource that will receive ongoing updates. We encourage our users to provide feedback on the experience and future content requests through [support@roos.com](mailto:support@roos.com) to help us improve and enhance this guide.

This section provides a general overview of the tools and features of both this interactive book and the iPad to help maximize the benefits of the guide.

The reference guide was designed to take full advantage of the features provided in the interactive book. Throughout the manual, the user has access to multiple types of interactive figures, integrated notes, and multimedia to provide a rich resource for understanding and using the Cassini ATE system. The following pages provide a summary of the available content, explanation of the various resources used throughout this book, and some basic instruction on how to get the most out of the eManual.

## GESTURES

The book design and layout were optimized for an iPad in both portrait and landscape modes to provide the best user experience. The following pages illustrate some common gesture conventions that will help the user interact with the books features. Most gestures are also supported by PDF readers on devices with a touch interface.

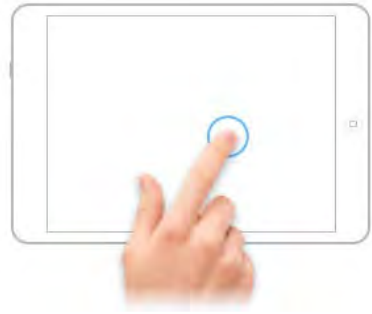


### Tap

The entire screen acts like a button. Tapping a single finger anywhere will register as a 'click.'

### TAP

A one-finger tap can be used throughout the book to enable multiple features. When a single tap is used on a figure, the image or diagram will be rendered in a full screen view. A single tap within an interactive image, review question, or multimedia window in the book will provide interaction control. A single tap on text or the background of the book will show the menu bar at the top of the screen. Two taps in quick succession over text will select the word tapped. A menu will appear above the selected text allowing the user to choose an action.

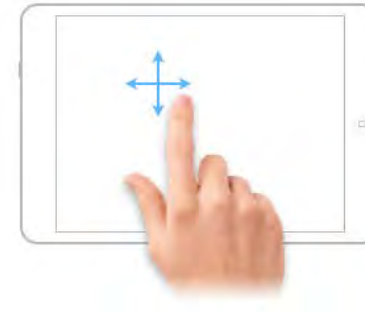


## Hold

Pressing one finger down on the screen and holding it in the same position on the screen.

## HOLD

The hold gesture is a useful shortcut for using the highlighter feature in the text areas of the book. Pressing and holding one finger over text activates a highlighter that can be used to indicate important information. Once started, simply move the finger along the text of interest to highlight the text. The borders of the selection area can be enlarged by holding and dragging the demarcation boundaries.



## Swipe

Sliding a finger or multiple fingers across the surface of the screen in a swiping motion.

## SWIPE

A finger swipe or multi-finger swipe can be used for many functions throughout the eManual. A single finger swipe is used to move from page to page, much like swiping the pages of a physical book. Swiping a single finger from right to left across the screen, will progress the book to the next page. Swiping from left to right will progress to the previous page. Within an interactive figure or illustration, a finger swipe will control the focal view on a zoomed image, progress to the next view, or can be used to manipulate a 3-dimensional object. Swiping up or down on lists will scroll the contents of the lists correspondingly.

*NOTE: For iPads running iOS 9.0 or later, setting the book to Scrolling View will display the pages of the book in one contiguous view that can be scrolled by swiping up or down on the text.*





## Pinch

Pressing the thumb and forefinger on the screen and swiping them toward or away from each other in a pinching motion.

## PINCH

The pinch gesture has multiple functions in the book. Within a chapter or section of the book, pinching the thumb and forefinger together over text or the background will exit from the current page back to the chapter view. Pinching the thumb and forefinger away from each other over an interactive figure or gallery will expand the figure to fill the entire screen. Pinching the thumb and forefinger together over a figure in full screen mode will return it to its original size. Pinching can also be used for controlling the zoom view throughout the book. Pinching the fingers away from or towards each other over the books text or background will zoom-in or zoom-out the view on the screen temporarily. Lifting one or both fingers off of the screen during the pinch will release the temporary zoom and the text and/or image will return to the original view size.



## Rotate

Placing the thumb in a fixed position on the screen and simultaneously moving the index finger around the thumb in a circular motion.

## ROTATE

The rotation gesture is used for temporarily rotating the view of the entire screen or the orientation of an interactive image. By placing one finger on the screen in a fixed position and placing another finger on the screen and then rotating around the fixed position clockwise or counterclockwise will rotate the text and images of the page as a single image correspondingly. This rotational view is temporary. Removing one or both fingers from the screen will return the page or image to its original orientation.



## MENU CONTROLS

The interactive book employs many features and controls available in the menu control. These features are illustrated in [Gallery 1](#).

*NOTE: The PDF version of this book will only show the first illustration in a gallery. A gallery supplement PDF can be made available upon request.*

For iPads running iOS 7.0:

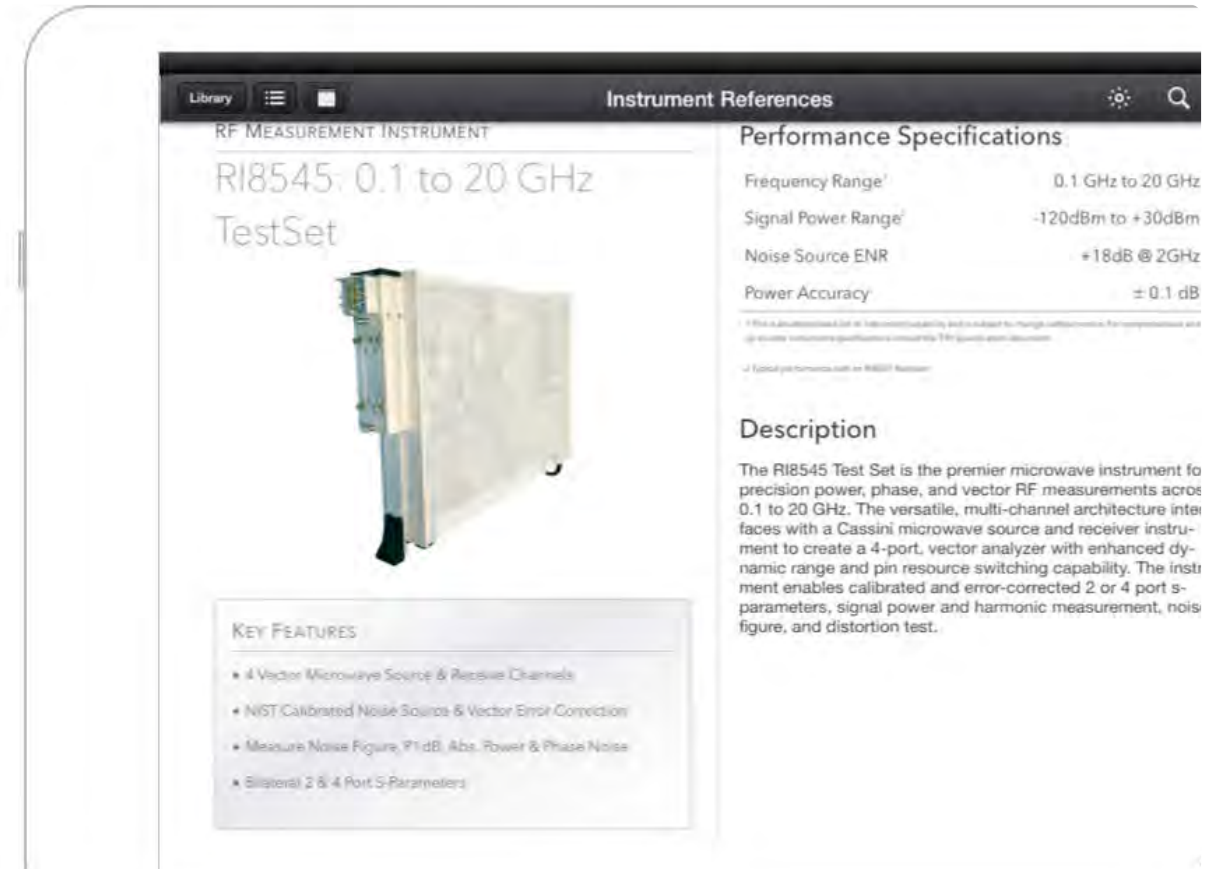
When in portrait mode, the font size can be increased or decreased to improve readability. To adjust the font size, tap on the screen when in portrait mode to bring up the menu controls. Select the font menu icon 'A' and then tap on the corresponding font button to increase or decrease the size. The book will automatically save this setting for viewing in portrait mode.

*NOTE: The font size cannot be adjusted in landscape mode.*

For iPads running iOS 9.0 or later:

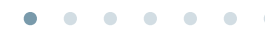
The book defaults to a portrait mode display when the iPad is held vertically or horizontal. The font size cannot be adjusted in this mode. The font size can be adjusted by switching to "Scrolling View" found under the 'A' menu icon. Once scrolling mode has been activated, the font size can be increased or decreased to improve readability. by

## GALLERY 1 INTERACTIVE BOOK MENU BAR



A single tap anywhere on the background will display the menu controls at the top of the book.

Swipe to the left to view more menu bar tools.



tapping on the corresponding font button to increase or decrease the size. The book will automatically save this setting for viewing in Scrolling View.

## NOTES

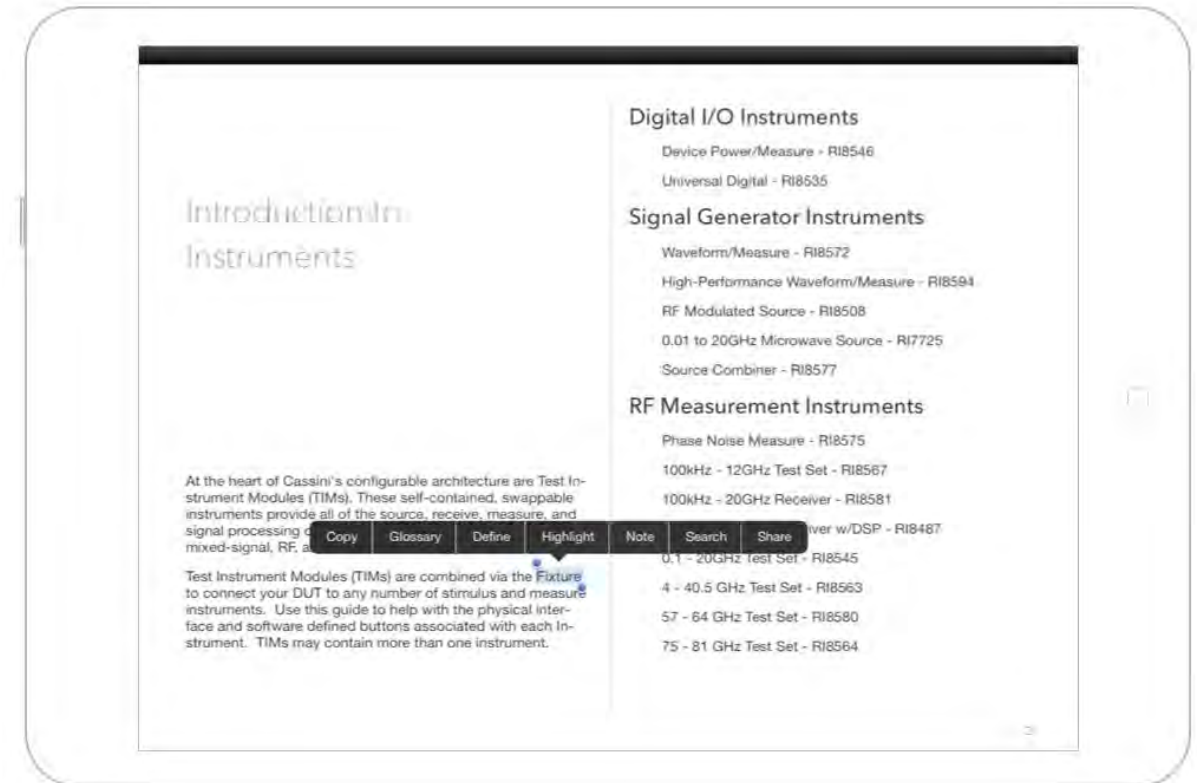
Notes allow the reader to supplement text and figures with their own notes and emphasize important texts with highlights. The notes features are illustrated in [Gallery 2](#).

**CAUTION:** Updates to the Reference Guide can affect the user's notes from version to version of the book. User notes are not deleted after an update, but the listed location of a note and hyperlink tab in the notes panel may be incorrect.

### To correct a page mismatch:

1. If the page hyperlink is incorrect, select and copy the note of the highlighted phrase or text with the incorrect page link
2. Select and search the highlighted text or phrase in the notes panel for matches in the book. (Reference [Gallery 2](#) for instructions on selecting and searching text)
3. Once the highlighted text or phrase is located in the book, tap on the highlighted text and delete the note or highlight by selecting the trash icon.
4. Create a new highlight and add a note.
5. Tap the note space to paste the previous note information into the new note.
6. Return to the notes panel and verify that the new note and page number are correct, and the old note is no longer present by verifying the creation date.

## GALLERY 2 NOTES



Double-tapping selects texts and provides menu options of: copying, searching, highlighting and more. The selection area can be expanded by holding and dragging the selection handles at each end.



---

## BOOKMARKS & RECENTLY VISITED PAGES

The bookmark feature allows the creation of a user-specified record of pages. These pages are compiled into a list that can be viewed by tapping on the bookmark icon located on the far right side of the book menu bar (see screenshot 7 of [Gallery 1](#)). Tapping on the bookmarks within the list provides quick access to content.

Beneath the list of bookmarks are buttons for accessing previously visited pages. These buttons allow the user to move forward and backward through the previously visited page of the book. This feature can be useful for more efficiently jumping between content that has been bookmarked or hyperlinked resources that are located on different pages.

---

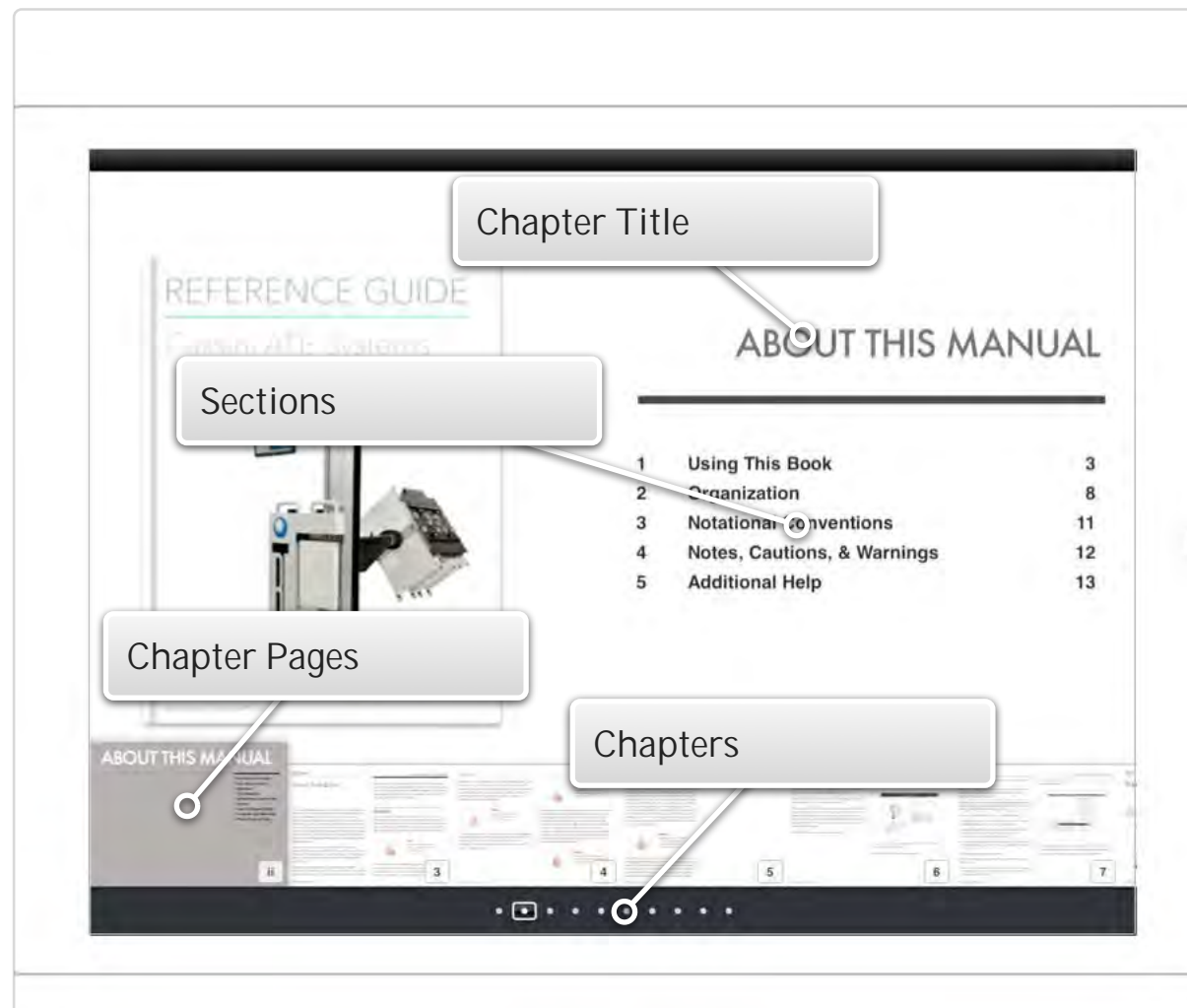
## HYPERLINKS

Hyperlinks are used throughout the text to allow quick access to referenced or associated material in the book or on the web by tapping on the hyperlink. Hyperlink text is designated by underlined blue text.

*NOTE: The recently visited pages feature, found under the bookmark tool of the menu bar, is useful for moving between hyperlinked information.*

# ORGANIZATION

## INTERACTIVE About this Manual.1 TABLE OF CONTENTS & CHAPTER NAVIGATION



The Reference Guide contains a preface, instrument references, and an appendix. The table of contents, shown in [Interactive About this Manual.1](#), displays the chapters and their associated sections in a graphical UI view. The title of the chapter is shown on the top left of the page, sections within the chapter when available are shown as a scrollable list on the right side of the page, and thumbnails of all the pages within the chapter are shown across the bottom. The reader can swipe left or right on the thumbnails to navigate to a page and tap on the thumbnail or section list to jump directly to that page or section. The number of chapters in the book are displayed along the bottom of the table of contents page as dots. Swiping left or right on the chapter title background will move from chapter to chapter.

The Instrument Reference chapter provides comprehensive information for every Test Instrument Module available on the Cassini ATE platform. The chapter provides an introductory section with general hardware information:

- TIM form factor
- Design and dimension specifications
- Input/Output types
- Docking to the test head as well as general information about software interaction tools:
- Configuration panel

- Edit panels
- Control panels

Each individual TIM is listed in subsequent sections of the chapter in ascending order of model number. The TIM sections follow a standard organization:

- Description page that includes a picture of the TIM and lists the general functionality and key features
- A functional block diagram
- Abbreviated performance specifications (comprehensive specification sheets are available upon request at: [support@roos.com](mailto:support@roos.com))
- List of instruments provided by the TIM as shown in the Tester Configuration Panel
- List and descriptions of the graphical programming buttons and blocks found in the Edit Panel for each subsystem instrument
- Descriptions of the graphical control buttons found in the Control Panel for each subsystem instrument
- Some example tests/test plans using the editor button/blocks

---

## AUDIENCE

The guide accompanies the 5-day *Cassini Basic Training Course*, covering several topics about the operation, maintenance, and general use of the Cassini Test System. This guide assumes the reader is familiar with Cassini's modular system design, graphical test plan development process, and software environment. For more information about our products and services, visit [roos.com](http://roos.com).

The Reference Guide sections are divided into the following subject areas:

- Chapter 1: System Information -- provides safety and operator guidelines, system shipping or unpacking, and site preparation information, as well as introductory material for the Cassini Infrastructure, Test Instrument Modules (TIMs), Fixtures, and Software Environment/Tools.
- Chapter 2: Graphical Programming -- provides an overview of the test design environment on Cassini. It includes an introductory chapter covering the basics of the test plan development environment, As well, the chapter includes individual sections for each of the test instrument modules, with descriptions, uses, and examples of instrument state buttons and measurement blocks.
- Chapter 3: Care & Maintenance -- provides general system and instrument maintenance cycles, safe ESD practices, and system care recommendations.



- Chapter 4: Service -- provides information about the service and support options offered for the Cassini ATE system as well as instruction for submitting support requests and TIM exchanges.
- Chapter 5: Diagnostics -- includes factory recommended practices for running diagnostics, self tests, and supplemental diagnostics for the Cassini ATE system to validate instrument and test system operation and release procedures. A detailed description of the diagnostic software UI (the Diagnostic Executive) is included along with menu options, user controls, and data export processes. The Diagnostic Kit and associated diagnostic hardware are described with included examples.
- Chapter 6: Calibration -- includes general practice calibration procedures as well as information on the associated hardware and software.
- Chapter 7: Troubleshooting -- provides software and hardware tips, tricks, and techniques for troubleshooting various parts of the Cassini's DC, digital, and RF instrumentation.
- Appendix -- contains reference material for the infrastructure (Mechanical diagrams with dimensions, specifications, etc.), all currently available Test Instrument Modules (descriptions, sub-instruments, functional block diagrams, and abbreviated specifications), user notes section, copyright information, and user agreement legal copy.

# NOTATIONAL CONVENTIONS

This manual uses the following notational conventions:

## **Control-C**

Hold down the Control key, then press the C key.

## **LMB click**

Press and release the Left Mouse Button.

## **RMB click**

Press and release the Right Mouse Button.

## **LMB hold**

Press and hold down the Left Mouse Button.

## **RMB hold**

Press and hold down the Right Mouse Button.

## **DMB click**

(Double Mouse Button) Press and release the left and right mouse button simultaneously.

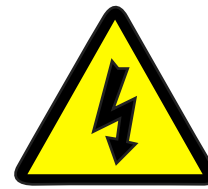
## **RI7100C or Cassini**

Refers to the family of modular ATE systems.



## **Pinch Point Hazards**

This symbol indicates pinch point hazards. Pinch points can cause serious injury including contusions, crushing of tissues and bones, and broken bones. Always keep hands, fingers, loose clothing, and persons free of areas designated as pinch points.



## **Hazardous Voltages**

This symbol indicates a voltage, either AC or DC, above 60 volts may be present. These voltages can cause bodily injury such as electrical shock or burns. A black flash signifies 60 to 999 volts. A red flash indicates the voltage exceeds 1000 volts.

# NOTES, CAUTIONS, & WARNINGS

This manual uses notes, cautions, and warnings to highlight critical information. To bring these to the reader's attention, these messages have special formats denoted below:

*NOTE: Notes provide important information, useful hints, and/or tips.*

*CAUTION: Cautions have a higher level of severity. They caution the user to not perform an action or actions that may damage the tester.*

**WARNING: Warnings have the highest severity. They warn the user to not perform some action or actions that will damage the test system and may result in personal injury.**



# ADDITIONAL HELP

Online material and reference information are available through the Roos Instruments website at [www.roos.com/support.html](http://www.roos.com/support.html). Access to the material requires a user name and password that can be obtained by registering at [roos.com/newFullUser](http://roos.com/newFullUser) or contacting support at [support@roos.com](mailto:support@roos.com).

To report hardware or software problems, suggest improvements to the test system, or request system features, contact support at [support@roos.com](mailto:support@roos.com).

For technical assistance beyond the scope of the manual and the online help system, contact Roos Instruments support at 1.408.748.8589 between 9:00 a.m. to 6:00 p.m. (U.S. Pacific Standard Time) or email support at [support@roos.com](mailto:support@roos.com).

## ROOS INSTRUMENTS CONTACT INFORMATION:

Roos Instruments  
2285 Martin Avenue  
Santa Clara, California 95050  
United States of America

Phone: +1.408.748.8589

[support@roos.com](mailto:support@roos.com)  
[www.roos.com](http://www.roos.com)

# SYSTEM INFORMATION

---



## **General information about Cassini ATE System:**

- **Operator & Safety Information**
- **Site Preparations**
- **Shipping & Packing**
- **System Installation**
- **Infrastructure**
- **Test Instrument Modules**
- **Fixtures**
- **Software Environment & Tools**

# SAFETY INFORMATION

This section provides general safety information, describes hazard warnings for personnel using or near the test system, and recommended procedures to avoid injury.

Cassini test systems are designed with an emphasis on safety and are exempt from hazards included in the [OSHA compliant safety program](#) during normal operation of the test system. If the system is used in a manner not specified in the instructions, the protection provided by the equipment may be impaired. The following safety information is based on a standard operating air temperature from 10° to 35°C (50° to 95°F) and humidity from 8% to 80%.

The following symbols are provided with their meanings along with their application to the test system.



## CE MARK

The Cassini 16 test system conforms with the essential requirements of the EMC Directive 2004/108/EC and LVD Directive 2006/95/EC, based on the following specifications applied: EU Harmonized Standards: EN 61326-1:2006, EN 61000-3-2:2006+A1:2009+A2:2009, EN 61000-3-3:2008, EN 61010-1:2001CE. Certificate available upon request. (Obtained June 16, 2011)



## PINCH POINT HAZARDS

Pinch points can cause serious injury including contusions, crushing of tissues and bones, and broken bones. Pinch point hazards for the various Cassini test system models are provided.

## CASSINI 16 (R18568)

Do not obstruct the manipulator arm channel when raising and lowering the test head. Keep it clear of objects at all times to prevent accidental damage.

---

**WARNING: Keep hands and fingers clear of the manipulator when raising and lowering the test head.**

---

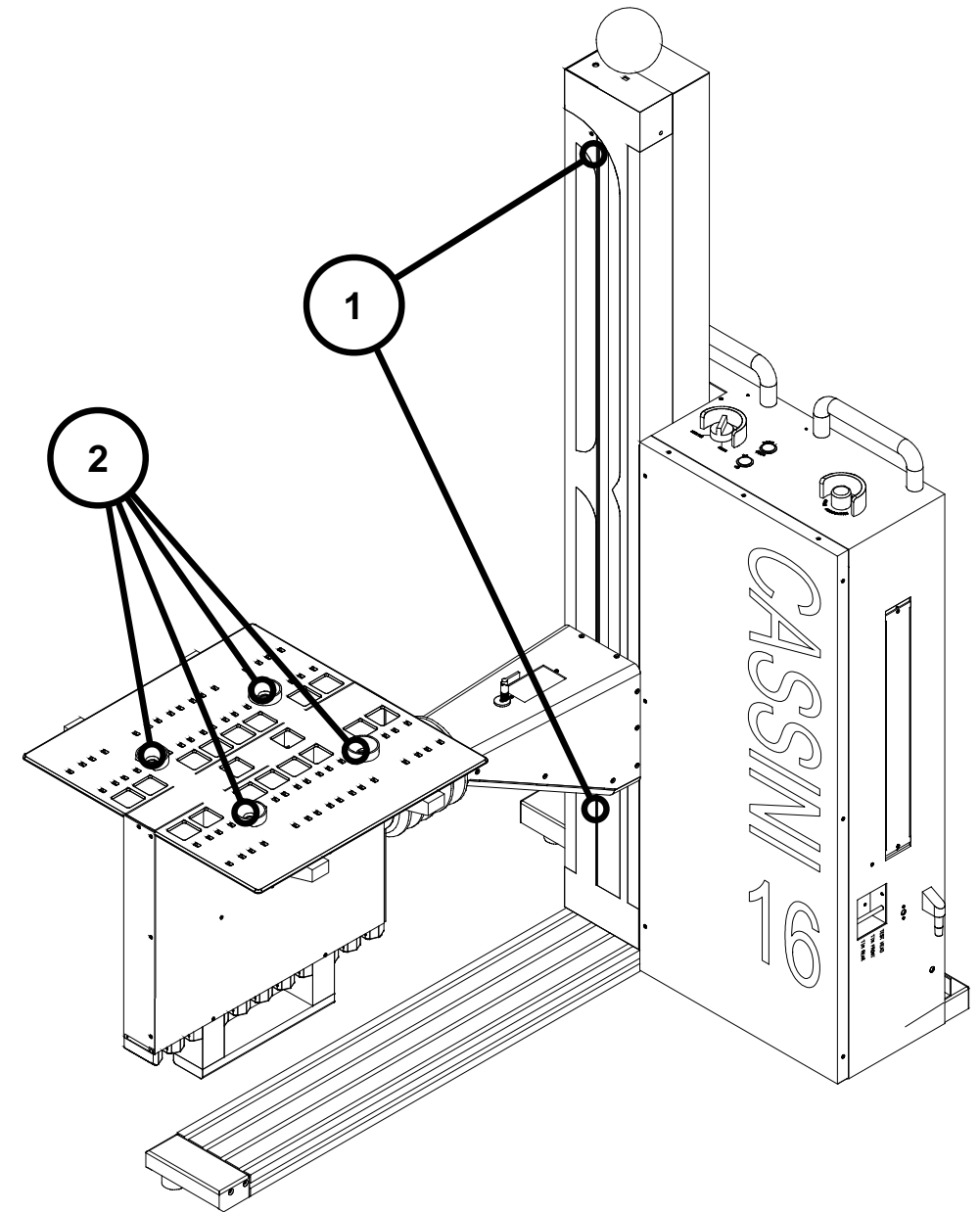
Always use caution when docking a fixture to the test head. Insure that the pneumatic fixture lock switch is set to the 'unlatched' position when a fixture is not present on the test head. Keep hands, fingers, and loose clothing clear of open slots and around the perimeter of fixture and diagnostic/calibration plates.

---

**WARNING: Keep fingers and loose clothing clear of the fixture docking ports when latching or unlatching fixtures or calibration/diagnostic plates. Never insert fingers into the docking ports. Serious injury can occur.**

---

FIGURE 1.1 CASSINI 16 PINCH POINTS

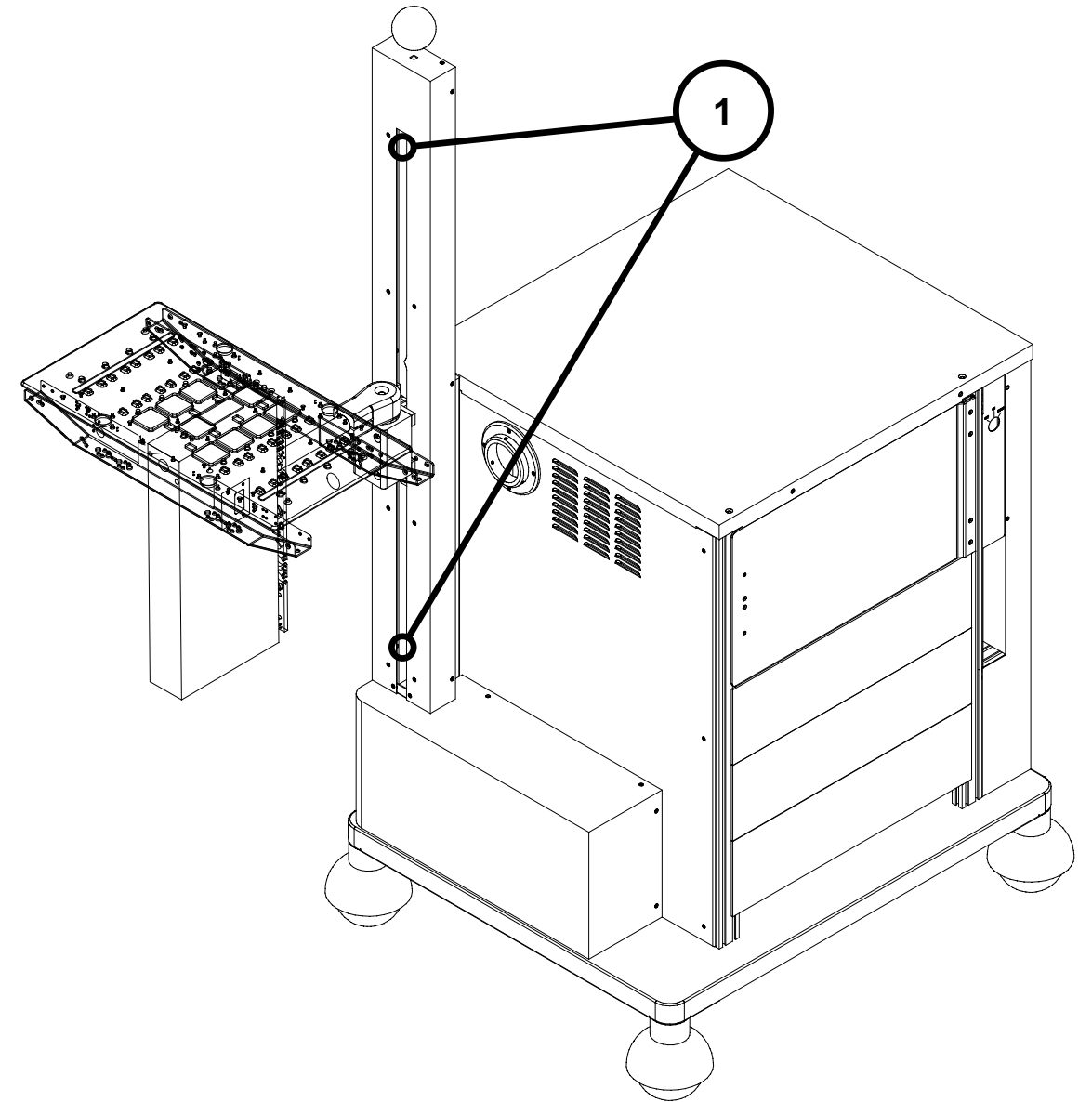


The pinch points are shown for the elevator lift's maximal positions at reference 1 and the pinch points on the test head at the fixture docking pin ports at reference 2.

## SMALL CASSINI ([RI8556](#))

Do not obstruct the manipulator arm channel when raising and lowering the test head. Keep it clear of objects at all times to prevent accidental damage.

FIGURE 1.2 SMALL CASSINI PINCH POINTS

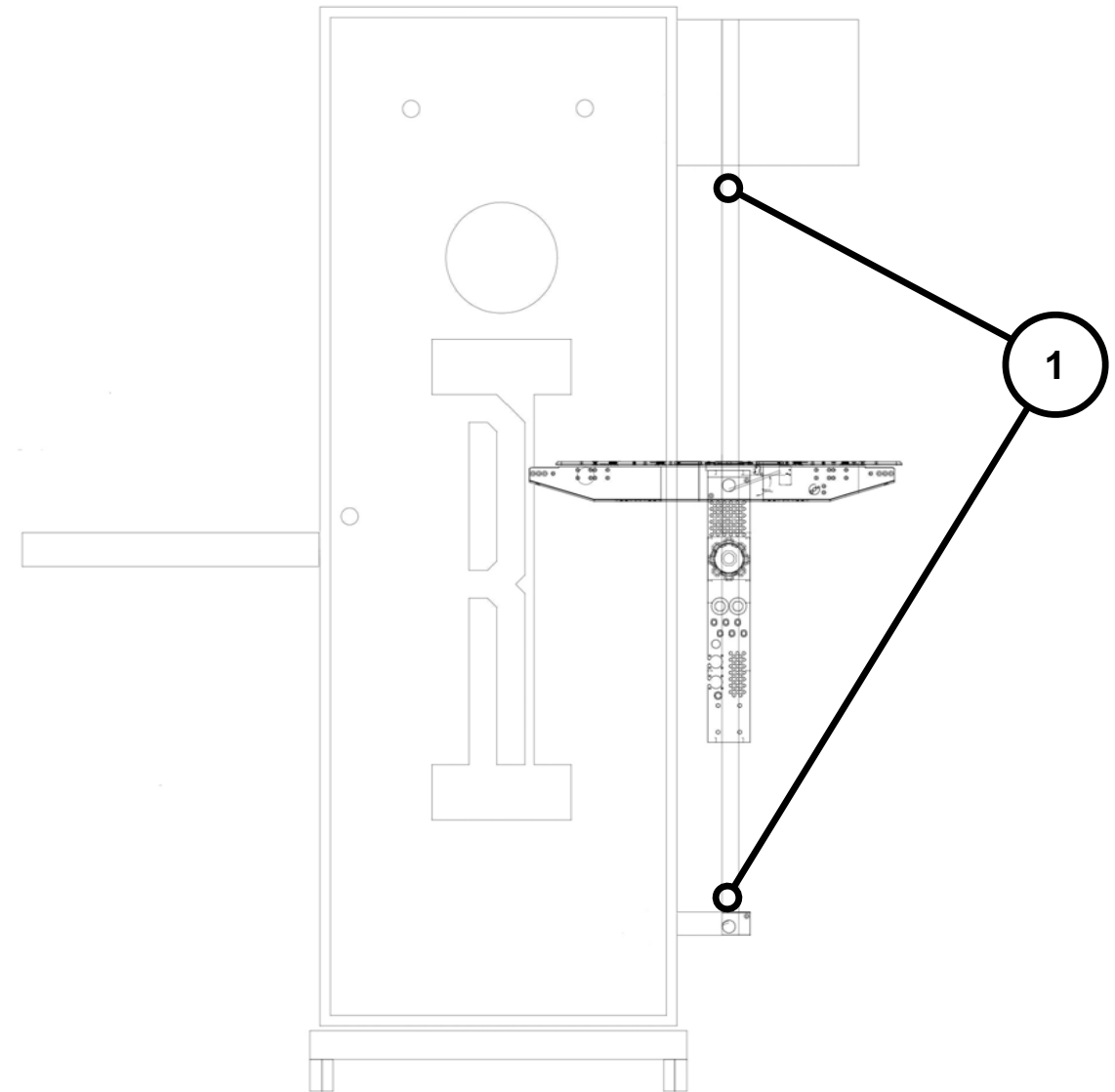


The pinch points are shown for the elevator lift's maximal positions at reference 1.

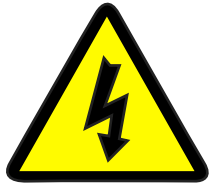
## LARGE CASSINI ([RI8557](#))

Do not obstruct the manipulator tool-balancer when raising and lowering the test head. Keep it clear of objects at all times to prevent accidental damage.

FIGURE 1.3 LARGE CASSINI PINCH POINTS



The pinch points are shown for the elevator lift's maximal positions at reference 1.



## Hazardous Voltages

Cassini test systems include 120/220 AC to DC conversion supplies to distribute 48V instrument power to the test head instrument slots and auxiliary test head connectors. Improper safety practices when working with these voltage and power levels can cause electrical shock, injury, and/or damage to the test system equipment. Caution should be exercised when accessing and servicing the test system infrastructure or test head. Always power down the test system before servicing the infrastructure or test head. The Cassini 16 and Small Cassini chassis and test head are electrically connected to earth ground when properly installed to provide safety grounding. The Large Cassini provides electrical grounding for the test head to provide safety grounding.

---

*CAUTION: Powder coated and anodized surfaces do not provide adequate grounding paths to the chassis' safety ground. Always exercise safe grounding techniques and ESD practices.*

---

---

*CAUTION: Insure common electrical grounding between the test system chassis, auxiliary rack, and handlers using the Roos Instruments supplied green grounding wire and alligator clip. Inadequate grounding can cause poor clock and or signal conditions on the communication line between the tester and 3rd party devices like handlers or probers.*

---

---

**WARNING: Depending upon system configuration options and test programs used, HAZARDOUS VOLTAGES may be present at the device interface during testing.**

---

---

**WARNING: The RI8589 High Power Supply/Pulser instrument can produce DC and pulse voltages in excess of 170V. Always power down and remove this instrument before performing any service to the instrument, fixture, device interface board, or test system.**

---

✓ **RoHS exempt**

## RoHS Exemption

Roos Instruments is exempt from RoHS standards for lead free components due to the performance characteristics of lead free components and the class of hardware ([EEE Cat. 6: Large-scale stationary industrial tools](#)).

---

**WARNING: Service and maintenance personnel should always exercise safe work practices to prevent exposure to lead-based solder when working with internal electrical components of the test system and equipment.**

---

To prevent the accidental ingestion of lead-based solder, hands should be washed with soap and water before and after working with the internals of the test system and equipment. Work areas should be kept clean and wiped with a damp paper towel to minimize the potential of residual lead in the work area.

# SAFETY PRECAUTIONS

Users should always adhere to the safety guidelines provided below:

- Read all of these instructions.
- Save this manual for later use.
- Do not use this test system unless it has been installed and maintained as specified in the appropriate Site Preparation and Installation and Maintenance manuals.
- Shut off all power before cleaning or servicing the test system. Shut down and remove test instrument modules, fixtures, and/or auxiliary equipment from the system before cleaning or servicing.
- Do not drop any part of the test system.
- Always remove fixtures or diagnostic/calibration plates from the test head when the pneumatic locks are disengaged.

---

**CAUTION: Rotating the test head with an unlatched fixture or plate can result in accidental drops and potential damage to instrumentation and fixtures.**

---

- Do not obstruct or cover the slots and openings in the system controller, test instrument modules, or test system. These openings provide cooling and ventilation for the computer and test equipment.
- Never obstruct openings of the auxiliary rack with other objects.



- Do not stack anything on top of the test system or auxiliary racks with the exception of workstation equipment: monitors, keyboard, mouse.
  - Do not cover openings at the bottom of the test system.
  - Do not place anything next to the test system that can block or impede proper airflow to or from the test system.
  - Operate the test system only from the type of power source indicated on the labels and in the manuals.
  - Keep power cords away from areas where people stand or walk. Avoid stepping on power cables.
  - Follow all warnings and instructions marked on the labels.
  - Never spill liquids of any kind on the system controller, test system, test instrument modules, fixtures or related equipment.
  - Do not attempt to service the system controller, the computer peripherals, or the test system without consulting a Roos Instrument's service or support engineer. See the maintenance manuals for servicing procedures before opening any of equipment on the test system. Repair and maintenance should be done only by qualified service or repair persons.
  - Shut off the entire test system under any of the following conditions:
    - Smoke or an odor is present.
    - Any of the infrastructure cooling fans fail to operate.
- Any kind of liquid has been spilled on any part of the system controller, computer peripheral, or test system.
  - The system controller, computer peripheral or any part of the test system has been dropped.
  - The system controller, the computer peripherals, or any part of the infrastructure has been damaged.
- Contact Roos Instruments support for service or repair under any of the following conditions:
    - The controller, computer peripherals, or test system show any change in performance.
    - Test programs does not run properly.
    - The test head or any part of the test system cannot be adjusted for a test program.

# EMERGENCY OFF (EMO) SWITCH

The emergency off (EMO) switch shown in [Figure 1.4](#), are kill switches that immediately disconnect power from the test system as quickly as possible even if this damages equipment. The EMO switch should only be used in cases of serious, unexpected, and/or dangerous situations requiring the immediate deactivation of the test system.

---

**CAUTION:** *The abrupt loss of power from an emergency shutdown can cause disk crashes, corrupted files, and lost test program edits and data.*

---

FIGURE 1.4 EMERGENCY OFF (EMO) SWITCH



The above figure shows the Emergency Off or EMO switch found on the Cassini16 and Large Cassini test systems.

# EMERGENCY SHUTDOWN PROCEDURE

The Cassini 16 and Large Cassini test systems are all equipped with readily accessible emergency off switches. These kill switches immediately disconnect power from the test system completely and as quickly as possible even if this damages equipment. The location of EMO switches for the Cassini 16 system and Large Cassini test systems are provided in [Figure 1.6](#) and [Figure 1.5](#).

*NOTE: The Small Cassini test system is not equipped with an EMO switch. The OFF/ON/START switch, shown in [Figure 1.7](#), serves as the emergency off function.*

To activate the EMO switch, depress the red button fully. The EMO switch will remain in the recessed, engaged position after it has been activated. The switch must be deactivated to restore the test system to operation. The switch is deactivated by turning the knob in a clockwise motion. This will release the button, returning it to its armed or ready position.

**CAUTION:** After an emergency shutdown, set all switches, knobs, and breaker switches on the test system, auxiliary rack, and auxiliary equipment to their 'OFF' positions. Remove all test instrument modules and fixtures from the test system.

FIGURE 1.5 LARGE CASSINI EMERGENCY OFF SWITCH

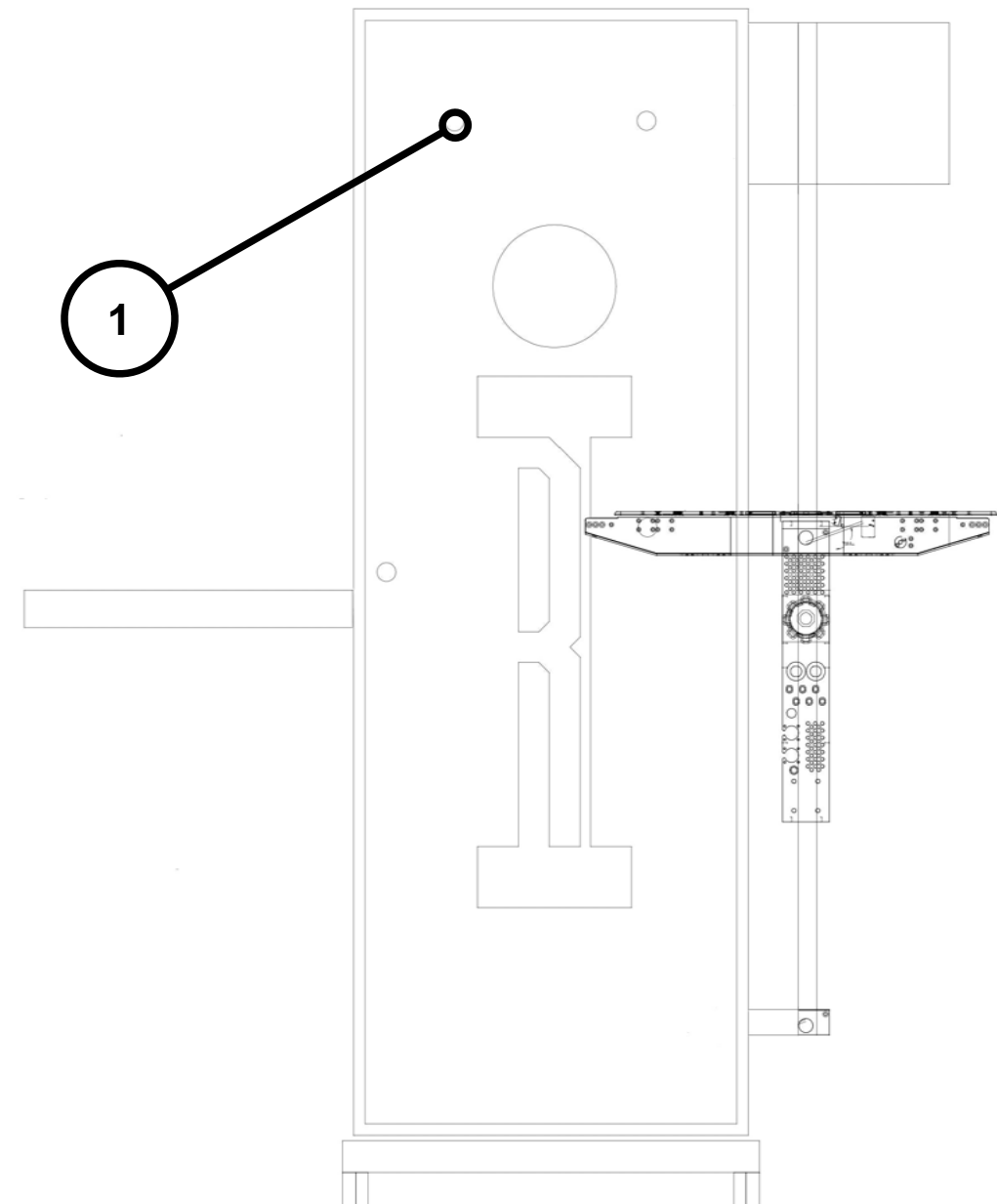


FIGURE 1.6 CASSINI 16 EMERGENCY OFF SWITCH

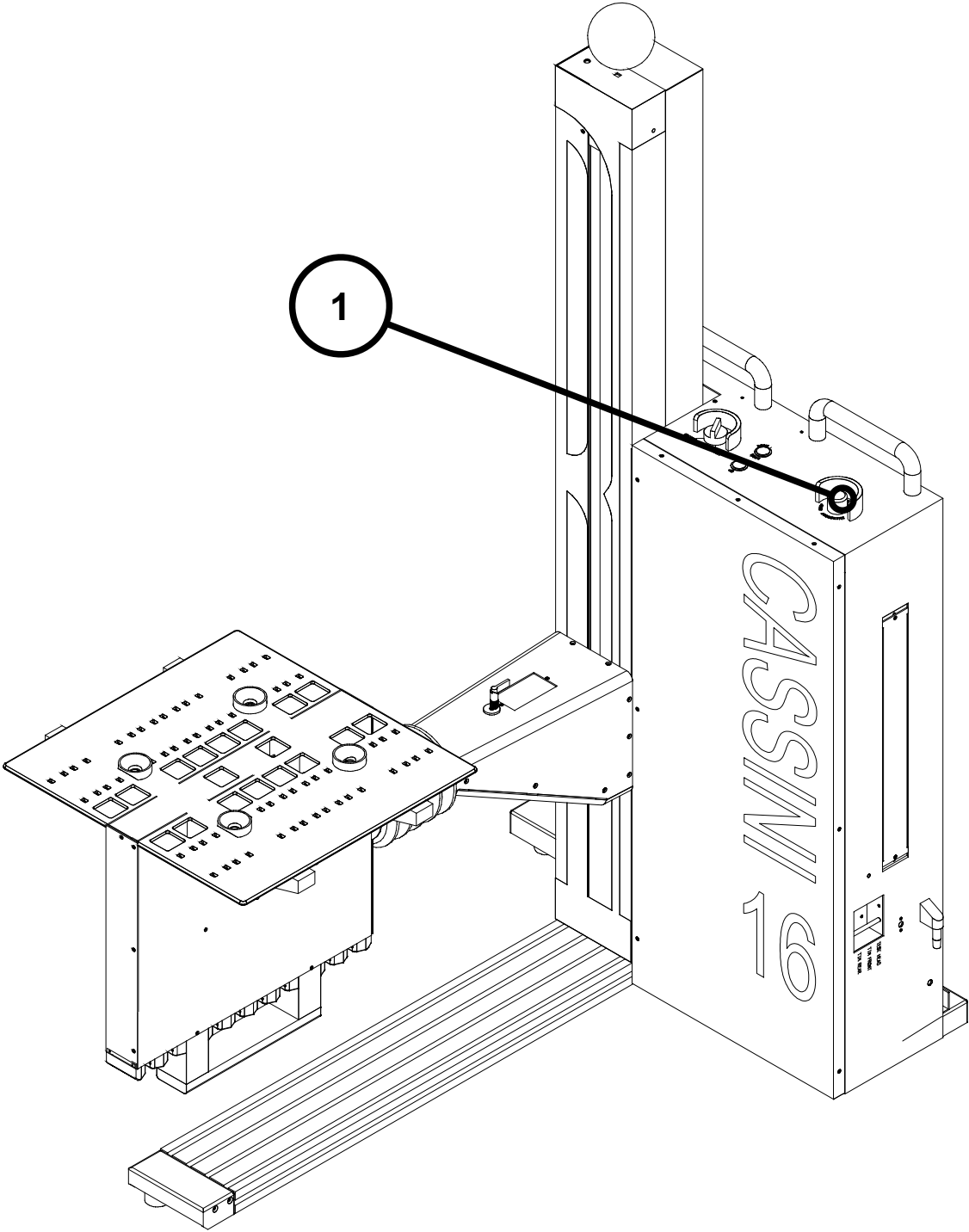
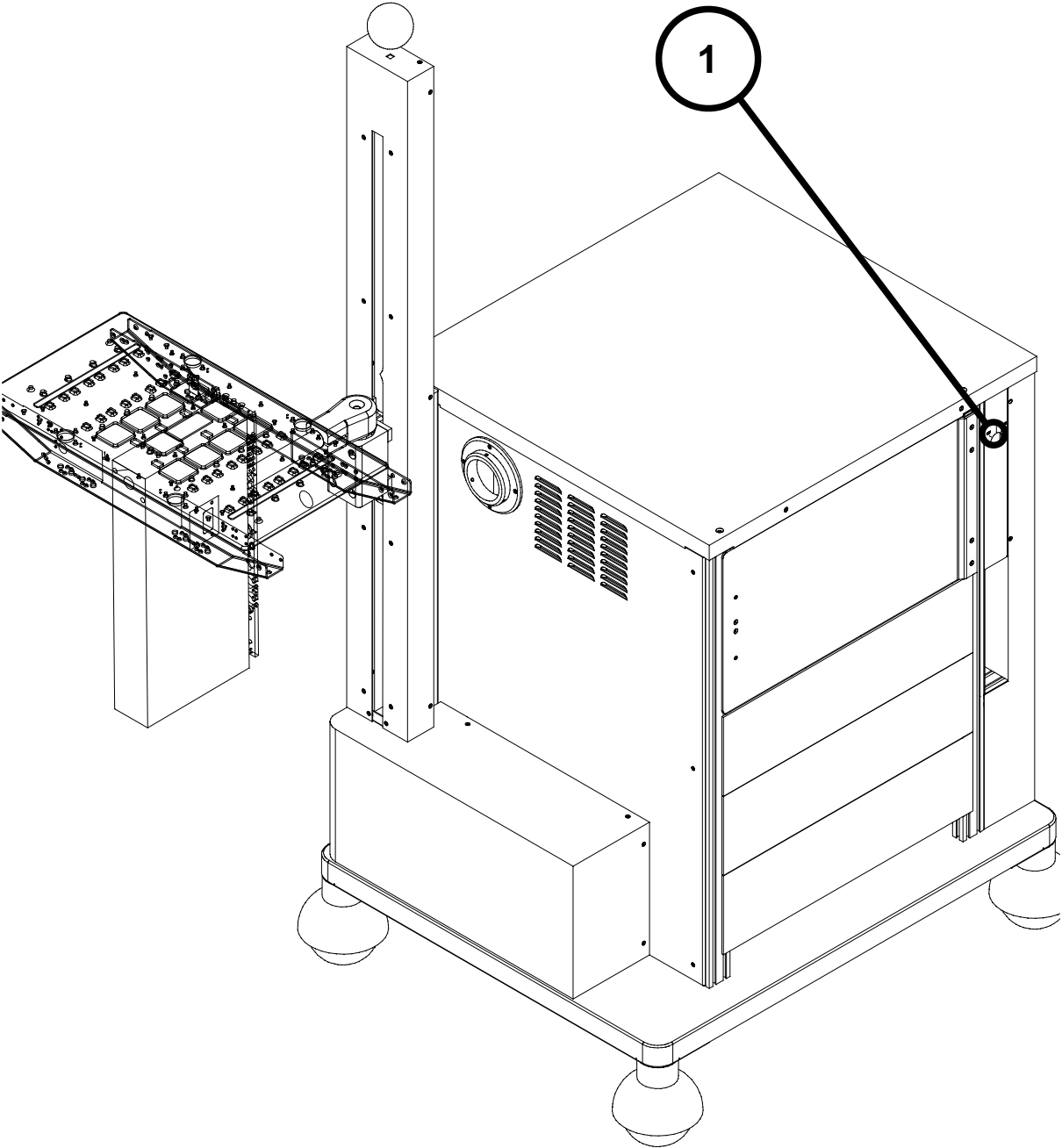


FIGURE 1.7 CASSINI 8 OFF/ON/START SWITCH



# OPERATOR INFORMATION

This section provides links to guidelines and recommended best practices for operators on the Cassini test system.

Below are hyperlinks to the associated procedures and guidelines:

- [Safety Information](#)
- [Emergency Off Switch/ Emergency Shut Down](#)
- [Start Up Procedure](#)
- [Docking to Handler or Prober](#)
- [Docking a Fixture or Diagnostic Plate](#)
- [Standard Shut Down Procedure](#)
- [Electrostatic Discharge \(ESD\) Practices](#)
- [RF Connector Care](#)

# SITE PREPARATION FOR CASSINI SYSTEMS

Cassini ATE systems can operate in a wide range of environmental conditions. Depending on the system configuration, some specifications may not apply or have individual requirements. The spatial dimensions and shipping weight of the various Cassini ATE systems and associated equipment is provided in the following section for site preparation compliance. Mechanical diagrams of the infrastructure footprints are available in the Appendix for reference.

*NOTE: All values are subject to change without notice.*

## RI8568B "CASSINI 16" INFRASTRUCTURE

### DIMENSIONS:

- Max Height: 1,847 mm (73.1 in)
- Depth: 1,208 mm (47.6 in)
- Width: 844 mm (33.2 in)

### WEIGHT:

- Max Shipping Weight: 250 Kg (550 lbs.)

### ENVIRONMENT SPECIFICATIONS:

- Operating Air Temperature: 10°C to 35°C (50°F to 95°F)  
For best calibration performance, a consistent ambient room temperature of  $\pm 5^\circ\text{C}$  is recommended.
- Humidity: 8% to 80%
- Electrical Specifications:
  - 120/220 AC (50 or 60 Hz) Single Phase
  - Plug type: IEC C19

- Power Requirements
  - Minimum: 0.15 kVA
  - Maximum: 0.75 kVA
  - Aux Rack Maximum: 1.2 kVA (300 VA per Source)
- Networking: System Controller requires a standard CAT-5 RJ45 ethernet network cable to integrate with a Guru Server.

## ELECTRICAL GROUND:

It is essential to maintain a consistent electrical ground between the handler and the Cassini test system infrastructure and auxiliary rack. This prevents Device Under Test (DUT), test system, and or handler interface damage.

- The green ground wire must be connected between the infrastructure (and auxiliary rack if necessary) and the handler's ground.

## PNEUMATIC/COMPRESSED AIR SPECIFICATIONS:

- Input Pressure Range: 65-120 PSI (regulated to 90 psi)
- System Connector Type: Quick-Disconnect US Industrial/Milton MIL-C-4109 Male (preferred), shown in [Figure 1.8](#)
- Adapters support alternative compressed air hose systems. These adapters are included with system:
- OPTION 1: Thread NPT 0.25 in Female Adapter onto air hose at facility and attach to quick disconnect on tester.
- OPTION 2: If the hose is 8 mm or 0.3125 in, use the barbed hose adapter with 0.25 in NPT male thread, shown in [Figure 1.11](#). Thread onto NPT 0.25 in Female Adapter shown in [Figure 1.9](#). Clamp the air hose to the adapter as shown in [Figure 1.10](#)

## FIXTURE:

- Height: 195.6 mm (7.7 in) - includes clearance for alignment pins
- Depth: 266.7 mm (10.5 in)
- Width - 16 slot test head: 558.8 mm (22 in)

*NOTE: Always consider the fixture height when determining the minimum clearance of the test head when working with a handler or prober.*



## HANDLER/PROBER:

- Docking and adapter plates are available based on Handler/Prober Type.
- A single GPIB/Parallel/Handler Pod is required for every handler/prober interface with a Cassini test system. Pods require factory configuration and programming. Handler/prober control logic documentation must be sent to support@roos.com at least one month prior to system installation date.
- Handler Pod Interfaces: Parallel 25 Pin Female D-Sub, Serial Female RS232, or GBIP cable.

## WORKSTATION:

- An auxiliary rack is required for monitor, keyboard and mouse workspaces.
- Workspace must be located adjacent to the system within network cable reach of the System Controller
- The System Controller and Touch UI (RI8583A) option uses the power supply from the tester. Depending on the monitor type, it may use the AUX rack power supply or need an additional outlet.

FIGURE 1.8 QUICK DISCONNECT MIL-C-4109  
MALE



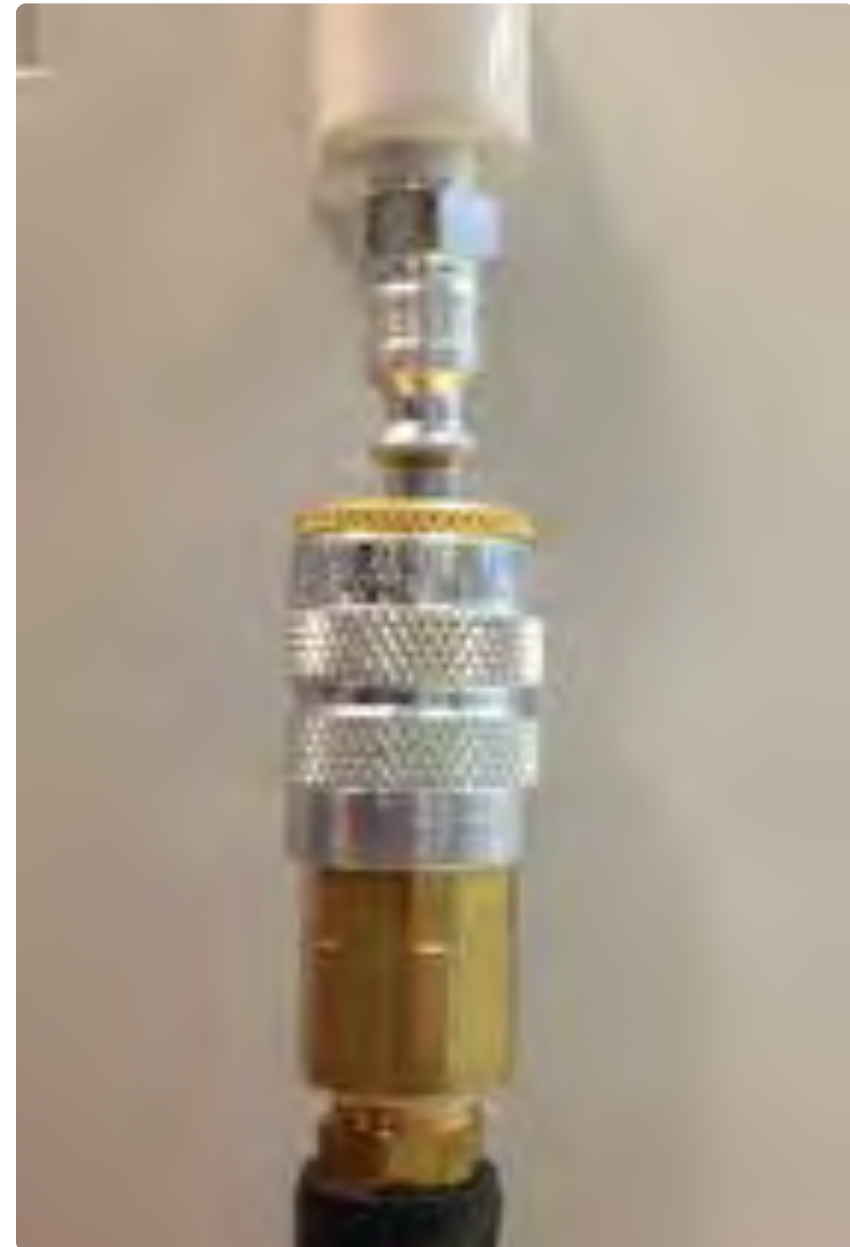
This quick connect/disconnect adapter is pre-attached to the Cassini 16 system at the factory.



FIGURE 1.9 NPT 0.25 IN FEMALE ADAPTER



FIGURE 1.10 CORRECTLY INSTALLED NPT 0.25 IN FEMALE ADAPTER



The female adapter shown above attached to an input air hose supply compressed air.

FIGURE 1.11 NPT 0.25" MALE THREAD BARBED HOSE ADAPTER AND CLAMP



---

## RI8557A "LARGE CASSINI" INFRASTRUCTURE:

### DIMENSIONS:

- Height: 1700 mm (66.9 in)
- Depth: 900 mm (35.4 in)
- Width: 600 mm (23.6 in)

### WEIGHT:

- Maximum Shipping Weight: 300 Kg (660 lbs)

### ENVIRONMENT SPECIFICATIONS:

- Operating Air Temperature: 10°C to 35°C (50°F to 95°F)  
For best calibration performance, a consistent ambient room temperature of  $\pm 5^{\circ}\text{C}$  is recommended.
- Humidity: 8% to 80%
- Electrical Specifications:
  - 115V AC  $\pm 10\%$  (or 230V  $\pm 10\%$  with option 30A)
  - System controller and monitor each require a separate 120V AC power supply outlets.

- Large Cassini Input kilovolt-amperes (kVA) approximately:
  - Minimum: 0.15 kVA
  - Maximum: 1.5 kVA
- System Controller requires a standard CAT-5 RJ45 ethernet network cable to integrate with a Guru Server.

### ELECTRICAL GROUND:

It is essential to maintain a consistent electrical ground between the handler and the Cassini test system infrastructure and auxiliary rack. This prevents Device Under Test (DUT), test system, and or handler interface damage.

- The green ground wire should be connected between the infrastructure (and auxiliary rack if necessary) and the handler's ground.



**FIXTURE:**

- Height: 195.6 mm (7.7 in) - includes clearance for alignment pins
- Depth: 266.7 mm (10.5 in)
- Width - 8 slot test head: 266.7 mm (10.5 in)

*NOTE: Always consider the fixture height when determining the minimum clearance of the test head when working with a handler or prober.*

**HANDLER/PROBER:**

- Docking options based on Handler/Prober Type.
- Only one (1) Handler Pod per handler/prober per system.  
Requires factory RI configuration and programming.  
Use Serial, Parallel or GPIB standard cable and communication interfaces. Provide detailed handler control logic documentation to support@roos.com prior to ship date.
- Handler Pod Interface Cable: Parallel 25 Pin Female D-Sub, Serial Female RS232, or GBIP cable.

**WORKSTATION:**

- A workspace cart is needed to hold monitor, keyboard, and mouse.
- Workspace must be located adjacent to the test system within network cable reach of the System Controller.
- System Controller requires a standard CAT-5 RJ45 ethernet network cable to integrate with a Guru Server.

## RI8556A "SMALL CASSINI" INFRASTRUCTURE:

### DIMENSIONS:

- Height: 1,590 mm (62.6 in)
- Depth: 733 mm (28.9 in)
- Width: 853 mm (33.6 in)

### WEIGHT:

- Maximum Shipping Weight: 250 Kg (550 lbs)

### ENVIRONMENT SPECIFICATIONS:

- Operating Air Temperature: 10°C to 35°C (50°F to 95°F)  
For best calibration performance, a consistent ambient room temperature of  $\pm 5^\circ\text{C}$  is recommended.
- Humidity: 8% to 80%
- Electrical Specifications:
  - 120/220 AC (50 or 60 Hz) Single Phase
  - Plug type: NEMA 20

- Power Requirements (kVA=KiloVolt-Amperes)
  - Minimum: 0.15 kVA
  - Maximum: 0.75 kVA
- System Controller requires a standard CAT-5 RJ45 ethernet network cable to integrate with a Guru Server.

### ELECTRICAL GROUND:

It is essential to maintain a consistent electrical ground between the handler and the Cassini test system infrastructure and auxiliary rack. This prevents Device Under Test (DUT), test system, and or handler interface damage.

- The green ground wire should be connected between the infrastructure (and auxiliary rack if necessary) and the handler's ground.

**FIXTURE:**

- Height: 195.6 mm (7.7 in) - includes clearance for alignment pins
- Depth: 266.7 mm (10.5 in)
- Width - 8 slot test head: 266.7 mm (10.5 in)

*NOTE: Always consider the fixture height when determining the minimum clearance of the test head when working with a handler or prober.*

- Handler/Prober:
  - Docking and adapter plates are available based on Handler/Prober Type.
  - A GPIB/Parallel/Handler pod is required for every handler/prober interface with a Cassini test system. Pods require factory configuration and programming. Handler/prober control logic documentation must be sent to support@roos.com at least one month prior to system installation date.
  - Handler Pod Interfaces: Parallel 25 Pin Female D-Sub, Serial Female RS232, or GBIP cable.

**WORKSTATION:**

- The workstation is integrated into the Small Cassini infrastructure.
- The System Controller and Touch UI (RI8583A) option uses the power supply from the tester.

# SHIPPING AND UNPACKING A CASSINI SYSTEM

Cassini test systems should always be packaged and shipped using the Roos Instrument's provided shipping crates. These are designed specifically for the test system with adequate sizing, anti-static material, and conformal padding to protect the test systems during transport. If this crate and shipping material are not available, contact Roos Instruments for further instructions.

*NOTE: Always store test systems and shipping crates in an ESD safe, temperature controlled environment at all times.*

*NOTE: Damage to test systems, TIMs, instruments, and/or equipment during shipping is the responsibility of the shipping party. Roos Instruments is not liability for shipping damage of equipment shipped to Roos Instruments for service, repair, or otherwise.*

## SERVICE INFORMATION

If a test system item is being returned to Roos Instruments for service, it must include a Return Merchandise Authorization (RMA) number. To obtain an RMA number, please email [support@roos.com](mailto:support@roos.com) or contact Roos Instruments at 1.408.748.8589 between the hours of 9:00 a.m. to 6:00 p.m. (U.S. Pacific Standard Time)

An RMA must be requested within 15 calendar days of the invoice date (ship date for credit card orders). NO returns of any type will be accepted without an RMA number and ALL returns must be shipped prepaid and insured via any common carrier (i.e. UPS, FedEx).

*NOTE: Tracking information is required.*

## UNPACKING CASSINI TEST SYSTEMS

Always unpack a Cassini test system on a clean, flat surface in an ESD-safe, temperature controlled environment.

Before unpacking a Cassini test system, inspect the exterior of the crate. Shipping crates may include anti-tampering metal straps around the exterior of the crate. Insure shipping documentation is attached to the exterior of the crate, and that the crate has been delivered and stored according to the orientation arrows. Inspect the exterior of the crate for signs of improper handling, storage, shipping damage, tampering, or otherwise. If any signs of visible damage, suspected mishandling or evidence of possible tampering is present, contact Roos Instruments before opening and unpacking the crate.

### TO REMOVE A CASSINI ATE SYSTEM FROM THE SHIPPING CRATE:

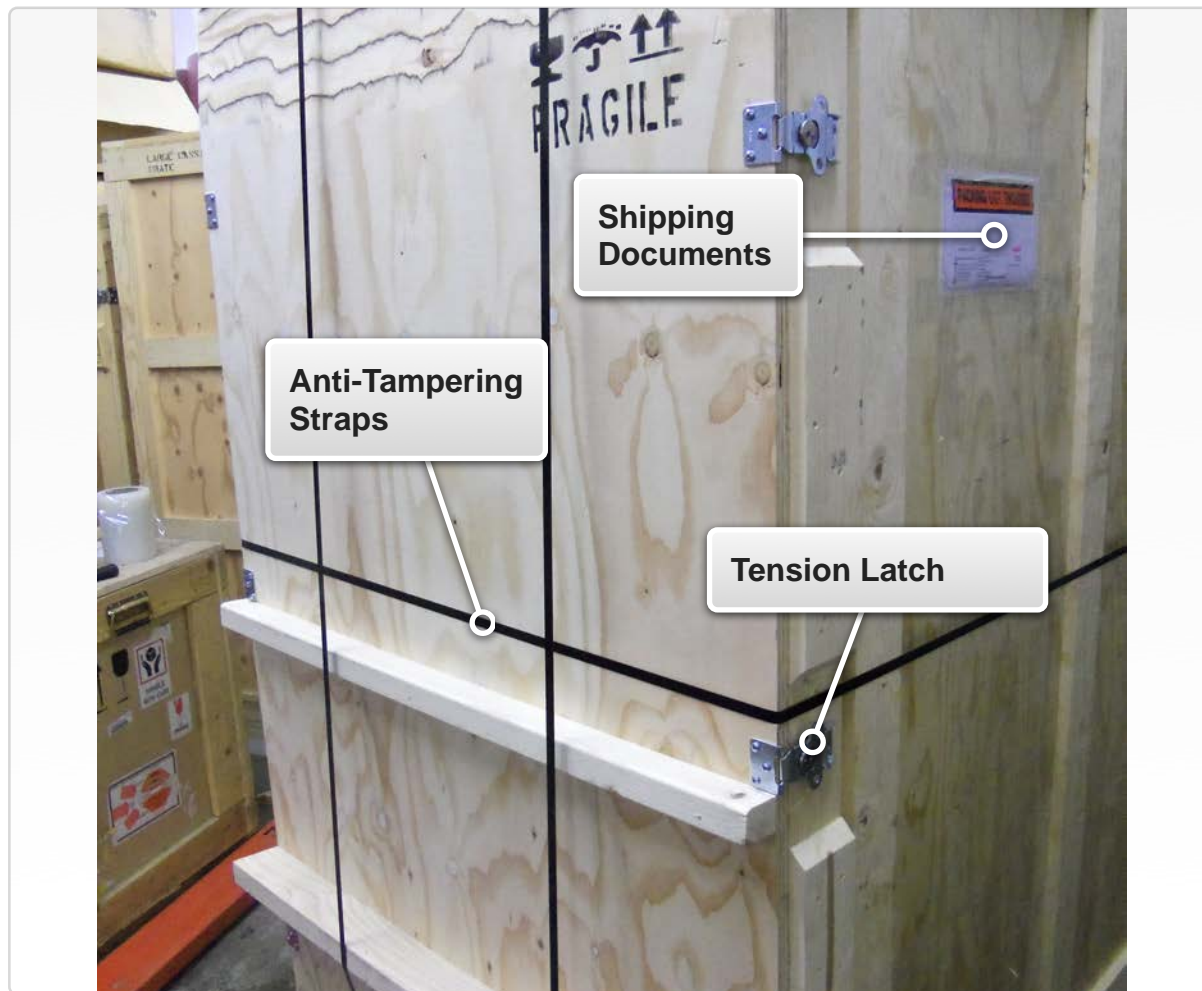
1. Insure the crate is oriented in accordance with the shipping arrows and directions on the exterior.
2. Remove and retain the shipping documentation affixed to the exterior of the crate for manifest reference and record keeping.
3. (If applicable) Remove the anti-tampering metal shipping straps from the exterior with an appropriate metal shearing tool.

4. Unlock the six tension latches located along the sides of the crate's fold down door/ramp.
5. Carefully open the fold-down crate door/ramp to access the interior.
6. Inspect the interior of the shipping crate for signs of shipping damage or improper storage during transport. Contact Roos Instruments if visible damage or moisture is present in the interior of the shipping crate.
7. The test system shipping contains other shipping containers for test instrument modules or other equipment. Remove these boxes before removing the test system infrastructure and/or auxiliary racks.
8. Loosen the wing nuts that secure the wooden cross brace in place and remove the brace as shown in [Figure 1.13](#).
9. Remove the dust cover bag.
10. Remove the test head support foam block located on the rear, right side of the ATE System.
11. Loosen the test system's stabilizer feet as shown in [Figure 1.14](#) by turning the adjustment knobs in a counter clockwise direction until they are as far above the floor as they can adjusted. This will allow the system to roll freely on the system casters.
12. Pull the Cassini ATE System out of the crate using the two large handles located along the top of the infrastructure chassis.



13. The system should roll easily down the ramp created by the open crate door.

FIGURE 1.12 UNPACKING CASSINI 16: EXTERIOR



The image above shows the test system shipping crate oriented correctly with the door/ramp facing forward.

## UNPACKING OPTIONAL SHORT AUXILIARY RACK

Once the test system is removed from the crate, the auxiliary rack can be removed.

1. Begin by removing the two foam blocks at the bottom of the rack as shown in [Figure 1.15](#).
2. Loosen the auxiliary rack's stabilizer foot by turning the knob in a counterclockwise direction until the stabilizer is as far above the floor as possible.
3. Roll the auxiliary rack out of the crate by pulling on the extended shelf so that rack can move out of the crate door and down the ramp

FIGURE 1.13 UNPACKING CASSINI 16: INTERIOR 1

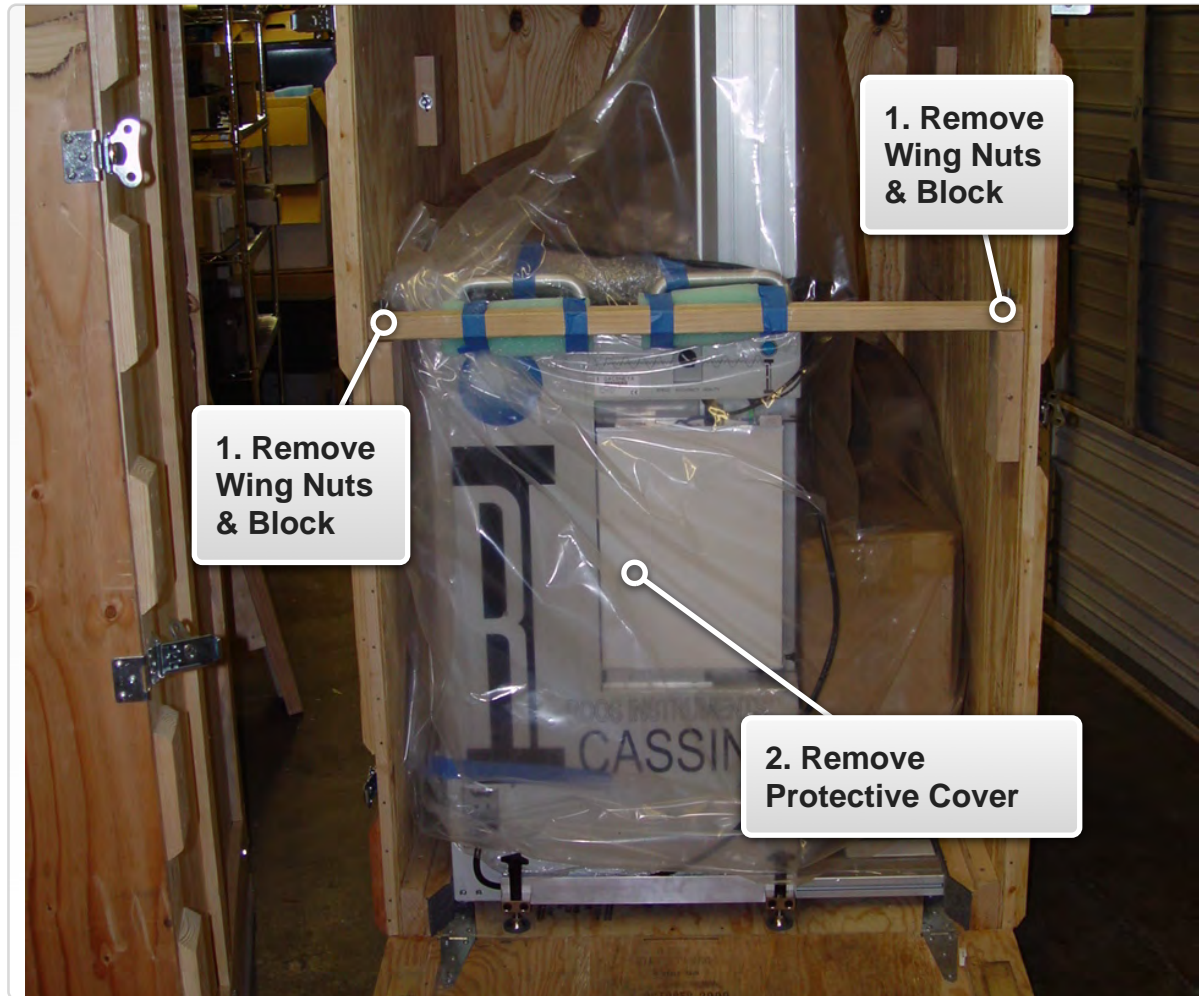


FIGURE 1.14 UNPACKING CASSINI 16: INTERIOR 2

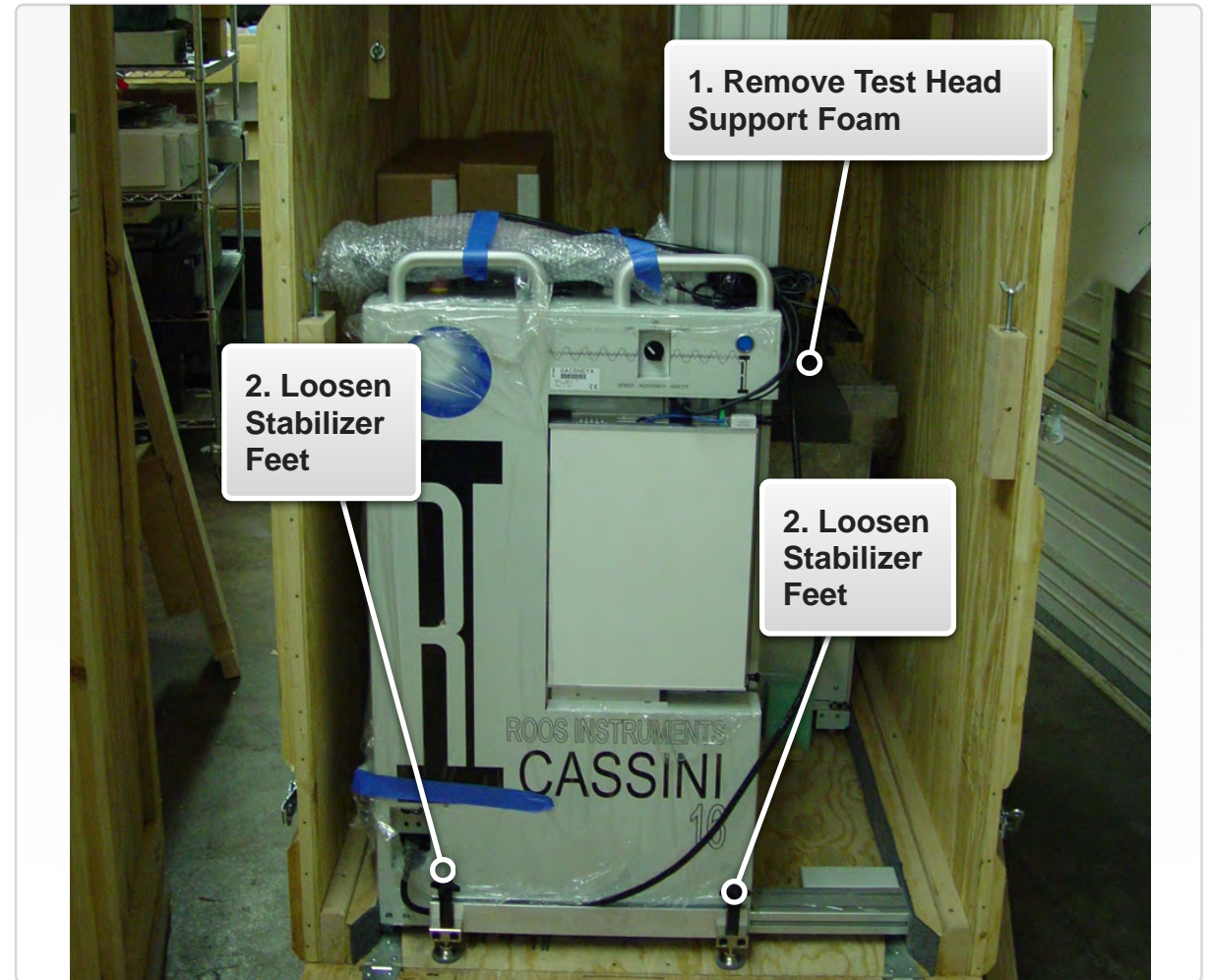
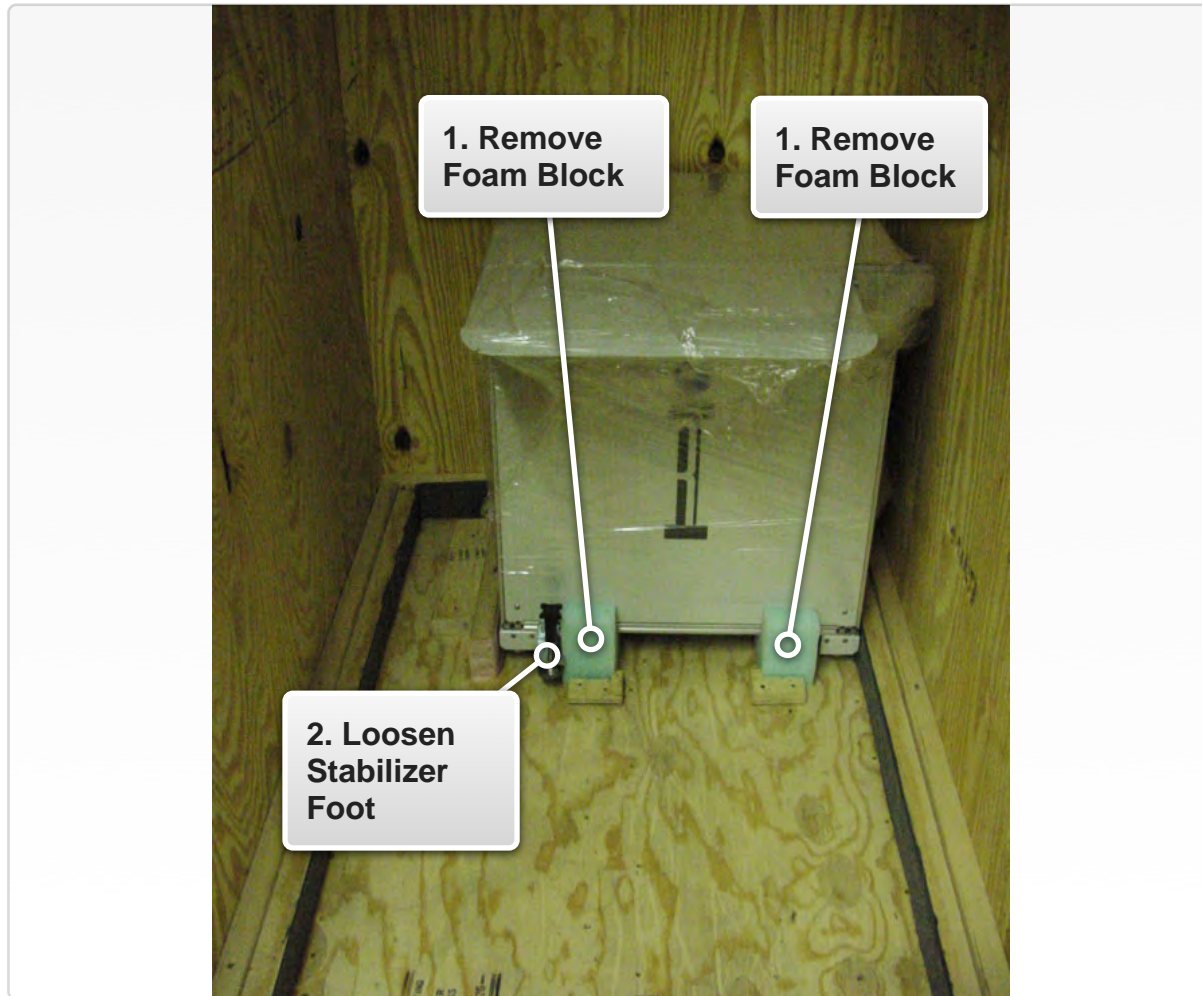




FIGURE 1.15 UNPACKING CASSINI 16: REMOVING AUXILIARY RACK



# INSTALLATION

This section provides step-by-step procedures for installing a new or re-located Cassini test system. Reference the [Site Preparation for Cassini Test Systems](#) section in the System Information chapter for test floor compliance of environmental, electrical, and equipment requirements. If the system is a new, factory provided Cassini system, adhere to the unpacking guidelines outlined in the [Shipping and Unpacking a Cassini Test System](#) section in the System Information chapter. Users should always adhere to the safety guidelines provided in the [Operator and Safety Information](#) section in the System Information chapter.

---

**WARNING: Before installing and powering up a Cassini test system, inspect the surfaces, connectors, and mechanical components of the chassis, TIMs, fixtures, and auxiliary equipment for damage. If there is any damage, do not attempt to power on the test system. Contact Roos Instruments support for recommended service, repair, and/or replacement of suspected equipment.**

---

## TO INSTALL A CASSINI 16 TEST SYSTEM:

Reference the [Cassini 16 Infrastructure Diagram](#) for component names and locations.

1. Before connecting AC power to the infrastructure, verify that both the main breaker switch and secondary breaker switches are in the OFF position.
2. Verify that the Fixture Docking Switch is in the UNLATCH position.

*NOTE: A fixture or calibration/diagnostic plate should not be docked to the test head while installing ore removing TIMs.*

3. Insure the manipulator locking pin is in the 'Maintenance Lock' position and the test head is fixed in place. This prevents the test head from moving horizontally during set up.

*NOTE: The manipulator lock should be in the 'Maintenance Position' when the tester is not attached to a handler/prober or when the system is not in use.*

4. Inspect the test head RIFL contact pads located on the underside of the test head. To access the contact pads, unlock and rotate the test head 180 degrees so that hub PCBs are visible and facing upwards.

---

**WARNING: If any damage to the test head RIFL PCB or contacts is visible, do not attach TIMs to the test head. Contact Roos Instruments support for service recommendations.**

---

5. If counterweights are to be installed, lock the test head rotation lock and install the counterweights in accordance with the included counterweight installation instructions.
6. Rotate the test head to the upright position and lock the rotation pin.
7. If the System Controller is not already installed in the infrastructure, insert the System Controller TIM. Reference the [System Controller Installation](#) instructions.
8. If the system is equipped with an auxiliary rack and auxiliary test equipment, position and lock the rack to the infrastructure chassis using the docking guides and pull lock. Reference the auxiliary rack position configurations shown in the Appendix for the [RI8568 Cassini 16 infrastructure](#). Plug in the AC line cord from the auxiliary rack's AC power distribution input.
9. Install TIMs into their appropriate slot locations. If the system is equipped with an auxiliary rack and auxiliary test equipment, also install the remote TIMs into their appropriate slot locations.

*NOTE: Reference the provided Test Head Resources or Test Head Configuration diagram for the TIM locations on a Cassini test system.*

10. Plug in the IEC C19 AC line cord to the infrastructure main AC input.

*NOTE: System supports 220 V/120 V AC.*

11. Connect the compressed air source to the test systems air input port located on the chassis adjacent to the secondary breakers. Reference the [Cassini Site Preparation](#) section for the specifications and setup of the pneumatic air system.
12. Check that the Emergency Off (EMO) switch is not engaged. Reference the EMO switch information in the [Operator & Safety Information](#) section.
13. Verify that the System Controller's ethernet port, located adjacent to the latch, is connected to a minimum standard ethernet CAT-5e RJ45 network cable connected to 10/100/1000BASE-T (Gigabit Ethernet) network switch or hub to connect the test system with a Guru Server and/or other network resources.
14. The test system can now be powered-on following the instructions provided in the [System Startup Procedures](#).

To install or setup a Small Cassini or Large Cassini test system, contact Roos Instruments at [support@roos.com](mailto:support@roos.com) for instructions and procedures.

# INFRASTRUCTURE



## TOPICS

---

[Introduction](#)

[Chassis](#)

[Test Head & Hubs](#)

[Fixture Docking System](#)

[Fixture Resources](#)

[System Controller](#)

[Installation](#)

[Start Up Procedure](#)

[Shut Down Procedure](#)

# INTRODUCTION

The Cassini test system infrastructure is designed to deliver a low-cost, high-throughput ATE solution platforms to support mixed signal, RF and microwave ICs. The three main elements to the Cassini architecture are:

- RF-based architecture designed for high accuracy, precisions, and test performance
- Modular test head that supports a high-speed data bus and precision power bus
- Small footprint, energy-efficient, system infrastructure and instruments

Cassini provides a completely configurable, modular architecture, making every part of the test system configurable. The test system design has partitioned all the measurement hardware into swappable instruments that can be inserted into universal slots on the test head to build a targeted production test solution. The modular test head design fuses a flexible microwave instrument architecture with 25 years of test system integration to deliver seamless multifunctional and multi-instrument test performance. With this versatile framework, the system can be adapted and scaled efficiently across a frequency range of DC to over 100 GHz. Instrument modularity is enabled by the Roos Instruments Fast Link(RIFL) instrument data and communication bus. It is the first open-standard bus designed specifically for production test. First introduced as a high-speed optical fiber bus,

RIFL was expanded to include precision 48V instrument power, transitioning from fiber to shielded copper. The bus is designed to support distributed compute packets across Cassini's instruments. The reduced data payloads boost overall system performance and by decoupling operation execution from the bus speed, Cassini can achieve much faster test times.

The following text provides a basic overview of the various Cassini ATE infrastructures and components.



## CHASSIS

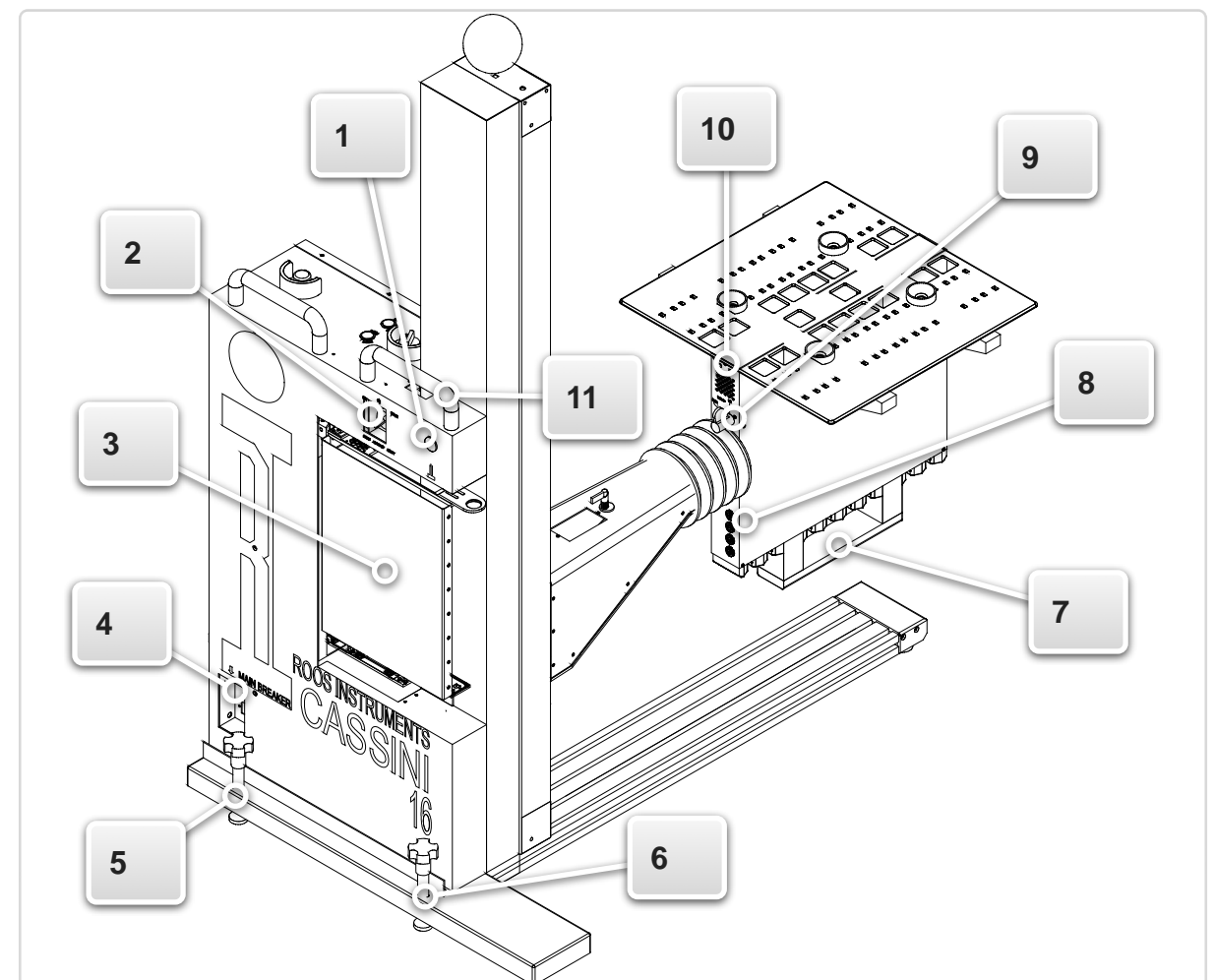
### CASSINI 16

The following numbered components reference [Figure 1.16](#).

1. **Controller Power Indicator** - blue indicator light that signifies the AC/DC switching power supply/system controller power status.
2. **OFF/ON/START Switch** - rotary switch used to power on or power off the test system controller.
3. **System Controller** - embedded user interface, multi-instrument control, and graphical test programming environment for the Cassini ATE system. Supplies the RIFL (Roos Instruments Fast Link) communication bus as well as distributing 48V instrument power and a shared 10 MHz reference clock across the instrument test head.
4. **Main Breaker** - primary test system circuit breaker that interrupts the power to the AC/DC power supply in the test system in the event of an excess current fault condition. The switch can be manually operated to de-energize the test system power.
5. **Infrastructure Stabilizer** - provides test system stabilization and leveling of the test system with the floor.

6. **Infrastructure Stabilizer** - provides test system stabilization and leveling of the test system with the floor.
7. **Test Head Counterweight** - Optional test head counterweight attachment to compensate for test instrument module loading.
8. **RIFL Hub Ports (H-Ports)** - Four RIFL (Roos Instruments Fast Link) communication ports, typically used to connect auxiliary or peripheral test equipment to the test head communication hub.

FIGURE 1.16 CASSINI 16 REAR VIEW



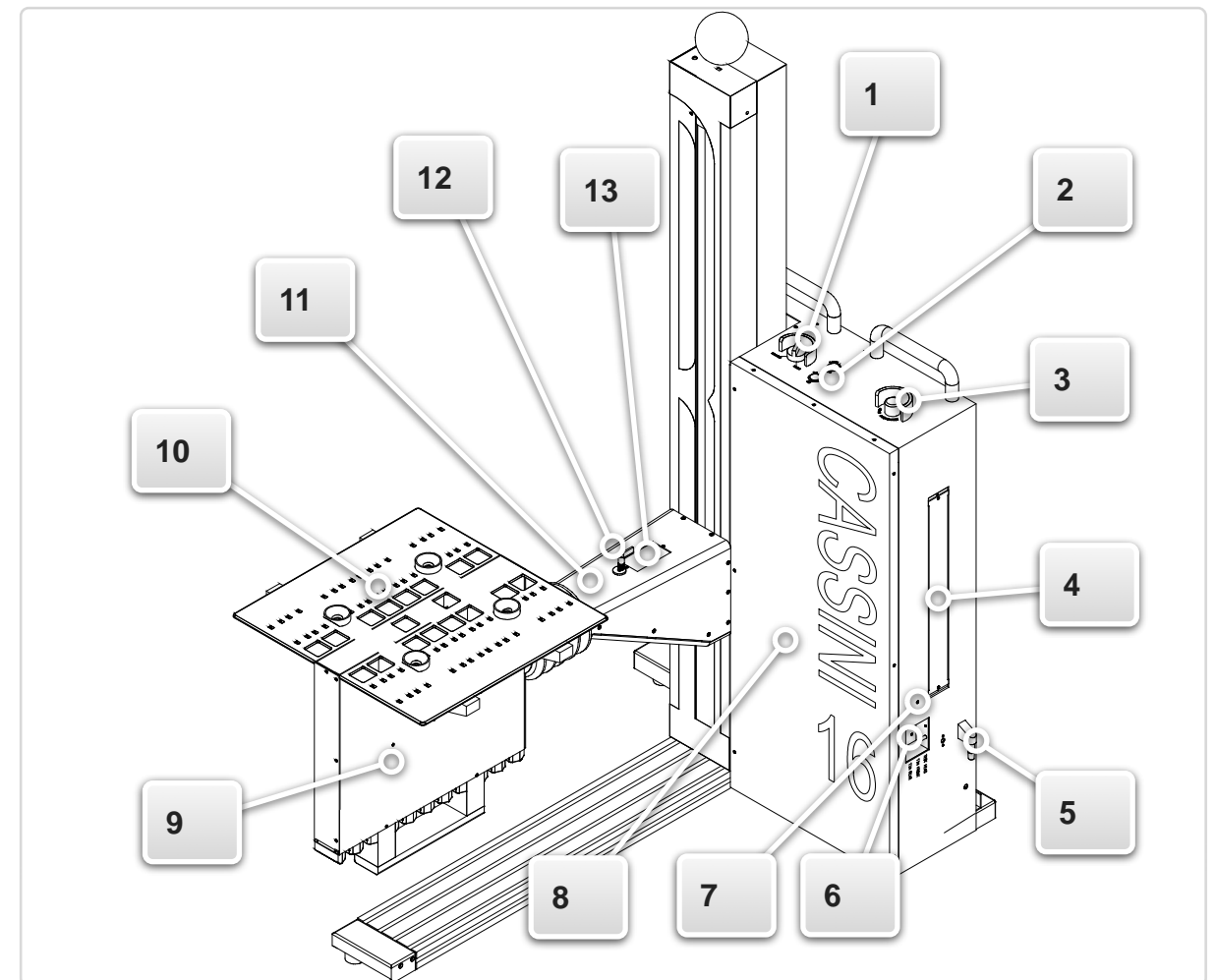
9. **Test Head Rotation Lock** - Rotational knob that locks and unlocks the test head rotation.
10. **Fixture Docking Indicators** - Two multi-color LEDs (ALIGN/DOCK) that indicate the docking status of fixtures or diagnostic/calibration plates.
11. **Serial Number** - Infrastructure identification and Guru ID.

The following numbered components reference [Figure 1.17](#).

1. **Fixture Docking Switch** - rotary switch for controlling the pneumatic fixture docking system. The 'Latch' setting locks a fixture to the test head. The 'Unlatch' setting unlocks a fixture from the test head.
2. **Test Head Elevation Control** - two push button switches 'UP/DOWN' for raising and lowering the test head and manipulator arm.
3. **Emergency Off (EMO) Button** - emergency off button for the test system.
4. **AC/DC Power Supply Access Panel** - access panel to the infrastructure AC to DC switching power supply.
5. **Compressed Air Intake** - compressed air input for the pneumatic fixture docking system.

6. **Secondary Breakers** - multiple circuit breakers that interrupt power to the test head power supply in the test system in the event of an excess current fault condition. The switch can be manually operated to de-energize the test head and infrastructure power.

FIGURE 1.17 CASSINI 16 FRONT VIEW



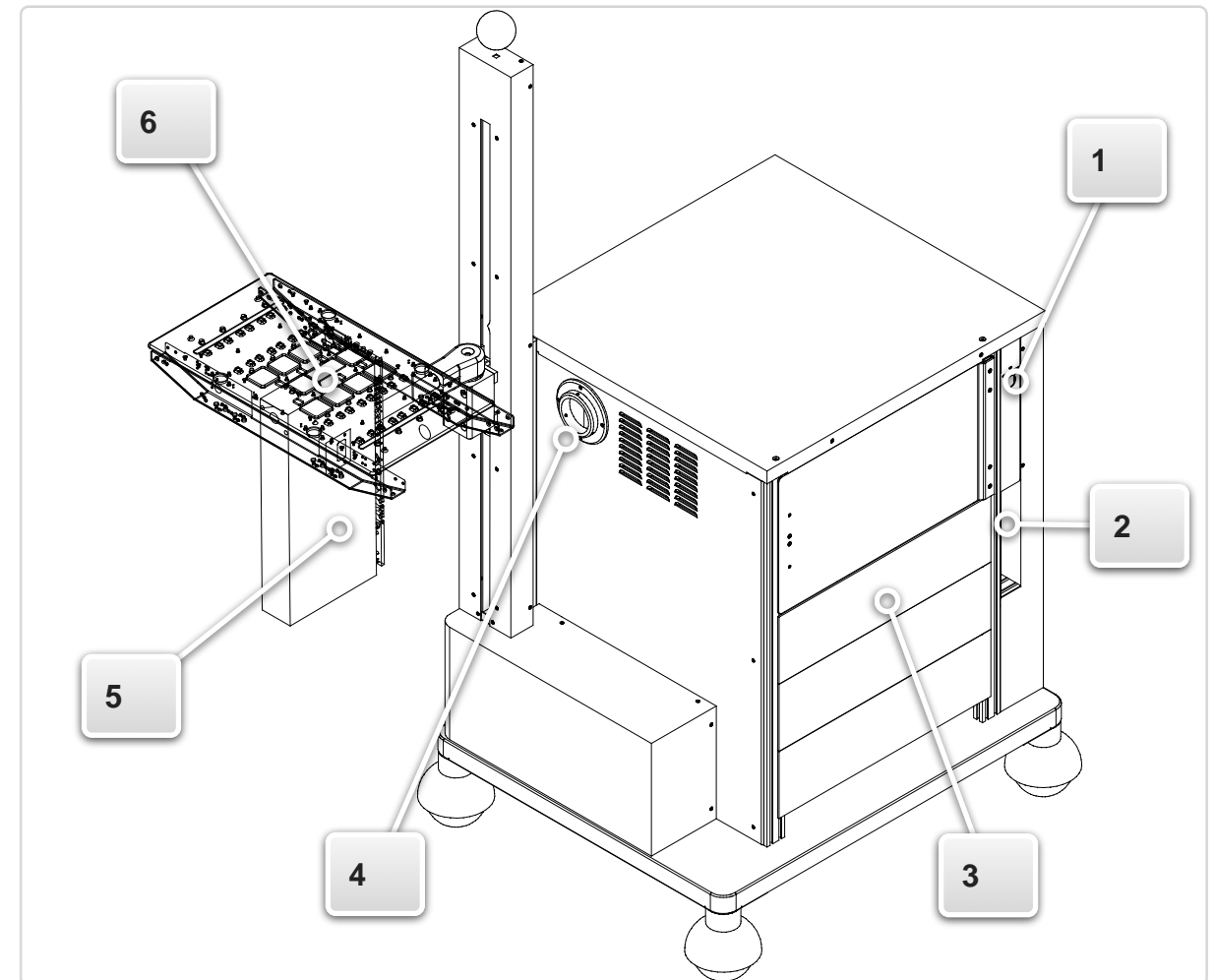
7. **Green Handler/Prober Grounding Cable with Alligator Clip** - attach this green ground cable directly to the Handler/Prober's ground. Optionally, connect AUX Rack Ground to this location.
8. **Infrastructure Access Panel** - aluminum panel can be removed to provide access to the infrastructure AC/DC power supply and supporting circuitry.
9. **Test Head Access Panel** - aluminum panel that can be removed to provide access to the test head RIFL hub and supporting circuitry.
10. **Test Head (T-Slots)** - Anodized aluminum plate with 16 universal Test Instrument Module slots and fixture (FIX) interface.
11. **Manipulator Arm** - armature with 6 degrees of freedom for positioning and supporting the test head.
12. **Manipulator Lock** - Locking pin for fixing the manipulator arm into the 'Maintenance Position' during service or repair and allowing planar movement of the test head in the 'Docking Position.' Pulling the locking pin upwards and rotating the head 180 degrees, unlocks the manipulator arm for fine planar positioning of the test head. To lock the manipulator arm in the maintenance position, rotate the locking pin head until the pin recesses into the locking position. Using blue dot of the docking position indicator, move the test head into the 'Maintenance Position' until the locking pin engages with an audible click.
13. **Docking Position Indicator** - provides a blue dot indicator for position reference of the test head in either the locked 'Maintenance Position' or with planar movement freedom when in the 'Docking Position' setting.

## SMALL CASSINI

The following numbered components reference [Figure 1.18](#).

1. **OFF/ON/START Switch** - rotary switch used to power on or power off the test system controller.
2. **Main Breaker** - primary test system circuit breaker that interrupts the power to the AC/DC power supply in the test system in the event of an excess current fault condition. The switch can be manually operated to de-energize the test system.
3. **Instrument Rack** - test system equipment rack for storing RI7725/7710 Sources, 7000 series instruments, and test controller.
4. **Cable Feed Port** - an opening in the workstation infrastructure for routing DC and RF cables to the test head within a flexible cable accordion boot.
5. **Test Head Access Panel** - aluminum panel that can be removed to provide access to the test head RIFL hub and supporting circuitry.
6. **Test Head** - Anodized aluminum plate with 8 universal test instrument module slots and fixture RIFL interface block.

FIGURE 1.18 CASSINI 8 FRONT VIEW



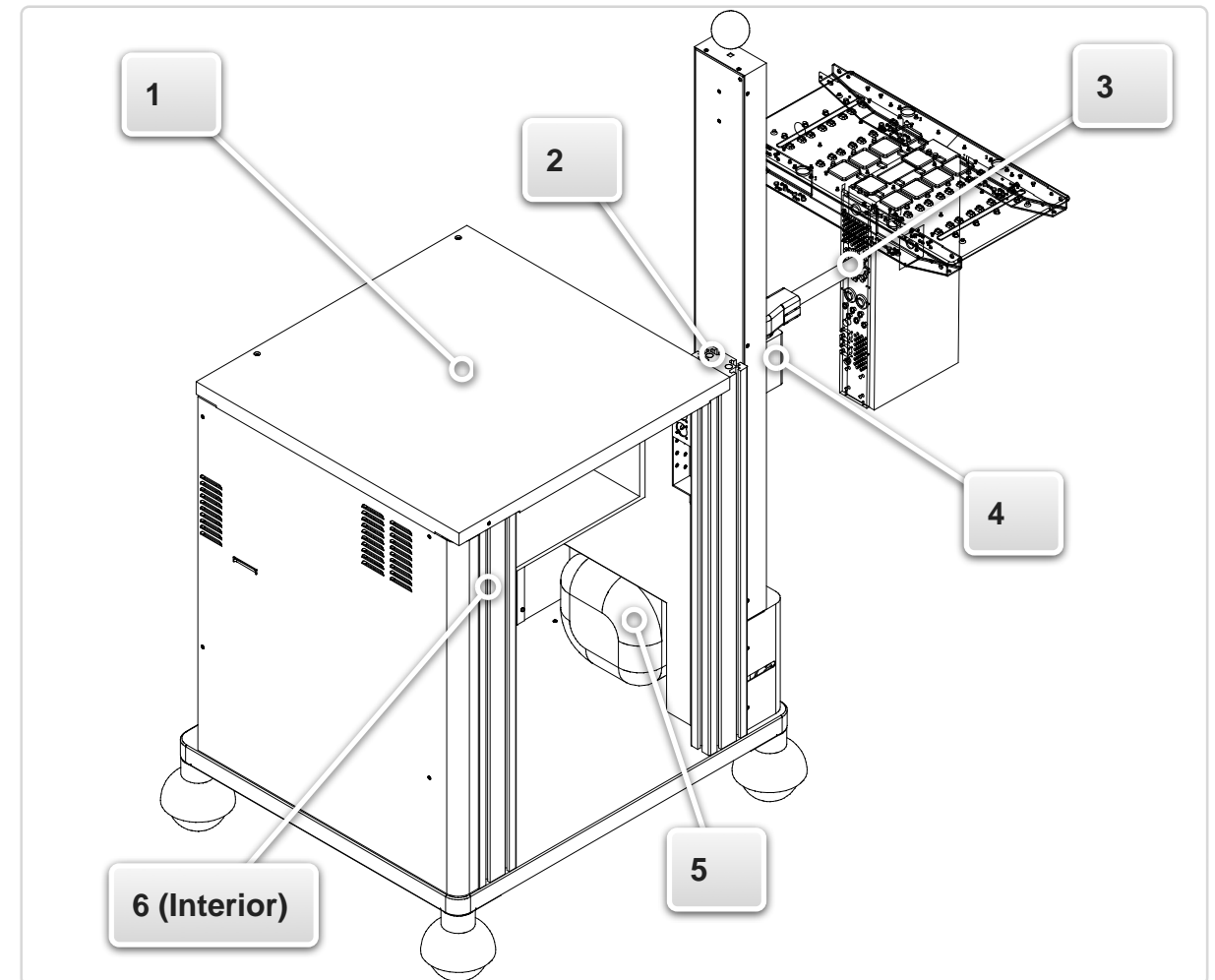
The following numbered components reference [Figure 1.19](#).

1. **Workstation** - integrated operator workstation for monitors, keyboard, etc.
2. **Fixture Docking Switch** - solenoid switch control for docking/undocking a fixture to the test head. Depressing the bottom allows the lock to be manually actuated for locking a fixture to the test head or unlocking a fixture for removal from the test head.

*NOTE: Depressing the solenoid release switch for an extended period of time (> 5-10 seconds) results in excess current through the switch. To prevent damage, the button has a built-in, cool down mode before reuse. The button will flash indicating the solenoid release is temporarily disabled during this cool-off period.*

3. **Test Head Rotation Lock** - the sliding handle on the manipulator arm locks or unlocks the test head rotation position.
4. **Test Head Elevation Control** - pull button knob that releases the test head elevation lock to manually raise or lower the test head and manipulator arm.
5. **Tool Balancer** - the lift-assist mechanism for raising and lowering the test head.

FIGURE 1.19 CASSINI 8 REAR VIEW



6. **48V Distribution Breakers** - circuit breakers that interrupt 48V power to the test head and controller in the test system in the event of an excess current fault condition. The switch can be manually operated to de-energize the test head and system controller.



## LARGE CASSINI

The following numbered components reference [Figure 1.20](#).

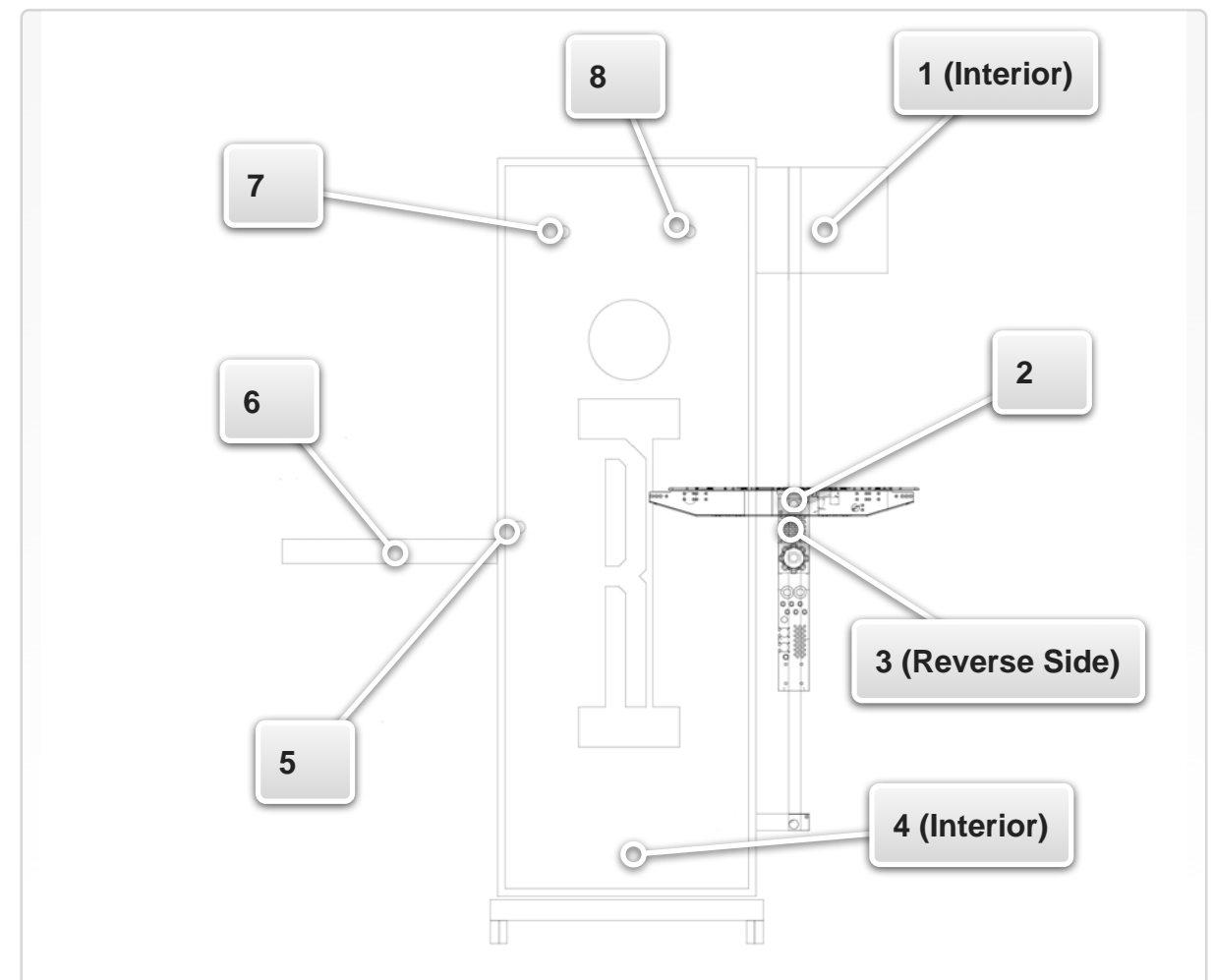
1. **Tool Balancer** - the lift-assist mechanism for raising and lowering the test head.
2. **Test Head** - anodized aluminum plate with 8 universal test instrument module slots and fixture RIFL interface block.
3. **Fixture Docking Switch** - solenoid switch control for docking/undocking a fixture to the test head. Depressing the bottom allows the lock to be manually actuated for locking a fixture to the test head or unlocking a fixture for removal from the test head.

*NOTE: Depressing the solenoid release switch for an extended period of time (> 5-10 seconds) results in excess current through the switch. To prevent damage, the button has a built-in cool down period before reuse. The button will flash indicating the solenoid release is temporarily disabled during this cool-off period.*

4. **48V Distribution Breakers** - circuit breakers that interrupt 48V power to the test head and controller in the test system in the event of an excess current fault condition. The switch can be manually operated to de-energize the test head and system controller.
5. **Rack Access Lock** - rotational knob for accessing the instrument rack and equipment.

6. **Workstation Surface** - an optional workstation table for placing computer/controller monitor, keyboard, and/or mouse.
7. **OFF/ON/START Switch** - rotary switch used to power on or power off the test system controller.
8. **Emergency Off (EMO) Button** - emergency off button for the test system.

FIGURE 1.20 LARGE CASSINI (BIG CASSINI) FRONT VIEW



## TEST HEAD

Cassini test systems include a manipulator arm and configurable test heads that are designed for Roos Instruments test instrument modules (TIMs). The test heads support eight (Cassini8 or Large Cassini) or 16 TIM slots to allow a completely configurable test head for different applications, test floors, sites, or customers. TIMs are designed with quick release latches and blind mate connectors that are designed to allow multiple features:

- System is easy add, remove, and configure test head resources
- Unified test head plane with easy access to TIM resources
- Simplified fixture docking and instrument resource interfacing
- 48V-supplied TIM power and RIFL data bus connections

The manipulator arm allows movement of the test head with compliance for various handler and prober setups. Small Cassini and Large Cassini models allow 2-axis of movement: vertical lift and 225 degrees of test head rotation. Cassini 16 allows for 6 axes of test head movement: vertical lift, 2-axis fine planar movement, 2-axis of gimbal movement, and 225 degrees of rotation (see [Figure 1.22](#)). All Cassini test systems contain a RIFL test head hub that connects TIMs to the RIFL hub. The RIFL hub of Small Cassini and Large Cassini have eight instrument nodes with 12 contact pads that connect the TIMs RIFL pogo pins to the controller bus as shown in [Figure 1.23](#) and [Figure 1.25](#). The Cassini 16 test system contains two, eight slot nodes as shown in [Figure 1.21](#) and [Figure 1.24](#). The 'Front Test Head'

hub provides RIFL connection for TIMs in slots 5 through 8 and 13 through 16. The 'Rear Test Head' hub provides RIFL connection for TIMs in slots 1 through 4 and 9 through 12.



## FIXTURE POWER

DC power is provided for active devices inside the fixture. Additionally, open-collector drivers are provided for controlling switches inside the fixture.

## FIXTURE DC POWER

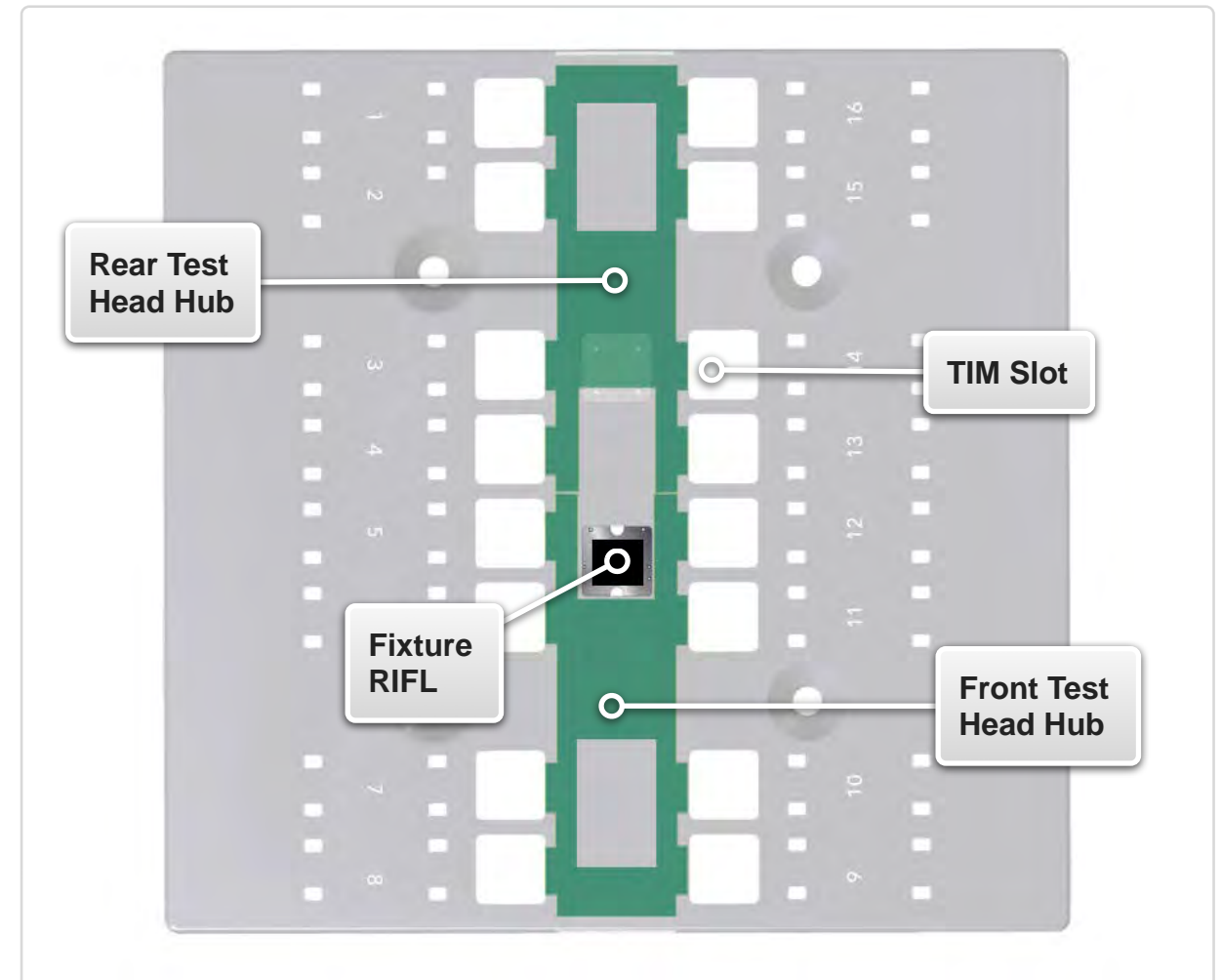
Fixture Control Lines (cbits)

Open-collector lines, available for controlling switches or other devices inside the fixture.

- Quantity: 8
- Low Voltage (typical): 0.5V
- Maximum current, per line: 0.1A
- Maximum combined current, all 8 lines: 0.5A

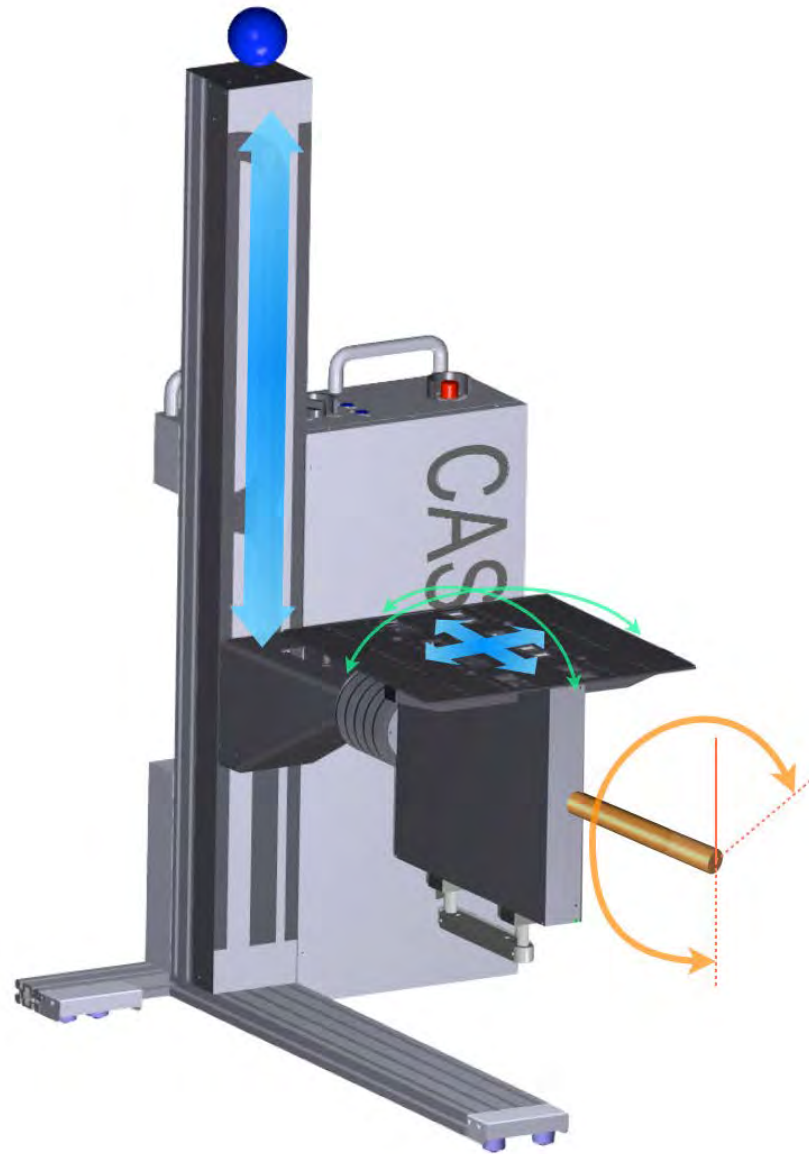
*NOTE: A smart fixture uses approximately 0.13 amps from the fixture +5V. If a smart fixture is used, the maximum available current from the fixture +5V is 1.37A.*

FIGURE 1.21 CASSINI 16 TEST HEAD LAYOUT



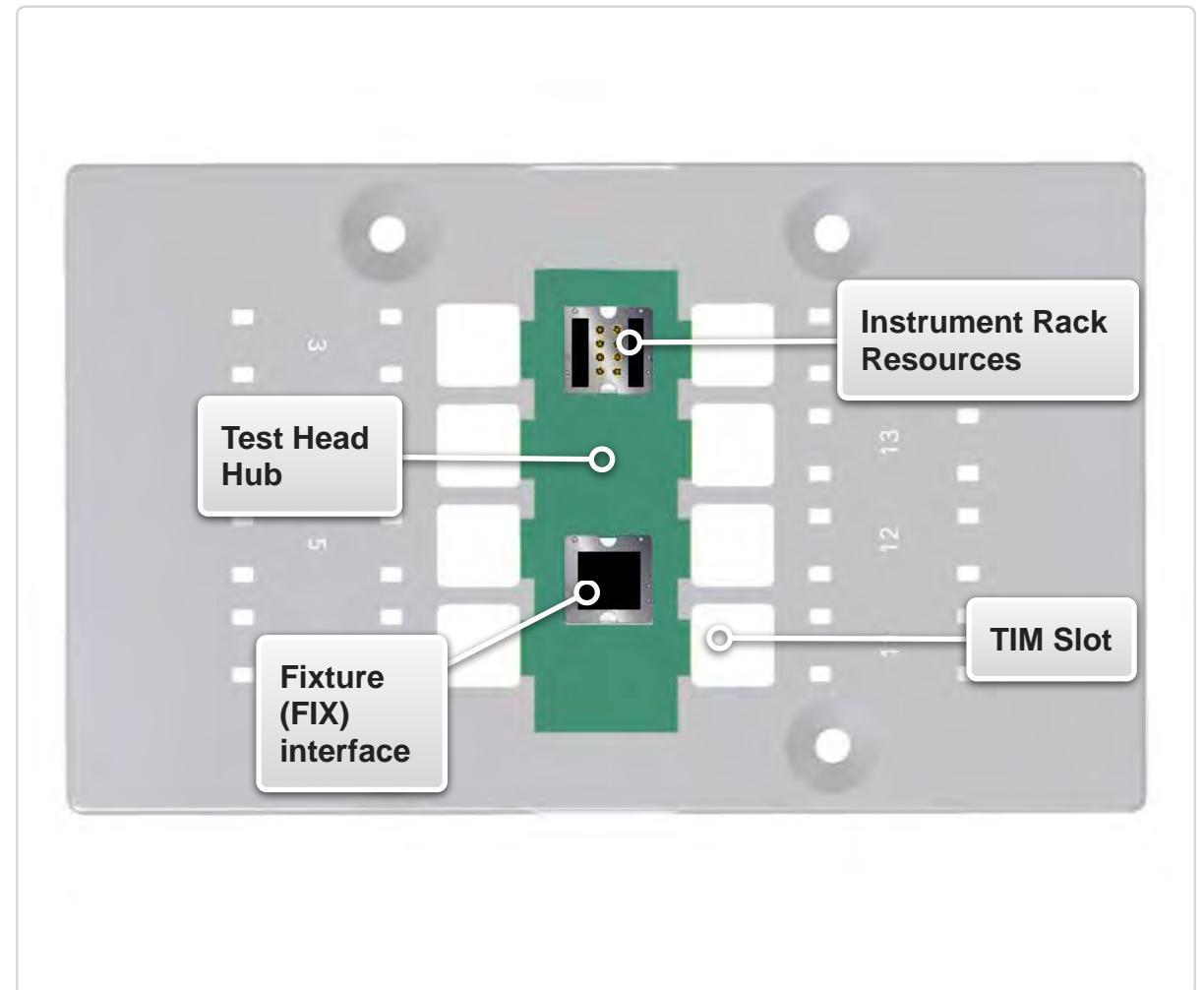
The illustration above shows a top-down view of the Cassini16 test head (shown transparent) with the locations of the Front and Rear test head RIFL hubs, and the fixture RIFL blind-mate interface.

FIGURE 1.22 CASSINI 16 TEST HEAD ARTICULATION



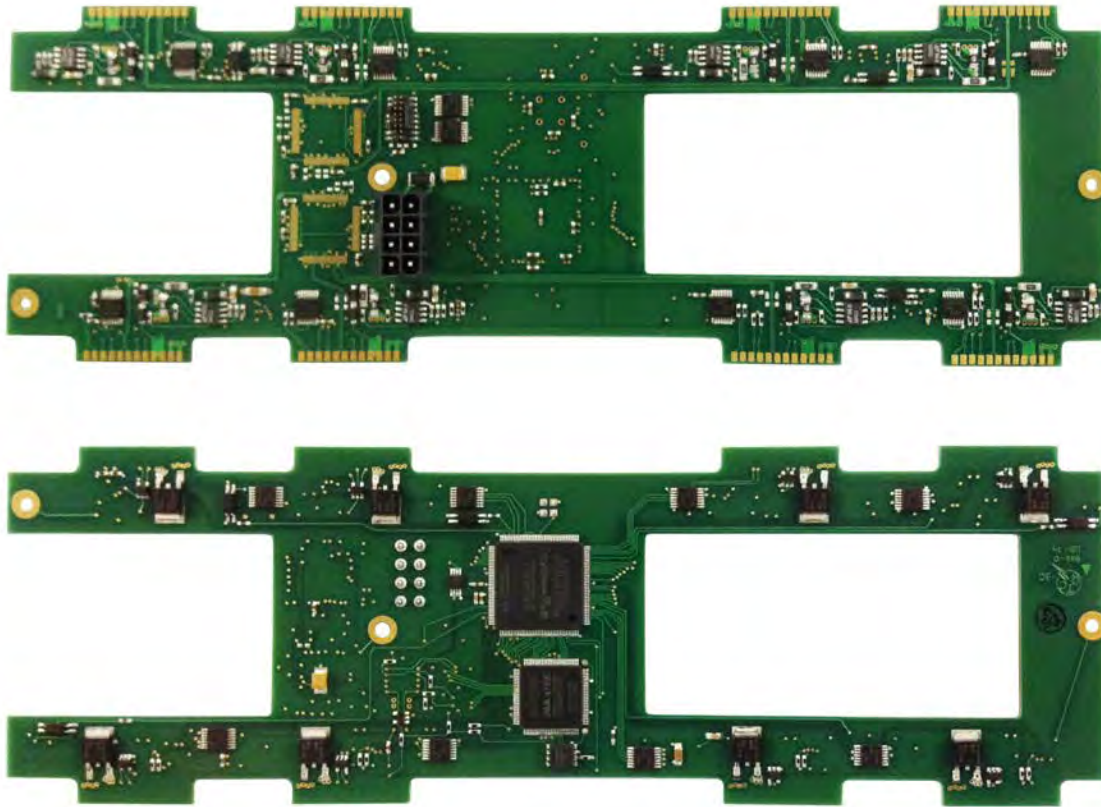
The manipulator arm can be elevated (blue) and the test head allows gimbal movement (green), 2 axes of fine planar movement (blue) and 225 degrees of rotation (orange).

FIGURE 1.23 CASSINI8/RI7100C TEST HEAD LAYOUT



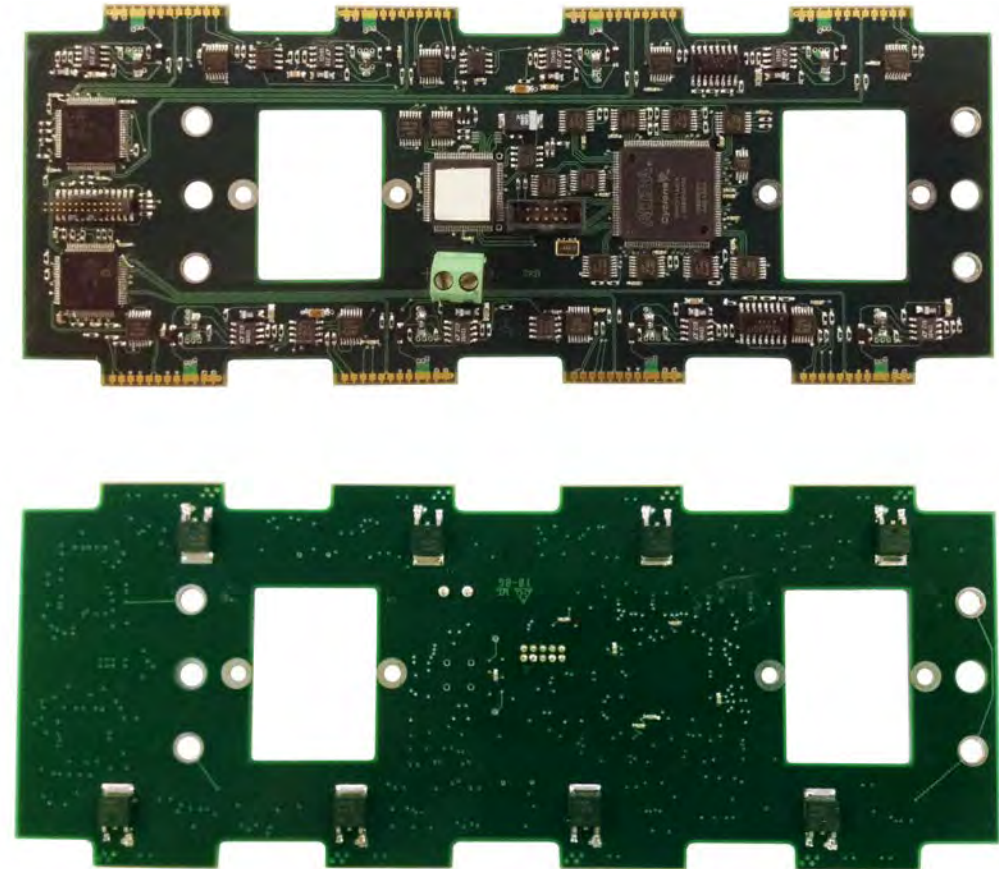
The illustration above shows a top-down view of the Cassini 8/RI7100C test head (shown transparent) with the location of the test head RIFL hub, fixture FIX blind-mate interface, and instrument rack resources(DC/RF) blind-mate interface.

FIGURE 1.24 CASSINI 16 TEST HEAD RIFL HUB (1 OF 2)



The picture above shows the bottom or TIM view(top) and the top or test head plate view(bottom) of one of the two 8 slot RIFL hubs used in the Cassini 16 test heads. Two of these hubs located on the underside of the test head to connect up to 16 TIMs to the RIFL data bus. The tabs on the PCB provide 12-pad RIFL interface pressure contacts with the 12-pin pogo blocks found on the test instrument modules.

FIGURE 1.25 8 SLOT TEST HEAD RIFL HUB



The picture above shows the bottom or TIM view(top) and the top or test head plate view(bottom) of the 8 slot hubs used in the Cassini 8 and RI7100C test heads. The hub is located on the underside of the test head to connect up to 8 TIMs to the RIFL data bus. The tabs on the PCB provide 12-pad RIFL interface pressure contacts with the 12-pin pogo blocks found on the test instrument modules..

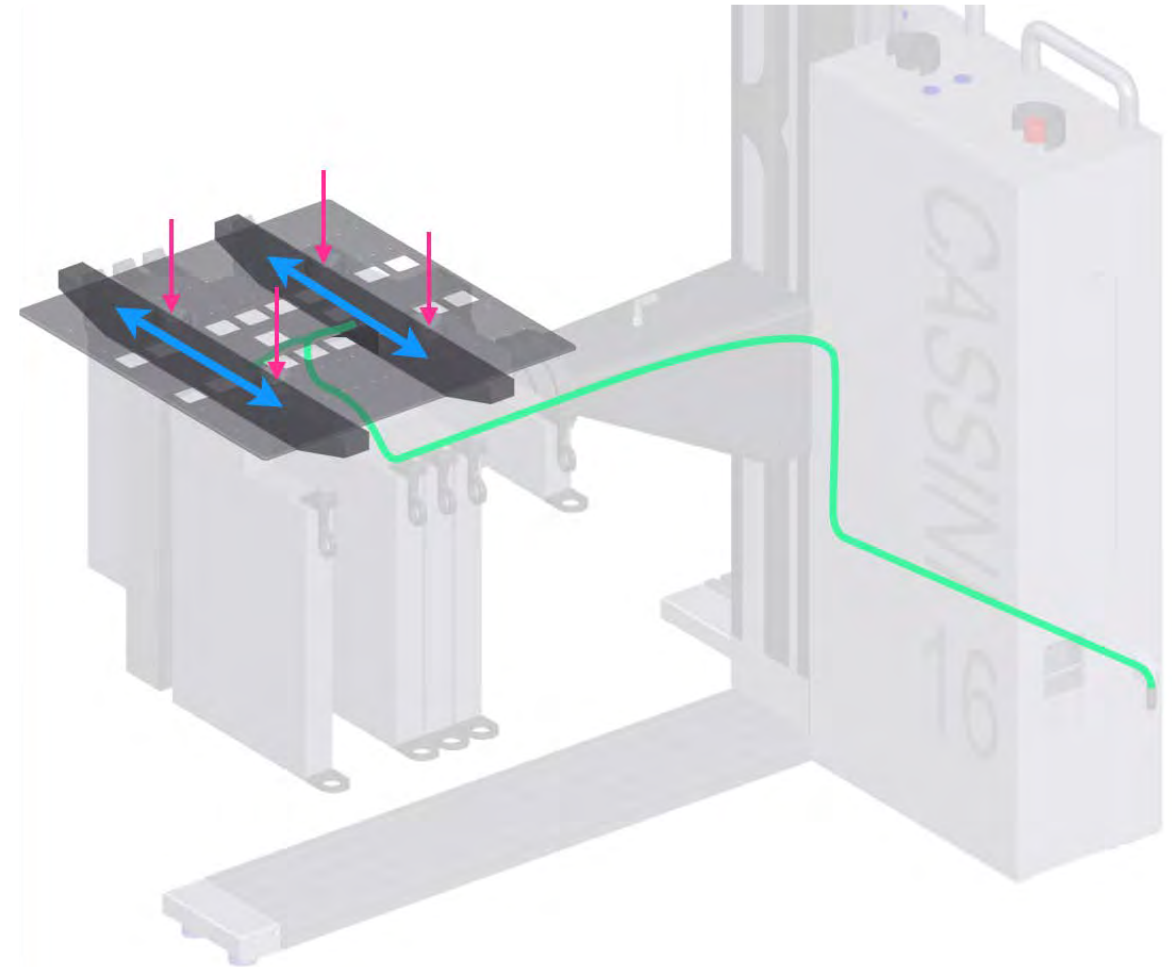


## FIXTURE DOCKING SYSTEM

Cassini test heads include a specialized, blind-mate TIM interface system for fixtures. Four receive ports on the test head connect fixture docking pins to a mechanical lock system. The system uses two canoe-shaped slide locks to engage the docking pins. The Small Cassini and Large Cassini systems provide a solenoid release switch to manual actuate the fixture lock system. The Cassini 16 test system uses a pneumatic (forced air system) to lock the fixture docking pins with mechanical canoe locks, securing the fixture to the test head as shown in [Figure 1.26](#). Alignment and keyed-guide pins between the fixture mating blocks and the TIM blind-mate interface, insures proper alignment and compliance.

See [Inserting and Removing Fixtures](#) for the detailed docking procedure.

FIGURE 1.26 CASSINI 16 PNEUMATIC FIXTURE DOCKING SYSTEM



The diagram above shows the various components of the fixture locking system. Forced air from the air hookup (green) is regulated to provide consistent locking force of approximately +100 lbs. between the blind-mate fixture blocks and the TIM interfaces. Fixture docking pins engage the u-bars (red arrows) at four locations on the test head for uniform force distribution. The u-bar locks move horizontally to engage the fixture docking pins and secure the fixture.

# SYSTEM CONTROLLER

The System Controller provides the embedded user interface, multi-instrument control, and graphical test programming environment for the Cassini ATE system. Instrument control and management are provided via the RIFL (Roos Instruments Fast Link) bus. RIFL provides the communication bus as well as distributing 48V instrument power and a shared 10 MHz reference clock across the instrument test head. The controller provides networked data storage and communication capabilities (Guru™) via a standard CAT-5 connections with local storage for online and offline development and USB ports for non-network data transfer. Guru™ provides tools for organizing files, data, and software test resources along with built-in file versioning, automated backups, data and test distribution control, access control and more.

On Cassini 16 test systems, the system controller is a TIM that is connected to the rear side of the infrastructure chassis as shown in [Figure 1.16](#). On Small Cassini and Large Cassini infrastructures, the system controller is an instrument module located in the workstation/instrument rack.

## INSTALLATION

### CASSINI 16

Before installing a System Controller:

- Exercise proper ESD procedures with the Cassini test system and System Controller TIM.
- Verify that the system is powered down: OFF/ON/START knob is in the OFF position, the main breaker switch is in the OFF position and the secondary breakers are in their OFF positions.
- Inspect the TIM to insure that no damage has occurred to the chassis or RIFL block interface and check that air exhaust channels are free of debris. Verify that mechanical components such as the bottom and top latch releases and locks are operating correctly and that the computer ports and pins: VGA, serial, parallel, USB, and PS/2 are not damaged.

### TO INSTALL A CASSINI 16 SYSTEM CONTROLLER:

1. Hold the TIM using the top and bottom latch releases in the unlocked position with the blind-mate interface facing down.
2. Guide the system controller into place in the infrastructure controller slot located on the backside of the test system chassis.

3. Verify that the RIFL block and pogo pins of the system controller align properly and make good contact with the chassis RIFL master pads.
4. Release the bottom latch handle to engage the detent lock and engage the top-latch by pressing the knob inwards toward the TIM to lock the system controller into place.
5. Verify that the controller is seated and secured firmly in place before proceeding.

*NOTE: The system controller must be installed in order to control the pneumatic fixture docking system and to supply 48V to the front and rear test head RIFL hubs.*

6. Connect the computer peripherals: keyboard, monitor, mouse or touch screen, to their associated IO port on the system controller.
7. Connect the System Controller's ethernet port located adjacent to the bottom latch to a standard CAT-5 RJ45 ethernet network cable to connect the test system with a Guru Server.

## SMALL CASSINI AND LARGE CASSINI

The system controllers are pre-installed into the instrument racks. To remove, service, or replace system controllers for the Large Cassini or Small Cassini test systems, contact Roos Instruments at [support@roos.com](mailto:support@roos.com).

## START UP PROCEDURE

To perform a standard start up, use the procedures outlined below for the appropriate Cassini system.

*NOTE: There is a recommended 2 hour minimum warm up time for test systems before calibrations should be run on test systems with RF test instrument modules (TIMs). RF TIMs contain temperature control systems designed to maintain a pre-defined temperature for internal instruments and components to insure consistent measurement accuracy.*

## CASSINI 16

Insure that the test system has been installed correctly and in accordance with the requirements listed in the [Site Preparation](#), [Shipping and Unpacking](#), and [System Installation](#) instructions.

1. Move the system into final operating position, ready for docking with a Handler or Prober (if applicable).
2. If a fixture is attached, [undock the fixture](#) from the test head.

**WARNING: The DUT, DIB or Fixture could be damaged if the Fixture is latched while the system is starting up. Never add or remove TIMs while the Fixture is latched to the test head.**

3. Verify that AC power has been connected to the infrastructure and the rotary OFF/ON/START knob is in the OFF position.

4. Insure the pneumatic air hose is connected to a compressed air source with required pressure specified in the site preparations information.
5. Insure the system controller is installed and locked into the infrastructure and that all computer peripherals (CAT-5 Ethernet, monitor, keyboard, mouse, touch screen, etc.) are connected to the controller before powering up the system.
6. Confirm the Main Breaker switch located on the rear, lower left side of the infrastructure chassis is in the ON position. Also confirm the secondary breakers, located adjacent to the forced-air hookup, are in the ON position.

*NOTE: Depending on the model year, the number and naming of secondary breakers may vary. For newer models -- switch ON the 'MAINFRAME' switch followed by the 'HEAD' switch. For early models -- switch ON the 'Test Head' followed by the 'TIM FRONT' and then the 'TIM REAR' switch.*

7. If not already attached, TIMs and auxiliary equipment (Handler Pod) may be connected to the test head with the system powered off adhering to the [Installing a TIM](#) procedure. Do not connect a Fixture until after the system software is running.

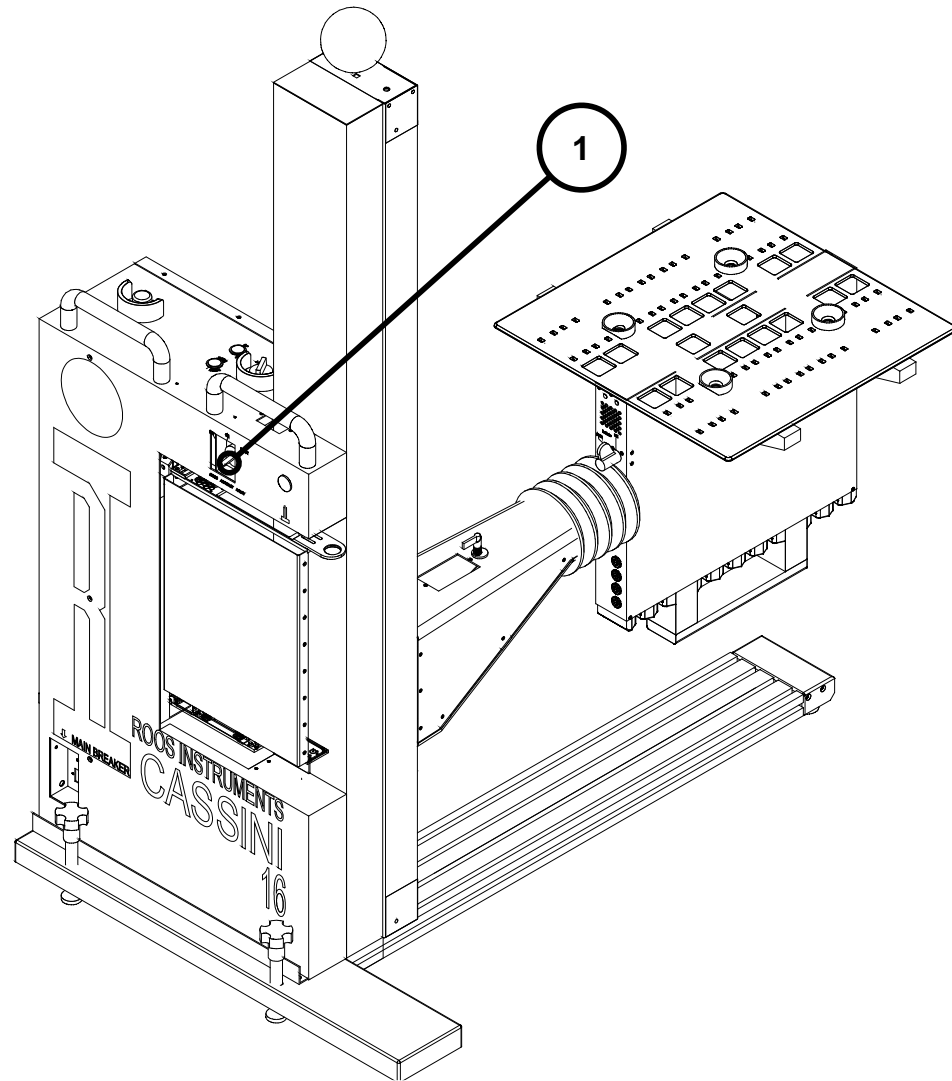
*NOTE: If a handler or prober will be used, connect the ground cable from the infrastructure to a ground plug on the handler or prober.*

8. Turn the OFF/ON/START rotary knob located on the rear side of the chassis (see [Figure 1.27](#)) from the OFF position to the ON position, and then rotate and hold it in the START position for 1-2 seconds to start up the test system. The system can take up to 3 minutes before the Guru control bar appears and the user can logon.
9. If an external monitor is used, turn on the monitor power and allow the system OS to complete start up process. If a touch screen monitor is used, the monitor power will automatically power on.
10. The user should select **Logon**, enter the username and password and press **Log On**. Then press **Short Cuts** or **User Apps** to continue loading the system software.
11. If a handler is being used, dock the Fixture to the handler and [connect the handler Pod](#) while the RI system software is loading. Once the Cassini main window appears, [dock the Fixture or Diagnostic/Calibration plate](#). Always choose **System > Check** after docking to activate the Fixture.

The system is now ready to begin testing.



FIGURE 1.27 CASSINI 16 OFF/ON/START SWITCH

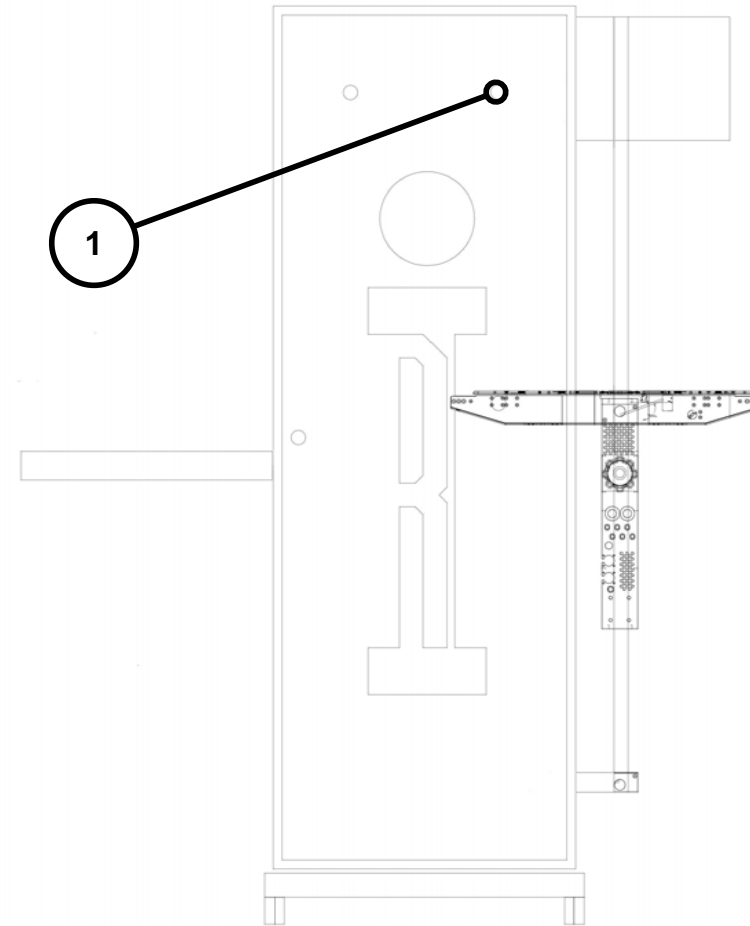


## LARGE CASSINI

Insure that the test system has been installed correctly and in accordance with the requirements listed in the [Site Preparation](#), [Shipping and Unpacking](#), and [System Installation](#) instructions.

1. Remove all fixtures, calibration/diagnostic plates, and auxiliary equipment from the test head.
2. Verify that AC power has been connected to the test system and that all breakers on the 48V distribution panel, located inside and at the bottom of the instrument rack, are in the OFF position.
3. Insure the system controller is installed in the instrument rack and locked into a rack position.
4. Verify that all computer peripherals (CAT-5 Ethernet, monitor, keyboard, mouse, touch screen, etc.) are connected to the controller before attempting to power up the system.
5. Insure all RF cables routing from the instrument rack to the test head are connected.
6. Turn on the 48V Distribution breaker switches from the OFF position to the ON position in the following sequence: 1 RACK, 3 FANS, and then 5 HEAD. Reference [Figure 1.20](#) for location.
7. Turn the OFF/ON/START rotary knob located on the front exterior of the instrument rack (see [Figure 1.28](#)) from the OFF position to the ON position, and then hold it in the START position for 2-3 seconds to start up the test system.

8. If an external monitor is used, turn on the monitor power and allow the system software to complete start up. If a touch screen monitor is used, the monitor power will automatically power on.
9. Once the system software has successfully booted, a user has logged in, and a System Check has been performed, TIMs and auxiliary equipment may be connected to the test head followed by fixtures or diagnostic/calibration plates, adhering to the procedures outlined in Section 5: Test Instrument Modules and Section 6: Fixtures.

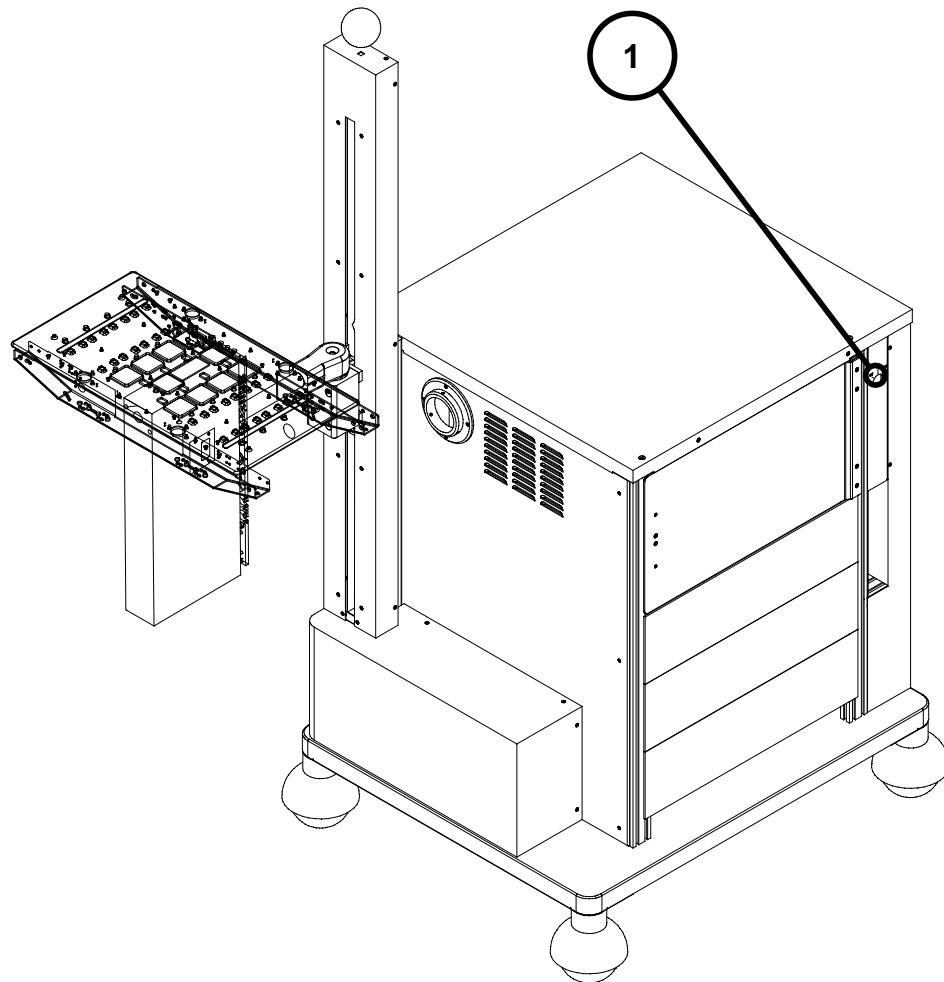
**FIGURE 1.28 LARGE CASSINI OFF/ON/START SWITCH**

## SMALL CASSINI

Insure that the test system has been installed correctly and in accordance with the requirements listed in the [Site Preparation](#), [Shipping and Unpacking](#), and [System Installation](#) instructions.

1. Remove all fixtures, calibration/diagnostic plates and auxiliary equipment from the test head.
2. Verify that AC power has been connected to the test system and that main breaker, located on the front lower right side of the workstation rack, and the 48V Distribution breakers, located in the rear of the workstation rack, are in the OFF position. Reference [Figure 1.18](#) and [Figure 1.19](#) for locations.
3. Insure the system controller is installed in the workstation rack and locked into a rack position.
4. Verify that all computer peripherals (CAT-5 Ethernet, monitor, keyboard, mouse, touch screen, etc.) are connected to the controller before attempting to power up the system.
5. Insure all RF cables routing from the instrument rack to the test head are connected.
6. Place the Main breaker switch from the OFF position to the ON position. Reference [Figure 1.18](#) for location.
7. Place the 48V Distribution breaker switches from the OFF position to the ON position in the following sequence: RACK, and then HEAD. Reference [Figure 1.19](#) for location.
8. Turn the OFF/ON/START rotary knob located on the front lower right exterior of the workstation rack (see [Figure 1.29](#)) from the OFF position to the ON position, and then hold it in the START position for 2-3 seconds to start up the test system.
9. If an external monitor is used, turn on the monitor power and allow the system software to complete start up. If a touch screen monitor is used, the monitor power will automatically power on.
10. Once the system software has successfully booted, a user has logged in, and a System Check has been performed, TIMs and auxiliary equipment may be connected to the test head followed by fixtures or diagnostic/calibration plates, adhering to the procedures outlined in Section 5: Test Instrument Modules and Section 6: Fixtures.

FIGURE 1.29 CASSINI 8 OFF/ON/START SWITCH



## SHUT DOWN PROCEDURE

To shut down a test system for routine service or maintenance, use the procedures outlined below for the appropriate Cassini system.

### CASSINI 16

1. Stop all test programs and other user programs.
2. Save edits and data from user programs in progress (if desired).
3. If a shortcut is active, close the system shortcut by selecting the **System > Quit...** menu options from the main system window or RMB click the main system window 'x' button at the top right corner.
4. The test system will prompt the user to confirm the closure of the Cassini main system window.
5. Shutdown the operating system by selecting the OS shutdown shortcut or selecting the **Shutdown...** option from the eCS Start menu located at the bottom of the screen.
6. The operating system will prompt the user to confirm the shutdown.
7. A shutdown screen animation (blink screen) followed by an audible series of beeps will prompt the user when it is safe to deactivate power.

8. After the screen animation has completed, the screen is blank, and the audible beeps begin, the user has 3-5 seconds to deactivate the controller before the test system initializes an auto start sequence.

*NOTE: If the auto start sequence has begun, let the system complete the restart before attempting to shut down.*

9. Shut down the controller power by turning the 'Main System' knob found on the controller side of the chassis (as shown in [Figure 1.27](#)) from the 'ON' position to the 'OFF' position.
10. Before performing service or maintenance to the system test head, switch the test head breakers (located next to the pneumatic hose hookup) to the 'OFF' position.
11. Before performing service to equipment in the auxiliary rack, switch the auxiliary rack breakers (located at the top interior of the rack) to the 'OFF' position.
12. Before performing service or maintenance to the infrastructure or AC/DC power supplies, switch the main breaker (located near the pneumatic hose hookup on the controller side of the tester) to the 'OFF' position.

## LARGE CASSINI

1. Stop all test programs and other user programs.
2. Save edits and data from user programs in progress (if desired).
3. If the Cassini main system window is open, close the system shortcut by selecting the **System > Quit...** menu options from the main system window or RMB click the main system window 'x' button at the top right corner.
4. The test system will prompt the user to confirm the shortcut closure.
5. Shutdown the operating system by selecting the OS shutdown shortcut or selecting the **Shutdown...** option from the eCS Start menu located at the bottom of the screen. The operating system will prompt the user to confirm the shutdown.
6. A shutdown screen animation (blink screen) will prompt the user when it is safe to deactivate power.
7. After the screen animation has completed and the screen is blank, the user has 3-5 seconds to deactivate the controller before the test system initializes an auto start sequence.

*NOTE: If the auto start sequence has begun, let the system complete the restart before attempting to shut down.*

8. Shut down the controller power by turning the 'OFF/ON/START' knob found on the front side of the system rack adjacent to the EMO switch (as shown in [Figure 1.28](#)) from the 'ON' position to the 'OFF' position.
9. Before performing service or maintenance to the system, switch the 48V breakers (located at the bottom interior of the system rack) to the 'OFF' position.

## SMALL CASSINI

1. Stop all test programs and other user programs.
2. Save edits and data from user programs in progress (if desired).
3. If the Cassini main system window is open, close the system shortcut by selecting the **System > Quit...** menu options from the main system window or RMB click the main system window 'x' button at the top right corner.
4. The test system will prompt the user to confirm the shortcut closure.
5. Shutdown the operating system by selecting the OS shutdown shortcut or selecting the **Shutdown...** option from the eCS Start menu located at the bottom of the screen. The operating system will prompt the user to confirm the shutdown.
6. The operating system will prompt the user to confirm the shutdown.

7. A shutdown screen animation (blink screen) will prompt the user when it is safe to deactivate power.
8. After the screen animation has completed and the screen is blank, the user has 3-5 seconds to deactivate the controller before the test system initializes an auto start sequence.

*NOTE: If the auto start sequence has begun, let the system complete the restart before attempting to shut down.*

9. Shut down the controller power by turning the 'OFF/ON/START' knob found on the front-right side of the system rack (as shown in [Figure 1.29](#)) from the 'ON' position to the 'OFF' position.
10. Before performing service or maintenance to the system, switch the test head and main breakers (located on the front-right side of the system rack beneath the OFF/ON/START switch) to the 'OFF' position.



# TEST INSTRUMENT MODULES



## TOPICS

---

[Form Factor](#)

[Dual Latch System](#)

[Signal & Communication Interfaces](#)

[Inserting & Removing](#)

[Shipping & Receiving Requirements](#)



# INTRODUCTION

At the heart of Cassini's configurable architecture are Test Instrument Modules (TIMs). These self-contained, swappable instruments provide all the source, receive, measure, and signal processing capabilities for a broad range of DC, digital, mixed-signal, RF, and millimeter-wave applications. Each TIM contains an instrument or multiple instruments with a targeted feature sets specific to a test application.

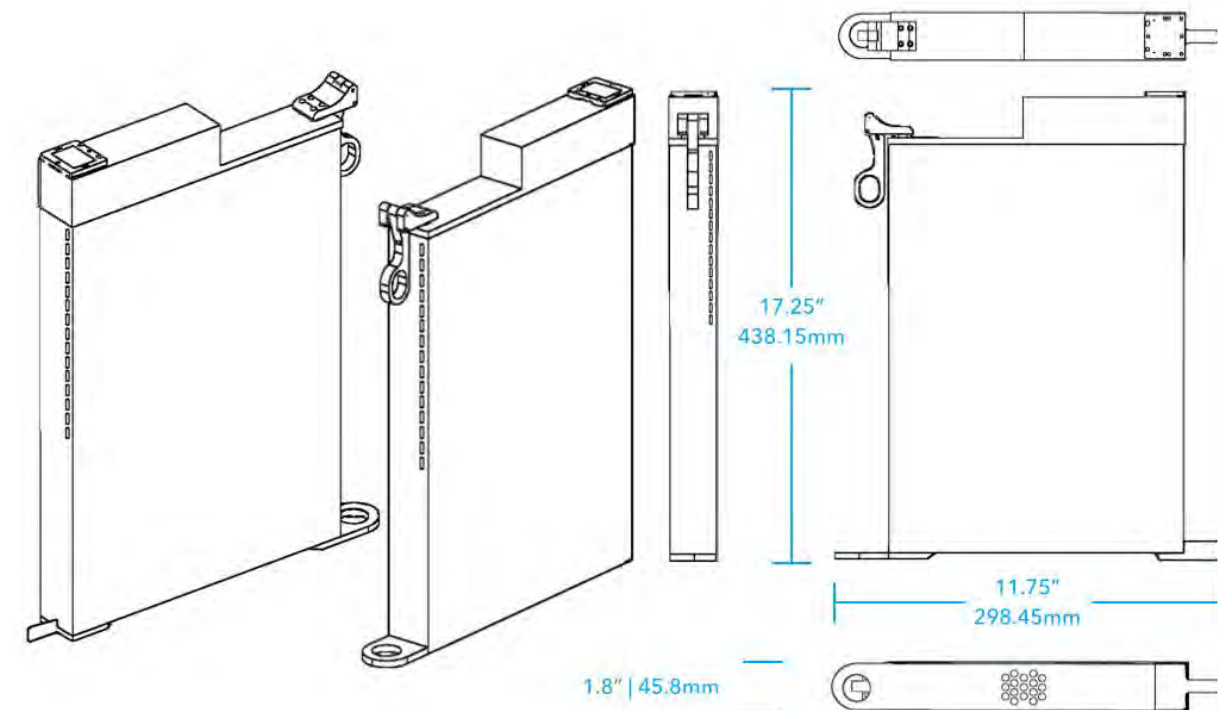
As the entire test system is modular, RF TIMs were designed to integrate with each other to provide enhanced feature capability such as multi-path switching, resource sharing, signal combination, multi-instrument measurement, frequency translation, and more. In this section the user will find introductory information about the TIM hardware, capability, and software control.

## FORM FACTOR

Test Instrument Modules use a standardized design to support Cassini's modular test head slots. This allows for completely configurable instrument layouts on the test head. An aluminum frame and panel covers protect instrumentation while keeping TIMs both light and portable for swapping and repairing. The ruggedized exterior provides a durable enclosure on the production floor with enhanced microwave shielding. Thermal exhaust ports are incorporated into the panel covers with a built-in, air-cooling system to provide stable

operating temperature. TIM dimensions of a standard can be found in [Figure 1.30](#).

FIGURE 1.30 STANDARD TIM DIMENSIONS



Standard TIM design and dimension. Examples of the different available types are shown in this gallery.



## DUAL LATCH SYSTEM

Standard TIMs, except for remote TIMs, incorporate a 2-lock system for securing the instrument to the test head. The top latch, found next to the blind-mate interface, secures the TIM to the underside of the test head by way of a preload latch. The bottom latch is then released while being pulled away from the test head.

FIGURE 1.31 DIAGRAM OF A TIM



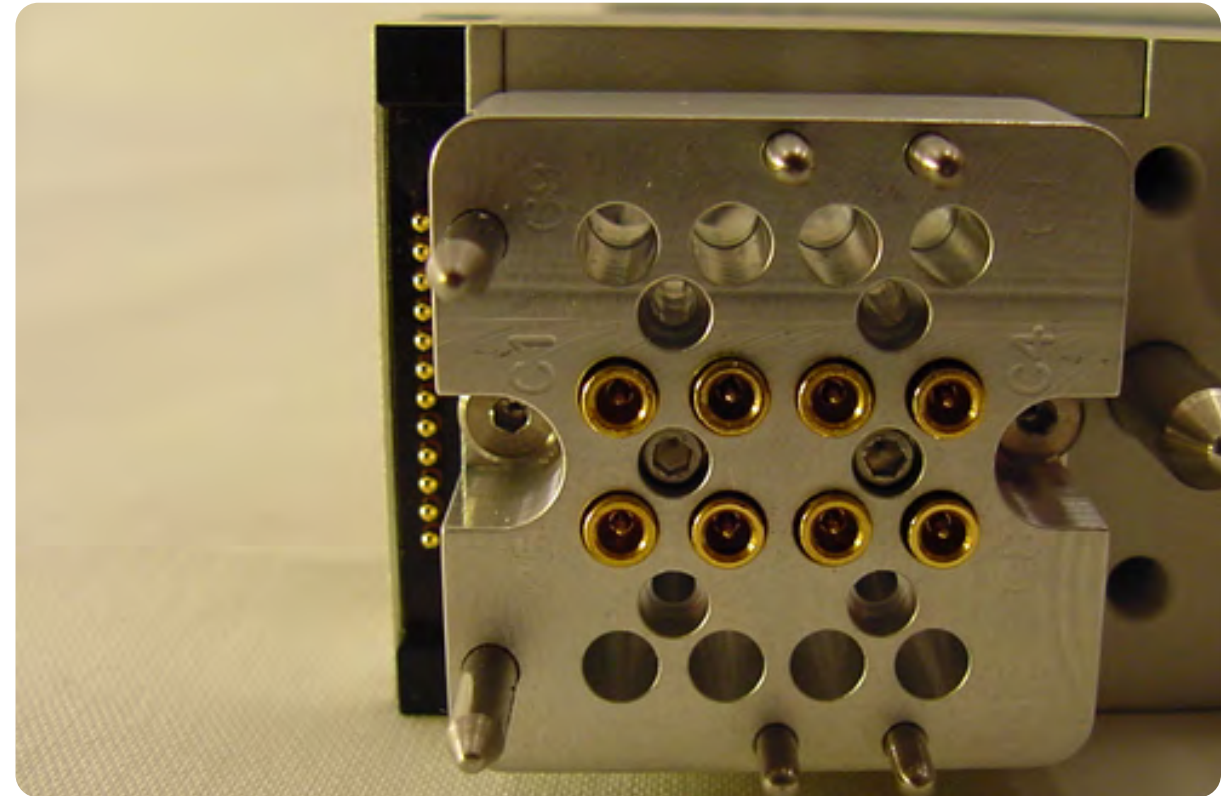
## ROOS INSTRUMENTS FAST LINK (RIFL)

RIFL is an open-standard communication and instrument power bus. The 12-pin RIFL connector block can be found next to the blind-mate TIM interface (see [Figure 1.32](#)). The block contains pogo pin contacts that interface with Cassini's RIFL hub on the underside of the test head. This bus is responsible for communication and control of the instruments from the EPC System Controller.

## BLIND-MATE INTERFACE

The resources of a TIM are accessible by way of a blind-mate connector. This system provides instrument layout flexibility and a unified test head with access to tester resources for calibration and debug purposes. DC, digital, RF and millimeter-wave ports are standardized within the test head block and are designed to mate directly with resource blocks in the device interface environment. This provides configurable cross-instrument connections and signal routing. Two alignment pins found on the top portion of the blind-mate block ensure mechanical alignment and tolerance when docking to the test head. On the sides of the block, keyed guide pins prevent accidental mismatch docking between different types of fixture blocks and TIMs. [Figure 1.33](#), [Figure 1.34](#), [Figure 1.35](#), [Figure -.-](#), and [Figure 1.36](#) provide examples of the different types of TIM interfaces.

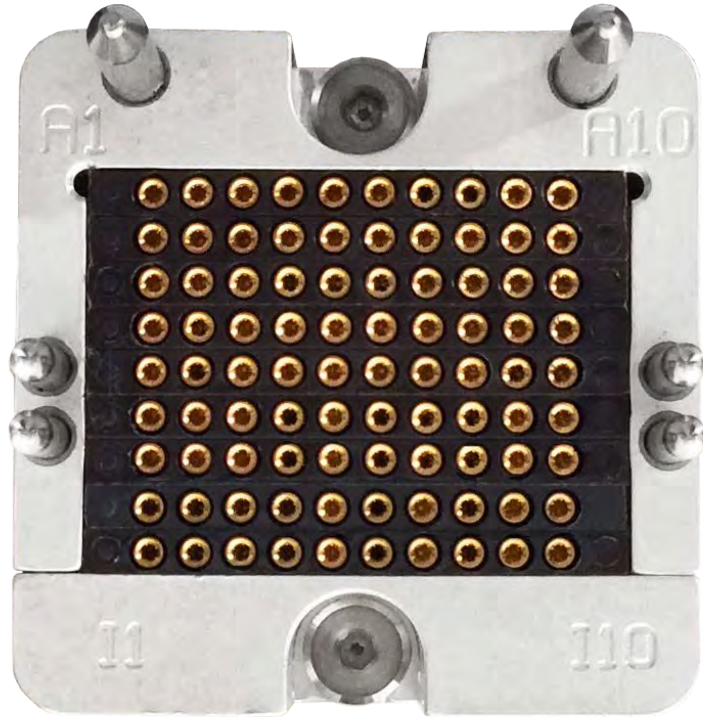
FIGURE 1.32 RIFL BLOCK



A black 12-pin RIFL connector block shown above, (just left of the blind-mate interface), carries instrument's DC power, communications, and the system's reference clock.

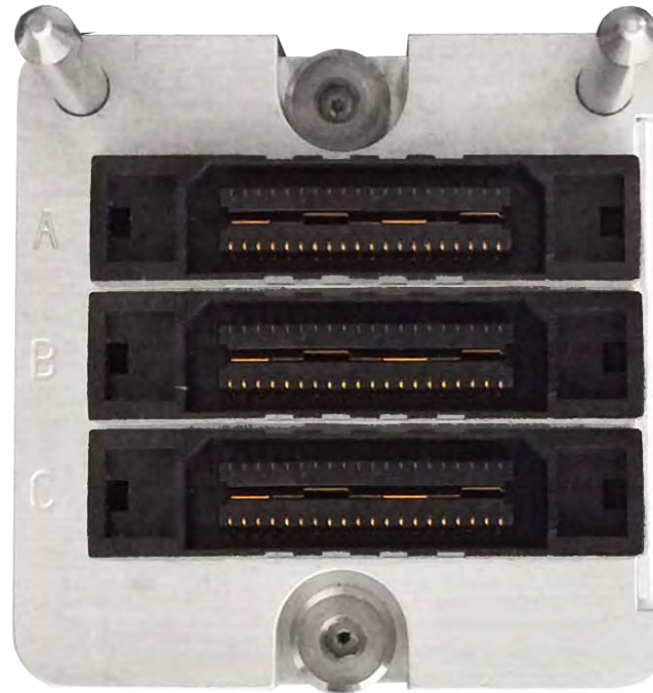


FIGURE 1.33 DC INTERFACE



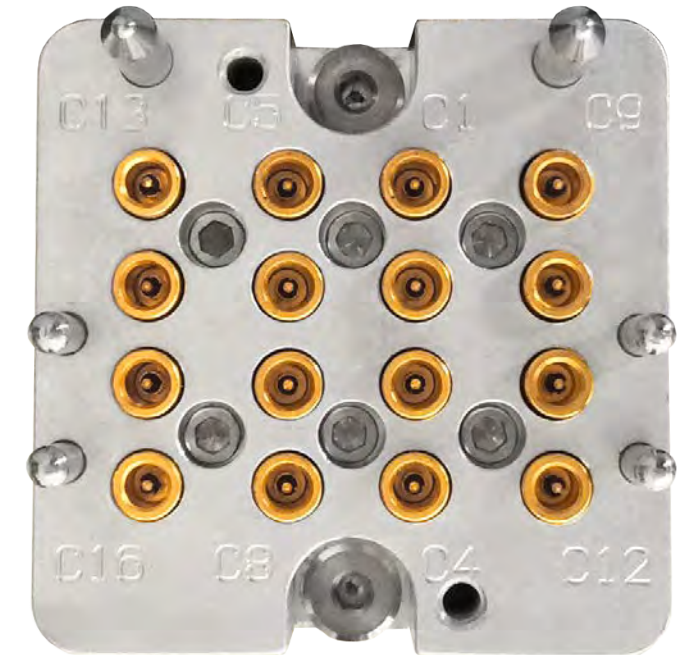
TIMs with DC resources use a precision Hypertronics pin interface. The Hypertronics connectors are designed for low-mating force requirements and high-reliability.

FIGURE 1.34 DIGITAL INTERFACE



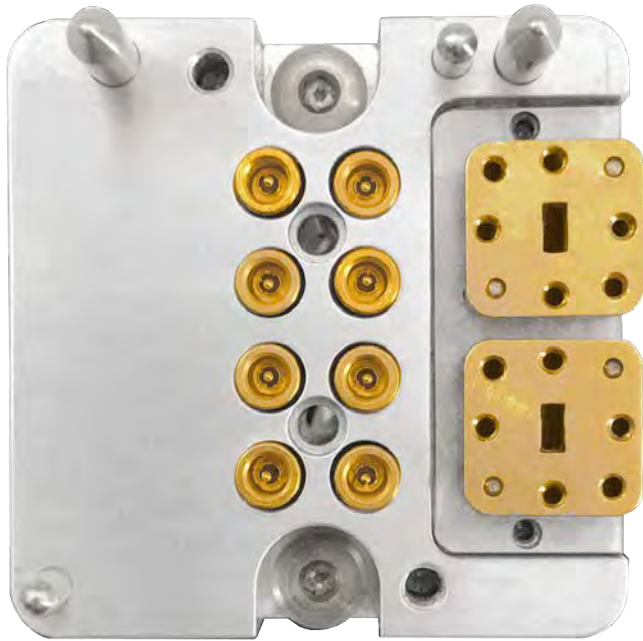
The high-speed digital TIM uses a High Density Shielded Interconnect (HDSI). These low profile, micro-miniature, ribbon coaxial cable assemblies are designed for optimal signal integrity and impedance matching up to 1 GHz.

FIGURE 1.35 RF INTERFACE



RF TIMs utilize a specialized, military-grade #12 PKZ connector. This blind-mate interface provides an inner and outer conductor separated by an air dielectric for constant impedance up to 40 GHz. The high-performance design functions across the widest mating tolerance available in any microwave blind-mate connector.

FIGURE 1.36 WAVEGUIDE INTERFACE



Millimeter wave resources are routed through a miniaturized blind-mate waveguide interface as shown above. Precision alignment pins and guides on the waveguide connector face ensure planarity and safeguard against misalignment. The frequency range of the waveguide is defined by the geometry of the center port (Typically WR-15 for 55-65 GHz range and WR-12 for 75-85 GHz).

## INSTALLING & REMOVING TIMS

TIMs were designed to be inserted and removed quickly to support the reconfigurable nature of Cassini's modular test head as well as service requirement needs. The universal test head slots and standard TIMs allow Cassini to be reconfigured in support of different applications, site, and/or customer requirements. Included in the following text are instructions for inserting and removing standard TIMs on the Cassini test head.

### INSTALLING A TIM

Before installing a TIM from Cassini's Test Head, always:

- Exercise proper ESD procedures with the Cassini test system, fixtures, and TIMs.
- Remove any fixtures or diagnostic/calibration plates from the test head to prevent damage to blind-mate interfaces.
- Perform a system check to update the system configuration before installing the TIM.
- Inspect the TIM to insure that no damage has occurred to the chassis or blind-mate interface and check that air exhaust channels are free of debris. As well, verify that mechanical components such as the bottom and top latch releases and locks are operating correctly.
- Rotate and lock the test head into the upright position as shown in [Figure 1.37](#) and set the manipulator arm in the locked 'Maintenance Lock' position.

To install a TIM to the Test Head:

1. Hold the TIM using the top and bottom latch releases in the unlocked position with the blind-mate interface facing up as shown in .
2. Bring the TIM up to the test head from underneath, using the alignment pins and blind-mate interface to guide the TIM into the test head slot.
3. When the alignment pins are visibly through the test head, the TIM's top-latch should be resting against the underneath of the test head and the clasps of the top latch should extend past the top of the test head.
4. Continuing to hold the TIM in this position, insure the bottom latch insert is aligned with the slot's associated detent receiving port.
5. Release the bottom latch handle to engage the bottom lock and continue to hold the bottom of the TIM up against the bottom side of the test head. The engaged bottom latch will prevent the TIM from accidental drops while the top latch is not engaged.
6. Engage the top latch by pressing the knob inwards toward the test head (early model versions) or by pressing the lever arm down the against the side of the TIM (late model versions).
7. Inspect the top latch clasps to insure they have engaged the top of the test head and that the TIM is securely in place.
8. Perform a software **System > Check** to activate the TIM



FIGURE 1.37 ADDING TIMS TO THE TEST HEAD



Holding the top and bottom latch releases as shown, the TIM can be aligned and inserted into the Cassini test head.

If the TIM was successfully installed, verify that the TIM's instrument resources appear in the Tester Configuration and/or equipment pool window in the appropriate test head slot.

*NOTE: Power to the TIM from the test head can be verified by checking that the instrument fan on the bottom of the TIM has powered on after the System Check.*

## REMOVING A TIM

Before removing a TIM from Cassini's test head, always:

- Exercise proper ESD procedures with the Cassini test system, fixtures, and TIMs
- Remove any fixtures or diagnostic/calibration plates from the test head to prevent damage to blind-mate interfaces
- Rotate and lock the test head into the upright position, as shown in [Figure 1.38](#), and set the manipulator arm in the locked 'Maintenance Lock' position.
- It is recommended but not required to power down the TIM before removing it from the test head.

To remove a TIM from the test head:

1. Grasp the top-latch release and pull the knob directly away from the blind-mate interface in a motion parallel to the test head plate(older model versions) or pull the top-latch handle upwards and away from the side of the TIM. This will release the TIM's top-

latch clasps from the test head and the TIM will rest on the engaged bottom latch approximately 0.25in or ~6.4mm below the test head.

2. The distance between the TIMs top latch and the test head plate will disengage the RIFL block from the 48V instrument supply and the communication bus.
3. Verify that instrument power has been removed from the TIM by performing a software System Check to confirm the TIM instruments are no longer in the Tester Configuration or Equipment Pool list. This can also be confirmed by checking that the fan on the bottom of the TIM is no longer running.
4. Holding the top latch release handle firmly, pull the bottom latch release tab directly away from the center of the test head in a motion parallel to the test head plate to release the TIM completely from the test head.
5. Move the TIM away from the test head in downward motion to prevent contacting the TIM slot RIFL pins underneath the test head and adjacent TIMs.

Always store removed or inactive TIMs in a ESD safe, temperature controlled environment.

FIGURE 1.38 REMOVING TIMS FROM THE TEST HEAD



Holding the top and bottom latch releases as shown, the TIM can be aligned and inserted into the Cassini test head.

# SHIPPING & RECEIVING REQUIREMENTS

Test instruments and TIMs should always be packaged and shipped using the Roos Instrument's provided container. DO NOT discard these containers. They are designed specifically for the instruments and TIMs with adequate sizing, anti-static material, and conformal padding to protect them during transport. If this container and shipping material are not available, contact Roos Instruments for further instructions.

Damage to TIMs, instruments, and/or equipment during shipping is the responsibility of the shipping party. Roos Instruments assumes liability for damage of equipment shipped from the factory. Roos Instruments is not liability for shipping damage of equipment shipped to Roos Instruments for service, repair, or otherwise.

---

## SERVICE INFORMATION

If a product is being returned to Roos Instruments for service, please provide enough information to help expedite repair and return of the product. For best service results, include as much information as possible: symptoms, date of failure, the current status of the instrument, etc.

Items for return must include a Return Merchandise Authorization (RMA) number. To obtain an RMA number, please email [support@roos.com](mailto:support@roos.com) or contact Roos Instruments at 1.408.748.8589 between the hours of 9:00 a.m. to 6:00 p.m. (U.S. Pacific Standard Time)

An RMA must be requested within 15 calendar days of the invoice date (ship date for credit card orders). NO returns of any type will be accepted without an RMA number and ALL returns must be shipped prepaid and insured via any common carrier (i.e. UPS, FedEx). Tracking information is required.

---

## PACKAGING A TIM

Proper packaging of TIMs prevents damage and improves response time for repair and replacement. Every TIM should be individually boxed with the supplied shipping container and packaging provided by Roos Instruments following the instructions below:

- Wrap the instrument in heavy paper or plastic. If the instrument is a circuit board, wrap it in anti-static material first, then add additional wrapping material. (If shipping to Roos Instruments for service, attach a tag indicating the service required, return address, model number, and full serial number).
- Use the provided shipping container as shown in [Figure 1.39](#).

- Insert the layer of shock-absorbing foam over the open side of the sides of the instrument as shown in [Figure 1.41](#), to provide firm cushioning and prevent movement inside the container.
- Seal shipping container securely. To close securely, DO NOT use masking tape, cellophane tape, duct tape, string, or paper over-wrap. Instead, use a strong tape such as pressure-sensitive plastic -- two inches (5.08 cm) or more in width, or nylon reinforced filament tape -- 60 lbs. (27 kg) grade tape at least three inches (7.62 cm) wide.
- Apply three strips to seal the open flaps of the box, where they meet in the center. If necessary, apply three strips of tape to the bottom of the box, so the middle and two edge seams are sealed.
- Mark shipping container “FRAGILE” to ensure careful handling.
- In any correspondence, refer to instrument by model number, serial number, and/or RMA number.

---

## PACKAGING AN RI7710/7725 SOURCE

The RI7710/7725 Source is considerably larger and more fragile than other Cassini instrument. As such, special care must be used when packaging for shipment. If at all possible, the source should be packaged in a Roos approved, Anritsu (OEM) shipping box. If shipping from North America, Roos Instruments will provide a box at request. When properly packaged in the appropriated Anritsu box, the

instrument is sandwiched between two plastic sheets, suspending it in the center of the box and provide adequate cushion against shock.

To package an Anritsu source, follow the instructions provided below:

- Wrap the instrument chassis in the conductive foam packing material provided. Be sure to complete encase the instrument, covering sharp edges and corners of the instrument chassis.
- Wrap the encased instrument with the provided plastic cover and tape the bag closed with standard clear packing tape.
- Place the wrapped instrument in the Anritsu box on top of the plasticized insert as seen in [Figure 1.42](#).
- Place the second plasticized insert on top of the wrapped source, and press it down firmly to sandwich the instrument between the inserts.
- Seal shipping container securely. To close securely, DO NOT use masking tape, cellophane tape, duct tape, string, or paper over-wrap. Instead, use a strong tape such as pressure-sensitive plastic -- two inches (5.08 cm) or more in width, or nylon reinforced filament tape -- 60 lbs. (27 kg) grade tape at least three inches (7.62 cm) wide.
- Apply three strips to seal the open flaps of the box, where they meet in the center. If necessary, apply three strips of tape to the bottom of the box, so the middle and two edge seams are sealed.
- Mark shipping container “FRAGILE” to ensure careful handling.



- In any correspondence, refer to instrument by model number, serial number, and/or RMA number.

---

## RECEIVING TIMS

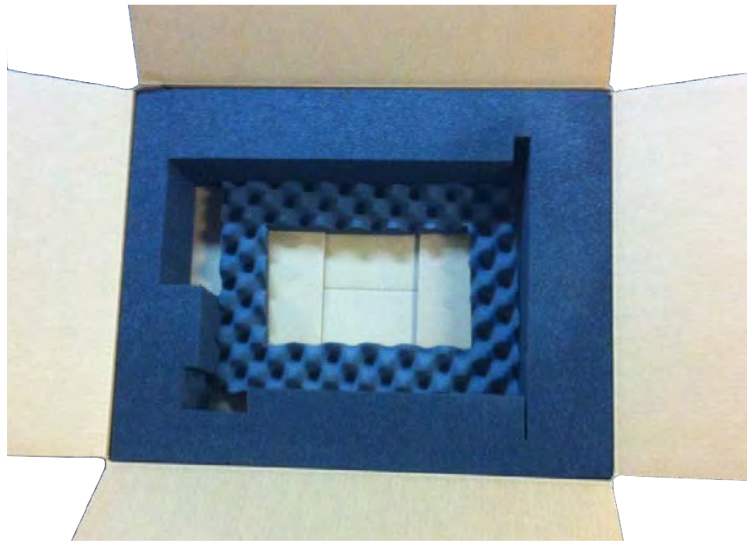
Once a TIM is returned from a factory or service repair, a visual inspection and validation of instrument functionality should be performed as soon as possible to insure that no shipping damage has occurred. If the TIM is not to be utilized immediately, it should be stored in the provided shipping packing and kept in a temperature controlled, static-free environment.

If the TIM has been upgraded or utilizes calibration data, there are several software resources that must be updated in Guru. Installing these software resources first will allow the TIM to download and utilize the updated resources automatically when inserted and powered up in the test system. A .gzip file containing the appropriate TIM firmware and cal data is provided by Roos Instruments via email. This .gzip file must be imported into the Cassini test system's Guru. This can be accomplished by using the Importer feature of Guru Browser on the local test system, or by importing the file into the networked Guru Server (via a Cassini VirtualBox simulator or Guru Client application) that services the associated Cassini test systems. Once this has been imported and is available on the test system, the TIM can be installed. If the TIM is installed before the software resources are updated, a system startup is required to force the installed TIM to download and recognize the updates and calibration

data. The following steps provide the recommended actions for receiving a TIM:

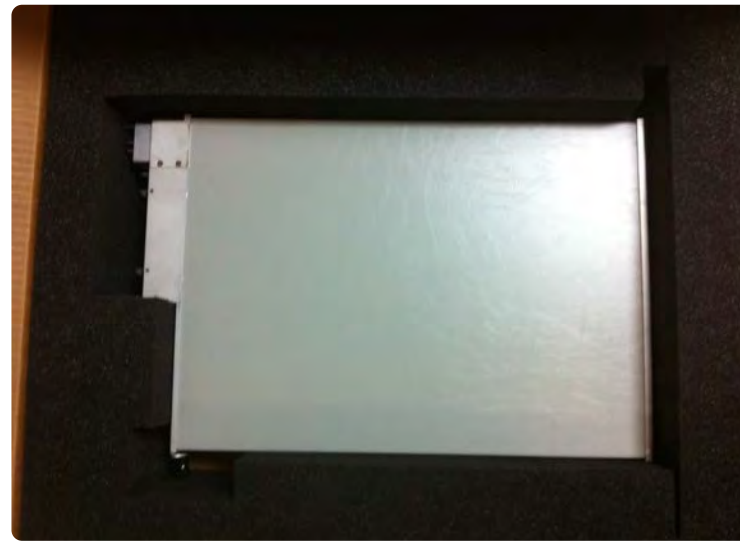
1. Verify the RMA number and information on the shipping container match the service documentation.
2. Inspect the cardboard TIM container for visible signs of shipping damage such as holes, cracks, and/or dents. If the shipping container appears to be significantly damaged, inform Roos Instruments immediately.
3. Remove the TIM from shipping container and visually inspect the chassis, latches, and instrument interface for any signs of shipping damage. If the TIM appears damaged or internal components appear loose, inform Roos Instruments immediately. DO NOT install a TIM that is suspected to be damaged into the test system. Contact a Roos Instruments service or support engineer.
4. If the TIM has been re-calibrated or upgraded at the factory, the TIM software resources must be updated in Guru. Reference the text above for more information.
5. If the TIM appears to be in good working order and software resources are up to date, it can be installed in the test system and powered up. Be sure to remove any fixture or diagnostic/calibration plates before installing the TIM.
6. Allow 20 minutes of warm-up time before performing TIM validations, calibration, or using the instrument.

FIGURE 1.39 RI PROVIDED TIM SHIPPING CONTAINER



The Roos Instruments TIM shipping shown above is designed for standard TIM transport. The container's dimensions are 26in x 20in x 8in (66cm x 51cm x 20cm). Conductive foam is shaped to conform to the TIM shape, providing ESD and impact shock protection.

FIGURE 1.40 TIM PLACEMENT IN SHIPPING CONTAINER



The TIM should be placed inside the shipping container as shown, orienting the instrument with its' associated conformal foam shape.

FIGURE 1.41 FOAM PLACEMENT IN SHIPPING CONTAINER



Place the included packing foam over the top of the TIM to encase the instrument within the container as shown.



FIGURE 1.42 RI7710/7725 SHIPPING CONTAINER



The shipping container for an Anritsu source suspends the source between within the container using a plasticized insert.

FIGURE 1.43 RI7710/7725 SHIPPING INSERT



After placing the Anritsu instrument in the shipping container, it is sandwiched by the plasticized insert shown above, suspending the instrument within the container and securing it in place.

# FIXTURES



## TOPICS

---

[General Information](#)

[Diagnostic & Calibration Interface Plates](#)

[Inserting & Removing](#)

[Shipping Requirements](#)

# OVERVIEW

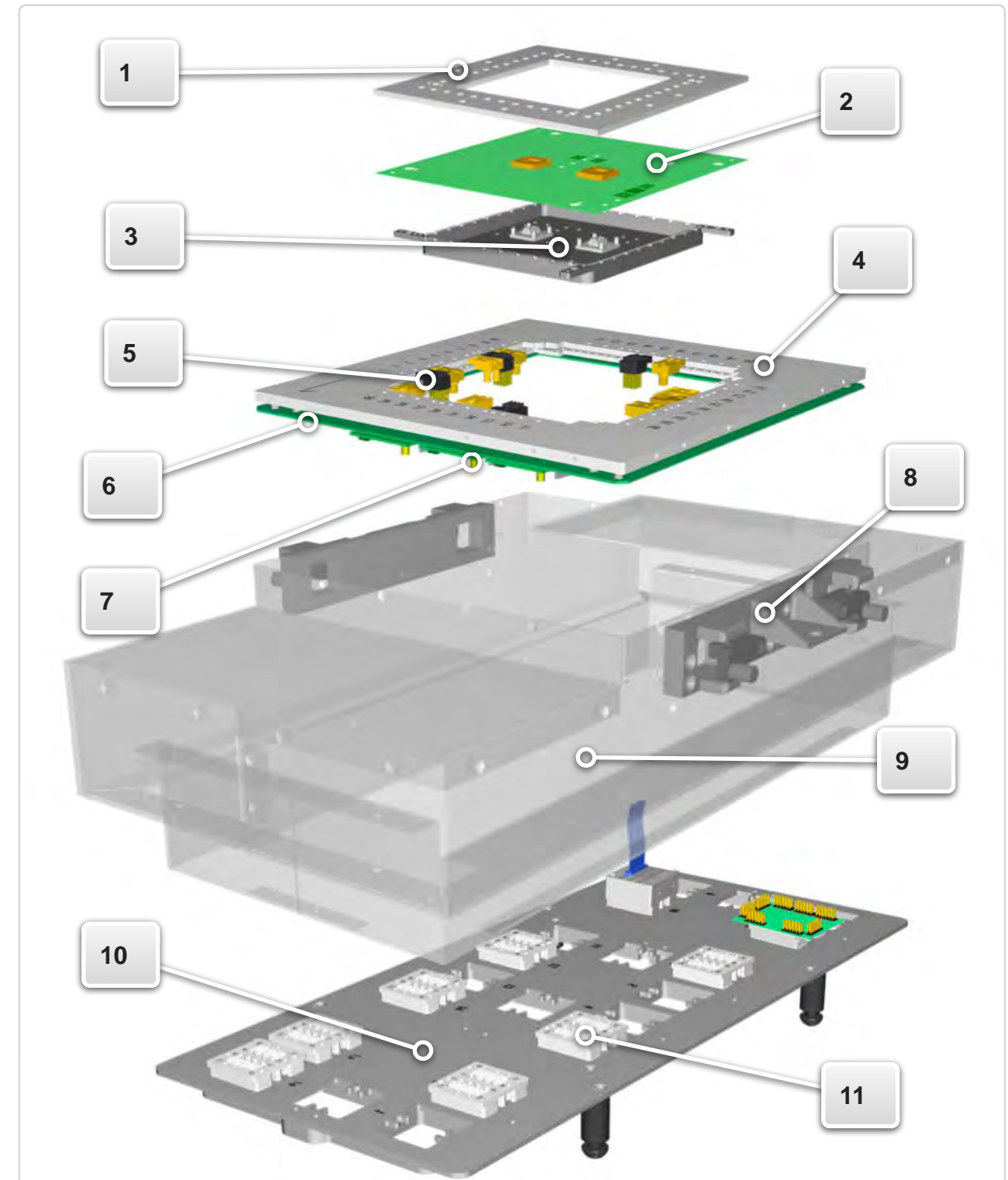
Cassini fixtures carry the modular architecture of Cassini into the device interface environment. Housed in a rugged aluminum enclosure is a completely configurable test resource environment. The form factor and discrete design layers support an application range from DC to 90GHz. Integration with Cassini's software allow fixtures to extend and enhance the capabilities of test instruments with an integrated calibration layer that delivers signal accuracy right to the device pin.

## COMPONENTS

All of the functionality and capability of traditional load boards have been re-engineered to take advantage of the configurable instrument framework of Cassini. The discrete layers shown in [Figure 1.44](#), enable design and development flexibility for high-performance RF devices that can be optimized independently to suite application needs. Listed below are the component names and definitions:

1. **Device Interface Board (DIB) Clamp** - One of three components comprising the Quick-Lock™ system, the DIB clamp aligns and protects the Device Interface PCB by sandwiching it between electrically shielded aluminum with a pliable conductive elastomer liner. The clamp frame design coupled with the pedestal support enhances multi-site RF signal isolation.
2. **Device Interface Board (DIB)** - With most of the application specific resources moved inside the fixture, the DIB consists of a

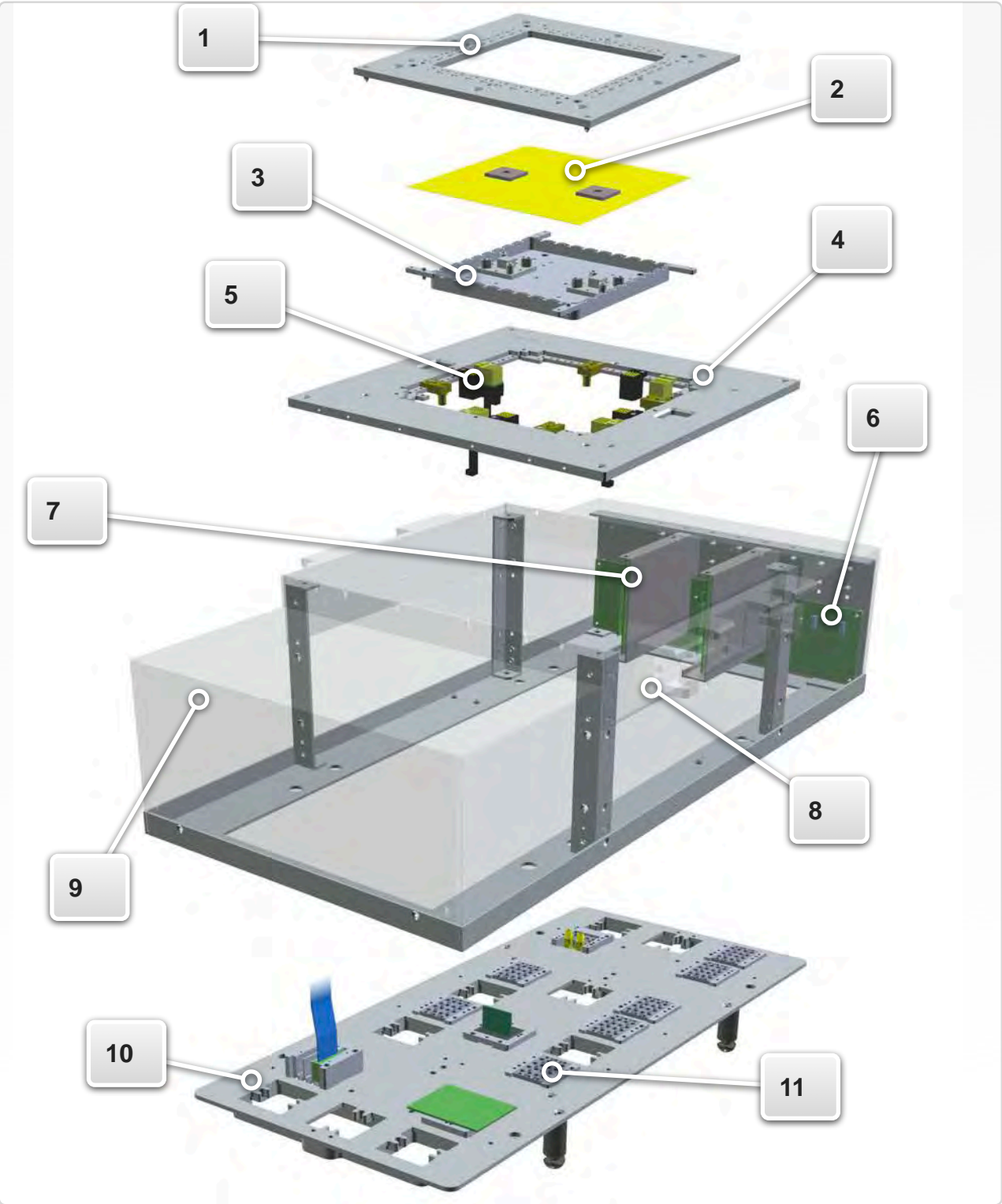
FIGURE 1.44 ANATOMY OF A MATRIX FIXTURE



- 2-layer PCB of interconnect with passive RF matching components. With a solid ground plane on top and strip line microwave signal paths, the DIB delivers unmatched performance up to 20GHz, providing a low-cost solution for a high-wear component.
3. **Pedestal Support & Pedestals** - The Pedestals and Pedestal Support completes the Quick-Lock™ system. Aluminum pedestals and pedestal support provide reinforcement of the socket sites from underneath the PCB during handler insertion. The support housing doubles as both protection of the PCB as well as providing RF shielding and enhancing site isolation for the socket sites with a pliable, conductive elastomer liner.
  4. **Top Plate** - The aluminum top plate frame incorporates a hinge top design for easy access to resources within the enclosure in addition to over 30 signal launch locations to support custom site topologies.
  5. **Signal Launches** - Standardized and interchangeable DC, high-speed digital, RF, and millimeter wave inserts provide high performance, precision signal launching around the perimeter of the device interface board. The launches incorporate spring loaded pogo pins for DC and digital signal interfaces with the PCB. RF signal launches utilize a unique pressure contact and RF launch tab design on the PCB. Several RF launch designs offer differential pair, enhanced matching, and frequency range options.
  6. **Fixture Carrier** - the matrix fixture carrier PCB, as shown in [Figure 1.44](#), provides 13 standard fixture module locations in addition to static control bits and  $\pm 5V$ ,  $\pm 15V$ , and  $+28V$  supply power distribution. The pod fixture PCB, as shown in [Figure 1.45](#), supports up to 8 pods with two module locations on each. Fixtures can be equipped with up to two pod carriers for a total of 16 pods/32 module locations. The carrier includes interfaces with Cassini's RIFL test head data bus to bring integrated software identification, control, and RF path calibration into the device interface environment.
  7. **Fixture Modules** - Standardized instrument resources to extend and enhance TIM capabilities such as: RF switches, DC/RF relays, signal conditioning, parametric measure, and more. These connect
  8. **Docking Ears** - part of the mechanical handler docking system with built-in mechanical dampening and compliance for a variety of handler setups.
  9. **Fixture Body** - The rugged aluminum enclosure provides protection of sensitive microwave components in addition to providing thermal and electrical shielding. The frame supports an integrated, precision handler docking system.
  10. **Bottom Plate** - an aluminum plate with 16 universal TIM interface slots and standard docking pins for interfacing with Cassini's test head. Each TIM slot accommodates standard TIM interface blocks with precision mechanical compliance.



FIGURE 1.45 ANATOMY OF A POD FIXTURE



11. **TIM Interface Blocks** - standard, blind-mate signal interface blocks for all of Cassini's test instrument modules. The blocks bring all of the TIM resources into the fixture's device interface environment.

# DIAGNOSTIC/CALIBRATION INTERFACE PLATES

Diagnostic and calibration plates are fixture design bottom plates, inserts and interconnect that are designed specifically for a test system configuration. The TIM interface blocks provide access to the various signal/path resources of microwave TIMs. Resources from different microwave TIMs are connected to other TIMs for routing signals for calibration or mimicking connections in an application fixture for custom or application specific calibration/diagnostic purposes. DC TIMs are connected specialized interface blocks for calibration and/or diagnostic purposes.

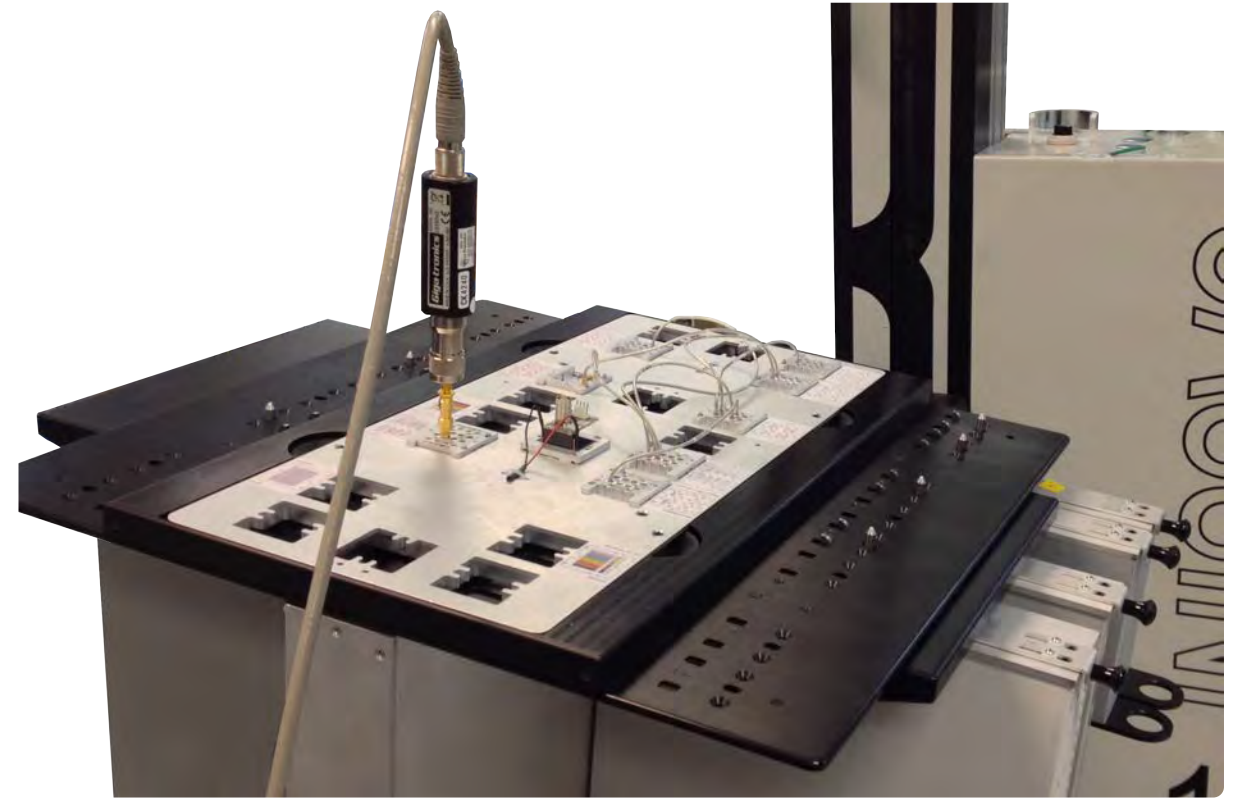
---

**CAUTION:** Always verify the test head TIM configuration matches the calibration/diagnostic plate interface block layout before docking to the test head. Keyed pins are designed to prevent mismatched TIM and interface block mating but unintentional damage can occur.

---

Every calibration/diagnostic plate is fitted with a serial ID chip located on the Fixture RIFL interface block. This serial ID matches the serial bar code sticker on the plate. The system software uses this ID chip to identify the plate when installed and automatically load the microwave signal path/interconnections. These software-defined interconnections and plate resources are needed to compile and execute diagnostics and calibrations of individual TIMs as well as the overall system.

FIGURE 1.46 CASSINI16 CALIBRATION PLATE EXAMPLE



The image above shows a Cassini16 system and calibration plate with an RF power sensor/meter inserted to calibrate a microwave TIM.



# INSERTING AND REMOVING FIXTURES

Fixtures and calibration/diagnostic plates are designed with test head docking fasteners, blind-mate TIM interface blocks, and alignment pins to make them easy to add and remove from the test system. These components provide easy access to test resources and require no teardown of the test setup when performing maintenance procedures on the tester. The methods for docking and undocking a fixture from the Cassini test systems are detailed in the following text.

## CASSINI 16

*NOTE: Always use a TIM-compatible 16 slot or 8 slot bottom plate/fixture when docking to a Cassini 16 test system.*

### TO DOCK A FIXTURE OR DIAGNOSTIC PLATE, FOLLOW THE STEPS BELOW:

1. Rotate the test head into the upright position and secure the rotation lock by putting it into the LOCKED position.
2. Position the manipulator arm into the MAINTENANCE POSITION using the locking latch found on top of the manipulator armature.

FIGURE 1.47 FIXTURE DOCKING INDICATOR LIGHTS



The docking indicator lights are located on the side of the test head nearest the infrastructure chassis. When the test head is powered up and active but no fixture or calibration/diagnostic plate is present both LEDs are red.

3. Insure that the TIM locations on the test head match the TIM interface blocks on the bottom plate of the fixture or calibration/diagnostic plate.

**CAUTION:** *Keyed pins on the TIMs and keyed receive openings on the TIM interface blocks are designed to prevent mismatched TIM/interface block mating but unintentional damage can occur if the layouts do not match when docking.*

4. Insure the docking rotary knob on the infrastructure is in the UNLATCHED position.
5. Verify that the test head is active and the docking system is operational by checking that both fixture docking LEDs (ALIGN and LOCK) on the side of the test head nearest the chassis are both red as shown in image 1 of [Figure 1.47](#).
6. Holding the fixture or calibration/diagnostic plate along the short edges of the fixture or bottom plate with the docking pins facing downward, orient the alignment arrow (found on the fixture top plate or the sticker on a calibration/diagnostic plate) to point at the infrastructure chassis. Bring the fixture or calibration/diagnostic plate straight down onto the test head, checking that the docking pins move freely into position within their receive ports and interface blocks comply with their corresponding TIM alignment pins. Verify that the fixture orientation and alignment is correct by checking that the ALIGNMENT LED is now green and the LOCK LED is red (as shown in image 2 of [Figure 1.47](#)).

*NOTE: The alignment must be correct, and ALIGN LED must be green to activate the pneumatic locking drive system.*

7. The bottom plate or fixture should sit level on the test head and be slightly above flush relative to the finger guard on the test head that surrounds the bottom plate.

8. Turn the docking rotary knob to the LATCH position. The pneumatic drive force will engage the docking canoes underneath the test head with the bottom plate docking pins, pulling the bottom plate down and flush across the finger guard.
9. Verify that the fixture has been successfully docked checking that the ALIGNMENT LED and the LOCK LED are now green (as shown in image 3 of [Figure 1.47](#)).
10. Perform a **System Check** to activate the fixture or calibration/diagnostic plate resources in the test system software.

---

*CAUTION: Always verify that both docking indicator lights are green before moving or rotating the test head to prevent accidental drop of the fixture or calibration/diagnostic plate.*

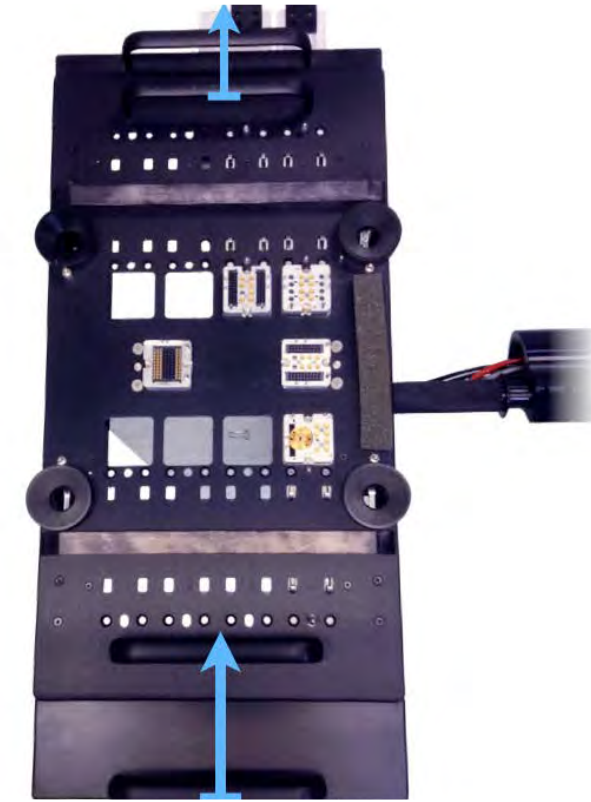
---

When docking the test system to a handler, typically the fixture is docked to the handler first, and then the test system is positioned underneath or adjacent to the handler/fixture by rotating the test head accordingly and using the rolling castors. Fine adjustment is achieved through the electromechanical lift and 2-axis planar/gimbal movement to dock the system to the fixture/handler. The docking indicator lights are used to visually verify alignment and successful dock.

## TO UNDOCK A FIXTURE OR DIAGNOSTIC PLATE:

1. Rotate the test head into the upright position and secure the rotation lock by putting it into the LOCKED position.
2. Position the manipulator arm into the MAINTENANCE POSITION using the locking latch found on top of the manipulator armature.
3. Turn the docking rotary knob on the infrastructure from the LATCH to the UNLATCH position.
4. Verify that the pneumatic lock disengages the docking canoes underneath the test head from the bottom plate docking pins by checking that the LOCK indicator light is now red. (The bottom plate should move away from the test head and slightly above flush across the finger guard on the test head.)
5. Remove the fixture or calibration/diagnostic plate from the test head by lifting upwards and away from the test head.
6. Perform a **System Check** to remove the fixture or calibration/diagnostic plate resources from the test system software.

FIGURE 1.48 CASSINI 8/RI7100C FIXTURE DOCKING HANDLES



Actuation movement for locking a fixture to the test head.

7. When undocking the test system from a handler, turn the rotary latching knob from the LATCH position to the UNLATCH position. The test system can be moved away from the handler/fixture using the fine adjustment electromechanical lift and 2-axis planar/gimbal movement to undock. The test head can then be rotated back to upright and the system can be moved away using the rolling castors. The docking indicator lights can be used to visually verify undocking. The fixture can then be undocked from the handler.

## LARGE CASSINI

*NOTE: Always use an 8 slot bottom plate/fixture when docking to a Large Cassini test system.*

### TO DOCK A FIXTURE OR DIAGNOSTIC PLATE:

1. Rotate the test head into the upright position and secure the rotation lock using the slide handle.
2. Position the manipulator arm for ease of access to the fixture and lock into place using the two rotary knobs on the armature.
3. Insure that the TIM locations on the test head match the TIM interface blocks on the bottom plate of the fixture or calibration/diagnostic plate.

*CAUTION: Keyed pins on the TIMs and keyed receive openings on the TIM interface blocks are designed to prevent mismatched TIM/interface block mating but unintentional damage can occur if the layouts do not match when docking.*

4. Holding the fixture or calibration/diagnostic plate along the perimeter of the fixture or perimeter of the bottom plate with the docking pins facing downward, orient the alignment arrow (found on the fixture top plate or the sticker on a calibration/diagnostic plate) to point at the instrument rack. Bring the fixture or calibration/diagnostic plate straight down onto the test head, checking that the docking pins move freely into position within

their receive ports and interface blocks comply with their corresponding TIM alignment pins.

5. The bottom plate or fixture should sit level on the test head and be slightly above flush relative to the finger guard on the test head that surrounds the bottom plate.
6. Depress the fixture lock release switch located on the side of the test head nearest to the instrument rack (reference [Figure 1.20](#) for location) and manually actuate the canoe locks using the hand grips on the test head as shown in image 1 of [Figure 1.48](#).

*NOTE: Depressing the solenoid release switch for an extended period of time (> 5-10 seconds) results in excess current through the switch. To prevent damage, the button has a built-in, cool down mode before reuse. The button will flash indicating the solenoid release is temporarily disabled during this cool-off period.*

7. The locking canoes will engage the fixture docking pins, pulling the bottom plate down and flush across the finger guard.
8. Perform a **System Check** to activate the fixture or calibration/diagnostic plate in the test system software.

### TO UNDOCK A FIXTURE OR DIAGNOSTIC PLATE:

1. Rotate the test head into the upright position and secure the rotation lock by putting it into the LOCKED position.



2. Position the manipulator arm for ease of access to the fixture and lock into place using the two rotary knobs on the armature.
3. Depress the fixture lock release switch located on the side of the test head nearest to the instrument rack (reference [Figure 1.20](#) for location) and manually actuate the canoe locks using the hand grips on the test head as shown in image 2 of [Figure 1.48](#).

*NOTE: Depressing the solenoid release switch for an extended period of time (> 5-10 seconds) results in excess current through the switch. To prevent damage, the button has a built-in, cool down mode before reuse. The button will flash indicating the solenoid release is temporarily disabled during this cool-off period.*

4. The locking canoes will engage the fixture docking pins, pulling the bottom plate down and flush across the finger guard.
5. Perform a **System Check** to remove the fixture or calibration/ diagnostic plate resources from the test system software.

## SMALL CASSINI

*NOTE: Always use an 8 slot bottom plate/fixture when docking to a Small Cassini test system.*

### TO DOCK A FIXTURE OR DIAGNOSTIC PLATE:

1. Rotate the test head into the upright position and secure the rotation lock using the slide handle.
2. Position the manipulator arm for ease of access to the fixture and lock into place using the two rotary knobs on the armature.
3. Insure that the TIM locations on the test head match the TIM interface blocks on the bottom plate of the fixture or calibration/ diagnostic plate.

*CAUTION: Keyed pins on the TIMs and keyed receive openings on the TIM interface blocks are designed to prevent mismatched TIM/interface block mating but unintentional damage can occur if the layouts do not match when docking.*

4. Holding the fixture or calibration/diagnostic plate along the perimeter of the fixture or perimeter of the bottom plate with the docking pins facing downward, orient the alignment arrow (found on the fixture top plate or the sticker on a calibration/diagnostic plate) to point at the instrument rack. Bring the fixture or calibration/diagnostic plate straight down onto the test head, checking that the docking pins move freely into position within

their receive ports and interface blocks comply with their corresponding TIM alignment pins.

5. The bottom plate or fixture should sit level on the test head and be slightly above flush relative to the finger guard on the test head that surrounds the bottom plate.
6. Depress the fixture lock release switch located on the side of the test head nearest to the instrument rack (reference [Figure 1.19](#) for location) and manually actuate the canoe locks using the hand grips on the test head as shown in image 1 of [Figure 1.48](#).

*NOTE: Depressing the solenoid release switch for an extended period of time (> 5-10 seconds) results in excess current through the switch. To prevent damage, the button has a built-in, cool down mode before reuse. The button will flash indicating the solenoid release is temporarily disabled during this cool-off period.*

7. The locking canoes will engage the fixture docking pins, pulling the bottom plate down and flush across the finger guard.
8. Perform a **System Check** to activate the fixture or calibration/ diagnostic plate in the test system software.

## TO UNDOCK A FIXTURE OR DIAGNOSTIC PLATE:

1. Rotate the test head into the upright position and secure the rotation lock by putting it into the LOCKED position.

2. Position the manipulator arm for ease of access to the fixture and lock into place using the two rotary knobs on the armature.
3. Depress the fixture lock release switch located on the side of the test head nearest to the instrument rack (reference [Figure 1.19](#) for location) and manually actuate the canoe locks using the hand grips on the test head as shown in image 2 of [Figure 1.48](#).

*NOTE: Depressing the solenoid release switch for an extended period of time (> 5-10 seconds) results in excess current through the switch. To prevent damage, the button has a built-in, cool down mode before reuse. The button will flash indicating the solenoid release is temporarily disabled during this cool-off period.*

4. The locking canoes will engage the fixture docking pins, pulling the bottom plate down and flush across the finger guard.
5. Perform a **System Check** to remove the fixture or calibration/ diagnostic plate resources from the test system software.



# SHIPPING REQUIREMENTS

Factory assembled fixtures are shipped inside a shipping container with a specially designed fixture storage crate. Fixtures should always be packaged and shipped using the Roos Instrument's provided container and storage crate. DO NOT discard these containers. They are designed specifically for the instruments and TIMs with adequate sizing, anti-static material, and conformal padding to protect them during transport. If this container and shipping material are not available, contact Roos Instruments for further instructions.

Damage to fixtures during shipping is the responsibility of the shipping party. Roos Instruments assumes liability for damage of equipment shipped from the factory. Roos Instruments is not liability for shipping damage of equipment shipped to Roos Instruments for service, repair, or otherwise.

---

## SERVICE INFORMATION

If a product is being returned to Roos Instruments for service, please provide enough information to help expedite repair and return of the product. For best service results, include as much information as possible: symptoms, date of failure, the current status of the instrument, etc.

Items for return must include a Return Merchandise Authorization (RMA) number. To obtain an RMA number, please email

[support@roos.com](mailto:support@roos.com) or contact Roos Instruments at 1.408.748.8589 between the hours of 9:00 a.m. to 6:00 p.m. (U.S. Pacific Standard Time)

An RMA must be requested within 15 calendar days of the invoice date (ship date for credit card orders). NO returns of any type will be accepted without an RMA number and ALL returns must be shipped prepaid and insured via any common carrier (i.e. UPS, FedEx). Tracking information is required.

---

## PACKAGING A FIXTURE

Proper packaging of fixtures prevents damage and improves response time for repair and replacement. Every fixture should be individually boxed with the supplied shipping container, storage crate, and packaging provided by Roos Instruments following the instructions below:

The fixture should be placed inside the provided shipping containers. If not available, the fixture should be shipped in a container with the following specifications:

- Single Wall Corrugated
- Bursting Test: 200 lb./sq. inch
- Min Comb WT Facings: 84 lbs per m sq. ft
- Size Limit: 75 inches
- Gross Weight Limit: 65 pounds
- Min Dimensions: 20"x20"x12"

The box used should allow for at least 3 inches of isolation between the fixture and box walls (not including the thickness of the bubble wrap).

Avoid placing styrofoam or packaging material in and around interface pins and ports as well as the interior of the fixture as this may damage connectors, cables, etc.

# HANDLER AND PROBER INTERFACING

This section provides the procedures and recommended best practices for interfacing a Cassini 16 test system with a Handler or Prober. Reference the [Site Preparation for Cassini Test Systems](#) section in the System Information chapter for test floor compliance of environmental, electrical, and equipment requirements. Users should always adhere to the safety guidelines provided in the [Operator and Safety Information](#) section in the System Information chapter.

## OVERVIEW

The Cassini test system was designed to enable a single user to interface and dock the tester to a handler or prober. The process breaks down into four main steps:

1. Connect the common or ground between the test system and handler or prober.
2. Mount the fixture to the handler or prober.
3. Position and dock the test system to the mounted fixture.

4. Connect the communication pod from the test system to the handler/prober.

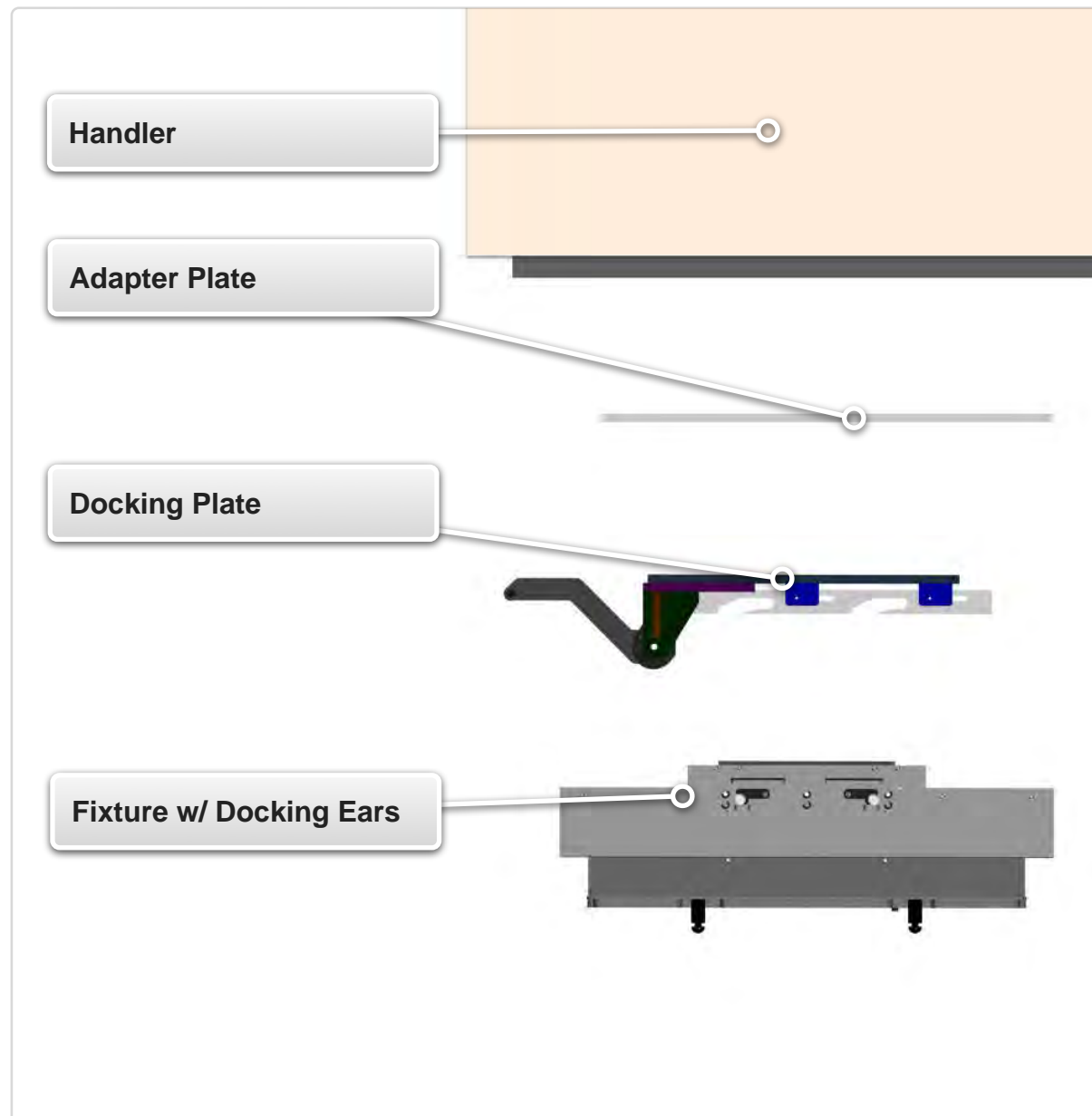
The components necessary to mount the test fixture to a handler are provided in [Interactive 1.1](#). The handler's backplane is outfitted with an adapter that provides the thru mount threaded holes for mounting the adapter plate to the backplane and the docking plate to the adapter plate. The docking plate provides a manual actuating lever that docks the Cassini fixture to the handler. Four shoulder rails on the docking plate engage the 4 cams on the fixture's docking ears. These cams provide ~128 pounds of z-force pressure to align and secure the fixture to the handler with a high degree of z-height precision.

*NOTE: The z-height can be adjusted to comply with handler manufacturer specifications. Contact [support@roos.com](mailto:support@roos.com) for more information.*

With the fixture attached to the handler, the test system can be positioned and docked to the fixture using the rolling castors on the infrastructure, see [Figure 1.49](#). This method enables the use of the blind-mate TIM interfacing system on Cassini for more consistent and reliable docking compliance as shown in [Figure 1.50](#). Reference the [Infrastructure Section](#) for more information on the test head manipulator and the [Cassini 16 infrastructure diagrams](#) in the appendix for mechanical compliance. After the test system is docked to the handler, the handler/prober communication pod can be connected. The handler or prober pod is pre-programmed for a

specific model and configuration of Handler or Prober. Additional [Configuration Instructions](#) are available [online](#).

### INTERACTIVE 1.1 HANDLER DOCKING COMPONENTS (TOP VIEW)



### CONNECTING TO HANDLER OR PROBER:

Reference the [Cassini 16 Infrastructure Diagram](#) for component names and locations. The test system can be powered on with TIMs installed when connecting to a handler or prober.

1. The system should be installed following the instructions provided in the [Installation section](#) and powered-on following the instructions provided in the [System Startup Procedures](#).
2. Position the Cassini test system adjacent to the Handler or Prober in preparation for attaching the grounding cable.
3. Attach the green grounding cable with alligator clip from the Infrastructure (see [Figure 1.51](#)) to a grounding point on the Handler/Prober indicated by a post or mounting point with the ISO ground symbol  $\perp$ . If an auxiliary rack is present, an additional green grounding wire should be connected from the auxiliary rack to either the test system's infrastructure ground or the Handler/Prober ground.

**A grounding cable is required to maintain a common voltage ground between the handler or prober and the test system to prevent ESD. Handler communication issues and/or DUT failures can occur if the green ground cable is not properly connected.**

*NOTE: The alligator clip can be removed from the ring connector when attaching the grounding cable with a fastening screw.*

4. Dock the fixture (equipped with docking ears) to the handler or prober using the manually actuating docking plate.
5. Rotate and lock the test head into the docking orientation (test head facing the handler/prober with the attached fixture). Verify that the orientation of the fixture matches with the test head, checking that corresponding TIM block inserts in the fixture match the test head TIM layout before continuing. See the [Infrastructure](#) section and/or [Appendix](#) for more on the test head articulation operation and mechanical compliance.

---

**WARNING: Always lock the test head rotation pin after any test head positioning to prevent accidental rotation that could cause injury to persons or damage to the test head manipulator's internal components.**

---

6. Attach the GPIB, parallel, or serial cable from the Handler or Prober to the communication pod (see [Figure 1.52](#)).

*NOTE: This cable must be provided by the facility and should be assembled according to Handler or Prober manufacturer's specifications.*

7. Attach the RIFL3-RIFL2 cable to any of the Infrastructure's available [RIFL H-Ports](#) and to the Handler Pod or Prober Pod (See [Figure 1.53](#)).

*NOTE: The Handler Pod or Prober Pod is pre-programmed for the intended Handler or Prober manufacturer model and interface type.*

8. Perform a [System Check](#). This will identify the connected pod and add it to the system configuration.

*NOTE: The pod will not appear in the instrument list of the Configuration Window. The pod can be viewed from the [Equipment Pool](#) window at the attached H-Port location.*

9. Release the test head manipulator lock pin (reference [Figure 1.17](#)) and move the test head so that the test head indicator dot is in the 'Docking Position,' allowing for fine planar adjustment of the test head.
10. Use the manipulator arm elevation control buttons to align the fixture docking ports with the fixture docking feet.

---

**WARNING: Insure that the fixture docking switch on the infrastructure is in the 'UNLATCH' position before continuing to the next steps. Failure to do so could result in injury to personnel or damage to the TIMs, test head, and/or fixture.**

---

11. Position the test system using either the elevation control (vertical docking) or the rolling castors (horizontal docking) so that the fixture docking feet slide into the test head fixture docking ports.
12. Verify that the 'ALIGN' LED on the test head is green, indicating that the fixture is properly aligned with test head before proceeding. Reference the [fixture docking](#) section for more information.



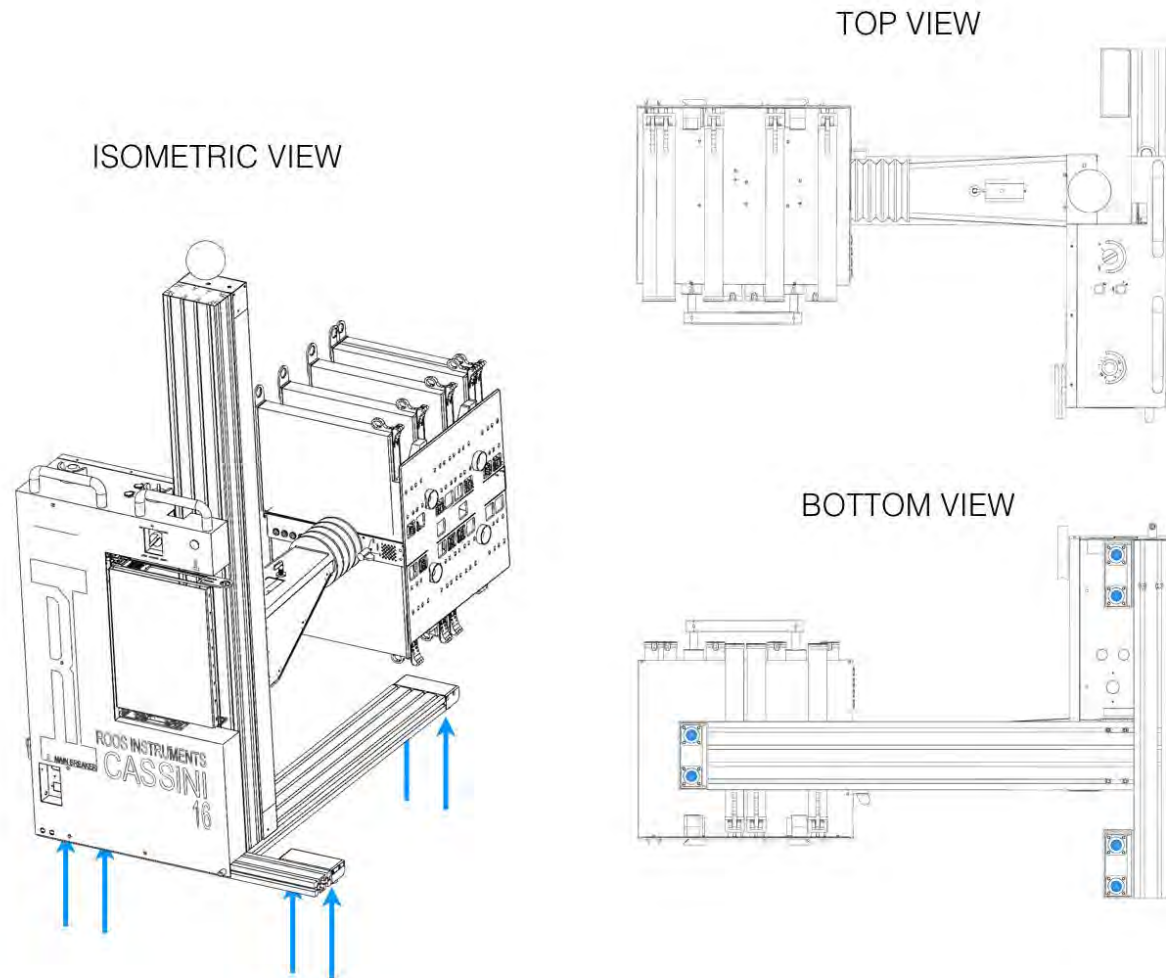
13. Engage the fixture docking pins by turning the fixture docking switch to the 'LATCH' position.
14. Verify that the 'LOCK' LED on the test head now is green, indicating that the test system has successfully docked to the fixture. Reference the [Inserting and Removing Fixture](#) section.

### **DISCONNECTING FROM HANDLER OR PROBER:**

It is recommended to permanently secure the Handler Pod, RIFL3-RIFL2 cable, and the GPIB, parallel, or serial cable directly to the Handler or Prober.

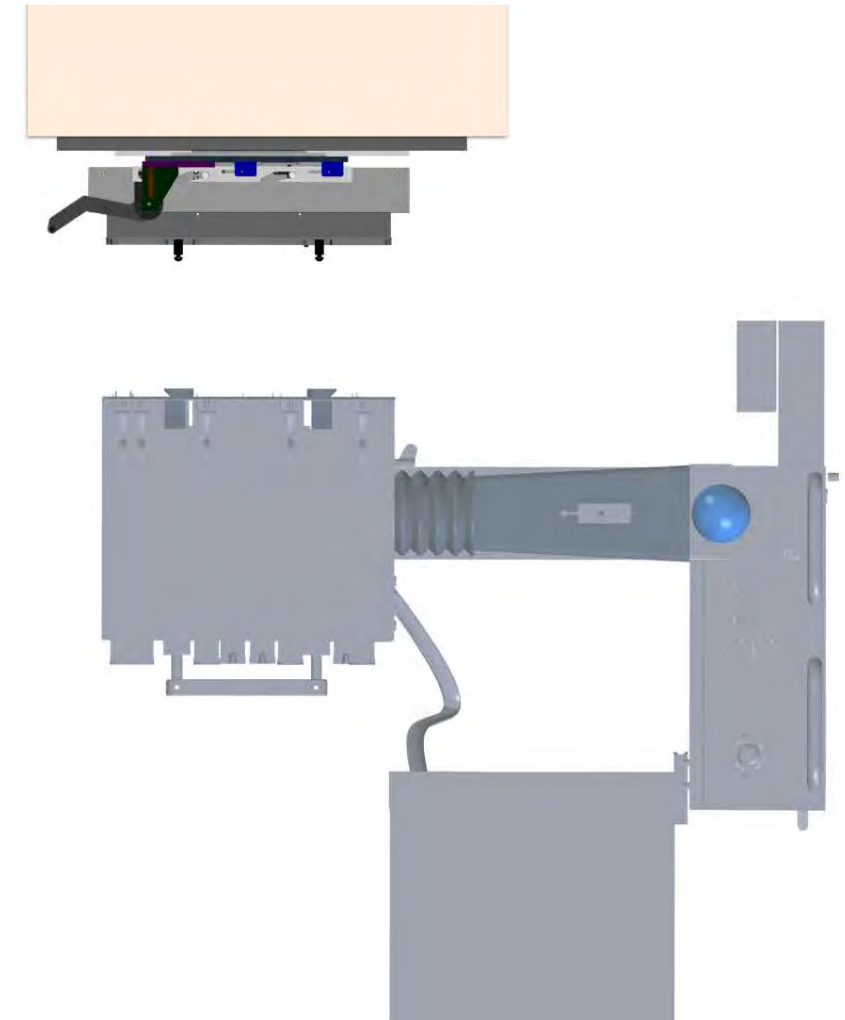
1. Undock the test head from the fixture following the instructions provided in the [Inserting and Removing Fixture](#) section.
2. Rotate and lock the test head into the upright orientation and lower the manipulator arm elevation so that the test head TIM interface can be viewed/accessed.
3. Place the test head manipulator lock pin into the lock position and using the test head position indicator into 'Maintenance Position' to lock the planar test head movement.
4. Detach the RIFL3 cable from the test head [RIFL H-Port](#) and secure the Pod and cables to the Handler or Prober.
5. Perform a [System Check](#) to remove the handler/prober pod from the test system configuration. Verify that the pod is no longer in the configuration by checking that the resource has been removed from the [Equipment Pool](#).

FIGURE 1.49 INFRASTRUCTURE POSITIONING



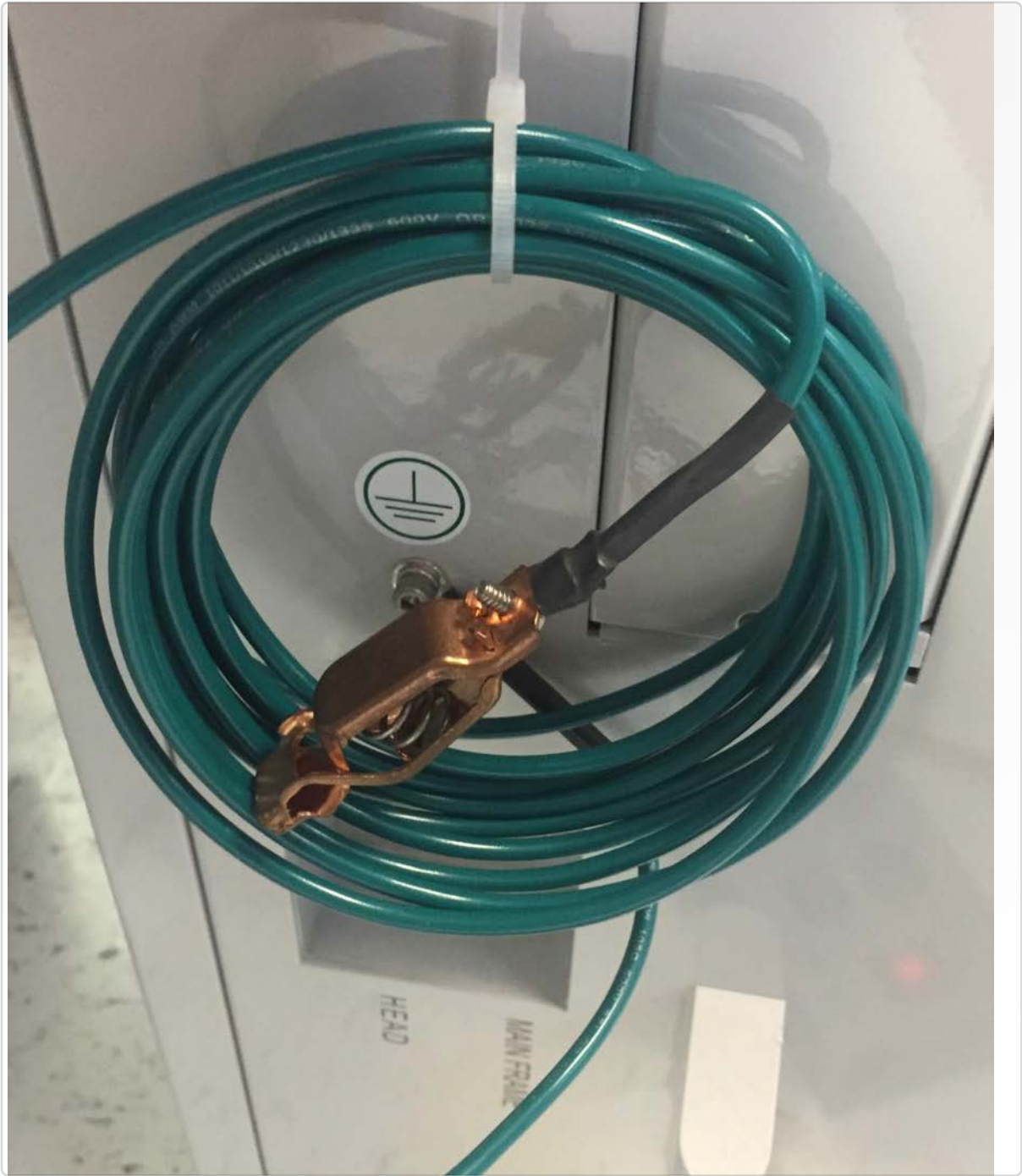
Six rolling castors on the underside of the infrastructure allow for positioning of the test system using the two hand bars located on the top of the chassis.

FIGURE 1.50 DOCKING CASSINI 16 TO A HANDLER (TOP VIEW)



With the fixture secured by the docking plate to the handler, the Cassini test system can be positioned with the rolling castors and docked using the fine planar movement of the test head and the blind mate TIM interface.

FIGURE 1.51 GROUNDING CABLE



The green grounding cable from the Infrastructure must be connected to a grounding mount on the Handler or Prober.

FIGURE 1.52 GPIB HANDLER OR PROBER POD (RI8552B)



The Handler/Prober Pod provides a GPIB, Parallel, or Serial connector conversion to RIFL2 and pre-programmed communication translation from the Handler or Prober type to Cassini. The RIFL2 connector attaches to Cassini with the included RIFL3-RIFL2 cable.

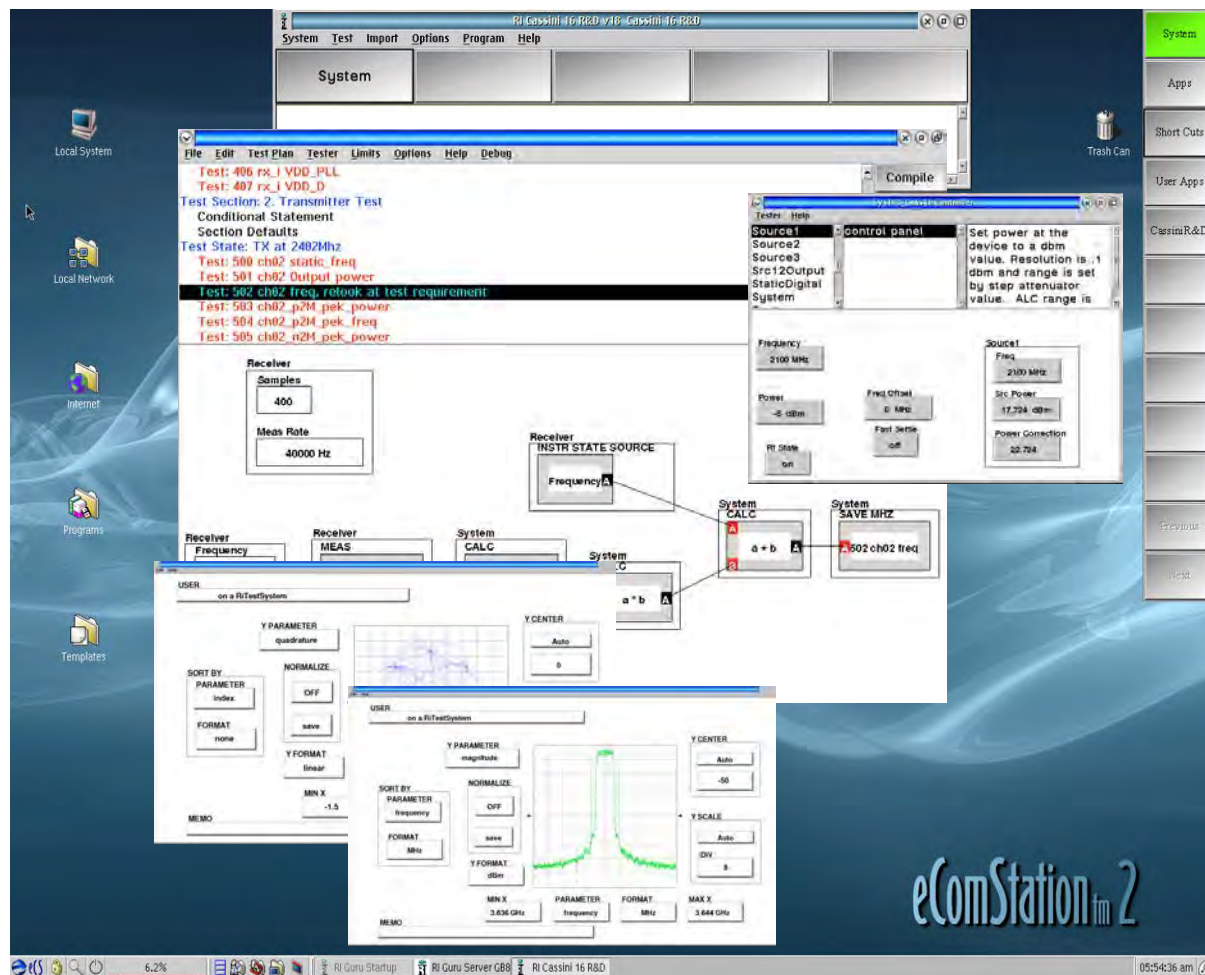
FIGURE 1.53 RIFL3 TO RIFL2 CABLE



The cable provides a conversion from a RIFL2 connector (Shielded RJ45) that plugs into the Handler/Prober Pod and a RIFL3 plug that connects to the RIFL H-Ports on the side of the Cassini test head.



# SOFTWARE ENVIRONMENT & TOOLS



## TOPICS

[Operating System](#)

[User Interface Control](#)

[Shortcuts & Software Patches](#)

[Main System Window](#)

[Message Window](#)

[Tester Configuration](#)

[Edit Panel](#)

[Control Panel](#)

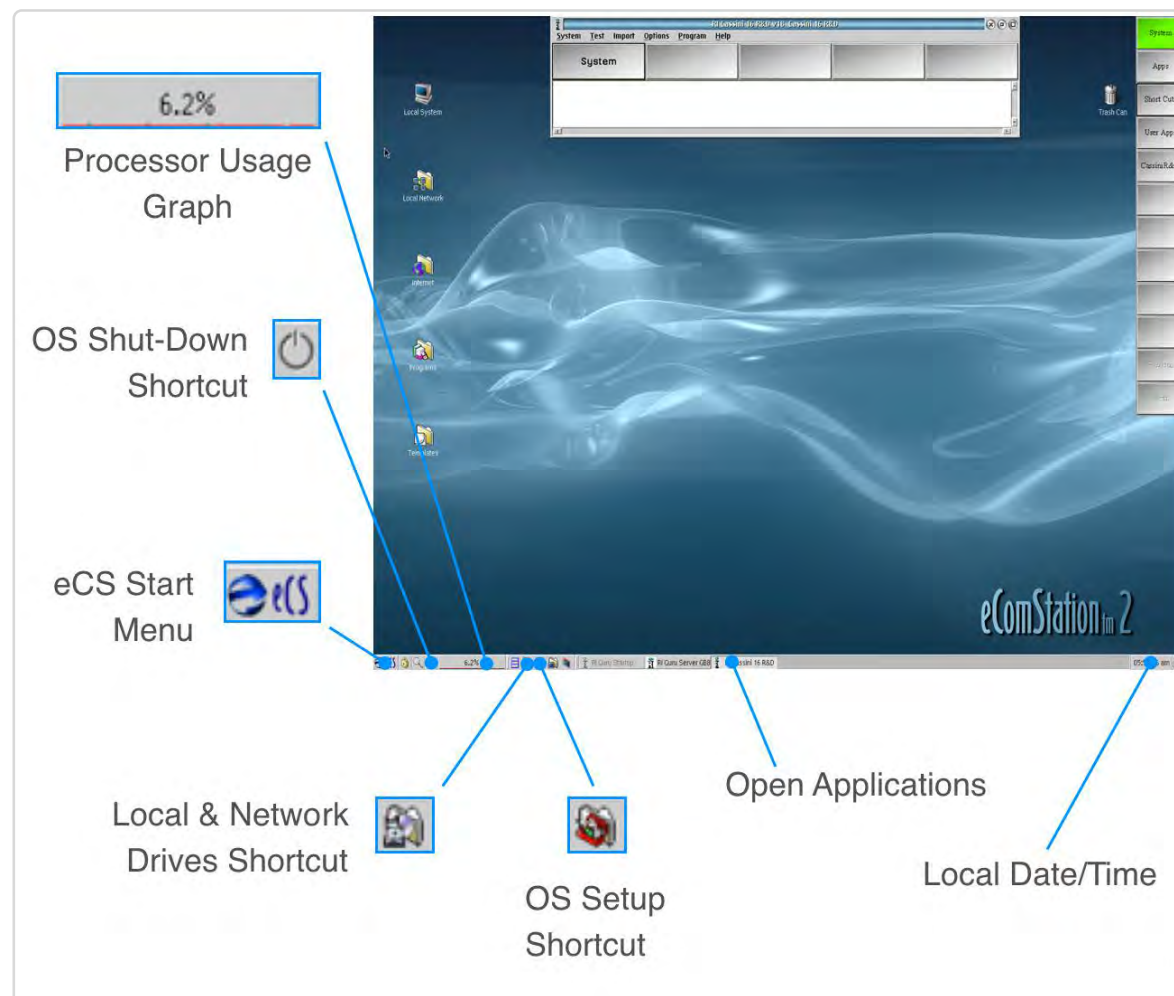
[Equipment Pool](#)



# OPERATING SYSTEM

Cassini's software uses the an OS/2 based operating system, either ArcaOS or eComStation (eCS). With its' combination of stability, reliable performance, and relatively small memory footprint, ArcaOS provides features and controls in parity with operating systems such as Linux, UNIX, and Windows based systems. While majority of test

FIGURE 1.54 FEATURES OF THE ECS OPERATING SYSTEM



operations are executed through the Cassini test system environment, some useful features of the OS are shown below for reference.

In [Figure 1.54](#), several useful shortcuts and features are depicted:

- **Processor Usage Graph** - displays a real-time line graph and percentage value of the current system processor usage. This tool is useful for determining the usage of current and background applications running on the test system.
- **OS Shutdown Shortcut** - provides a single button function for accessing the shutdown window of the operating system. This is typically used for a complete system shutdown after the Cassini test system software has been shutdown.
- **Start Menu** - provides a central launching point for OS utilities and third party applications. Applications such as the screenshot capture tool PMCamera can be accessed through the Start Menu.
- **Local & Network Drives** - provides a pop-up list of local and network attached drives. A left-button click on a drive in the list shows subdirectories and files. A right-button click opens a subdirectory view within a window with various file and directory hierarchical views.
- **System Setup** - provides single button access to the various operating system setups and preferences in a pop-up list view. A left click on the list opens the selected setup applications, and a right-button click opens the applications within a window.

- **Open Applications** - open application windows are displayed along the operating system task bar along the bottom of the screen. Left-clicking on a tab will make the selected application window active and highlight it's associated tab along the bottom. Background applications are displayed in the order they were launched. Right-clicking a tab provides an options pop-up list. Open applications can be browsed quickly by using the keyboard shortcut of holding down the Shift key and pressing the Tab key to switch between them. As well, clicking both the left and right mouse button anywhere on the background will open a list view of all open windows.
- **Local Date/Time** - the local date and time of the system is displayed in the lower right-hand corner of the screen. This date and time are used by the test system for local timestamp of files and data created and managed in Guru.

# CASSINI TEST SYSTEM ENVIRONMENT

The Cassini test system software is accessible through the login sidebar button found on the right side of the screen. This environment is designed specifically for managing the various resources of the Cassini ATE system.

## NETWORK CONNECTIVITY

The Cassini system uses a networked file management system called Guru (more information provided in the [Guru section](#)). The Logon/System button is color-coded to represent the test system's Guru network connection status. This color-coding updates in real-time to provide the user with a visual cue of the test system's network status. See Guru section for more information.

---

## USER INTERFACE CONTROL

The log-in environment enables access control and provides specific software user-interface environments tailored for engineers, service and support technicians, and test operators. User interface, software application, and file directory access control can be customized for individual users, groups of users, and customer sites.

## SERVICE & SUPPORT TECHNICIANS

Service and support technicians have user-defined access to tester features and functionality that can be tailored to customer specifications. Typically these users have access to essential software tools, functions, and files to perform tester general maintenance and diagnostic procedures in support of the test equipment. The tools typically include:

- Equipment Pool
- System Configuration Window & Control Panel
- Guru Applications: Importer/Exporter/Browser/Address Book
- Diagnostic Plans & Data
- Calibration Plans & Data

## ENGINEERS & TEST DEVELOPERS

Engineers and test developers have wide access to all the design and development tools for device, device interface, and test plan development tools as well as the file database directory on the Cassini ATE system.

## TEST FLOOR OPERATORS

A simplified touch screen user interface is deployed for test floor operators that can be customized to sites and users. An example of the UI for operators is provided below. The touch screen user controls

are limited to pre-approved test plan execution and essential tester functionality, i.e - test start/stop/pause/re-test, etc. Access to the underlying files, file directories and test development environment is prohibited by the UI.

## SHORTCUTS & SOFTWARE PATCHES

Shortcuts are predefined test environment packages that define the Cassini test system environmental and operational software update versions. These settings are typically customized to company parameters and/or site and include:

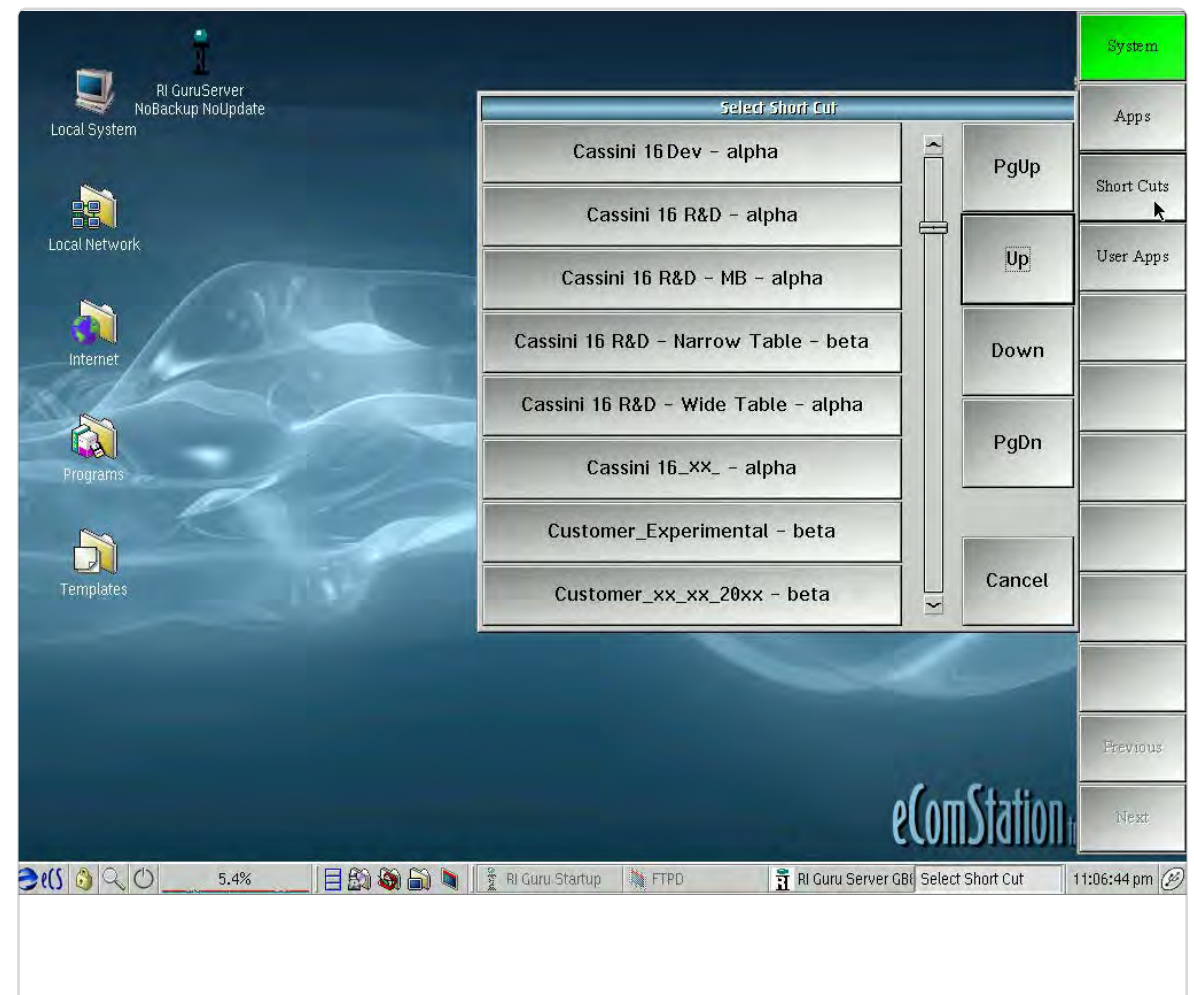
- User interface versions and settings
- Test software and instrument updates, drivers, and firmware patches

Shortcuts are typically provided by Roos Instruments as locked shortcuts. Locking a shortcut sets the current environment settings and software patches into a fixed set that cannot be altered. A system running a locked shortcut configuration will not receive software updates or patches. Updates and features are provided in new/released shortcuts.

*NOTE: Only one shortcut can be active at time. To launch a different shortcut, the user must first close Cassini application before launching a new shortcut.*

Shortcuts can be accessed by the Short Cuts button found on the right side of the screen after logging into the tester, see [Figure 1.55](#). Scroll the list by Left-clicking on the PgUp/Up or Down/PgDn buttons to move up or down the list. To launch the shortcut, left click on the button of choice from the list. Once a shortcut is selected, the main system window will launch and appear at the top portion of the screen. The name of the launched shortcut is displayed across the top of the main system window's menu bar.

FIGURE 1.55 OPENING A SHORTCUT





## CLOSING A SHORTCUT

Before closing a shortcut, always save and close all other applications and windows. To close the shortcut, left-click on the 'x' button found at the top right corner of the main system window menu bar. A pop-up window will prompt the user to confirm closing the shortcut. Selecting "Yes" will close the shortcut. Another option is to select the System menu option, and then select 'Quit' from the drop-down menu list. A pop-up window will prompt the user to confirm closing the shortcut.

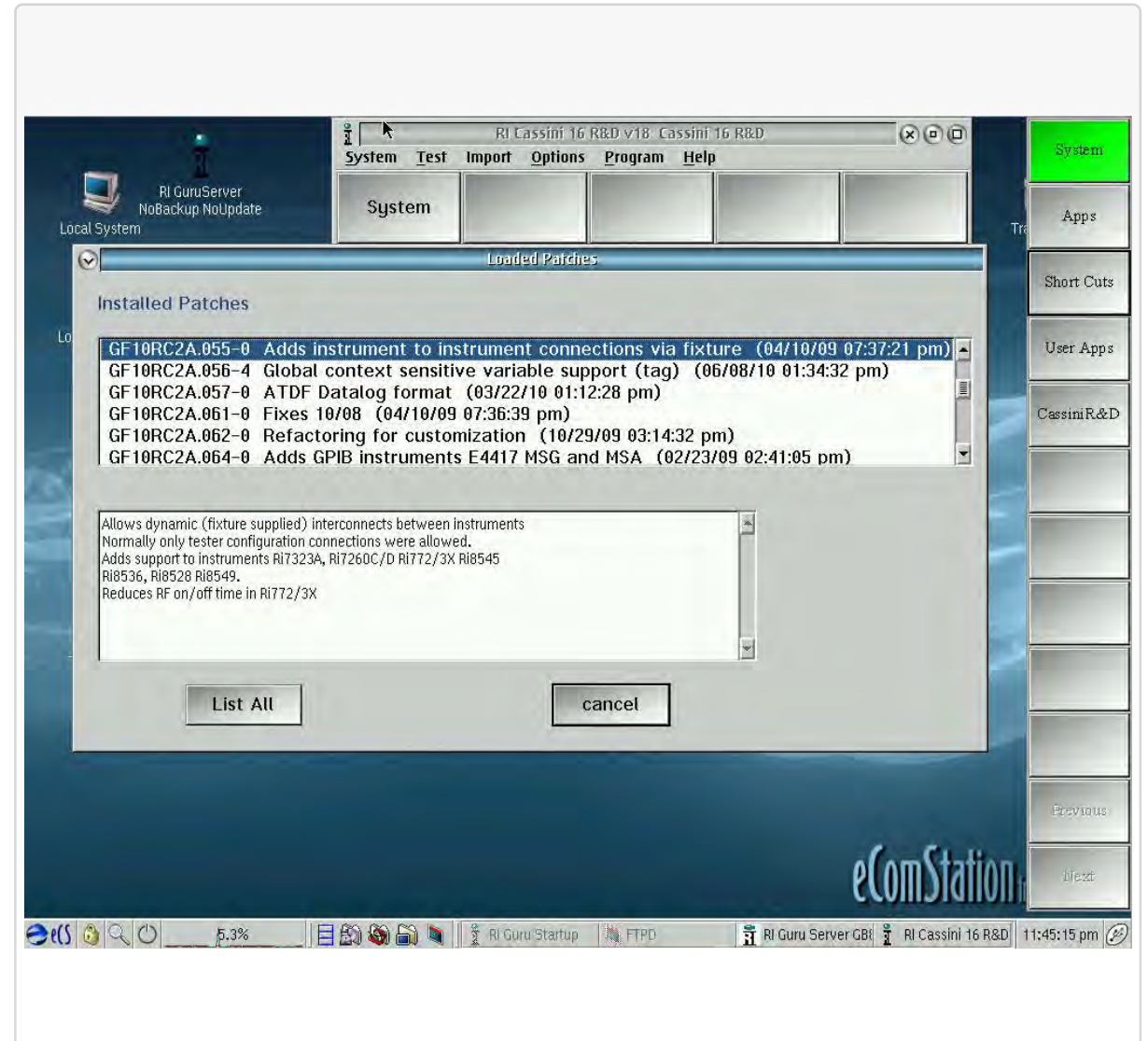
*NOTE: To launch a different shortcut, the user must logoff of the currently active shortcut.*

## SOFTWARE UPDATES

Software patches provide updates, improvements, new features, and software updates for the Cassini test system. Roos Instruments releases software patches on a regularly basis, and there are several ways to view them.

To view the list of patches that are currently loaded, select the 'Options' menu from the main system window, and then select the 'Show patches...' option from the list. This opens a 'Loaded Patches' window as shown in [Figure 1.56](#). Loaded software patches are listed in the top pane of this window with the bottom pane providing a description of the patch. Patches are listed from oldest to latest from top to bottom. The patches in the top pane show an alphanumeric ID

FIGURE 1.56 VIEWING SOFTWARE PATCHES: OPTION 1

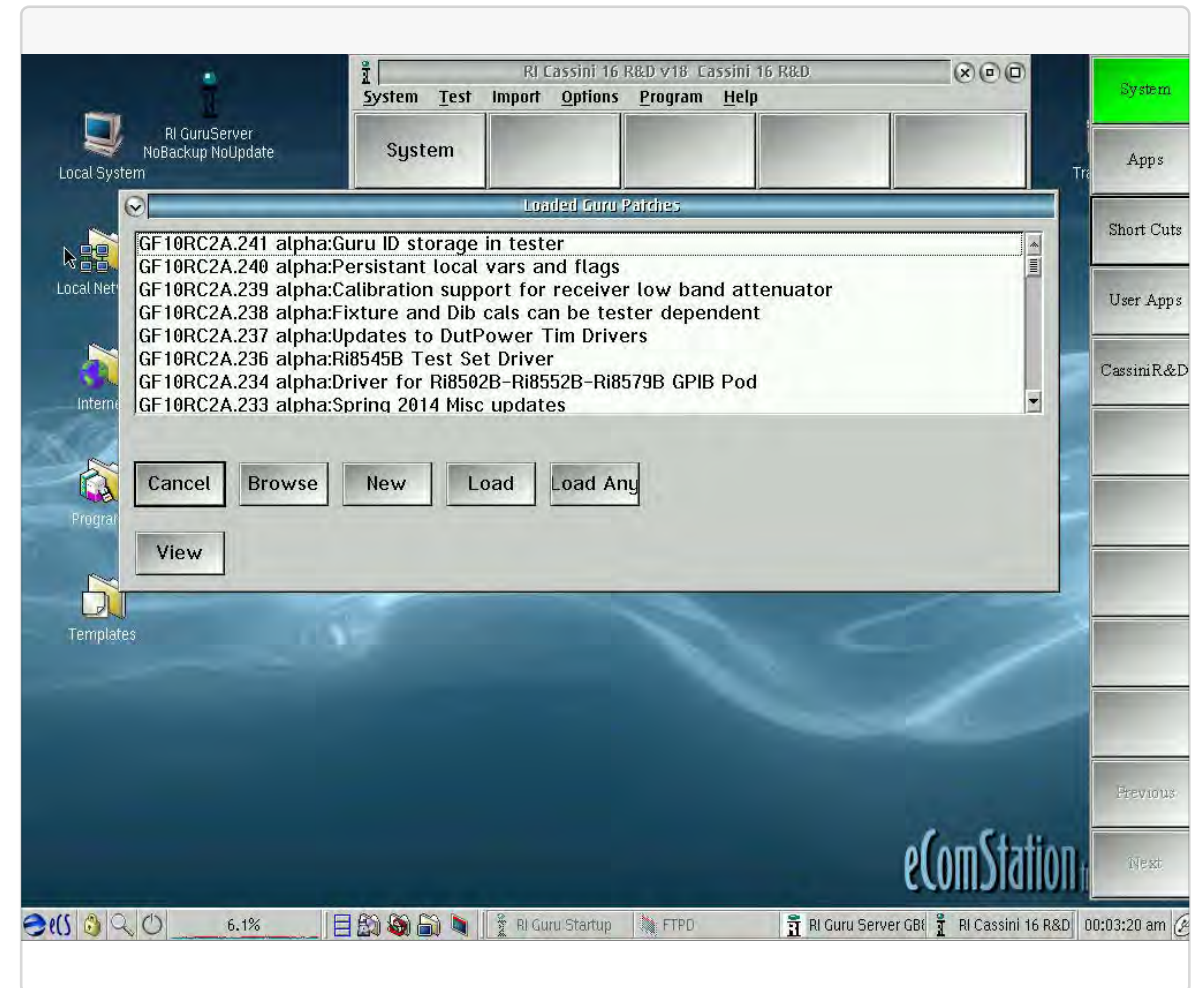


The Loaded Patches window is accessed through the **Options > Show patches...** menu selections in the main system window. The selected patch belongs to 'GF10RC2A,' which is the ID of the application that will be updated, with patch designation 055, subversion 0. It was created on April 10, 2009 and includes a description of the patch features in the lower pane.



that matches the patch with the application it updates. Following the decimal point is a three unit patch number. This designator number is the commonly referenced name of the patch. Following the patch number and '-' character is the patch subversion. Newer versions of the patch/update are defined by an increment of subversion number. Another option for viewing software updates is accessed by selecting the 'Program' menu of the main system window, and then selecting 'Guru Patch...' from the drop-down list. This option, shown in [Figure 1.57](#), opens a 'Loaded Guru Patches' window with several more options. Loaded updates/patches are displayed in the top pane of the window in order of descending patch number beginning with the highest patch number at the top of the list. As with the other patch viewing option, the alphanumeric designator of the patch's application is listed, followed by the three digit patch number. This is followed by the release version and a brief description of the patch. To view a list of all loaded patches in a text view, the user can select the View button below the list pane. This is useful for saving, emailing, or printing the list of loaded patches on the tester. Additional patches can be loaded by selecting the Load button and choosing from the available list in the pop-up window. The other button selections are reserved for Roos Instruments internal purposes only.

FIGURE 1.57 VIEWING SOFTWARE PATCHES: OPTION 2

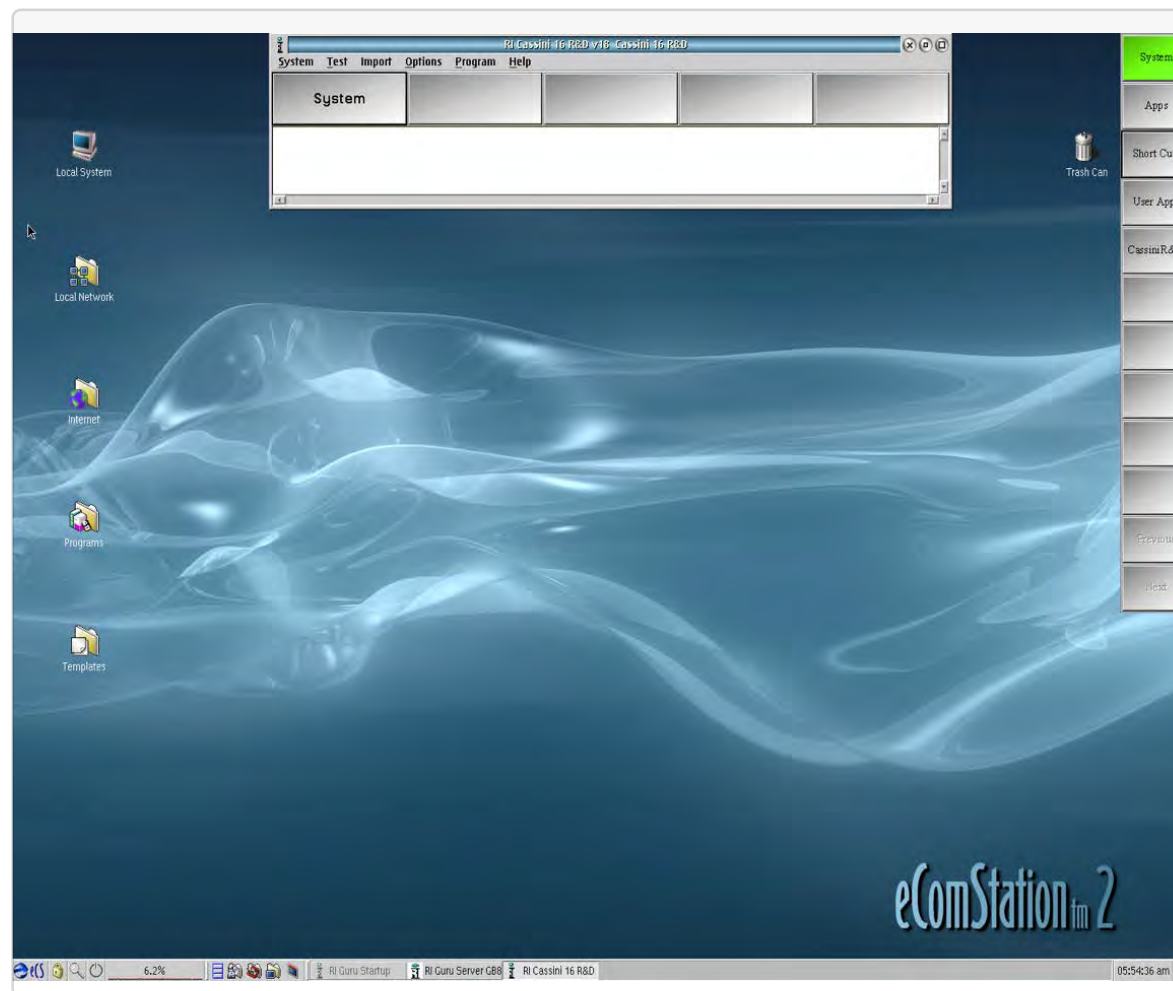


The Loaded Guru Patches window is accessed through the **Program > Guru Patch...** menu selections in the main system window. This option offers additional features such as browsing and loading additional patches, and viewing all patches in a text list for saving, email, or printing.

## MAIN SYSTEM WINDOW

The main system window is the central point for control and configuration information of the Cassini test system. The window launches automatically once a shortcut is selected and can be used as a quick visual verification that the tester is logged into a user and is running a software shortcut. The main system window provides

FIGURE 1.58 MAIN SYSTEM WINDOW



access to the Equipment Pool window, Tester Configuration window and System Messages window along with providing instant instrument control features through the Controller window and performing system checks and system startup functions.

## SYSTEM CHECK

The system check function is used to update the status of the Cassini test head configuration. Performing a system check requests the tester to refresh the status of connected instruments, fixtures, and peripheral hardware on the test head by way of the Roos Instruments Fast Link (RIFL) bus. In the case of added TIMs, the system check will verify the instruments identity, its location on the test head, provide 48V power to activate it, assign a serial number and RIFL address, and then add its' instrument functions to the list of available controls in the Control and Edit Panels. In the case of a TIM or fixture being removed from the tester, the system check will relinquish the test head slot, serial number, and RIFL address back to the software as an open slot and remove that instrument's function from the list of available instrument functions in the Control and Edit panels. In the case of an instrument that has remained in the system before and after the system check, the software does not make any changes. Whenever a test instrument module (TIM), fixture or diagnostic/calibration plate, or auxiliary instrument (by way of a RIFL/GPIB pod) is added or removed from the test head, a system check function should be performed.

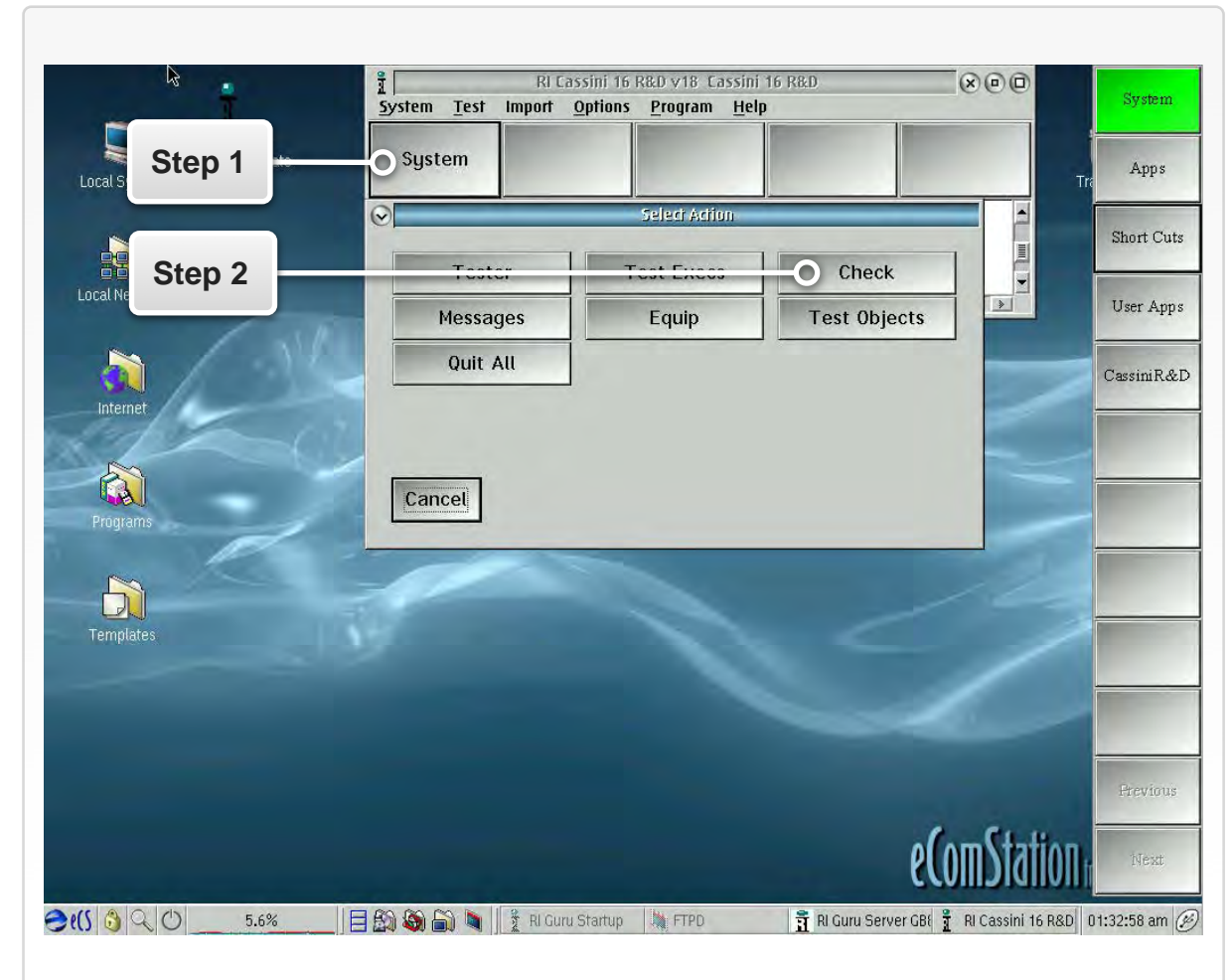
This function is performed by selecting the **System** button located on the left side of the main system window, and then selecting **Check**

from the pop-up window of button choices. Once the Check button has been selected, the UI will not respond to user selections until the pop-up window closes. The user can verify that the tester is performing the system check function by observing the processor activity meter located at the bottom of the OS screen and notice changes to any open Tester Configuration or Equipment Pool windows.

---

**CAUTION:** Attempting to execute other tester commands or functions while an active 'System Check' request is being processed can result in erroneous instrument configuration information and/or system walk back errors. Always wait for the pop-up window to close before continuing.

---

**FIGURE 1.59 SYSTEM CHECK**

A system check is performed by selecting the 'System' button from the main system window, and then selecting the 'Check' button from the pop-up window.

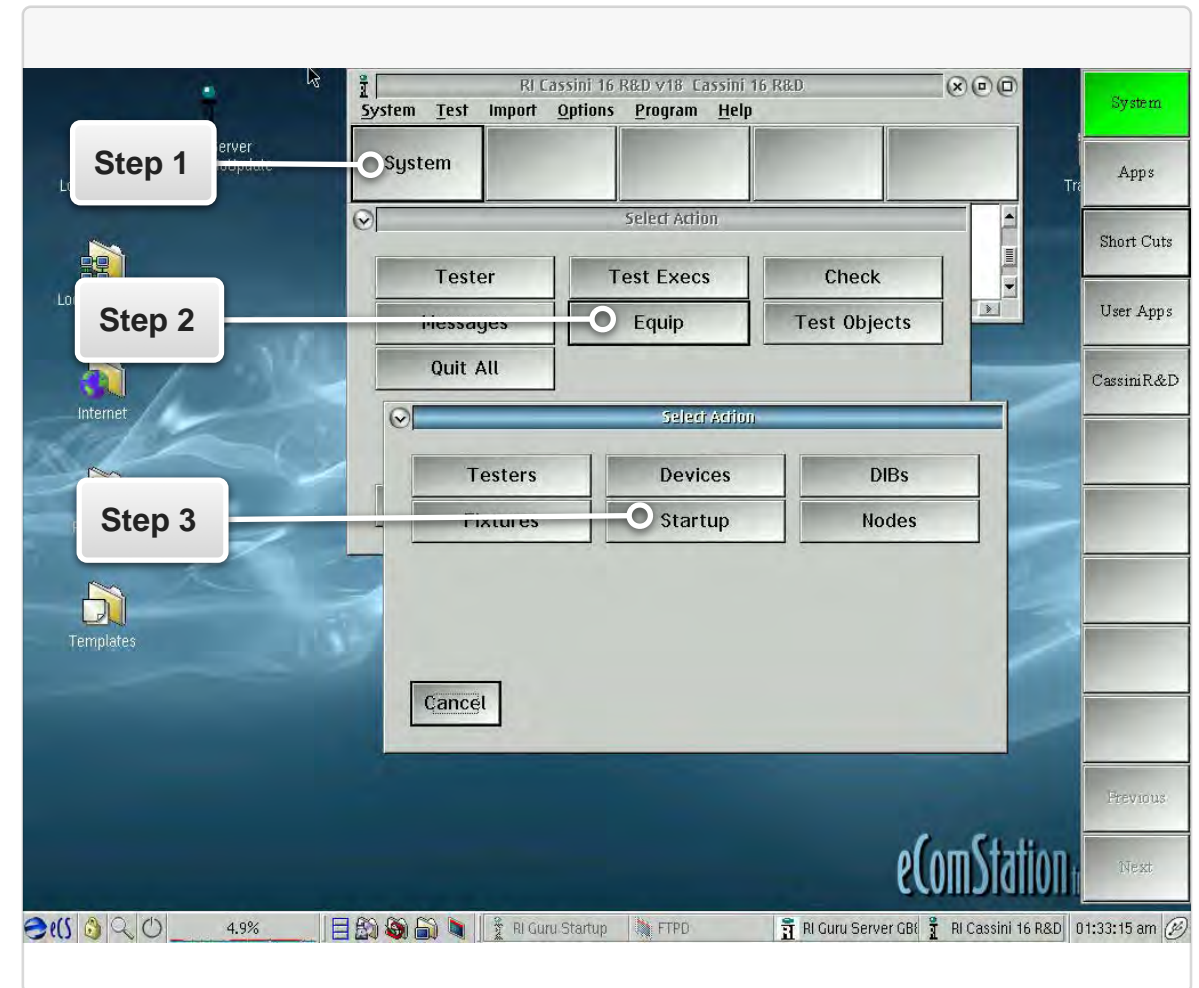


## SYSTEM STARTUP

The system startup function serves a similar function as the system check function. A system startup sends a software request to the Cassini controller to rebuild the entire RIFL node tree, hub, and attached instruments and equipment on the test head. This function will remove power from all instruments and equipment attached, rebuild the RIFL node-tree topology and recheck in all instruments connected to RIFL back into the system configuration. The system startup is a more thorough and exhaustive method for checking equipment and TIMs into the tester, and therefore more time consuming than a system check. Typically, startups are used as a soft restart of the test system if there is an unknown loss in communication with a test instrument module or modules.

*NOTE: Always remove fixtures and or diagnostic plates from the test head before performing a system startup. If the startup was successful, system checks are adequate for subsequent equipment additions to the test head.*

FIGURE 1.60 SYSTEM STARTUP



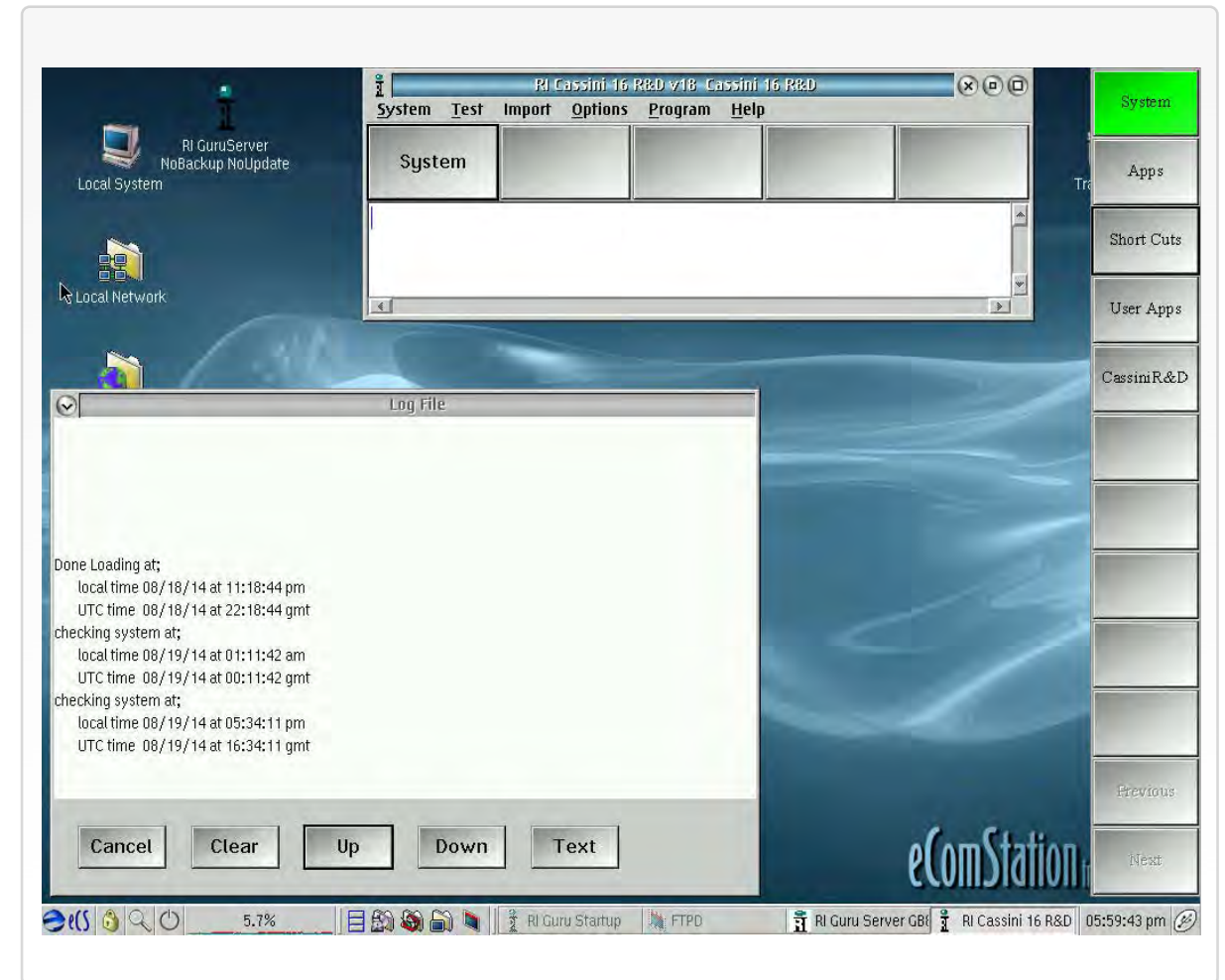
A system startup is performed by selecting the 'System' button from the main system window, then selecting the 'Equip' button and then 'Startup' button progression from the pop-up window options.

## MESSAGE WINDOW

The message window provides a console for system message information from the Cassini test software environment. Information such as system status, responses from applications, system warnings, and errors are displayed in the message window. Messages follows a common convention of general information and warnings in black text, and errors displayed in red text. It will display the date and time of system checks and instrument self calibrations as they occur. The window is also useful during test development, diagnostics or calibration, displaying compile warnings for instrument settings in black text, with compile errors in red. System errors such as RIFL communication loss to an instrument are also displayed in the messages window in red text. The console provides feedback confirmation of RIFL loopback tests conducted from the equipment pool. [Figure 1.61](#) shows an example of the messages window.

The message window can be accessed through the main system panel by selecting **System > Messages**.

FIGURE 1.61 MESSAGE WINDOW



The message window is shown at the bottom left. The displayed messages reflect a loaded Shortcut and two subsequent system checks completions.



## TESTER CONFIGURATION

The tester configuration window provides a comprehensive summary of the current system configuration. All instruments and equipment connected to the test system are displayed in this window such as: the system controller, test instrument modules, fixtures and diagnostic/calibration plates, and calibration kits. As well, software-created instruments and resources or “virtual instruments” as they are commonly referred to, are also displayed in this window. Examples of these virtual instruments include the ‘vna’ (combination of the Testset, Source, and Receiver TIM resources), ‘noise figure’ Device Control Definitions (register definitions), and calibration kits (data for calibration standards). [Figure 1.62](#) shows an example of the tester configuration.

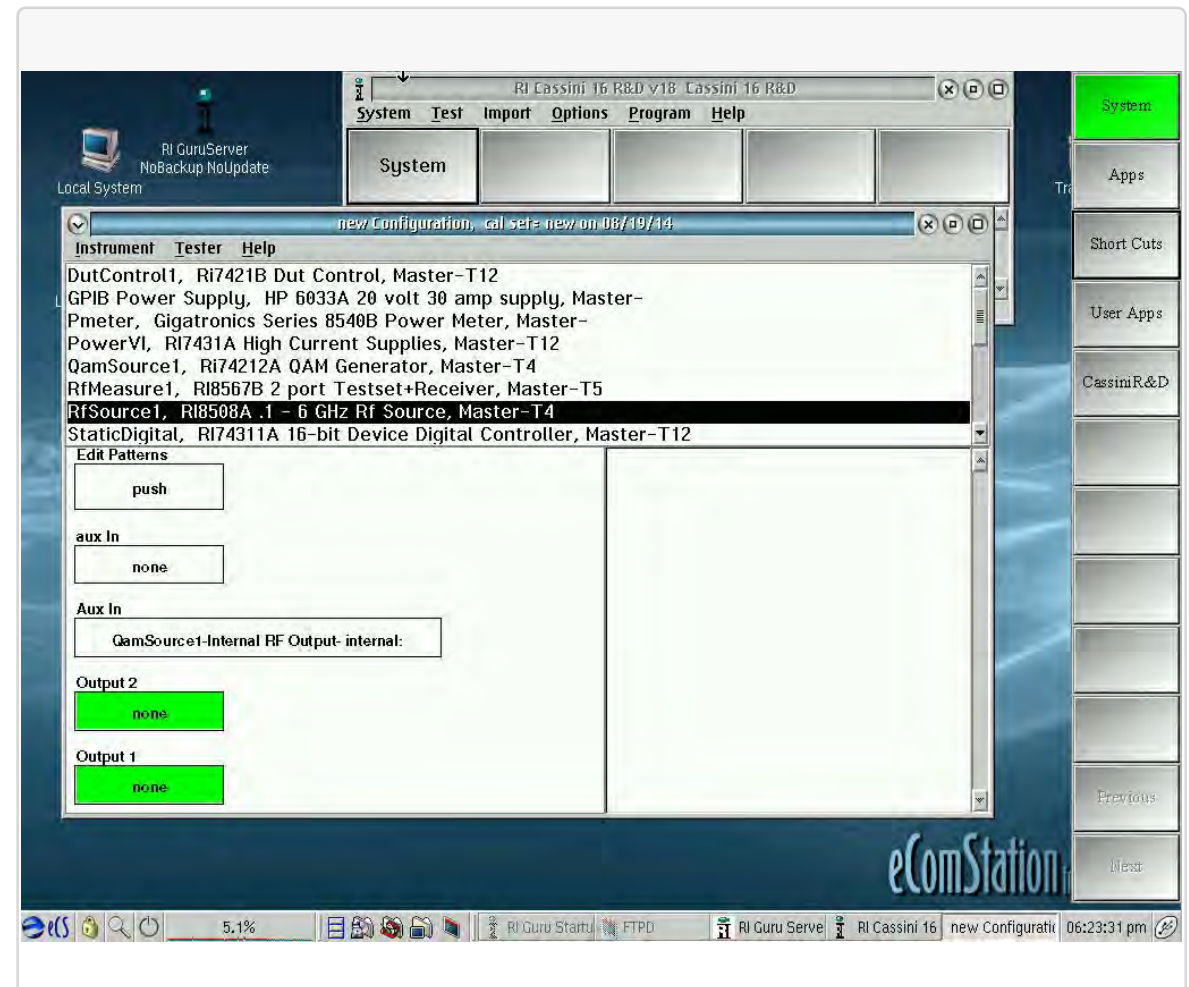
The configuration window can be accessed through the main system panel by selecting the **System > Tester** buttons.

*NOTE: Handler/GPIB Pods can only be viewed in the Equipment Pool window. Handler pods are factory programmed, but require onsite configuration to the handler type and local settings before use.*

Performing a **System > Check** or **System > Startup** will refresh this list. The tester configuration window is divided into three panes. The pane at the top of the window displays the connected equipment resources. Test instrument modules are represented by their individual sub-instrument model numbers in alphabetical order, i.e. - an RI8546 Device Power TIM is shown as three instruments: DUTControl,

Ri7421B Dut Control; PowerVI, RI7431A High Current Supplies; StaticDigital, RI74311A 16-bit Device Digital Controller. If the instrument is part of a TIM, the test head slot location is displayed at the end of the of the instrument name in the top pane. Multiple instruments of the same type will be represented with the sub-instrument name followed by an enumeration number. Depending on

FIGURE 1.62 TESTER CONFIGURATION VIEW



The tester configuration or tester view displays all installed instruments.

the configuration settings and/or instrument type, instruments may or may not contain an enumeration value for the first instrument instance, but subsequent instruments of the same type will have an enumeration of value of '2,' i.e - RFSource1, RFSource2 versus DUTControl, DUTControl2. Selecting an instrument from this list displays instrument-specific information in the lower left pane that varies by instrument. Typically, this information displays waveform pattern information and management on a source instrument or RF instrument's Input/Output port path definitions. Input/Output port names are displayed at the top of a box, with the path definition displayed internally. Green boxes denote path definitions for an I/O port that must be defined in software by a device connection definition or fixture definition. These software device connection definitions represent a fixture interconnect path in the device interface environment. Along with providing configuration information, several tester features can be accessed through the tester configuration window.

## ADDING INSTRUMENTS

Selecting an instrument from the list and then selecting the **Instrument** menu option at the top of the window will provide a drop down menu for: adding instruments, GPIB instruments, calibration kits, fixture definitions, and device interface board definitions to the system by choosing the corresponding menu selection.

## REMOVING INSTRUMENTS

Instruments can be removed by selecting an instrument from the list and then selecting the **Instrument > Remove** menu options.

## RENAMING INSTRUMENTS

Instruments can be removed by selecting an instrument from the list and then selecting the **Instrument > Rename** menu options. This provides a pop-up window to rename the selected instrument.

---

***CAUTION:** Changing an instrument name can affect test plans. Buttons and measurement blocks within test plans must match the button owner name to the instrument name listed in the tester configuration window. Conflicts between the owner name and the instrument name will result in test plan compile errors and failure to compile. This can only be resolved by changing the owner name to match the instrument name or renaming the instrument to match the owner. Always exercise caution when changing instrument names in a configuration.*

---

## SAVING A TESTER CONFIGURATION

The tester configuration can be saved to preserve user-defined instrument naming conventions and their associated instruments. This is useful for system setup that use custom naming conventions and/or defining a numbering convention of a multiple instrument setup to specific slot locations. It is also required to use the tester configuration from a Virtual Workstation simulator. To save a tester configuration select the **Tester** menu at the top of the window, and then select **Save** from the drop-down menu list.

## CALIBRATION & DIAGNOSTIC INFORMATION

Calibration information for an instrument can be viewed by selecting the **Instrument > Calibration** menu list options. This opens a sub-menu list with several options for viewing selected instrument calibration data, or launching the calibration and diagnostic tools for the specified instrument.

*NOTE: To calibrate or diagnose a TIM, always select the “System” instrument from the tester configuration list. Then select the Instrument > Calibration > Calibrate or Instrument > Calibration > Diagnose menu options. This will provide the list of calibrations or diagnostic plans for sub-instruments grouped by their TIM and organized in the order they should be executed in the system.*

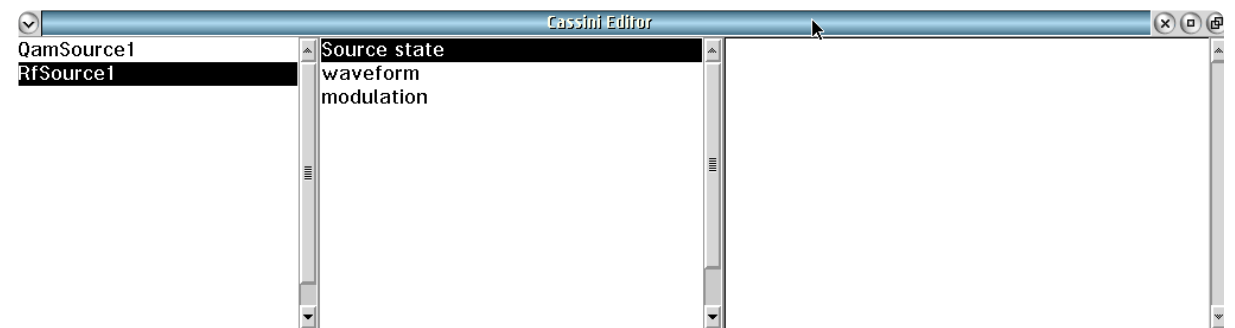
## EDIT PANEL

The Edit Panel or Editor, shown in [Figure 1.63](#), provides instrument buttons and measurement blocks used in the graphical test programming environment. The Editor window is divided into four panes. The three panes from left to right across the top display the list of available instruments in the current system configuration, a selected instrument’s subsystems, and a help dialog of a selected button from the bottom pane. The bottom pane of the window is populated by instrument setting buttons and measurement blocks from the selected instrument and subsystem selections.

*NOTE: The button values displayed in the Editor are the default settings of the instrument and can be changed before or after placing them in a test panel by left clicking on them.*

These buttons and blocks are placed within test plan panels to design multi-instrument measurements, algorithms, and test state-flow. The library of blocks and buttons are dynamically built from the system’s TIM configuration. The Editor is accessed by selecting **Tester > View** from the menu options of either the Configuration Window or from an open test plan.

FIGURE 1.63 EDIT PANEL EXAMPLE



<b>Frequency</b> 999	<b>Source 1 Attn</b> 0db	<b>Modulation</b> off
<b>Power</b> 0	<b>Source 1 Amp</b> off	
<b>Rf State</b> off	<b>Source Output Mode</b> Output 1	

*NOTE: Multiple edit panels can be open at the same time.*

For more information on using Edit Panel buttons in test plans, reference the [Introduction](#) section of the Graphical Programming chapter.

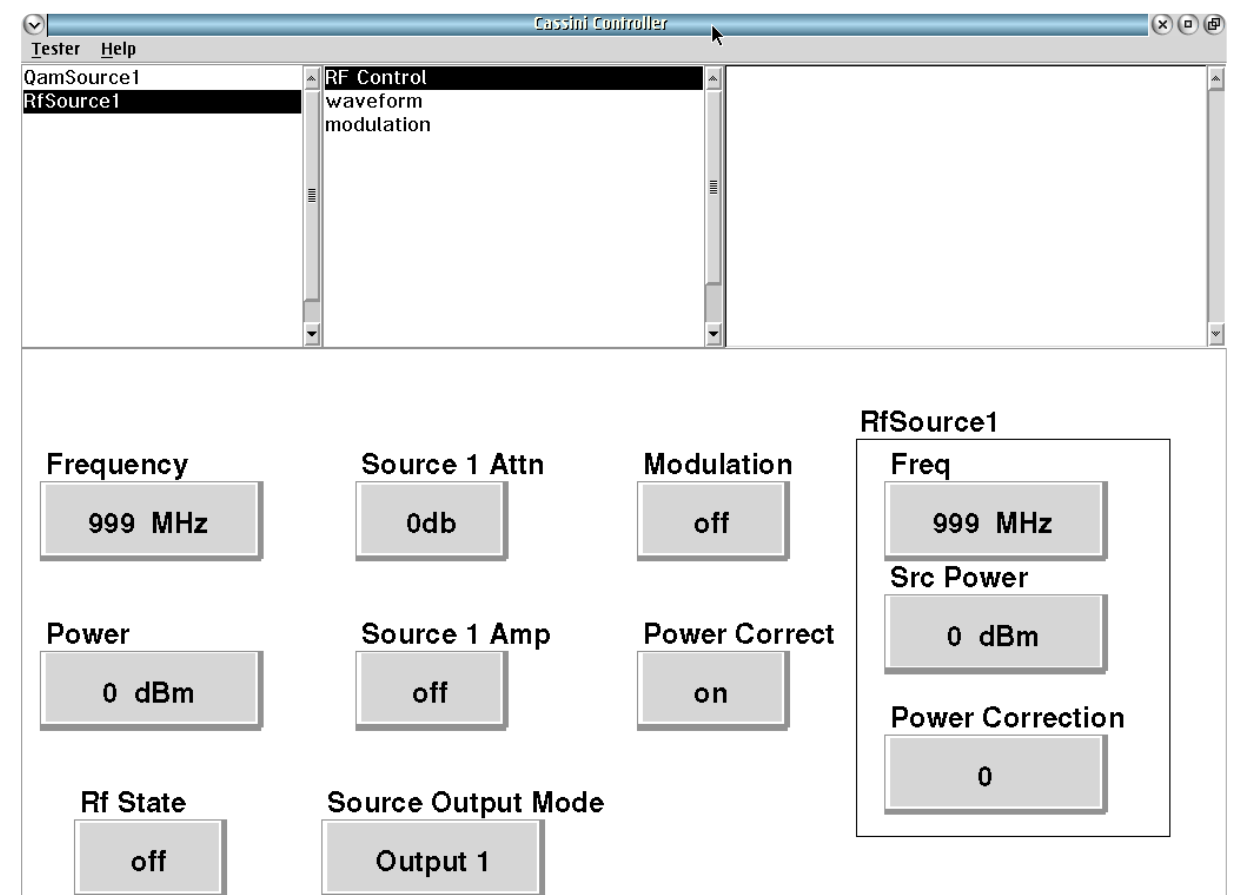
## CONTROL PANEL

The Control Panel or Controller, shown in [Figure 1.64](#), provides interactive buttons much like the view and controls of bench-top equipment for live control of the instruments. The Controller window is divided into four panes. The three panes from left to right across the top display the list of available instruments in the current system configuration, a selected instrument's subsystems, and a help dialog much like the edit panel. The bottom pane of the window is populated by interactive buttons from the selected instrument and subsystem selections and display the current instrument settings. Left clicking on the button allows the user to change the corresponding instrument's setting or captures data in a measurement display. This tool can also be accessed at breakpoints in test plans for in-situ instrument debugging. The control panel is accessed by selecting the **Tester > Control** menu selections. At a test plan breakpoint, the control panel can be accessed by selecting **Control** from the Breakpoint pop-up window options.

*NOTE: Multiple control panels can be opened simultaneously.*

**WARNING: Always return instrument controls to their default idle state settings by manually resetting the button values in the control panel or performing a System Check when finished with Control Panel use.**

FIGURE 1.64 CONTROL PANEL EXAMPLE



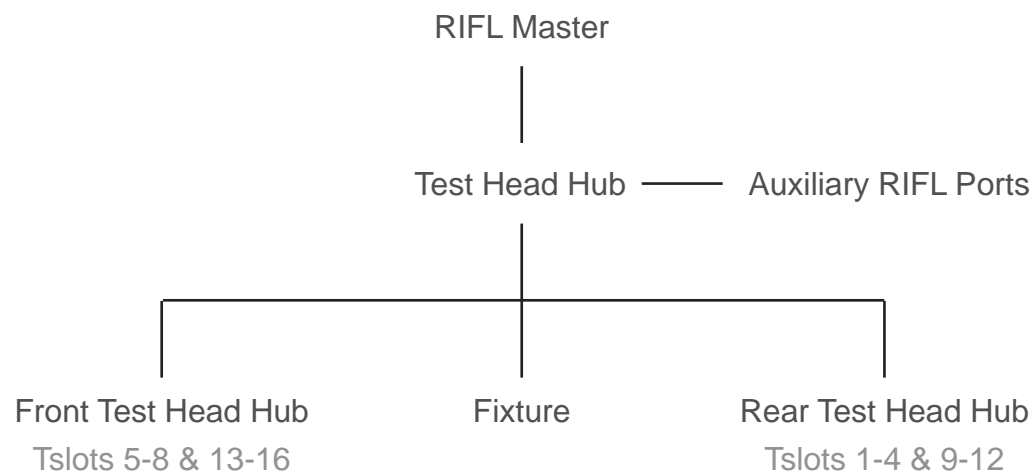


## EQUIPMENT POOL

The equipment pool window provides a hierarchical view of the Cassini test head configuration as expressed through the RIFL node tree. This window allows the user to view, test, and verify the status of the various RIFL nodes and hubs. When the test head is configured with TIMs, the user can view TIM information such as: their slot location on the test head, sub-instrument names, serial numbers, node ID, and base instrument information.

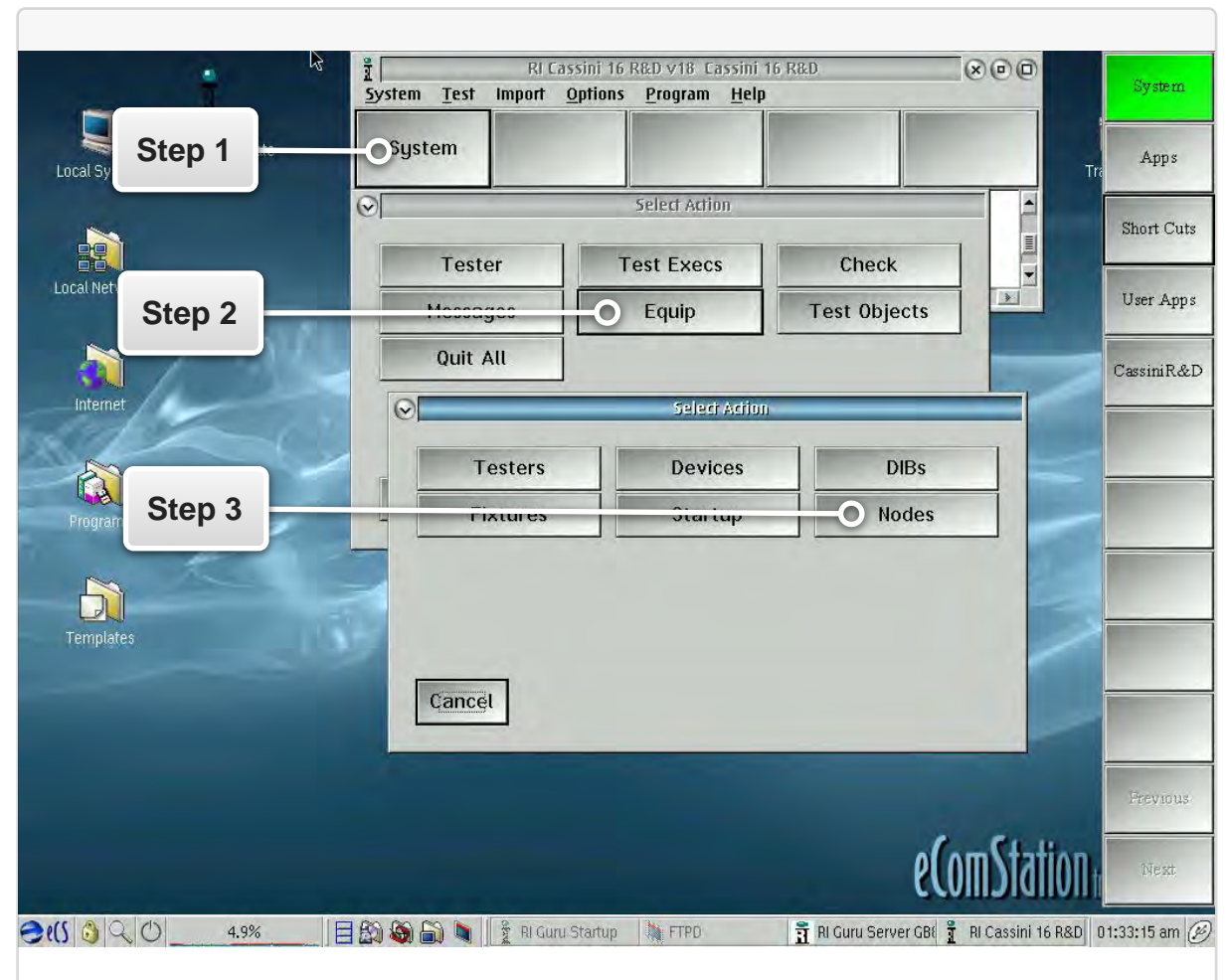
*NOTE: Handler/GPIB Pods can only be viewed in the Equipment Pool window. Handler pods are factory programmed, but require onsite configuration to the handler type and local settings before use.*

## RIFL NODE TREE



The diagram above illustrates the communication topology for Cassini's instrument communication system called RIFL (Roos Instruments Fast Link). RIFL provides instrument communication to various instruments and peripheral equipment on Cassini as well as serving as the data bus. The design is a hybrid topology consisting of a tree-star structure. The RIFL Master is located in the RI8574 System Controller and serves as the central hub which all data and communication are relayed for processing and analysis. Control

FIGURE 1.65 ACCESSING THE EQUIPMENT POOL





commands originating from the system controller are sent downstream to the Test Head Hub, located inside the Cassini test head. This hub provides the central point for communication with nodes on the Cassini test head. It supplies 4 auxiliary RIFL ports or nodes on the side of the test head closest to the infrastructure chassis as well as a dedicated node for fixture communication and two additional downstream hubs. The fixture RIFL port communicates with diagnostic/calibration plates and fixtures by way of an interface block on the top of the test head. The Front Test Head Hub and the Rear Test Head Hub make up two additional star topologies, providing communication nodes to each of the 16 TIM slots on the test head.

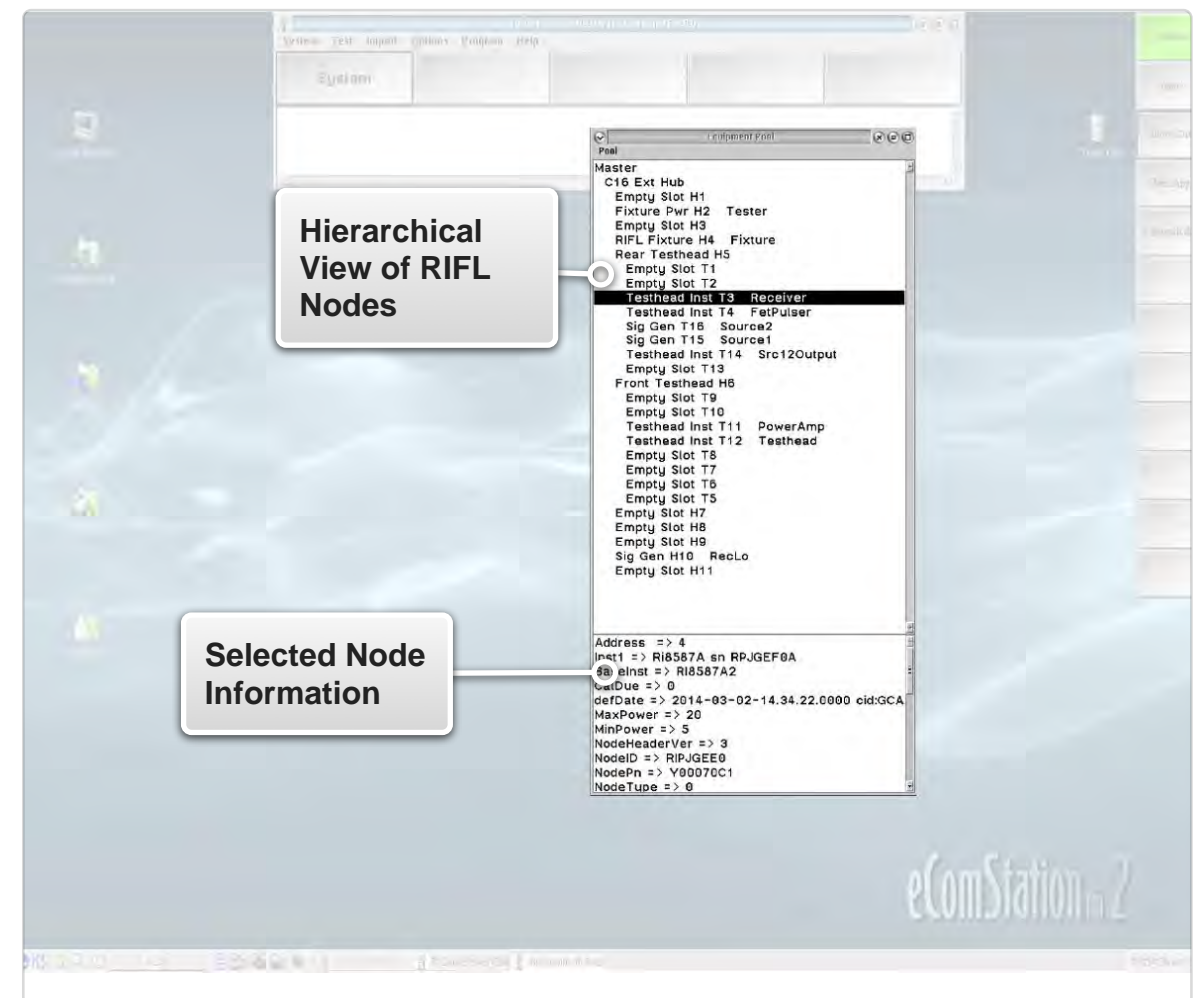
The equipment pool can be accessed through the main system panel, shown in [Figure 1.65](#), by selecting the **System > Equip > Nodes** options from the successive button windows launches the Equipment Pool.

The equipment pool window is divided into two panels. The top panel displays the hierarchical view of the RIFL nodes, hubs, and connected hardware. The panel updates with System Checks and instrument adds to the Tester Configuration window to show the current tester configuration. Selecting a node in the top panel highlights the node and displays more information in the lower panel of the equipment pool window as shown in [Figure 1.66](#). When a node with a TIM or instrument is selected the instrument name, serial number, node ID, and more are displayed in a scrollable list in the lower panel. Selecting and then right clicking on a node provides the user with several options as shown in [Figure 1.67](#).

The 'power off' command is an optional method for deactivating a TIM without removing it from the test head. A subsequent System Check command will bring the TIM back into the tester configuration. A System Startup command will rebuild the entire node tree from the RIFL Master and recheck in all attached TIMs in the Equipment Pool.

The 'Flash Led' command is used to intermittently blink the status indicator LED on the front panel of a RI7725 Source corresponding to

FIGURE 1.66 EQUIPMENT POOL FEATURES



the user's selection. This is useful for identifying individual sources in a multiple source system.

The 'RIFL Test' command will perform a RIFL loopback test on TIMs or instruments for the selected node or multiple nodes under a selected hub. This is useful for verifying the functionality of RIFL communication on hubs and TIMs. Loopback verification information is displayed in the System Messages Window.

---

**CAUTION:** The 'Power on,' 'Enumerate,' and 'Inspect' commands are for RI internal purposes only. These functions should only be used with supervision from a Roos Instrument's service or support engineer.

---

FIGURE 1.67 EQUIPMENT POOL RIGHT-CLICK OPTIONS

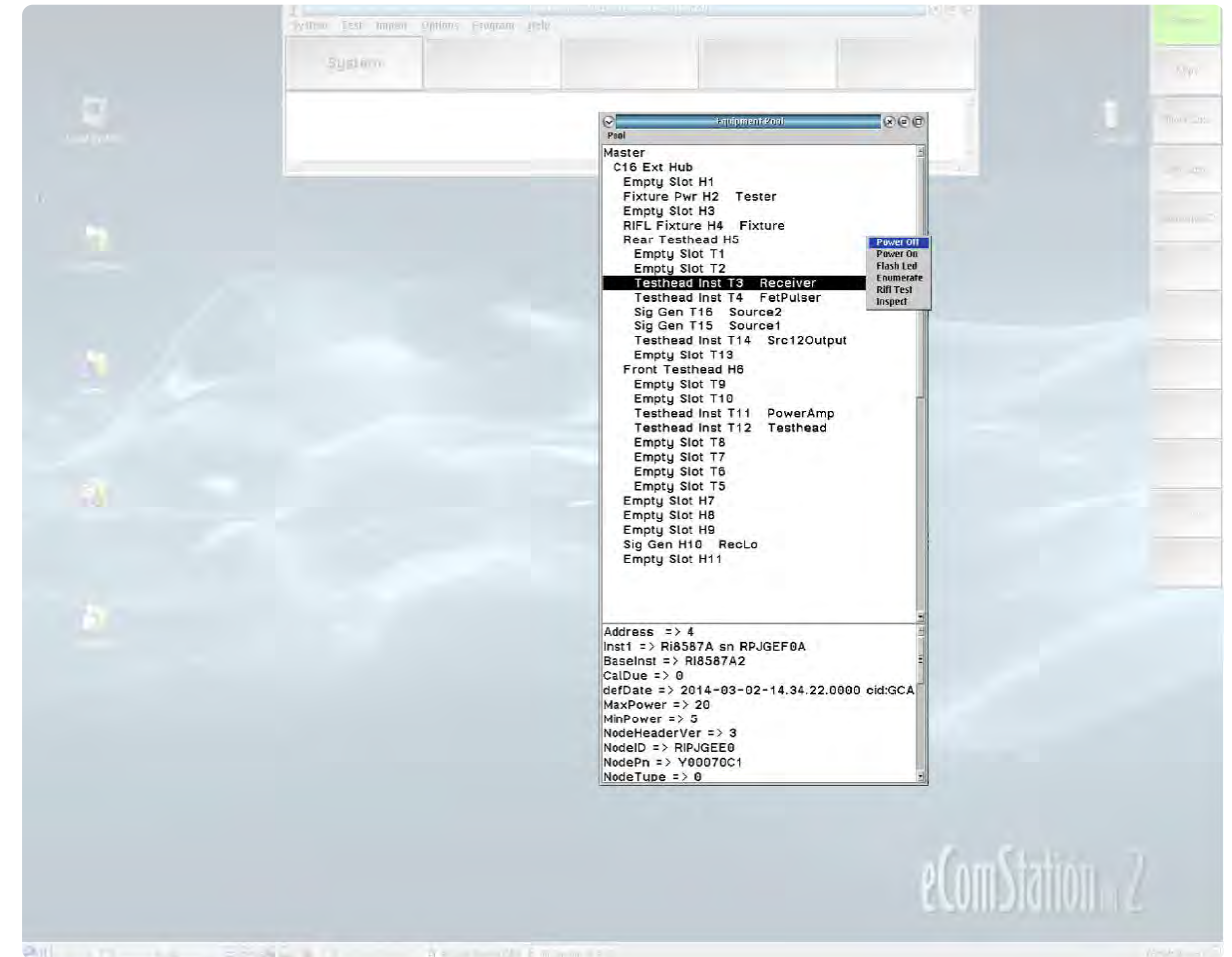
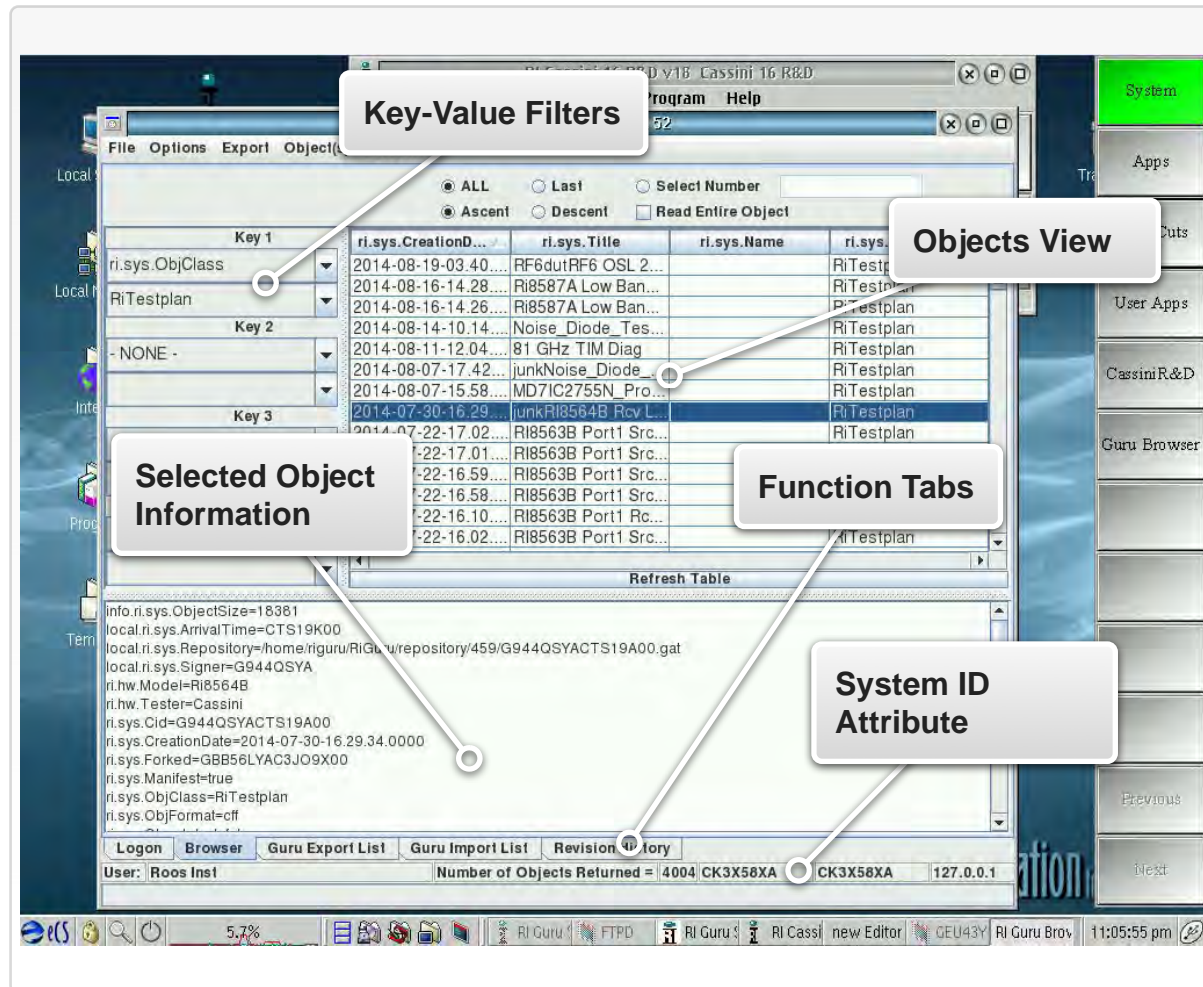




FIGURE 1.68 GURU BROWSER



TOPICS

[Guru Introduction & Concepts](#)

[Guru Browser](#)

[Viewing Objects in Guru Browser](#)

[Importing Objects with Guru Browser](#)

[Exporting Objects with Guru Browser](#)

[Object Revision History](#)

## INTRODUCTION

The Cassini test system manages all test system files, software resources, and test data using an [interplanetary file system](#) called Guru. Files are saved to and distributed from a central Guru server or multiple linked Guru servers through a peer-to-peer distributed database. This allows multiple Cassini ATE and Cassini simulators to access the same system of files. In addition to file sharing, Guru provides file management controls such as the ability to lock a tester configuration and file resources and limit user access control in the UI environment or files through permissions on individual testers and/or across test facilities. The Guru client on each system also self-manages its' connection to the Guru server to allow continuous operation of the test system in the event of network connectivity issues and to automatically reconnect. This streamlines the sharing and backup of resources across multiple Cassini testers, simulators, and servers providing many advanced features for production test including:

- Test resource distribution and management tools
- Software sandboxes and release control
- Local & network resource management
- Automated backup and restore
- Built-in file revision

Included in the following section are key concepts of the implementation and basic terminology to build a fundamental understanding of Guru. Also included are commonly used Guru applications, their functions, and their role in day-to-day workflow.



## GURU TERMINOLOGY

### OBJECT

A guru object is a file that is unique and immutable in the system. No two objects in guru are alike, including copies of an object or revisions to an object.

### ATTRIBUTE

An attribute of an object provides additional information about the object. Attributes form a key-value pair associated with their object that is used both for database-like indexing and queries as well for linking objects to their associated application functionality. The ‘key’ is the name of the attribute and the ‘value’ is the information. In other words, attributes provide information to the system and applications, telling them what the object contains and how to interact with it. While the number of attributes associated with a specific object depends on the object class, there are over 100 total combined attributes across all objects used for various file and resource management purposes.

### ATTRIBUTE KEY-VALUE PAIRS EXAMPLE

Key	Value	Description
ri.sys.Cid	G9MG7DYAAL78EI01	Creation Identifier (Global UID)
ri.sys.Owner	G9MG7DYA	Guru Identity that Created the Object
ri.sys.CreationDate	2010-04-16-06:06:18.0000	Object Creation Date/Time in UTC
ri.sys.Name	Sample Lot 45739	Name of the Object

## GURU CONCEPTS

Guru blends database-like properties with a modern file system to provide advanced file and application features specific to semiconductor production. To enable this integration, the system uses an object-oriented data paradigm. This means that every file and application resource on the test system is an object. Every object on the system contains attributes in key-value pairs. This relationship provides two main functions: 1.) It allows database-like indexing, queries, versioning, of objects and 2.) It links objects to their associated application.

### OBJECT/FILE SYSTEM

Like a traditional “file” on a file system, a Guru object stores data. Unlike a traditional file, Guru objects are immutable in that they can never change. When a Guru object’s data is changed, a new copy of that object is created, generating a new creation identifier attribute (Cid) with the same revision identifier attribute (Rid). Cassini applications use these objects to store and retrieve changes to the content, such as when saving changes to a Test Plan.

Object attributes are most commonly created and managed by Guru automatically. The object type, creation date, revision date, etc. is generated by the application that the software resource was created. Other attributes can be created by the user such as the name of the file or version, typically entered during data save prompts. Access to user-created objects or definitions can only be accessed through the appropriate system application. For example, to view or edit Device



Connection definitions, the user must launch the Device Connection Editor application. To access DUT Control definitions, the user must launch the Device Control Editor application. To browse and view all of these objects and their attributes, similar to a file directory viewer, the user can use the Guru Browser application.

## USER ACCESS CONTROL

All applications and objects are subject to user access control system that is enforced by Guru throughout the Cassini software environment, see [Figure 1.69](#). The user login credentials can be assigned role-based access control (e.g., engineering, maintenance, administrator roles, etc.) through user-defined permission attributes that restrict access to applications, file resources, and aspects of the user interface that perform operations in the software environment.

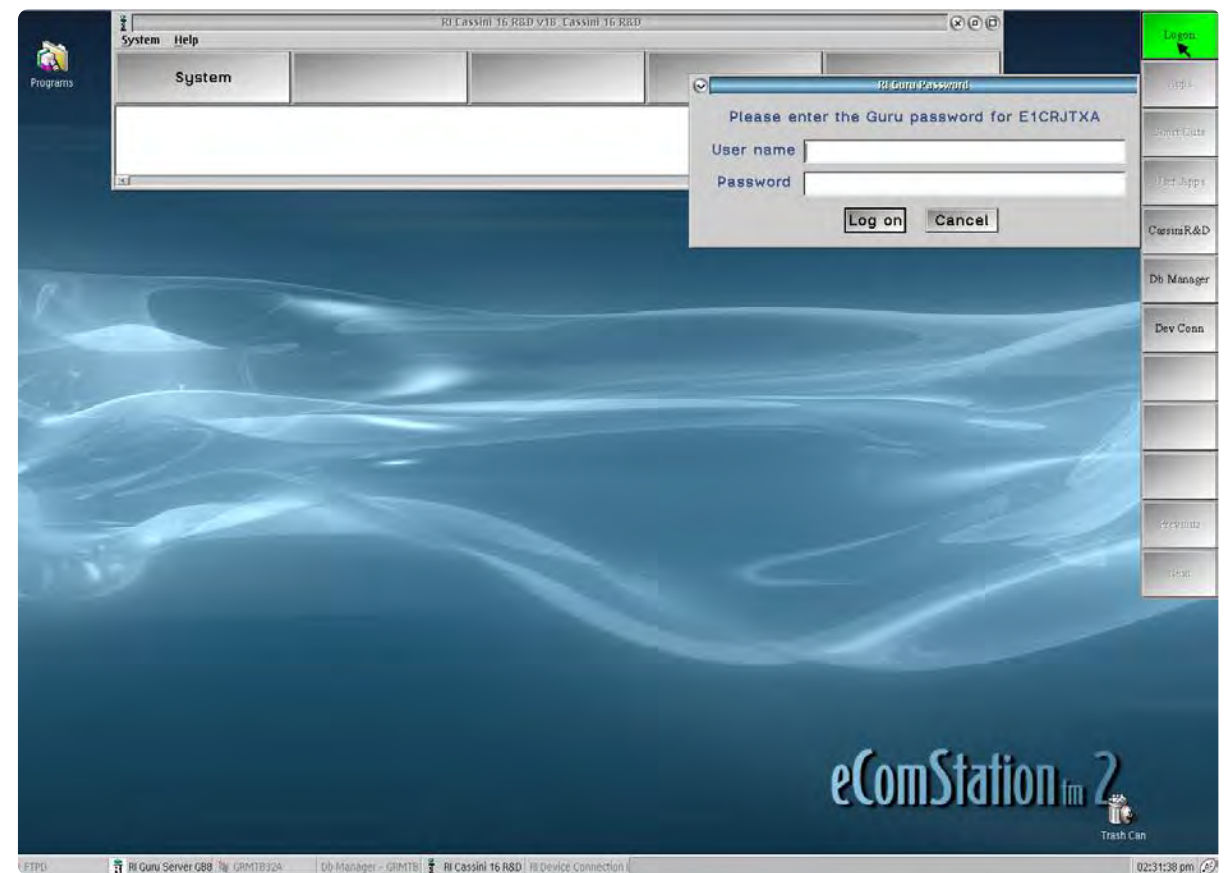
These permissions and the scope of their access can be defined by a system administrator to tailor roles through application and software resource access in the **Guru Permission Admin** application. Permissions are linked to specific user groups to assign appropriate roles to a user's account and simplifies common operations, such as adding a user, or changing a user's role/access. As well, Permissions can be combined in a hierarchy where higher-level roles include permissions used by sub-roles.

## NETWORK CONNECTIVITY

A Cassini test system's Guru automatically manages network connection to Guru servers. The Logon/Status button provides a visual cue to the user of the network status through real-time color-

coding. A green Logon/System button denotes the Cassini's Guru is successfully connected to an update Guru server. A yellow button Logon/System button denotes the Cassini's Guru has lost connection to an update Guru or is not connected to a Guru server. When the Cassini test system's local Guru is not connected to the network, the Guru server is offline and operates in local only mode. All files,

FIGURE 1.69 GURU USER LOGIN



Guru's access control system requires the user to login with a user name and password. Permissions can be assigned to users to restrict access to applications, file resources and/or components of the UI.

resources, and data created will only be stored locally on the test system. Similarly, resources and data available on the Guru Server will not be available to Cassini. When a network connection is available again, the button will change color from yellow to green signifying that the Cassini's local Guru will automatically backup all local files to and get remote updates from the Guru server.

*NOTE: If there is a loss of network connection, Guru will automatically attempt to reconnect to the Guru server. If the Log-In/System button changes from green to yellow, check your network connection, then notify Roos Instruments support.*

## FILE LOCALITY & DISTRIBUTION

In the background, Guru manages the local/networked storage and backup of files, test resources, and test data. Because of Guru's database-like file structure, a Cassini test system when connected to a Guru server automatically backs-up its resources and data to the server. This creates a local version of files and resources on the tester, and a networked copy on the server. Special key-value pairs allow Guru to manage multi-system file saves, versions, and restorations without loss of data or data collisions. This allows multiple Cassini test systems to be connected to a Guru server for shared resource distribution, back-ups, and data storage. This feature also allows new or replacement Cassini controllers (EPC TIM) to automatically download and recover test resources from a Guru server automatically upon installation.

## FILE VERSIONING

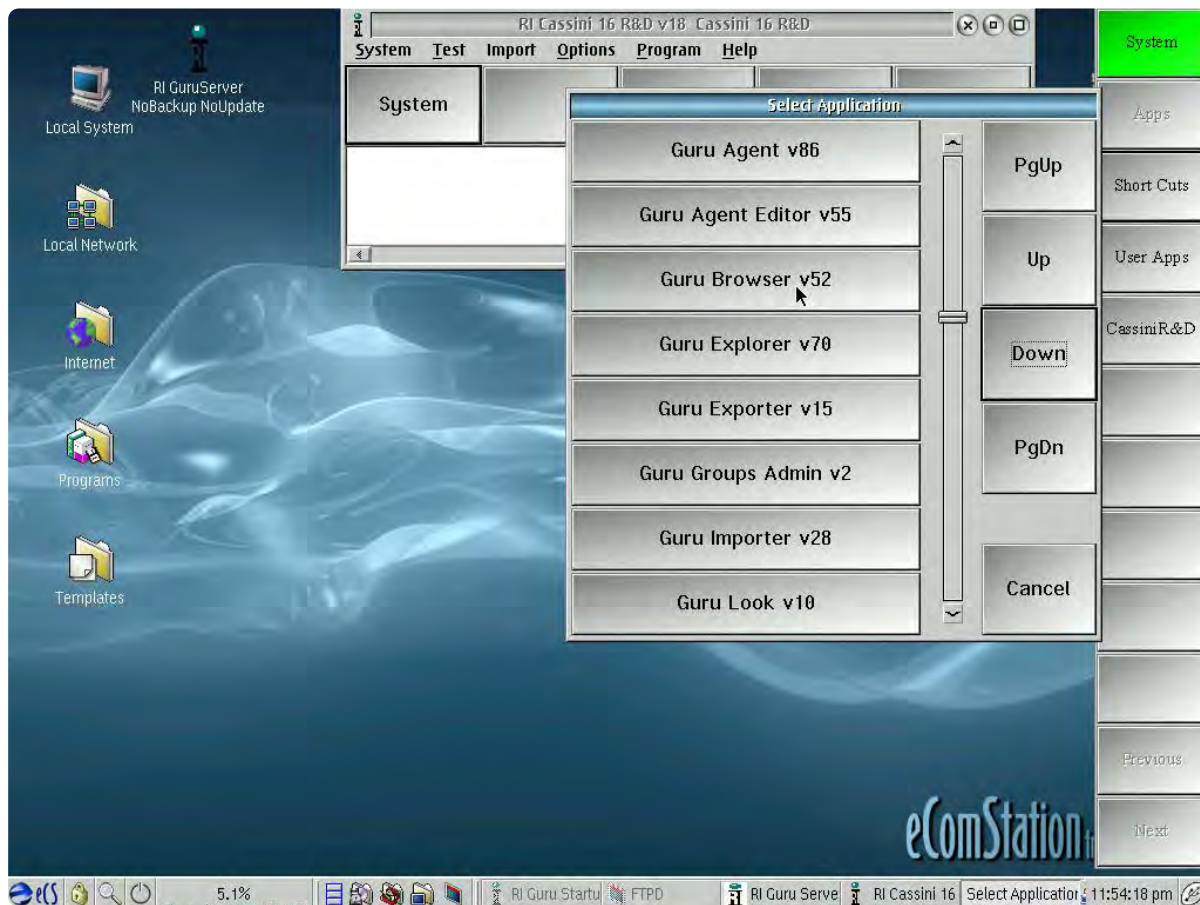
Guru provides automatic file versioning when saving files. This means users have a comprehensive revision history of files created, edited, and saved on a Cassini test system without having to perform a 'Save as' function. The system creates a revision attribute that preserves multiple versions without overwriting any previous versions. When opening files within an application on Cassini, Guru to automatically loads the latest version/revision of the requested file. In the instance of a test system not connected to a Guru server, this would load the latest local version. When connected to a Guru server, the test system's Guru will automatically retrieve the latest, most up-to-date version of a file/object found on the server. It then saves this version to the local database as well. This concept applies to files shared and/or edited on multiple Cassini test systems or virtual workstations.

## OBSOLETE OBJECTS

Guru object versioning insures that the most current object is available for the requested software resource. However, in some cases it is necessary to remove objects from selection menus and applications that are no longer needed. In Guru, objects that are no longer needed are obsoleted. Obsoleting an object in Guru does not delete the object, but creates a 'obsolete' attribute that instructs programs and applications that the resource is no longer used. This action removes the unwanted object from views and menus in applications such as the Guru Browser. This "view removal" applies to networked versions of the object, meaning once an object is obsoleted on a Cassini's local Guru, it will be obsoleted on the Guru Server and all network

connected Cassini systems. Obsolete objects lose all previous revisions of that object, so only one copy of the object is retained in case it needs to be retrieved for later use.

FIGURE 1.70 ACCESSING GURU BROWSER



Access Guru Browser by selecting the Apps button and then selecting Guru Browser from the scroll list of applications

## EXPIRE ON DATE FOR TEST DATA

The large storage capacity of a networked Guru and the relatively small file size of objects allows every revision of an object to be retained. However, in some instances it is desirable to remove unwanted or extra objects from the database to free up storage. To accommodate this, objects can be assigned an “Expire On” date attribute that is set when the object is first created. Once the expiration date elapses, the Guru object will be permanently deleted from the local and all network connected Gurus and will no longer be recoverable.

*NOTE: Only RiTestData objects include ‘Expire On’ date attributes. The default Guru expiration date for RiTestData objects is 30 days. The Expire On duration is defined in the Exec dialog by the system administrator. Contact your Cassini ATE administrator or RI support for assistance with ‘Expire On’ settings.*

## GURU BROWSER

The Guru Browser application provides a search, import, export, and revision history viewing tool for all objects and resources on a Cassini test system and networked Guru Servers. It is accessed through the Apps button found on the right side of the screen of the Cassini test system environment as shown in [Figure 1.70](#).

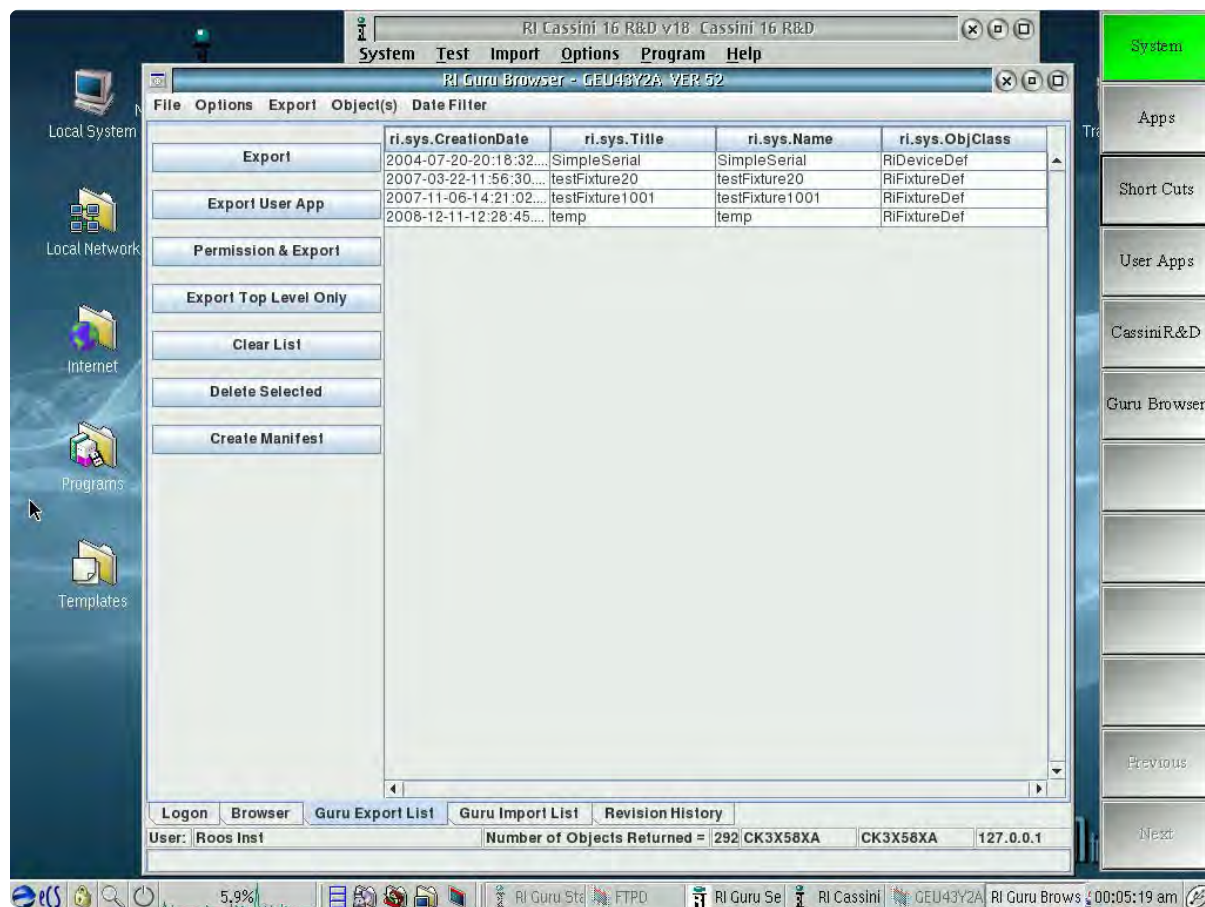
## DESCRIPTION

The Guru Browser window, shown in [Figure 1.68](#), displays objects in a tabulated view in the center pane. Each row represents a single object with columns representing an attribute key type. Left-clicking



on an object in the tabulated view will highlight the object row and display all object key-value pairs in a list view in the pane below the tabulated view. This list of key-value pair attributes provides the user with more information about the object such as: object size, object class, the object's creation date, Guru ID of the system that created it, and more. Left-clicking on a column heading will organize the object rows in ascending or descending order with respect to the selected key type. On the left side of the Guru browser window are drop-down lists selections of attribute key-value pairs. The drop-down selections

FIGURE 1.71 GURU EXPORT LIST TAB VIEW



allow the user to filter object searches against up to four key-value pair criteria. Listed along the bottom of the Guru Browser window are the function tabs. Clicking on these tabs switches between the various functions of Guru browser, showing a pane optimized for the selected feature functionality.

## GURU EXPORT LIST

The Guru Export List tab is used for exporting objects and/or groups of objects from a Guru as .gzp files. An example of the Guru export list layout is shown in [Figure 1.71](#). This tool is useful for transferring Guru objects via email, FTP, USB flash drive to Roos Instruments support or another company. Objects from the browser tab can be added to the export list by selecting them in the tabulated view and choosing the **Export > Send to Export List** options from the Guru Browser's menu selection or right mouse button menu. The list of objects are displayed in their tabulated view of the export list. The various export list actions are provided in the pane on the left. Choose **Export** to create the .gzp file. The user is provided an opportunity to add comments to the file and select the path and file name.

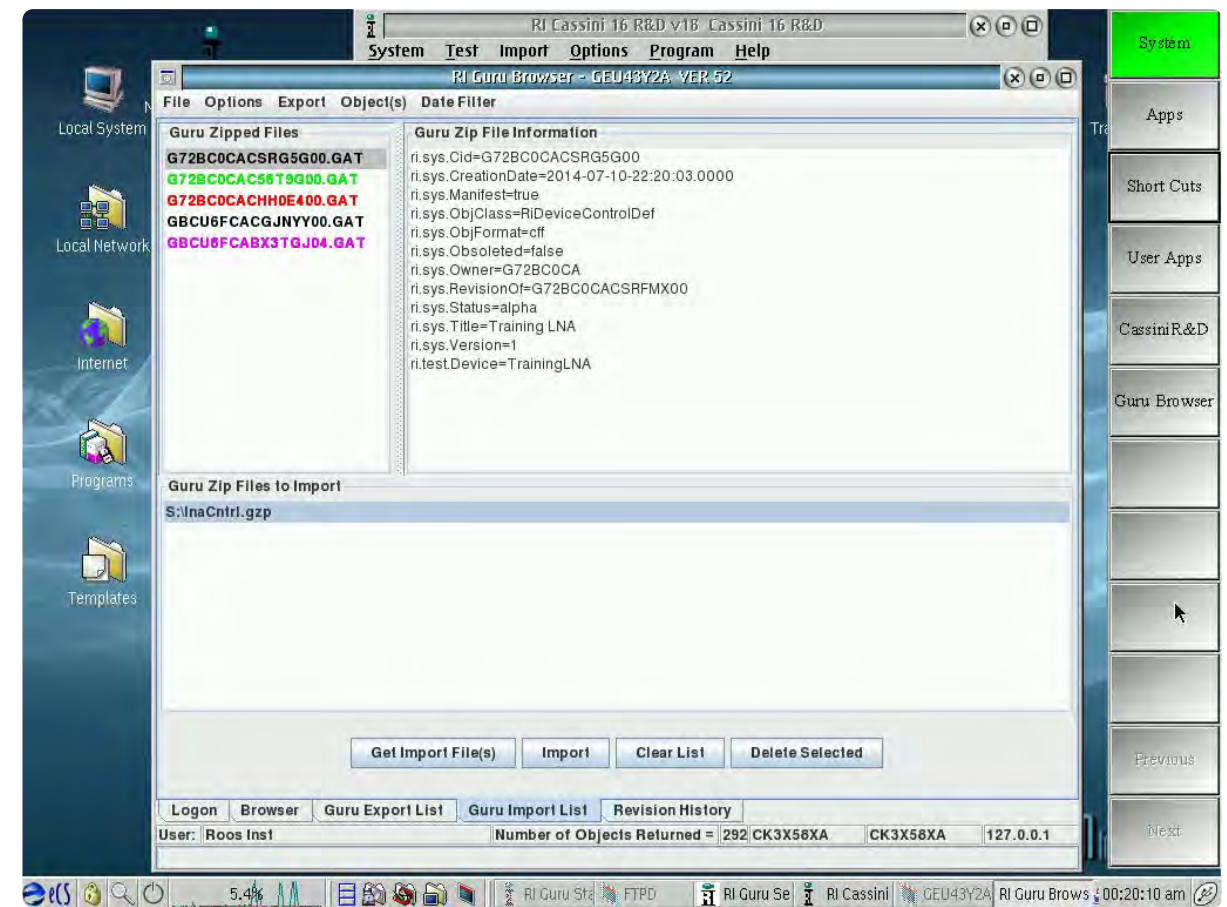
## GURU IMPORT LIST

The Guru import list tab is used for importing objects and/or groups of objects into Guru from a .gzp file attachment via shared network or USB flash drive. This tool is useful for loading objects such as TIM-specific calibration data into a Cassini test system's local Guru. An example of the Guru import list tab layout is shown in [Figure 1.72](#). The import list tab is divided into three panes. The bottom pane lists .gzp files to be imported into Guru. Selecting the Get Import File(s) provides a pop-up window for selecting .gzp files for import. The selected .gzp will be listed in the lower pane of the window. Selecting a .gzp in this list, and then left-clicking the upper left pane will list the contents of the .gzp file, typically objects or groups of objects as .GAT files. Highlighting these .GAT files by left-clicking on a file in this pane will display a list view of the object's attribute key-value pairs in the pane to the right. Selecting the Import button on a selected .gzp file will import its contents in Guru. Guru will automatically resolve revision/version conflicts of imported objects with the system's local Guru. The importer GUI provides visual cues of the revision resolution actions the importer will take with individual objects within an imported file as shown in [Figure 1.72](#):

- **Green** text denotes objects that do not currently exist in the local Guru and will be imported
- **Red** text denotes that object to be imported is newer than the version that exists on the local Guru. This object will be imported, and when requested by an application, the imported version will be used. The older version will be saved in the local guru's revision history.

- **Magenta** text denotes that object to be imported is older than the version that exists on the local Guru. This object will be imported, and when the object resource is requested by an application, the current version on the local Guru will be used. The imported older version will be saved in local guru's revision history.
- **Black** text denotes that the object already exists in the local Guru and is the most current version and as such, the object in the import list will not be imported.

FIGURE 1.72 GURU IMPORT LIST TAB VIEW





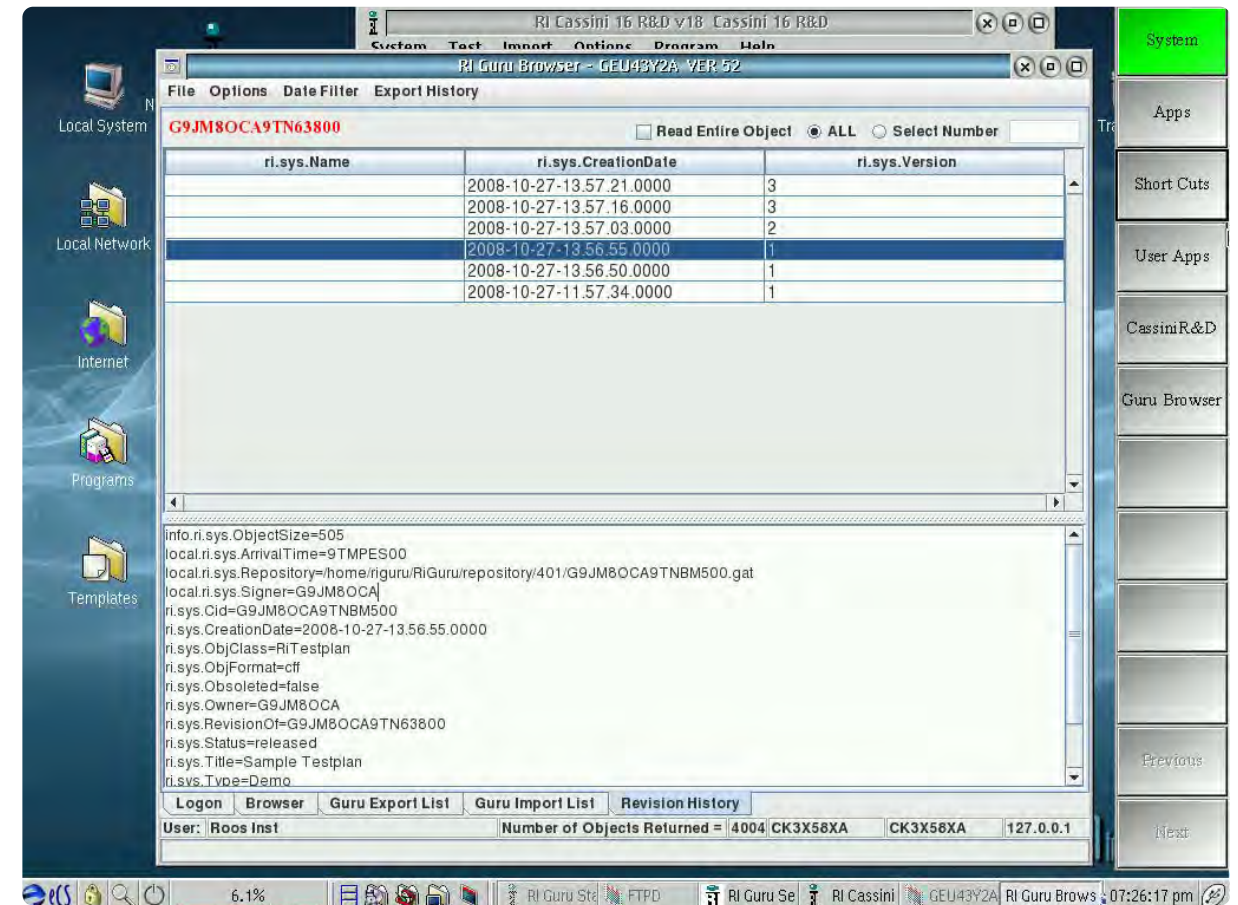
*NOTE: Always save resources and close applications that may create versions of objects that are being imported.*

## REVISION HISTORY

The Guru revision history tab is used for viewing the revision history of an object. An example of the revision history tab layout is shown in [Figure 1.73](#). Selecting an object in the tabulated view of the Browser, and then clicking on the Revision History tab will display a table view of the selected object's file history in the top pane. The columns of the table view display the object's Name, Creation Date, and Version attribute keys. Left-clicking on the column headers will sort the table in ascending or descending order with respect to the selected key type. Left-clicking on a version in the table will highlight the row and display or refresh the object version's information in a list view in the pane below the table. Right-clicking on an object revision in the table provides a menu with options to 'Remove from local,' 'Make Last RevisionOf,' and 'Send to Export List.' The 'Remove from Local' option will remove the selected object version from the local Guru. The 'Make Last RevisionOf' option will make the currently selected version of the object into the latest version. Applications that use this object will now use this version of the object. The 'Send to Export List' option will add the selected version to the Guru Export List.

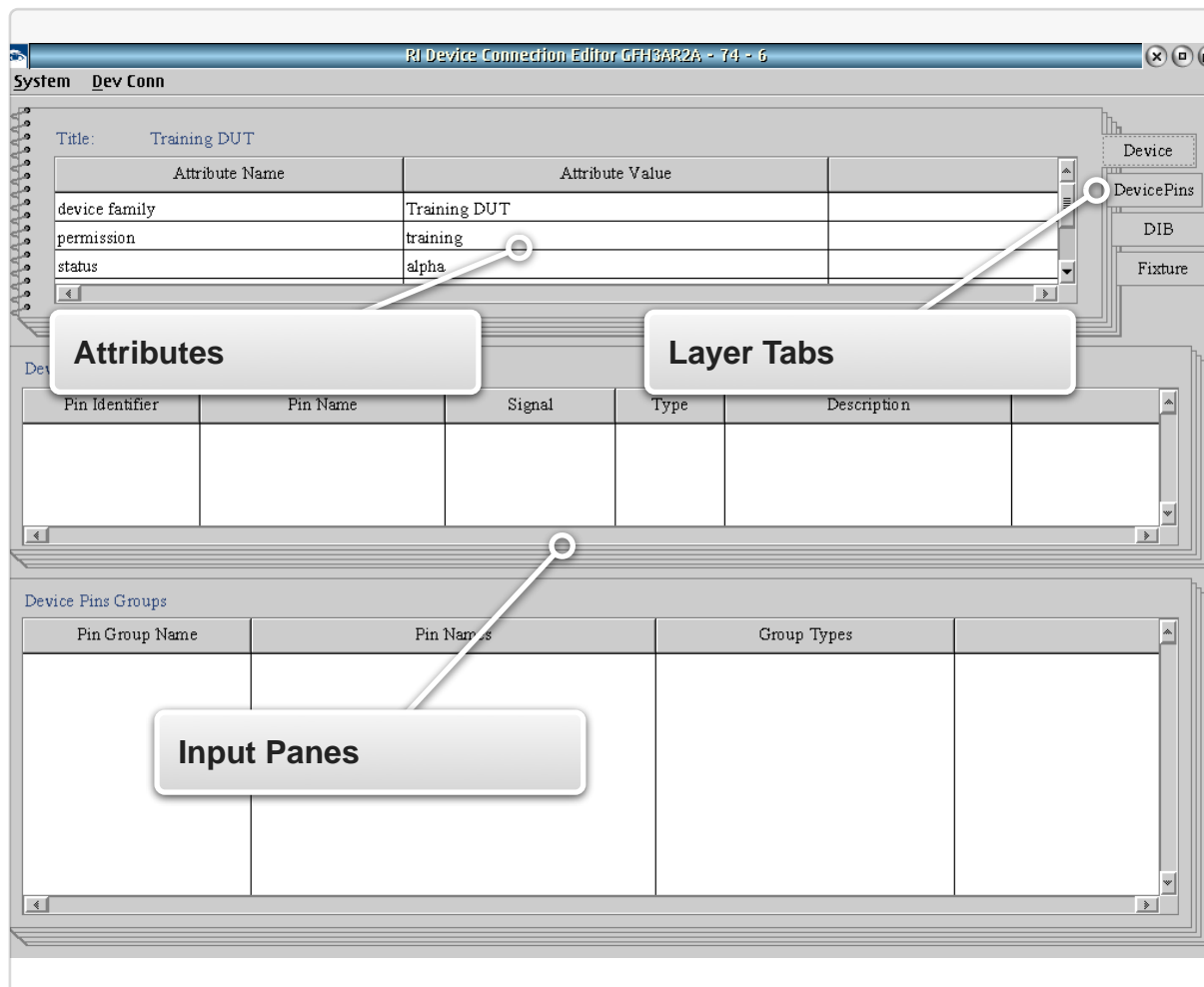
**CAUTION: DO NOT remove or alter the revision version of an object without consent from authorized personnel.**

FIGURE 1.73 GURU REVISION HISTORY TAB VIEW



# DEVICE CONNECTION EDITOR

## INTERACTIVE 1.2 DEVICE CONNECTION EDITOR



### TOPICS

[Introduction](#)

[User Interface](#)

[Device Definition](#)

[Device Pins Definition](#)

[DIB \(Device Interface Board\) Definition](#)

[Fixture Definition](#)

## INTRODUCTION

The Device Connection Editor allows the user to define software objects representing the resource mapping layers between TIMs and from TIM instruments to DUT pins. These layers, defined as *Fixture*, *Dut Interface* and *Dut*, serve as the tester integration and enable the user to dynamically reconfigure the tester resources for different

FIGURE 1.74 ACCESSING THE DEVICE CONNECTION EDITOR



The Device Connection Editor can be accessed from the Cassini Apps list as shown above.

applications. In addition, the integration layers allow cascaded calibration path names used for RF interconnections, and enable software control of relays/switches in the Fixture and Device Interface Board (DIB). The software objects are linked to their associated Fixture or DIB hardware with a unique serial number chip (a.k.a. electronic serial number or ESN) that identifies the resource in the hardware configuration. This allows the software to identify and load calibration and control resources automatically during [System Checks](#) and [Startups](#).

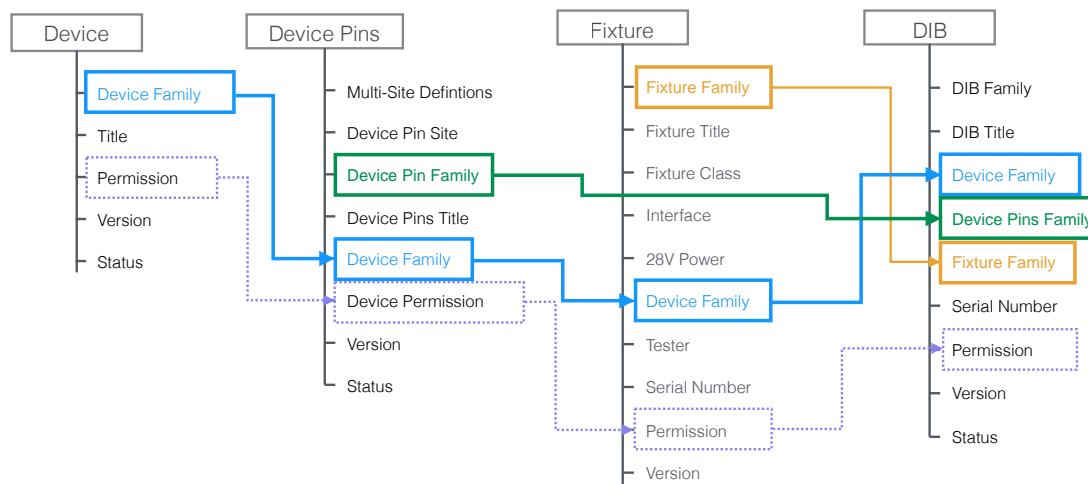
Resource mapping in the Device Connection Editor is divided into four layers: **Device**, **Device Pins**, **DIB**, and **Fixture**. The Device Pins, DIB and Fixture layers are three configurable components of the device interconnect environment and the Device layer serves as the target device for the application. Combined, these allow the user to tailor the test system resources to a specific device or a family of devices. The following section describes:

- The Device Connection Editor user interface
- The interrelation of resource mapping layers
- How to create and modify device interface layer definitions
- How to link the device interface software objects to their associated hardware

## USER INTERFACE

The Device Connection Editor provides three editable panes, the top pane has Layer tabs that provide their corresponding panes with contextual input forms for their respective Layer, see [Interactive 1.2](#). The upper pane displays the Attributes form and the lower two panes display DIB and Fixture connection forms. The top pane contains global information about the interconnect layer's software object such as version (*Version* attribute) and release status (*Status* attribute) as

FIGURE 1.75 ATTRIBUTE LAYERS & CONNECTIONS



The diagram shows the four layers of the Device Connection Editor and their associated attributes. Shared attributes link layers in the software for named path and pin resource mapping to cascade vector-error correction or offset in the calibration values for each layer.

well as specialized attributes that link the different layers together in the hierarchy shown in [Figure 1.75](#). This hierarchy of layer attributes also serves as the workflow in the Device Connection Editor:

1. Create a target device.
2. Define the pins/ports of the device to be tested.
3. Define the Fixture interconnect (integration layer) for the device or application.
4. Define the Device Interface Board (DIB) resource mapping from the Fixture to the Device Pins.

In addition, the specialized attributes (*Device Family*, *Permission*) narrow search results for other layers. When a Device is loaded in the device connection editor, subsequent Device Pins, DIB, and Fixture load dialog windows default to displaying objects that share the same *Device Family* and *Permission* attributes of the loaded Device. While a shared *Device Family* attribute between layers connect them, the *Permission* attribute enforces user access control to the objects created in the Device Connection Editor and their use in the Cassini software environment. This restricts viewing and editing of these objects to users who are members of a group or role with access to that permission.

*NOTE: Contact your Cassini system administrator for information on user permission access.*



The **Dev Conn** menu changes depending on what Layer tab is selected. For Example, to load a Fixture, first select the Fixture tab, then choose **Open** from the **Dev Conn** menu.

While access control is set from the [Guru Logon](#) button, the Device Connection Editor application allows for login with a different user within the application only. This allows for different user permission/ access control within the Device Connection Editor application.

**To login with a different user in the Device Connection Editor:**

1. From the menu options select **System > Logoff**.
2. From the menu options select **System > Logon**.
3. Enter the user name and corresponding password for the desired user in the RI Guru Password window and select **Log On**.

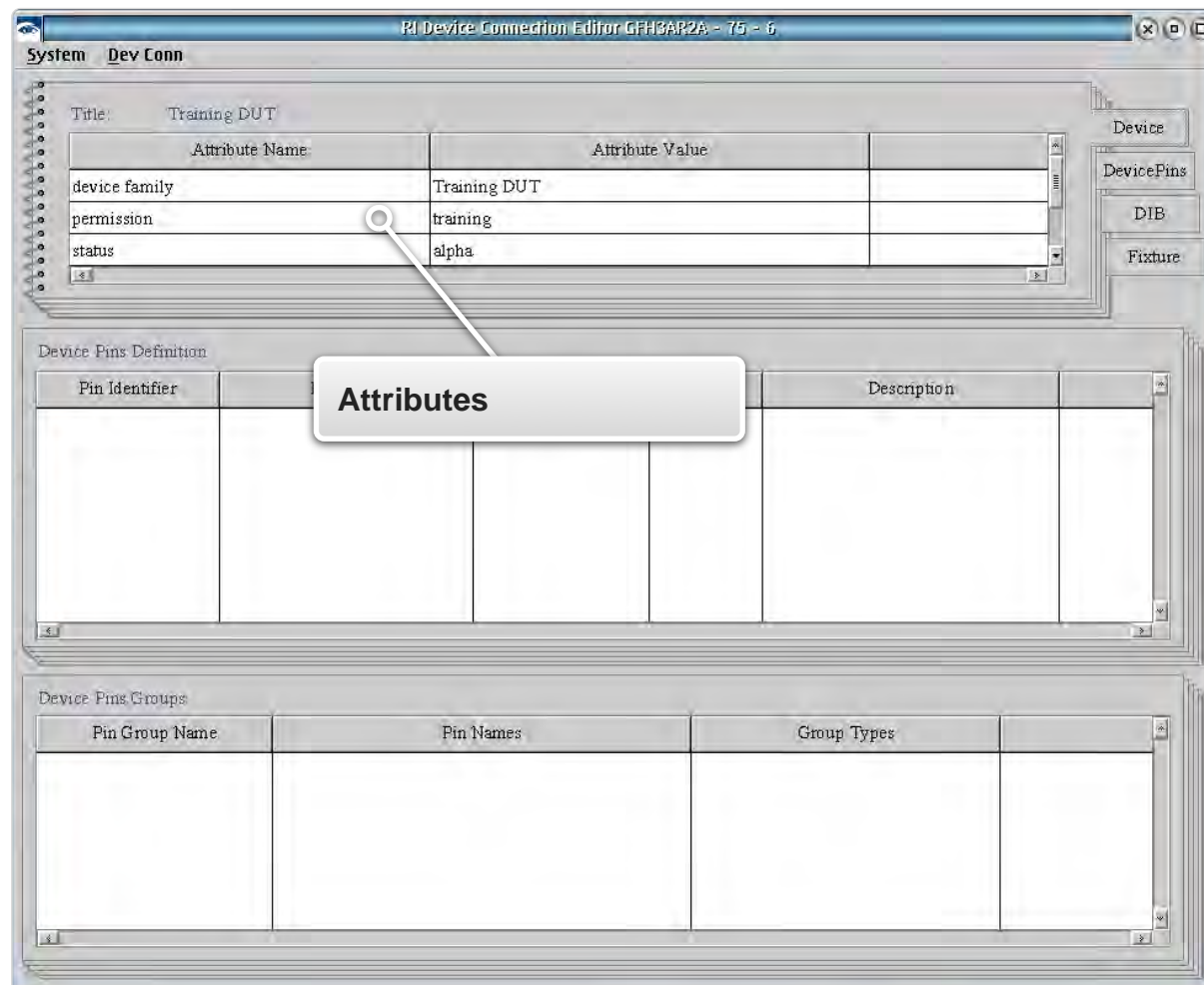
*NOTE: The Logoff menu option only applies to the Device Connection Editor application and does not affect access for other applications or future applications launched from the Guru > Apps button.*



## DEVICE DEFINITION

Accessed from the **Device** tab, the Device object or Device Definition defines a target that subsequent device pins, device interface board, fixture and/or Device Control Definitions will be associated. This layer only contains user-defined attributes. Guru uses this Device object (*Device Family* attribute) to link all of the layer definitions created in the Device Connection Editor automatically when importing or exporting Fixture, DIB, Device Pins, and/or Device Control definition resources.

### INTERACTIVE 1.3 DEVICE DEFINITION



#### To create a new Device:

1. Select the **Device** tab from the attributes pane.
2. From the menu options select **Dev Conn > New Device...**
3. In the New Device pop-up window fill in the attribute fields shown in [Figure 1.76](#) and listed below with their descriptions:

*Device Family* is used to tag and link all layers (**Device Pins**, **DIB**, and **Fixture** definitions) in the Device Connection Editor that are related to this device. It is recommended to use a generic Device Family attribute value.

*NOTE: These attributes are used to filter available definition selections in Load windows in the Device Pins, DIB, and Fixture tabs to the currently loaded Device.*

*Device Title* is the user-specified name of the target device. In a family of devices it is used to identify a specific variant of a device.

*NOTE: The Device Title value defaults to the Device Family value.*

*Permission* assigns a user-defined value that can restrict read, write access to the Device object in other applications and file resources in the software environment according to User Access roles in Guru. See the [User Access Control](#) section of Guru for more information. It is a shared attribute value across related Device Pins, DIB, and Device Control definitions (see [Figure 1.75](#)) that is also used for

category identification to narrow search results in Load windows in the Device Connection Editor.

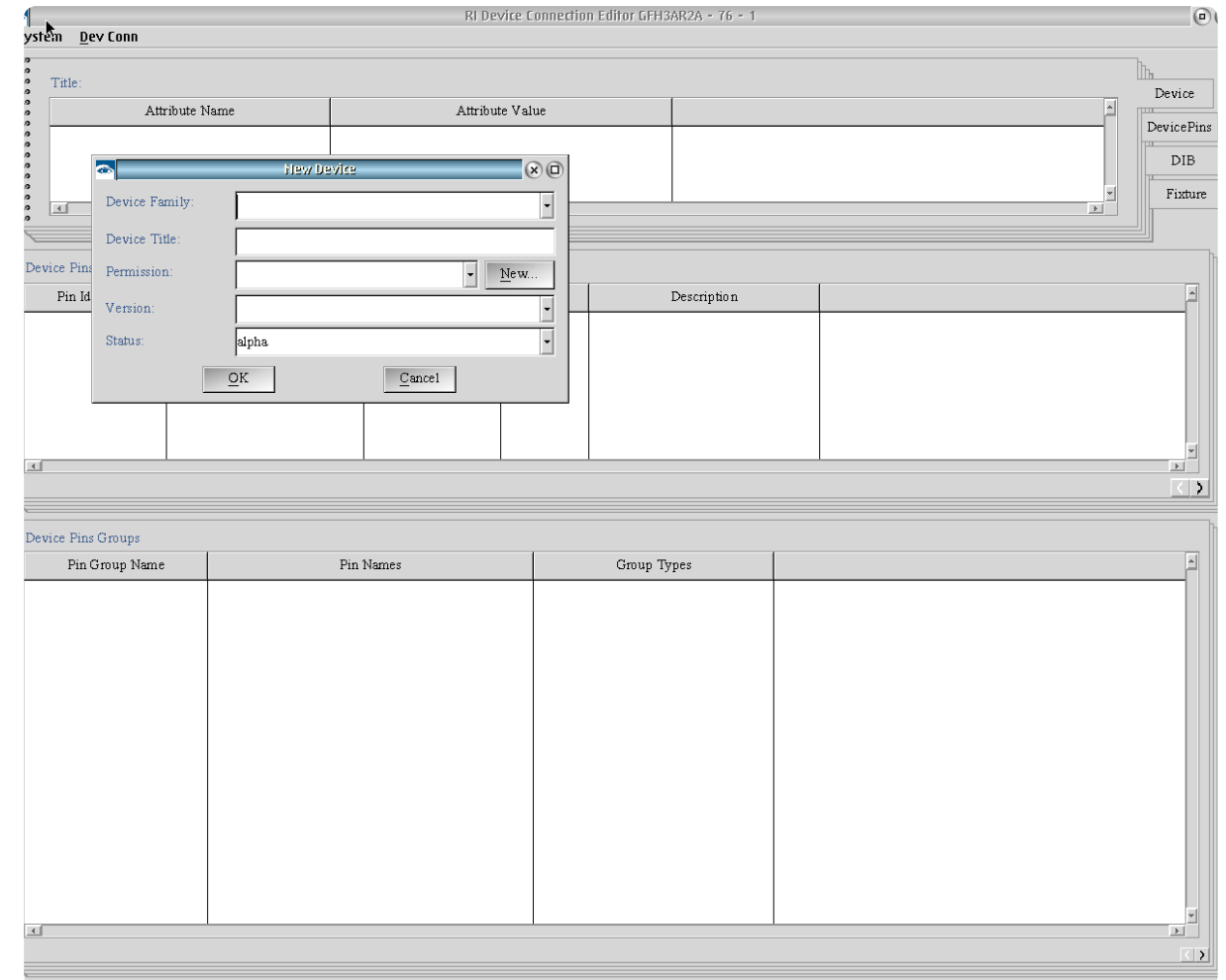
*Version* is a user-defined revision number such as 1.0, 1.1, etc.

*Status* is a drop down selection list of 'alpha', 'beta', or 'released' values. The 'alpha' and 'beta' values are intended for devices that are in stages of development. The 'released' attribute value is to designate that the object is ready for production and makes the Device definition read-only.

*NOTE: The 'released' attribute value prevents any further changes by disabling the Save menu options for the Device definition.*

4. Click OK to add the values to the **Device** attribute fields.

FIGURE 1.76 NEW DEVICE DEFINITION



#### To modify a Device attribute:

1. Highlight the entry by left clicking on the desired value in the attribute pane.
2. Right click on the selected entry and select **Edit** from the menu.
3. Click **OK** to save the changes to the Device attribute entry.

**To save changes to a Device definition:**

1. From the menu options select **Dev Conn > Save Device**
2. In the Save window, *Version* and *Status* attribute values can be modified to reflect changes.
3. Click **OK** to complete the save.

*NOTE: Each save creates a history of saved changes to the Device definition. Each saved version can be viewed from the 'History...' button in the Load Device window.*

**To save a new Device definition:**

1. From the menu options select **Dev Conn > Save Device As...**
2. In the Saving New Device window:

The *Device Title*, *Version*, and *Status* can be modified by the user.

A new *Device Family* can be selected from the drop down list of previously created attribute values.

The *Permission* can be selected from the drop down list of previously created attribute values or a new value can be created by clicking on the **New...** button.

3. Click **OK** to complete the save.

*NOTE: A Save As creates a new object history thread for the Device definition and does not retain the save history of the original Device definition.*

**To load a Device definition:**

1. From the menu options select **Dev Conn > Load...**
2. In the Device Selection window, the *Device Family* and *Permission* drop down lists can be used to narrow the search field by the attribute value.
3. Highlight the device by left clicking on the desired definition in the selection pane. The table can be resorted by any column by Right clicking anywhere and choose from the **Sort By** menu.
4. Click **OK** to load the latest version of the selected definition.

**To load a previously saved version of a Device definition:**

1. From the menu options select **Dev Conn > Load Device...**
2. Highlight the device by left clicking on the desired definition in the selection pane. The table can be resorted by any column by Right clicking anywhere and choose from the **Sort By** menu.
3. Click **History...** button to open the Object History window.

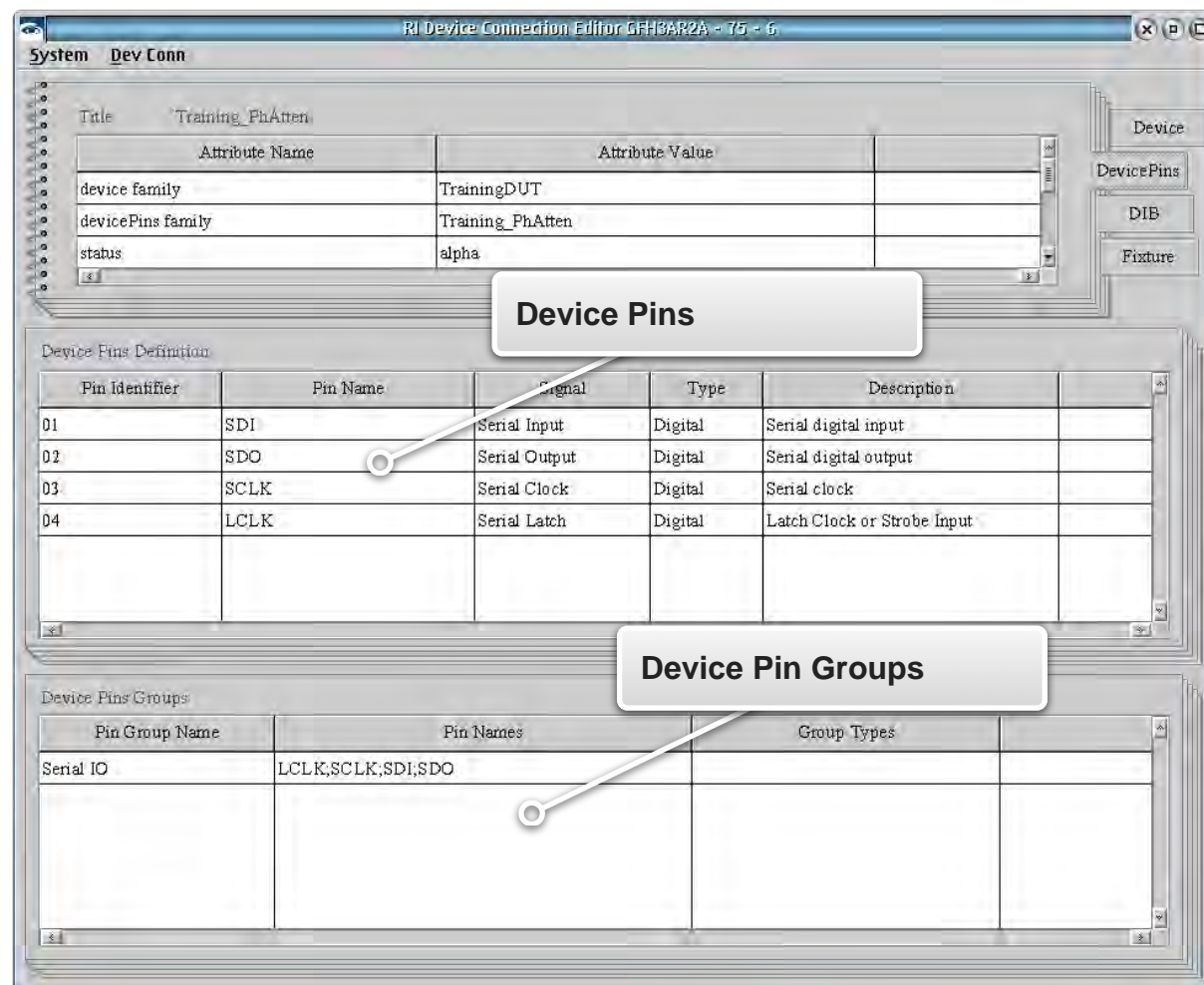
4. Select the desired version from the list of saved Device definitions.

*NOTE: Saving a previous version of the Device definition from the History creates a new save entry with the latest save timestamp. This version becomes the default definition on subsequent load requests.*

## DEVICE PINS DEFINITION

The Device Pins object or Device Pins Definition is accessed from the **Device Pins** tab and defines the port and pin resources of the created or selected device from the previous **Device** tab. This layer maps Cassini resources to device pins from the DIB and/or fixture. This layer in combination with the DIB and Fixture layers provides the ability to reassign Cassini instrument button parameters and values in

### INTERACTIVE 1.4 DEVICE PINS DEFINITION



the graphical programming environment with device pin naming conventions. The Device Pins definition consists of Attributes, Pins Definitions, and Pin Groups that are created and modified as described in the following text.

#### To create a new Device Pins:

1. From the menu options select **Dev Conn > New Device Pins...**
2. In the New Device Pins pop-up window fill in the attribute fields shown in [Figure 1.77](#) and listed below with their descriptions:

*Multiple Definitions* provides a 'Yes' or 'No' selection box for supporting pin identification across multiple sites. The default value is the 'No' selection.

*Device Pins Site* is used when the *Multiple Definitions* attribute is set to the 'Yes' selection. It provides a user-defined value or values to designate the site of corresponding pins by prefixing the pin value with the *Device Pin Site* value.

**NOTE:** If the *Multiple Definition* value is left in the default 'No' selection the *Device Pins Site* value should be left blank.

*Device Pins Family* is used to link the **Device Pins** and **DIB** layer objects in the Device Connection Editor for mapping resources from the target device pins to the device interface board pin/port designations. It is recommended to use a



generic *Device Pin Family* attribute value if multiple device designs or a family of devices will be supported.

*NOTE: This attribute is used to filter available definition selections in Load windows in the DIB tab to the currently loaded Device Pin Family.*

*Device Pins Title* is the user-specified name of the target device pins. In a family of devices it is used to identify a specific device pin variant or configuration.

*NOTE: The Device Pins Title value defaults to the Device Family value.*

*Device Family* provides a drop-down selection list of available attribute values created in the *Device* layer. These link the Device Pin definition to the target Device definition.

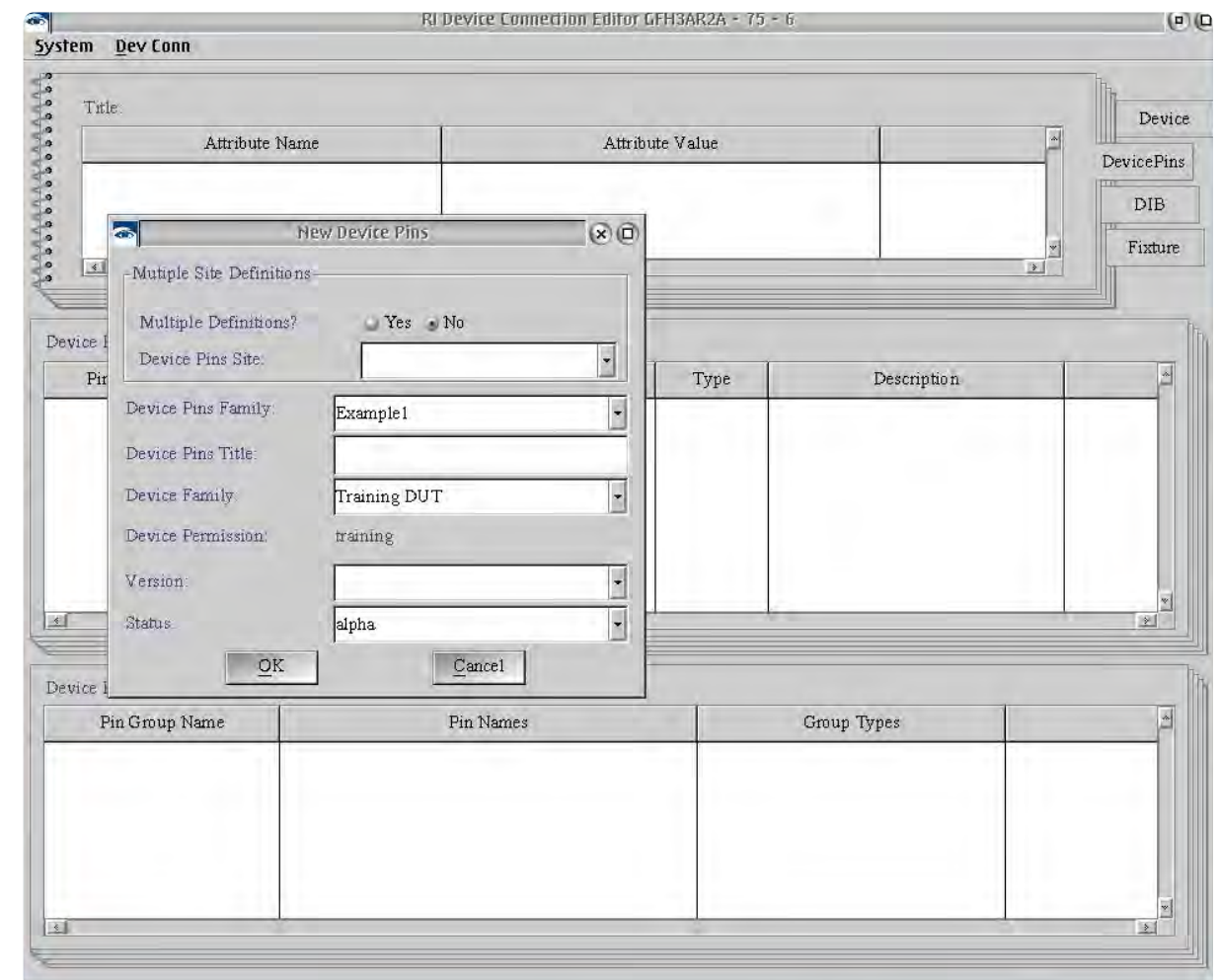
*NOTE: If a Device definition is loaded, the Device Family attribute will default to the Device layer attribute value in Device Pin saves.*

*Permission* is automatically assigned from the Permission attribute value of the loaded Device definition and cannot be altered in the New Device Pins window. It is a shared attribute value across related **Device**, **DIB**, and **Device Control** definitions (see [Figure 1.77](#)) that is also used for category

identification to narrow search results in Load windows for these layers in the Device Connection Editor.

*NOTE: Always load the target Device definition before creating a new Device Pins definition.*

FIGURE 1.77 NEW DEVICE PINS DEFINITION



*Version* is a user-defined revision number such as 1.0, 1.1, etc.

*Status* is a drop down selection list of 'alpha', 'beta', or 'released' values. The 'alpha' and 'beta' values are intended for devices that are in stages of development. The 'released' attribute value designates that it is ready for production and makes the *Device Pins* definition permanently read-only.

*NOTE: The 'released' attribute value prevents any further changes by disabling the Save menu options for the Device Pins definition.*

3. Click OK to add the values to the **Device Pins** attribute fields.

#### To modify a Device Pin attribute:

1. Highlight the attribute by left clicking in the selection pane.
2. Right click on the selected entry and select **Edit** from the menu.
3. Click **OK** to save the changes to the Device Pin attribute field.

#### To save changes to a Device Pins:

1. From the menu options select **Dev Conn > Save Device Pins**

2. In the Save window, *Version* and *Status* attribute values can be modified to reflect changes.
3. Click **OK** to complete the save.

*NOTE: Each save creates a history of saved changes to the Device Pins definition. Each saved version can be viewed from the 'History...' button in the Load Device Pins window.*

#### To save a new Device Pins:

1. From the menu options select **Dev Conn > Save Device Pins As...**
2. In the Saving New Device Pins window:

The *Device Pins Site*, *Device Pins Family*, *Device Pins Title*, *Version*, and *Status* can be modified by the user.

A new *Device Family* can be selected from the drop down list of previously created attribute values.

The *Permission* is automatically assigned from the Permission attribute value of the loaded Device definition and cannot be altered.

3. Click **OK** to complete the save.

*NOTE: A Save As creates a new history thread for the Device Pins definition and does not retain the save history of the original Device Pins definition.*

### To load a Device Pins:

1. From the menu options select **Dev Conn > Load Device Pins...**
2. In the Device Pins Selection window, the *Device Family* and *Device Pins Family* drop down list can be used to narrow the search field results by selecting an attribute value.
3. Highlight the device pins by left clicking on the desired definition in the selection pane. The table can be resorted by any column by Right clicking anywhere and choose from the **Sort By** menu.
4. Click **OK** to load the latest version of the selected definition.

### To load a previously saved version of a Device Pins:

1. From the menu options select **Dev Conn > Load Device Pins...**
2. Highlight the device pins by left clicking on the desired definition in the selection pane.
3. Click **History...** to open the Object History window.
4. Select the desired version from the list of saved **Device Pins** definitions.

*NOTE: Saving a previous version of the Device Pins definition from the History creates a new save entry with the latest save timestamp. This version becomes the default definition on subsequent load requests.*

## DEVICE PINS DEFINITION

The **Device Pins** tab has two panes below the attributes pane for defining the device pin and ports - Device Pins Definition and Device Pins Group.

The Device Pins Definition pane allows the user to input and describe the DUT pins in the Device Connection Editor.

*NOTE: Device Pin Definitions when used in conjunction with a DIB definition automatically rename individual TIM resources. For example, the Dpins instrument pins D1-1 through D1-20 are renamed with the user-specified Pin Name values.*

### To add a Device Pins Definition entry:

1. Right click on the Device Pins Definition pane and select **Add** from the menu.
2. Complete the entry form in the Add/Edit Device Pin window (see [Figure 1.78](#)) as described below:  
The *Pin Identifier* is commonly used to designate the pin number as specified on a data sheet.

The *Pin Name* is commonly used to designate the pin resource as specified on a data sheet.

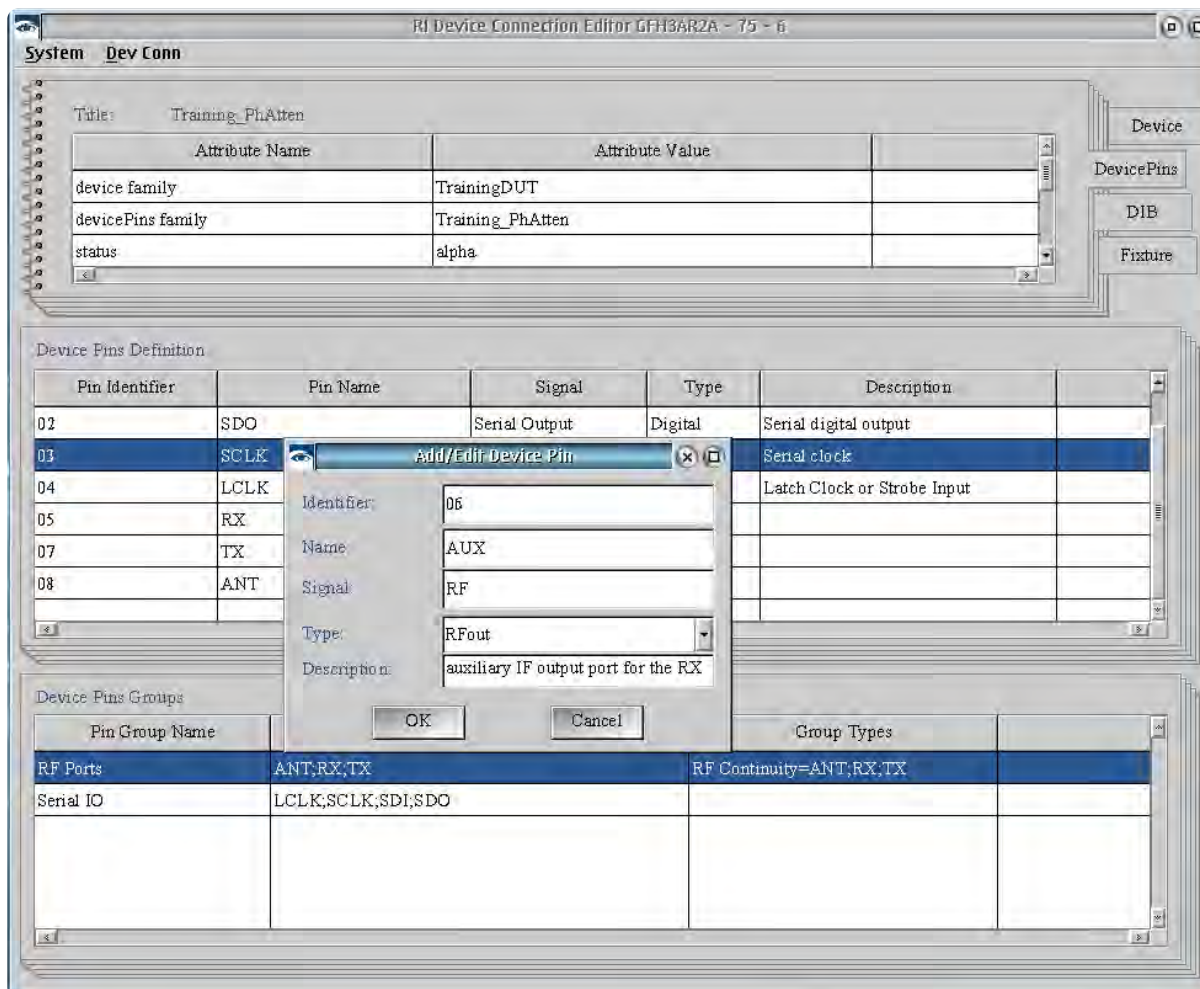
The *Signal* is a generic entry that is commonly used to designate the signal type, i.e - DC, digital, RF, etc.

The *Type* provides a drop-down list of selectable instrument resources on Cassini as well as allowing user-defined entries.

The *Description* provides additional information input about the pin resource.

*NOTE: The Pin Identifier and Pin Name entries are used as the connection resource for mapping DIB Path and DIB Resource Pins.*

FIGURE 1.78 ADDING A PIN DEFINITION



3. Click **OK** to add the entry to the Device Pin Definition field.

### To modify a Device Pins Definition entry:

1. Highlight the entry by left clicking on the desired definition in the Device Pins Definition pane.
2. Right click on the selected entry and select **Edit** from the menu.
3. Click **OK** to save the changes to the Device Pin Definition field.

**To copy a Device Pins Definition entry:**

1. Highlight the entry by left clicking on the desired definition in the Device Pins Definition pane.
2. Right click on the selected entry and select **Copy Row** from the menu.
3. Click **OK** to add the entry to the Device Pin Definition field.

The Device Pins Group pane allows the user to designate a set of pins with a user-defined name. This grouping convention can be used in the graphical programming environment to perform multi-pin measurements as a batch command or as communication pin designation with the RI8535 Digital TIM's *Dpins* instrument by using the **Pin State** button. (See [RI8535 Pin State button](#))

**To add a Device Pins Group entry:**

1. Right click on the Device Pins Group table form and select **Add** from the menu.
2. In the Device Pins Group window (see [Figure 1.79](#)) input a user-specified *Group Name* that is used to designate the pins in a group.
3. Left click on the desired pins in the Exclude Pin to select them. To unselect a pin, left click on the highlighted field.

*NOTE: The Exclude pin field is populated by Device Pin Definition entries.*

4. Click the **>>** button to add the selected resource to the Include Pin field. To remove a resource from the Include Pin field left click to select and click the **<<** button to move it back to the Exclude Pin field.
5. Click **OK** to add the entry to the Device Pins Group field.

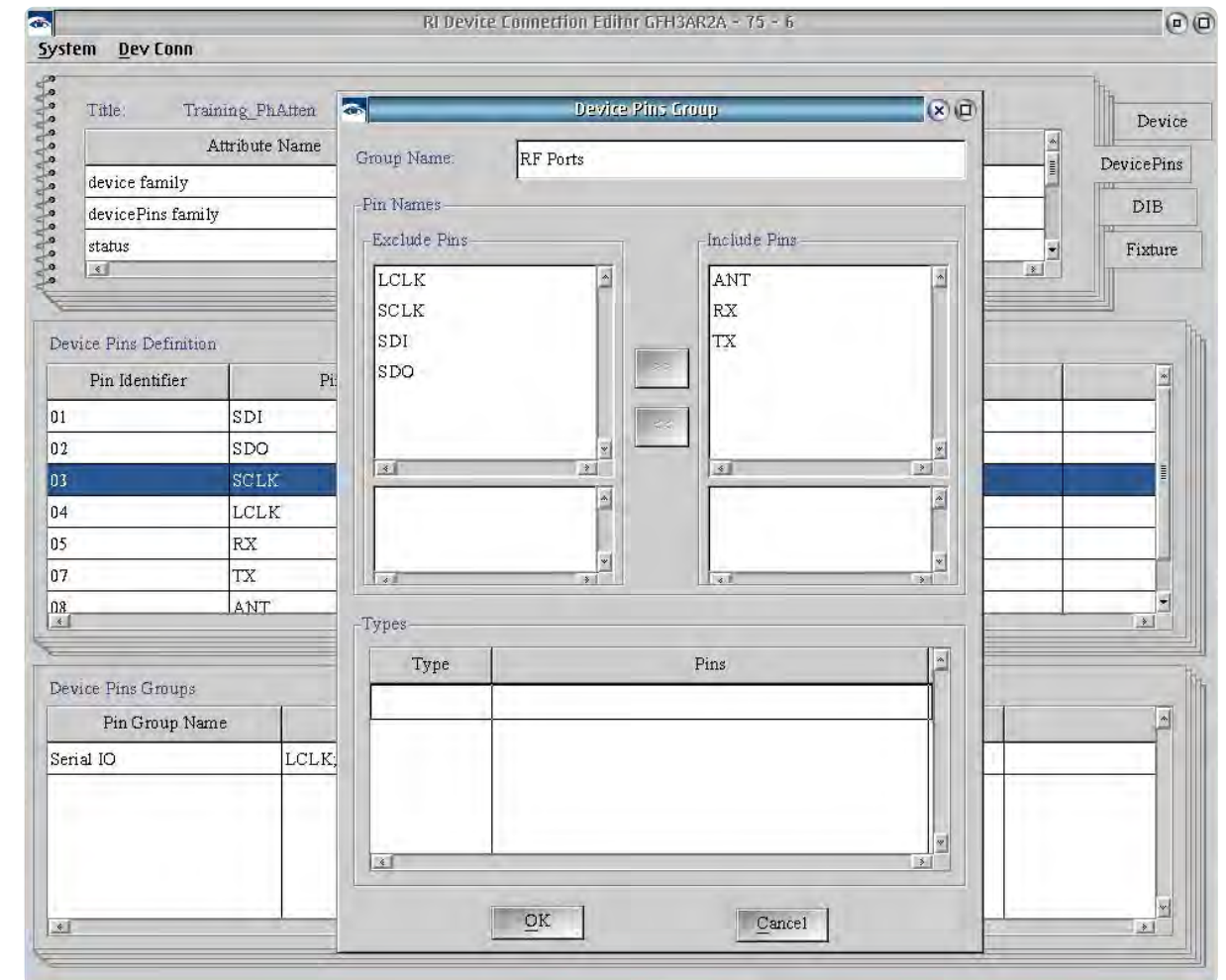


**To modify a Device Pins Group entry:**

1. Highlight the entry by left clicking on the desired definition in the table form.
2. Right click on the selected entry and select **Edit** from the menu.
3. Click **OK** to save the changes to the Device Pin Definition field.

**To copy a Device Pins Group entry:**

1. Highlight the entry by left clicking on the desired definition in the Device Pins Group table form.
2. Right click on the selected entry and select **Copy Row** from the menu.
3. Click **OK** to add the entry to the Device Pin Group field.

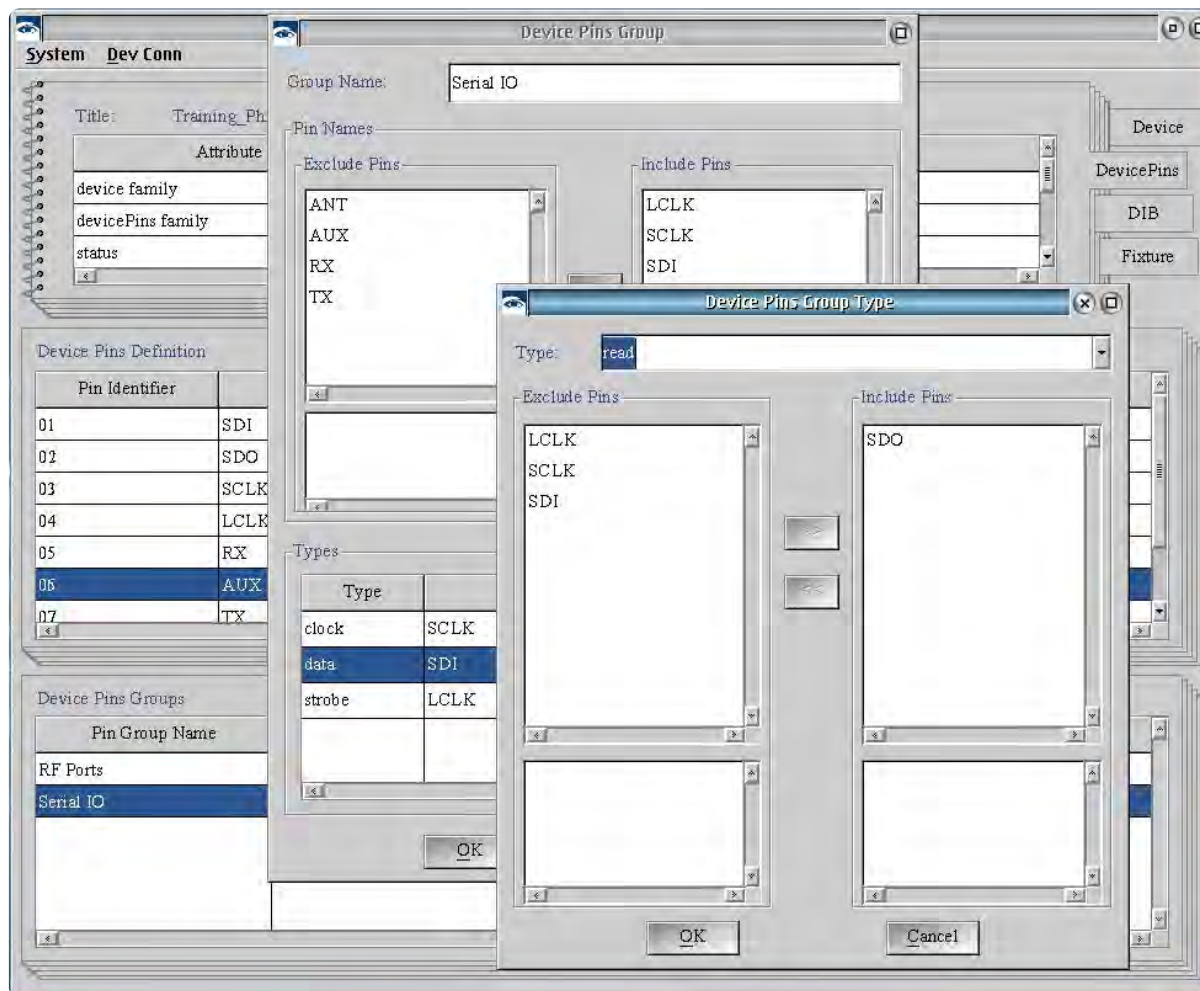
**FIGURE 1.79** ADDING A DEVICE PINS GROUP**Add Types to a Device Pins Group entry:**

Once a Device Pins Group has been created, pins within the group can be assigned a pin type. Types designate communication protocol resources such as clock, r/w, strobe, and scan pins in addition to specialized pin states such as open, off, and termination. Device pin groups with types are displayed as selection choices in the **Serial**

**Group** button of the RI8535 Digital TIM's Dpins instrument to designate serial or scan communication pin resources.

1. Highlight the Device Pins Group by left clicking on the desired entry in the Device Pins Group table row.
2. Right click on the selected entry and select **Edit** from the menu.

FIGURE 1.80 ADDING A DEVICE PINS GROUP TYPE



3. Right click on the Types field and select **Add** from the menu.
4. In the Device Pins Group Type window (see [Figure 1.80](#)), select a resource type from the drop-down box.
5. Left click on the desired pin or pins in the Exclude Pin list to select them. To unselect a pin, left click on the highlighted field.

*NOTE: The Exclude pin field is populated by Device Pin Definition entries.*

6. Click the >> button to add the selected resource to the Include Pin field. To remove a resource from the Include Pin field left click to select and click the << button to move it back to the Exclude Pin field.
7. Click **OK** to add the type for the selected pin or pins in the Device Pin Group.

## DIB (DEVICE INTERFACE BOARD) DEFINITION

The DIB object or DIB definition is accessed from the **DIB** tab (see [Interactive 1.5](#)) and defines the signal paths between the device pins and fixture resources on the PCB. This layer works in conjunction with the Device Pin and Fixture objects to reassign Cassini instrument button parameters and values in the graphical programming environment with device pin naming conventions. As well as providing pin/port mapping, the RF paths defined by the DIB represent a calibration layer that is cascaded with the fixture layer to extend scalar and vector error correction from the fixture signal launches to the device. The DIB definition consists of attributes, DIB paths, and DIB resource pins that are created and modified as described in the following text.

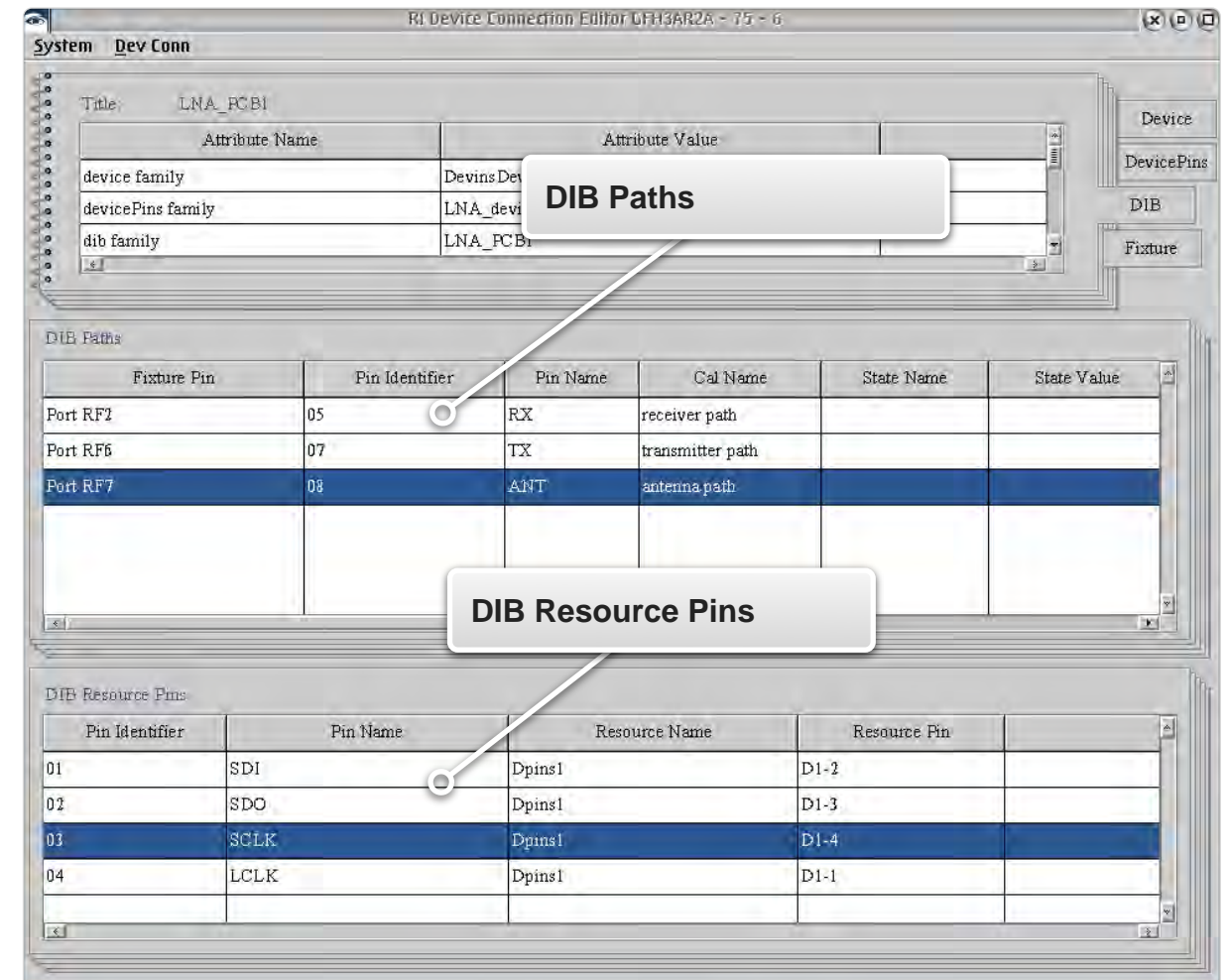
*NOTE: A Fixture Definition and Device Pins Definition must exist or be created before defining the resource connection in a DIB Definition.*

### To create a new DIB:

1. From the menu options select **Dev Conn > New DIB...**
2. In the New DIB pop-up window fill in the attribute fields that are listed below with their descriptions:

*DIB Family* provides a drop-down selection list of available attribute values and allows user input values used to identify a device interface board design or a family of board designs for a particular device. It is

## INTERACTIVE 1.5 DEVICE INTERFACE BOARD DEFINITION



recommended to use a generic *DIB Family* attribute value if multiple designs or a family of devices will be supported.

*DIB Title* is the user-specified name of the device interface board. In a family of DIBs it is used to identify a specific DIB version or design variant.

*NOTE: The DIB Title value defaults to the DIB Family value.*



*Device Family* provides a drop-down selection list of available attribute values created in the *Device* layer. These link the DIB definition to the target Device definition.

*NOTE: If a Device definition is loaded, the Device Family attribute will default to the Device layer attribute value in DIB saves.*

*Device Pins Family* provides a drop-down selection list of available attribute values created in the *Device Pins* layer. Is used to link the **Device Pins** and **DIB** layer objects in the Device Connection Editor for mapping resources from the target device pins to the device interface board pin/port designations.

*NOTE: This attribute is used to filter available definition selections in Load windows in the DIB tab to the currently loaded Device Pin Family.*

*Fixture Family* provides a drop-down selection list of available attribute values created in the *Fixture* layer. It is used to link the **Fixture** and **DIB** layer objects in the Device Connection Editor for mapping resources from the fixture signal launches to the device interface board pin/port designations.

*NOTE: If a Fixture definition is loaded, the value will default to the Fixture layer attribute value in DIB create/save windows.*

*Serial Number* is an automatically generated, unique alphanumeric identification number.

*NOTE: The user can input a specified value but it must be unique for each DIB definition.*

*Permission* is a shared attribute value across related Device, DIB, and Device Control definitions (see [Figure 1.75](#)) that is also used for category identification to narrow search results in load windows for these layers in the Device Connection Editor. If a fixture definition is loaded, the value will default to the Fixture layer attribute value in DIB create/save windows

*NOTE: The Permission attribute value of the DIB must match the Permission values of loaded Device, Device Pins, and Fixture definition in the Device Connection Editor.*

*Version* is a user-defined revision number such as 1.0, 1.1, etc.

*Status* is a drop down selection list of 'alpha', 'beta', or 'released' values. The 'alpha' and 'beta' values are intended for DIBs that are in stages of development. The 'released' attribute value designates that it is ready for production and makes the *DIB* definition read-only.

*NOTE: The 'released' attribute value prevents any further changes by disabling the Save menu options for the DIB definition.*

3. Click OK to add the values to the **DIB** attribute fields.

#### To modify a DIB attribute:

1. Highlight the entry by left clicking on the desired value in the attribute pane.
2. Right click on the selected entry and select **Edit** from the menu.
3. Click **OK** to save the changes to the DIB attribute field.

#### To save changes to a DIB definition:

1. From the menu options select **Dev Conn > Save DIB**
2. In the Save window, *Version* and *Status* attribute values can be modified to reflect changes.
3. Click **OK** to complete the save.

*NOTE: Each save creates a history of saved changes to the DIB definition. Each saved version can be viewed from the 'History...' button in the Load DIB window.*

#### To save a new DIB definition:

1. From the menu options select **Dev Conn > Save DIB As...**
2. In the Saving New DIB window:

The *DIB Family*, *DIB Title*, *Version*, and *Status* can be modified by the user.

The *Device Family*, *Device Pins Family*, and *Fixture Family* can be selected from the drop down list of previously created attribute values. The *Permission* can be selected from the drop down list of previously created attribute values or a new value can be created by clicking on the **New...** button.

3. Click **OK** to complete the save.

*NOTE: The 'Save As' creates a new history of changes thread for the DIB definition and does not retain the save history of the original DIB definition.*

#### To load a DIB definition:

1. From the menu options select **Dev Conn > Load DIB...**
2. In the DIB Selection window, the *Device Family*, *DIB Family*, *Fixture Family*, and/or *Device Pins Family* drop down list can be used to narrow the search field results by selecting an attribute value.
3. Highlight the DIB by left clicking on the desired definition.



- Click **OK** to load the latest version of the selected definition.

#### To load a previously saved version of a DIB definition:

- From the menu options select **Dev Conn > Load DIB...**
- Highlight the DIB by left clicking on the desired definition.
- Click **History...** to open the Object History window.
- Select the desired version from the list of saved DIB definitions.

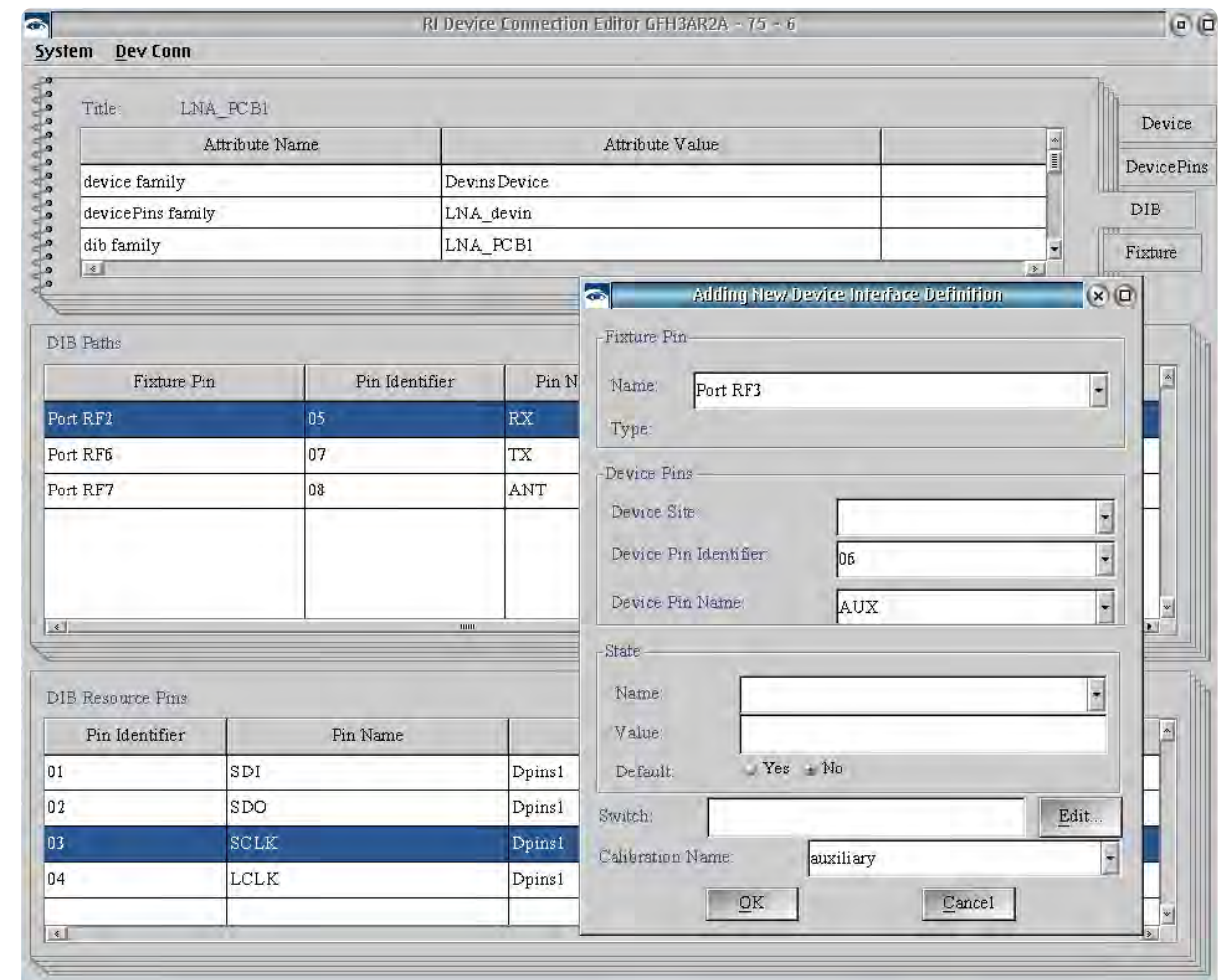
*NOTE: Saving a previous version of the DIB definition from the History creates a new save entry with the latest save timestamp. This version becomes the default definition on subsequent load requests.*

## DIB DEFINITION

The **DIB** tab has two panes below the attributes pane for defining the device interface board: DIB Paths and DIB Resource Pins.

DIB Paths define RF resource connections from the Device Pins to Fixture/TIM resource ports through the DIB. Paths provide calibration variable name entries that can apply error correction to compensate

FIGURE 1.81 ADDING A DIB PATH



for path loss in the DIB PCB and designate switch paths for controlling switch states on the DIB.

*NOTE: Each physical DIB PCB is identified by the Cassini software with a unique electronic serial number (ESN). This allows for each DIB PCB to have unique calibration data for each calibration path defined in the DIB definition.*

### To add a new DIB Path:

DIB Paths definitions must be unique:

- State *Name* and *Value* entry pairs cannot be repeated.
- *Calibration Name* entries must be unique for each path.
- Switched paths from the same *Fixture Pin* to the same *Device Pin* (fan-out/fan-in paths) must have unique *Switch* entries and State *Value* entries.

*NOTE: A Device Pins and Fixture definition must be loaded in the Device Connection Editor before defining DIB Paths.*

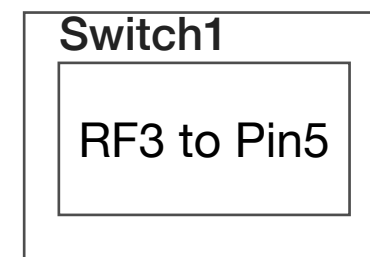
1. Right click on the DIB Path table form and select **Add** from the menu.
2. Complete the entry fields in the Adding New Device Interface Definition window (see [Figure 1.81](#)) for the *Fixture Pin*, *Device Pins*, *State*, *Switch* and/or *Calibration Name* described below:

The *Fixture Pin Name* provides a drop-down selection list of available fixture resources from the **Fixture** definition and allows user input values. These values define the fixture side resource connection of the DIB Path. New user entries in the *Fixture Pin Name* field of the **DIB** definition become available in the **Fixture** definition.

The Device Pins *Device Site*, *Device Pins Identifier*, and *Device Pins Name* provide drop-down selection list of the values available in the loaded Device/Device Pins definition. These values define the device side resource connection of the DIB Path.

The *State Name* and *Value* fields are used in conjunction with the *Switch* field to create a button for the graphical programming environment that represents the switch path state. The button owner is 'DIB' with the *Name* field as the button function and *Value* field defining the button parameter. See example below:

### DIB



Owner: DIB

State Name: Switch1

State Value: RF3 to Pin5

The *Switch* field contains the switch control/command string represented by the graphical button created from the *State Name* and *Value*. DIB switches are controlled via control bits supplied from the fixture. Consult the application notes for control bit (CBIT) command strings based on the module and fixture carrier type.

The *Calibration Name* provides a user-defined name for associating error correction with the designated path. For more information, see the [DIB Calibration](#) in this section.

3. Click **OK** to add the entry to the DIB path field.

*NOTE: Calibration data is applied automatically for the designated path when the DIB instrument is added to the [System Configuration](#).*

#### To modify a DIB Path entry:

1. Highlight the entry by left clicking on the desired path in the DIB Path pane.
2. Right click on the selected entry and select **Edit** from the menu.
3. Click **OK** to save the changes to the DIB Path field.

#### To copy a DIB Path entry:

1. Highlight the entry by left clicking on the desired definition in the DIB Path pane.
2. Right click on the selected entry and select **Copy Row** from the menu.
3. Click **OK** to add the entry to the DIB Path field.

DIB Resource Pins designate resource mapping on the DIB from a fixture/TIM resource to a device pin specified in the Device Pins tab. This resource mapping is used to rename the RI8535 Digital TIM's Dpins instrument button resources in the graphical programming environment (**D1-1** through **D1-20**, **D2-1** through **D2-20**, etc.) with the naming conventions defined by the user in the Device Pins Definition.

#### To add a new DIB Resource Pin:

DIB Resource Pins must be unique, the *Device Pin* and *Resource* entry pairs cannot be repeated.

*NOTE: A Device Pins and Fixture definition must be loaded in the Device Connection Editor before defining DIB Paths.*

1. Right click on the DIB Resource Pin pane and select **Add** from the menu.
2. Complete the entry fields in the Editing DIB Resource Connection window (see [Figure 1.82](#)) for the Device Pin and Resource Pin described below:

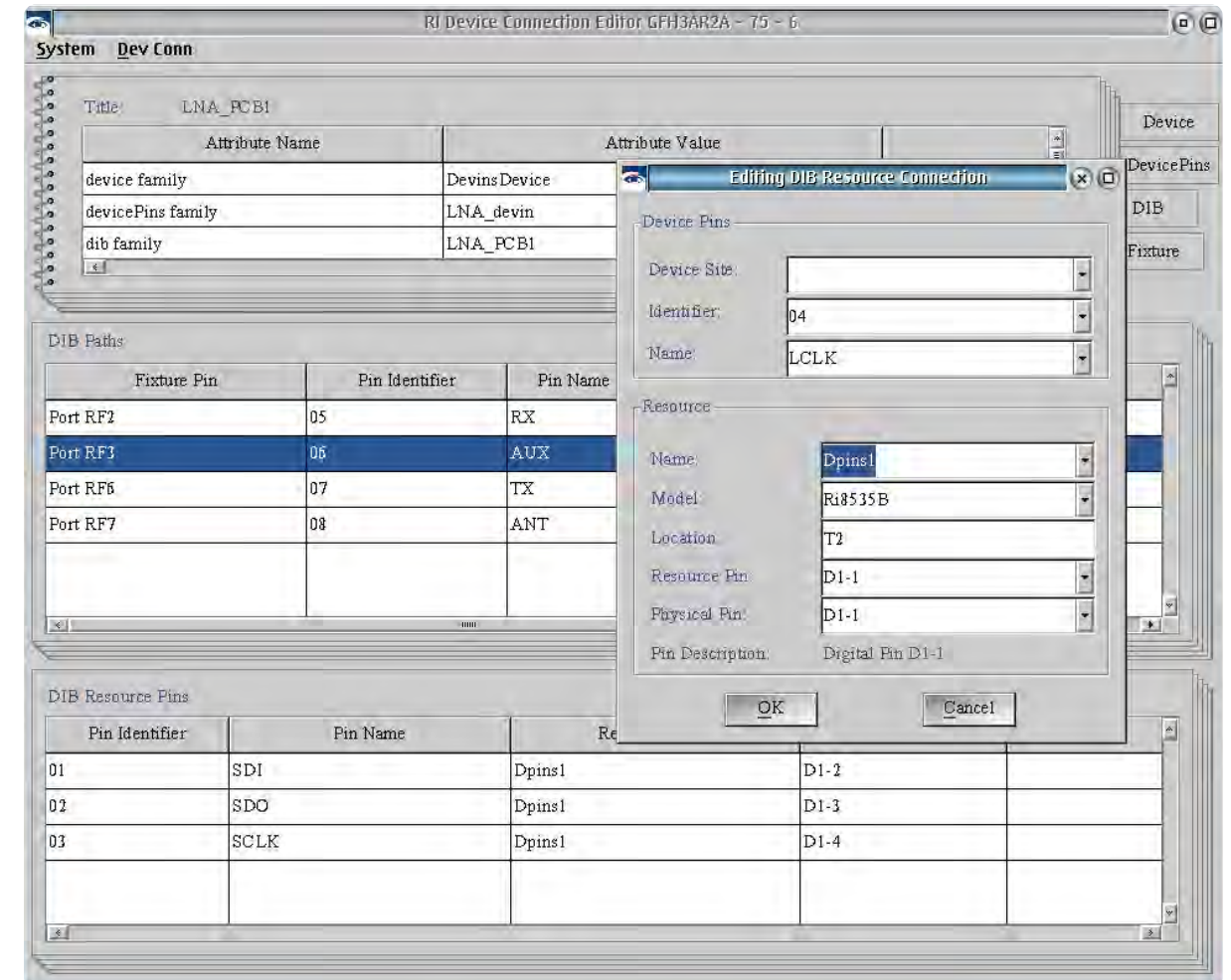
The *Device Pins Device Site*, *Identifier*, and *Name* are drop-down selections from the available resources in the loaded **Device Pin** definition. These values define the device side resource

connection.

The *Resource Name* provides a drop-down selection list of available instrument resources from the **Fixture** definition. The TIM resource *Model* and *Location* values available in the drop-down selections are defined by the tester configuration specified in the **Fixture** definition's *Tester* attribute. These values define the fixture side resource connection.

3. Click **OK** to add the entry to the DIB Resource Connection field.

FIGURE 1.82 ADDING A DIB RESOURCE PIN





**To modify a DIB Resource Pin entry:**

1. Highlight the entry by left clicking on the desired path in the DIB Resource Pins pane.
2. Right click on the selected entry and select **Edit** from the menu.
3. Click **OK** to save the changes to the DIB Resource Pin form.

**To copy a DIB Resource Pin entry:**

1. Highlight the entry by left clicking on the desired definition in the DIB Resource Pin table row.
2. Right click on the selected entry and select **Copy Row** from the menu.
3. Click **OK** to add the entry to the DIB Resource Pin field.

**DIB CALIBRATION**

When a *Calibration Name* is added to a *Fixture Path*, it creates a calibration variable that stores the calibration data associated with the RF path in the Fixture Definition. This extends error-corrected source and measurement capability to the DIB. When a 'Dut Instrument' with calibration data is added to the system configuration, all source amplitude settings and receiver measurements of the test system are relative to the calibration plane of the DIB, i.e - a source TIM power setting in the software/test plan of +1dBm is reflected as +1dBm at the calibration plane of the DIB. When any calibration variable associated with a *Fixture Path* is created, it has a default data type of *RiFrVs2pS* (frequency vs. 2-port s-parameter) and two data points: S11, S21, S12, and S22 at 1kHz and S11, S21, S12, and S22 at 20GHz. By default, the calibration data is linearly interpolated between any two successive data points to provide error correction for any value between the calibration endpoints.

*NOTE: Calibration data that has the Spline calculation button applied is saved as a *jbSpline* datatype and uses a second order polynomial interpolation between any two successive data points.*

**To view the default calibration data:**

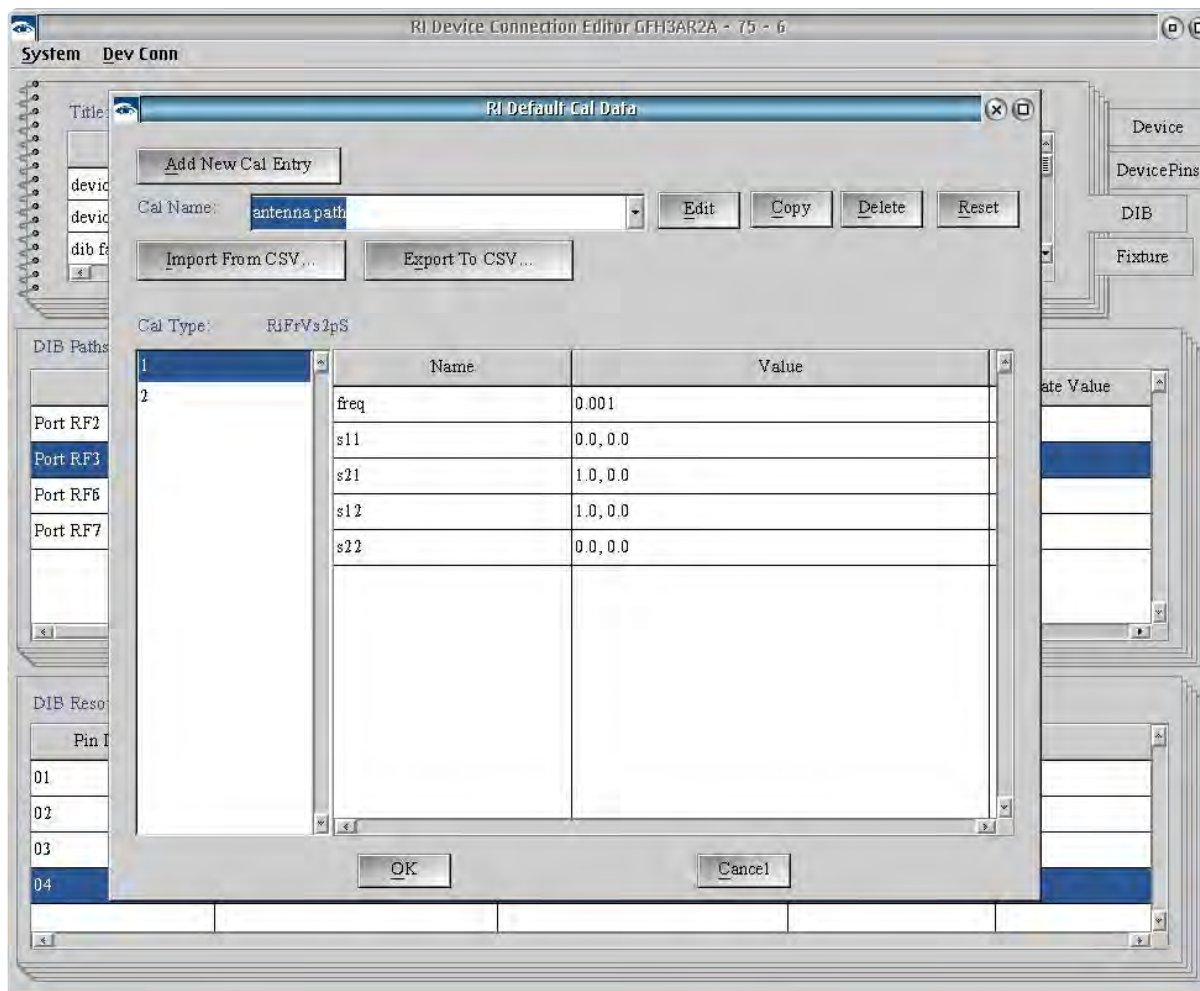
1. With the DIB tab selected in the Device Connection Editor, select **Dev Conn > Edit Default Cal...** from the menu options. The RI Default Cal window (see [Figure 1.83](#)) provides a drop-down list of



calibration variables created from DIB Paths and unassociated calibration variables.

2. Select a calibration name from the *Cal Name* drop down list.
3. The *Cal Type* fields will display the default data type of the selected calibration variable and display the number of data points

FIGURE 1.83 VIEW DIB DEFAULT CALIBRATION DATA



in the left pane with the associated values for a selected data point in the right pane.

#### To change the default calibration data type:

1. With the DIB tab selected in the Device Connection Editor, select **Dev Conn > Edit Default Cal...** from the menu options to open the RI Default Cal Window window (see [Figure 1.83](#)).
2. Select a calibration name from the drop down list.
3. The *Cal Type* fields will display the default data type of the selected calibration variable and display the number of data points in the left pane with the associated values for a selected data point in the right pane.

#### To add data points to the default calibration:

1. With the DIB tab selected in the Device Connection Editor, select **Dev Conn > Edit Default Cal...** from the menu options to access the RI Default Cal Window (see [Figure 1.83](#)).
2. In the left pane of the *Cal Type* fields right click and select **Add** from the menu.
3. In the Adding Cal Data Row window input the number of additional data points in the '*# of rows to add*' field and the

location of the new data points relative to the existing data points in the 'Starting index' field.

4. Click **OK** to add.

#### To remove a data point from the default calibration:

1. With the DIB tab selected in the Device Connection Editor, select **Dev Conn > Edit Default Cal...** from the menu options to access the RI Default Cal Window (see [Figure 1.83](#)).
2. In the left pane of the *Cal Type* fields right click on a datapoint to highlight it and select **Delete** from the menu.

In addition to calibration variables that are linked to DIB Paths, additional calibration variables can be added to the DIB Definition. When the 'Dut Interface' instrument is loaded into the [System Configuration](#), these unassociated calibration variables are available as calibration data in test plans.

#### To add a calibration variable:

1. With the DIB tab selected in the Device Connection Editor, select **Dev Conn > Edit Default Cal...** from the menu options to access the RI Default Cal Window (see [Figure 1.83](#)).
2. Click the **Add New Cal Entry** button.

3. In the New Cal Default window complete the fields listed below:

The *Cal Name* defines the new calibration variable designation.

*NOTE: Calibration variable names must be unique.*

The *Cal Type* field provides a drop-down list of data types to select for the calibration variable.

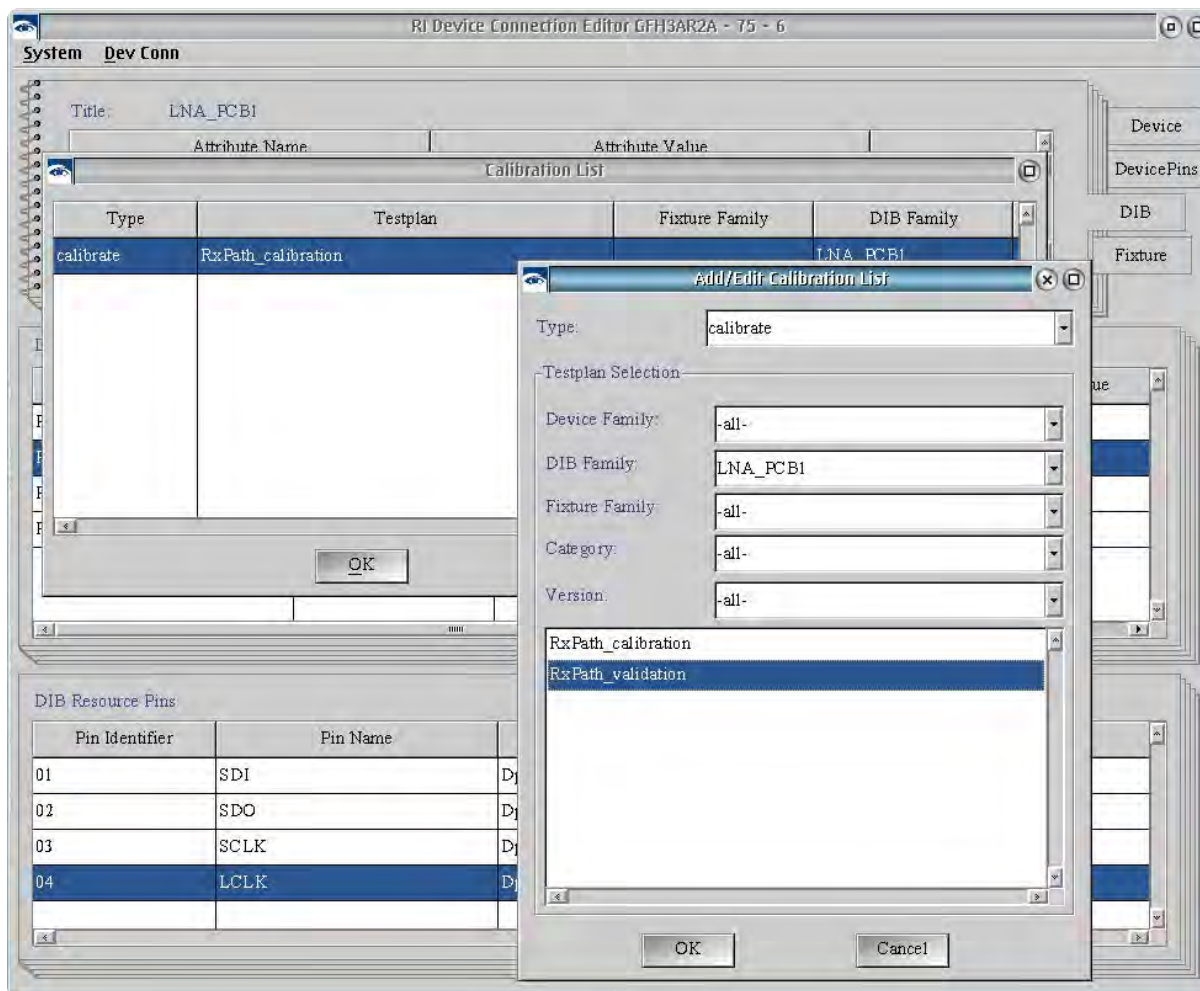
The *Data Size* defines the number of data points in the default calibration variable.

4. Click **OK** to add the calibration variable.

## DIB CALIBRATION LIST

The DIB Calibration List is a user-defined collection of test plans for performing a DIB calibration, verifying the calibration results, and DIB-specific diagnostics. This allows the user to define specific calibration methodologies and performance requirements for a DIB or a class of DIBs, and easily access the list directly from the 'Device Interface' instrument in the System Configuration window.

FIGURE 1.84 ADD/EDIT DIB CALIBRATION LIST



The following steps describe how to create DIB-specific calibration and diagnostic test plans from generic test plans and how to add these test plans to the DIB's calibration list to run them from a specialized calibration or diagnostic executive accessed from the right click **Calibration** menu on the 'Device Interface' instrument.

### Create DIB-specific calibration test plans:

*NOTE: Calibration variables associated with RF paths must first be created in a DIB Definition and the 'Dut Interface' instrument must be loaded into the System Configuration in order to access them in the graphical programming environment.*

1. Load a DIB definition with calibration paths and/or calibration variables into the System Configuration.

*NOTE: The DIB definition can be loaded manually by selecting Instrument > Add DIB Def... from the menu options in the [System Configuration Window](#) or docking a DIB to the fixture with the desired DIB definition.*

2. Open or create a new test plan by choosing **Test > Plans** from the main Cassini window.
3. Place a Cal Data input block in a test panel.  
DIB calibration data is written to the **Cal Data** input block in test plans. It is found in the **System > data saves** of the Editor Panel. See the [edit button descriptions](#) for more information.

4. Right click anywhere within the white space area contained by the **System** box that surrounds the gray **Cal Data** box and select **Change Owner** from the pop-up menu list.
5. From the list of available instruments in the system configuration, select **Dut Interface** from the pop-up menu list.
6. Right click anywhere within the gray **Cal Data** box and select **Cal Name...** from the pop-up menu list.
7. Select the desired DIB calibration variable with which to save measurement data.

*NOTE: Negative dB values are interpreted as path loss. The Cassini software will compensate by increasing signal input values of sources in the associated path or adding the path loss as a correction to measurements values for receive paths. Positive dB values are interpreted as path gain. The Cassini software will compensate by decreasing signal input values of sources in the associated path or subtracting the path gain correction from measurements values for receive paths.*

8. Save the test plan by selecting **File > Save Cal Test > Dib** from the menu options.
9. In the Save DIB Calibration Testplan window an additional 'dib' attribute can be added to the testplan. From the drop-down list select the *DIB Family* attribute for the desired **DIB Definition**.
10. Click **save** to finish.

#### To add a DIB calibration test plan to the Calibration List:

1. With the DIB tab selected in the Device Connection Editor, select **Dev Conn > Edit Cal List...** from the menu options.
2. In the Calibration List (see [Figure 1.84](#)) window, right click on the Calibration List pane and select **Add** from the menu to access the Add/Edit Calibration List window.
3. In the Add/Edit Calibration List window select 'calibrate' from the *Type* drop down list to add the selection to the Cal Exec list or 'diagnose' to add it to the Diag Exec list. The Testplan Selection form provides drop down lists for the Device Family, DIB Family, Fixture Family, Category, and Version attributes to narrow the list of displayed test plans. The 'verify' *Type* is not seen by either the Cal or Diag Execs from the System Configuration window.

*NOTE: Calibration and validation test plans should both use the Type: 'calibrate' selection when adding them to the Calibration List.*

4. Left click on the desired testplan in the list to select it and click **OK** to add it to the list.
5. Repeat the process to add multiple test plans to the list.

*NOTE: Test plans are displayed in the DIB Calibration Executive window in the order listed in the Calibration List.*



**Edit the order of test plans in the Calibration List:**

1. In the Calibration List window (see [Figure 1.84](#)) left click on a testplan in the form and then right click and select **Move Up** from the menu to change the location of the selected testplan to precede the testplan listed above it in the list.
2. Select **Move Down** from the right click menu to change the location of the selected testplan to follow the testplan listed below it in the list.
3. Select **Delete** from the right click menu to remove the selected testplan from the list.
4. Select **Dev Conn > Save DIB** from the window menu to save changes to the Calibration List in the DIB Definition.

**Open the DIB Calibration Executive or Diagnose Executive:**

1. Attach the DIB to the fixture and perform a [System Check](#) or [System Startup](#) to load the 'Dut Instrument' DIB Definition.
2. From the System Configuration window left click on the 'Dut Instrument' to highlight it in the list and then right click and select **Calibration > Calibrate** from the menu to open the Calibration Executive window. Select **Calibration > Diagnose** to open the Diagnostic Executive window.

3. The DIB calibration executive interface operates the same as the TIM calibration executive. Reference the [calibration procedure](#) for more information on using the calibration executive UI.



## LINK A DIB DEFINITION TO A DIB

A DIB Definition is linked to the physical hardware through Guru using a unique ID provided by an electronic serial number (ESN) chip loaded on the PCB and connected in line with the the S/N pins on the Fixture Carrier or FIX block. This ESN is used by Guru to identify and load unique calibration data for each specific DIB and by extension, the additional software resources (RF paths/pins, calibration variables, calibration list, and graphical programming buttons) specified by the DIB definition. Once the ESN is linked in Guru via the DIB's calibration object, the DIB definition resources are loaded automatically when the DIB and Fixture is docked to the test head and a [System Check](#) or [System Startup](#) is performed.

*NOTE: Device interface boards must include a unique Electronic Serial Number (ESN) provided by a 1-Wire bus compatible electronic serial number chip on the PCB. (i.e. Dallas Semiconductor Corp DS2401)*

### To link a DIB ESN to a DIB Definition:

1. Dock the DIB to the fixture and perform a [System Check](#).

*NOTE: If the DIB's serial number ID has not been associated to a DIB Definition previously, the Messages window will display a notification in red text that the serial number is not associated with any current definitions.*

2. In the [System Configuration Window](#) select **Instrument > Add DIB Def...** from the menu options.
3. Choose the desired DIB definition by left clicking to highlight it in the list and click the **Select** button. This will add a 'Dut Interface' instrument with the associated resources from the definition to the System Configuration.
4. Left click on the 'Dut Interface' instrument in the System Configuration list to highlight it and then right click and select **Calibration > Save** from the menu.

---

*CAUTION: If a DIB definition is updated in the Device Connection Editor, the currently loaded 'Dut Interface' instrument (DIB Definition) must be removed from the System Configuration and added again for the latest DIB definition to be loaded.*

---

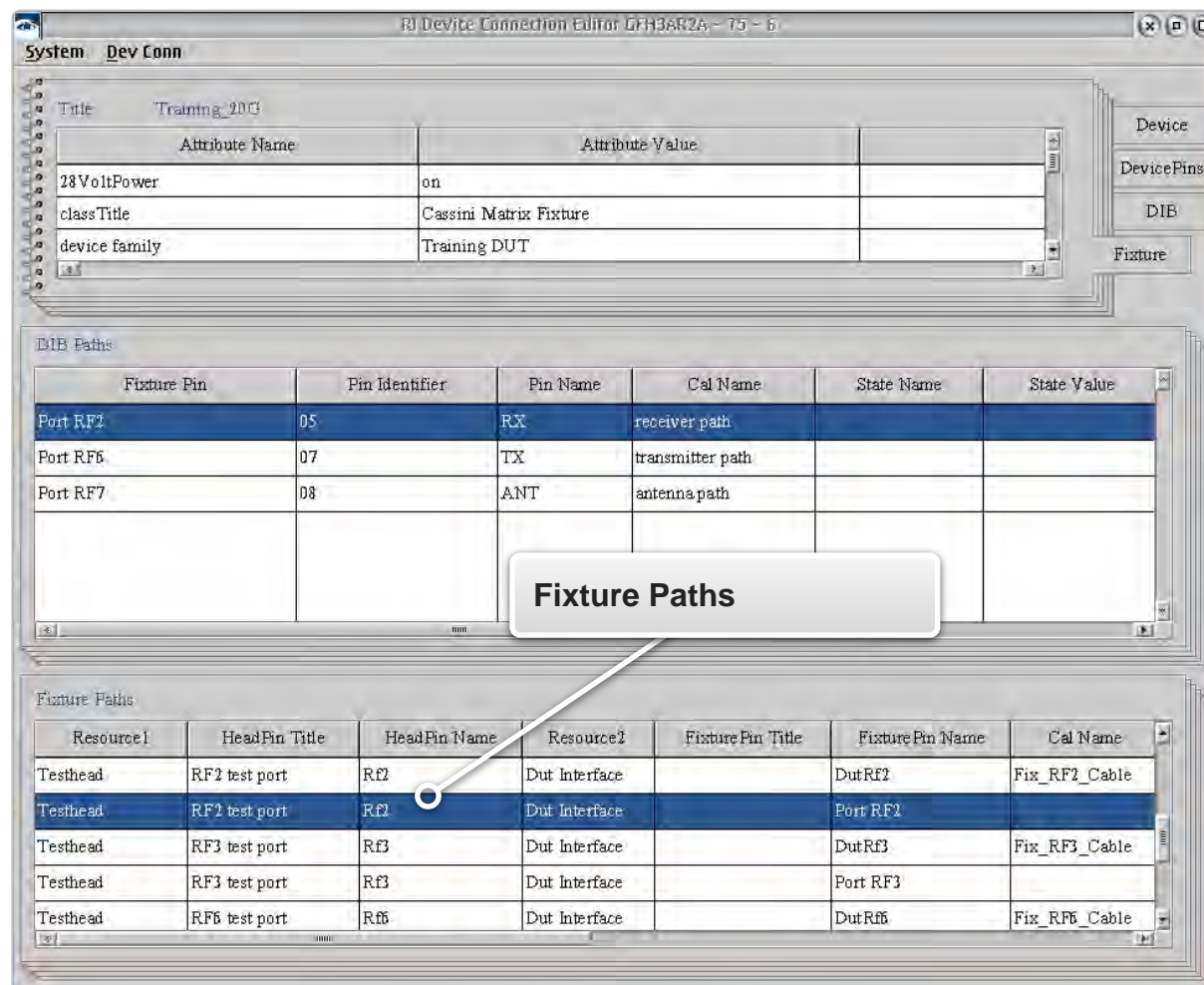
**View DIB Calibration Data:**

1. Dock the DIB to the fixture and perform a [System Check](#) or [System Startup](#) to load the 'Dut Instrument' resource.
2. From the System Configuration window left click on the 'Dut Instrument' to highlight it in the list and then right click and select **Calibration > Inspect** from the menu.
3. The Inspecting Cal Table displays the calibration variables in the left pane and the calibration data values in the right pane of selected variables.
4. Left click on the desired calibration variable in the left pane to highlight it in the list and then right click and select **View** from the menu to display the data in a plot window.

## FIXTURE DEFINITION

The Fixture object or Fixture Definition is accessed from the **Fixture** tab and defines RF instrument resource connections between TIMs and from TIM resources to the DIB interface signal launches. The RF paths between instruments define the tester's integration layer, allowing the test system to be dynamically reconfigured by a user-defined connections. These RF paths also represent a calibration layer

### INTERACTIVE 1.6 FIXTURE DEFINITION



that is cascaded with the RF TIMs to extend scalar and vector error correction from the TIM interface to the DIB signal launches. In addition, the fixture provides application extension through RIFL-controlled fixture instruments such as switches, relays, control/switch driver modules, and specialized digital/parametric measurement resources. The Fixture layer works in combination with the Device Pin and DIB definitions to provide the ability to reassign Cassini instrument button parameters and values in the graphical programming environment with device pin naming conventions. The Fixture definition consists of attributes and paths that are created and modified as described in the following text.

#### To create a new Fixture:

1. From the menu options select **Dev Conn > New Fixture...**
2. In the New Fixture pop-up window fill in the attribute fields that are listed below with their descriptions:

*Fixture Family* provides a drop-down selection list of available attribute values and allows user input values to identify a fixture design for a range of device applications or for a particular device. It is recommended to use a generic *Fixture Family* attribute value if multiple DIB designs or a family of devices will be supported. This attribute is used to link the **Fixture** and **DIB** layer objects in the Device Connection Editor for mapping resources from the fixture signal launches to the device interface board pin/port designations.

*Fixture Title* is the user-specified name of the fixture. In a family of fixtures it is used to identify a specific fixture version or application variant.

*NOTE: The Fixture Title value defaults to the Fixture Family value.*

The *Fixture Class Selection* provides a list of fixture carrier board types to define the selected hardware and software interfacing for controlling modules, fixture power, and RIFL communication with the fixture.

The *Interface* provides a drop-down list selection of PCB/firmware versions of the chosen *Fixture Class Selection* value based on the *Fixture Class Selection* attribute.

The *28 Volt Power* option provides a 'On' or 'Off' selection box for setting the default state of the 28V fixture power. The 28 volts is supplied from the Cassini test head RIFL block when the fixture is docked and checked into the System Configuration during a [System Check](#) or [System Startup](#). The supply is commonly used to power RF relays in the fixture.

*NOTE: The 28 Volt Power On/Off state can be set in a testplan using the Fixture 28V button found in the Editor Panel or set manually with a Control Panel under the Tester > state instrument settings.*

*Device Family* provides a drop-down selection list of available attribute values created in the *Device* layer. These link the Fixture definition to the target Device definition.

*NOTE: If a Device definition is loaded, the Device Family attribute will default to the Device layer attribute value in Fixture saves.*

The *Tester* selection provides a drop-down list of test system configurations. These configurations define the available TIM instruments and their TIM slot locations on the Cassini test head. This attribute is used to automate the resource selection and location menus when defining instrument connections in the Fixture Path field.

*NOTE: The tester configuration is displayed in the title bar of the [System Configuration Window](#).*

*Serial Number* is an automatically generated, unique alphanumeric identification number.

*NOTE: The user can input a specified value but it must be unique for each Fixture definition.*

*Permission* provides a drop-down list of previously created values that can be selected or a new value can be created by clicking on the

**New...** button. The Permission attribute is shared across related Device, DIB, and Device Control definitions (see [Figure 1.75](#)) that is also used for category identification to narrow search results in Load windows for these layers in the Device Connection Editor.

*NOTE: The Permission attribute value of the Fixture must match the Permission values of loaded Device, Device Pins, and DIB definitions in the Device Connection Editor.*

*Version* is a user-defined revision number such as 1.0, 1.1, etc.

*Status* is a drop down selection list of ‘alpha’, ‘beta’, or ‘released’ values. The ‘alpha’ and ‘beta’ values are intended for fixtures that are in stages of development. The ‘released’ attribute value designates that it is ready for production and makes the *Fixture* definition read-only.

*NOTE: The ‘released’ attribute value prevents any further changes by disabling the Save menu options for the Fixture definition.*

3. Click OK to add the values to the **Fixture** attribute fields.

#### To modify a Fixture attribute:

1. Highlight the entry by left clicking on the desired value in the attribute table form.
2. Right click on the selected entry and select **Edit** from the menu.
3. Click **OK** to save the changes to the Fixture attribute field.

#### To save changes to a Fixture Definition:

1. From the menu options select **Dev Conn > Save Fixture**
2. In the Save window, *Version* and *Status* attribute values can be modified to reflect changes.
3. Click **OK** to complete the save.

*NOTE: Each save creates a history of saved changes to the Fixture definition. Each saved version can be viewed from the ‘History...’ button in the Load Fixture window.*

#### To save a new Fixture Definition:

1. From the menu options select **Dev Conn > Save Fixture As...**
2. In the Saving New Fixture window:

The *Fixture Family*, *Fixture Title*, *Serial Number*, *Version*, and *Status* can be modified by the user.



*NOTE: The user can specify a Serial Number value but it must be unique for each Fixture definition.*

The *Fixture Class Selection*, *Interface*, *28 Volt Power*, *Device Family*, and *Tester*, can be selected from the drop down list of previously created attribute values.

The *Permission* can be selected from the drop down list of previously created attribute values or a new value can be created by clicking on the **New...** button.

3. Click **OK** to complete the save.

*NOTE: A Save As creates a new history of changes thread for the Fixture definition and does not retain the save history of the original Fixture definition.*

### To load a Fixture Definition:

1. From the menu options select **Dev Conn > Load Fixture...**
2. In the Fixture Selection window, the *Device Family* and Fixture drop down list can be used to narrow the search field results by selecting an attribute value.
3. Highlight the Fixture by left clicking on the desired definition in the form.
4. Click **OK** to load the latest version of the selected definition.

### To load a previously saved version of a Fixture Definition:

1. From the menu options select **Dev Conn > Load Fixture...**
2. Highlight the Fixture by left clicking on the desired definition in the table form.
3. Click **History...** to open the Object History window.
4. Select the desired version from the list of saved Fixture definitions.

*NOTE: Saving a previous version of the Fixture definition from the History creates a new save entry with the latest save timestamp. This version becomes the default definition on subsequent load requests.*

## FIXTURE DEFINITION

The **Fixture** tab has two table forms below the attributes field: DIB Paths and Fixture Paths. The DIB Paths display paths in a loaded DIB definition for reference purposes. Left clicking on the DIB Paths table will switch to the DIB tab for modifying paths or displaying DIB Resource Pins. The Fixture Paths define RF cable connections between TIM instruments on the bottom plate as well as to define

signal paths from TIM instruments to the DIB signal launches on the fixture top plate. The RF paths between instruments define Cassini's integration layer to define power meter, spectrum analyzer, and vector network analyzer virtual instruments. Signal paths from an instrument resource to the device interface can have calibration data associated with the path to provide scalar or vector error correction for path loss and/or mismatch in the fixture and designate switch paths for controlling switch states in the fixture.

FIGURE 1.85 ADD FIXTURE PATH

### To add a new Fixture Path:

Fixture paths must be unique:

- State *Name* and *Value* entry pairs cannot be repeated.
- *Calibration Name* entries must be unique for each path.
- Switched paths from the same *Fixture Pin* to the same *DIB/Resource 2* (fan-out/fan-in paths) must have unique *Switch* entries and *State Value* entries.

**NOTE:** A Device Pins and Fixture definition must be loaded in the Device Connection Editor before defining DIB Paths.

1. Right click on the Fixture Path table and select **Add** from the menu.

- Complete the entry fields in the Adding New Fixture Path Definition window (see [Figure 1.85](#)) for Resource 1 and Resource Pin1 described below:

*Resource Name1* provides a drop-down selection list of available instruments resources from the system configuration defined by the *Tester* attribute value.

The *Resource Model1* is the TIM model number of the selected instrument in the *Resource Name1* field.

*NOTE: The value is automatically selected from the entry in the Resource Name1 field and cannot be edited.*

The *Resource Location* is the TIM slot of the selected instrument in the *Resource Name1* field.

*NOTE: The Resource Location value is automatically selected from the entry in the Resource Name1 field as defined by the Tester attribute.*

The Physical Pin provides a drop-down selection list of available instruments resource ports for the selected instrument in the *Resource Name1* field.

The *Pin Title* is the name of the resource port of the selected instrument in the *Physical Pin* field as shown on block diagrams.

The *Pin Name* is the name of the resource port of the selected instrument in the *Physical Pin* field as referenced in buttons in the graphical programming environment.

*NOTE: If the selected instrument is a virtual instrument (NoiseFigure, VNA, DataSim) or contains only a single resource, i.e. - the RecLO or Pmeter, the Resource Pin1 fields are left blank.*

- Complete the entry fields in the Adding New Fixture Path Definition window for the DIB/Resource 2, DIB/Resource Pin2, and Pin Name described below:

*Resource Name2* provides a drop-down selection list of available instruments resources from the system configuration defined by the *Tester* attribute value and includes a 'Dut Interface' entry to designate a resource connection to the top plate signal launches for connecting to a DIB.

The *Resource Model2* is the TIM model number of the selected instrument in the *Resource Name1* field. If 'Dut Interface' is selected for the *Resource Name2* field, the *Resource Model2* field is left blank.

*NOTE: The Resource Model2 value is automatically selected from the entry in the Resource Name2 field and cannot be edited.*

The *Resource Location* is the TIM slot of the selected instrument in the *Resource Name2* field. If 'Dut Interface' is selected for the *Resource Name2* field, the *Resource Model2* field is left blank.

*NOTE: The Resource Location value is automatically selected from the entry in the Resource Name2 field as defined by the Tester attribute.*

The DIB/Resource Pin2 provides a drop-down selection list of available instruments resource ports for the selected instrument in the Resource Name2 field. If 'Dut Interface' is selected for the Resource Name2 field, the DIBResource Pin2 field is unavailable.

The Pin Title is the name of the resource port of the selected instrument in the Physical Pin field as shown on block diagrams. If 'Dut Interface' is selected for the Resource Name2 field, the DIB/Resource Pin2 field is unavailable.

The Pin Name provides a selection box with the options 'Create Default Pin' or to 'Enter/Select Name.' If the 'Create Default Pin' option is selected, the Pin Name uses the Default Name fields to generate a unique Pin Name. If the 'Enter/Select Name' option is selected, a user-defined name can be input in the Pin Name field.

*NOTE: If the selected instrument is a virtual instrument (NoiseFigure, VNA, DataSim) or contains only a single resource, i.e. - the RecLO or Pmeter, the DIB/Resource Pin2 fields are left blank.*

The Default Name fields provide top plate signal launch information to generate a unique Pin Name when the when 'Create Default Pin' is selected. The Block Type provides a drop-down selection of signal

launch types. The Block Number provides a drop down selection of launch locations on the top plate from 1 to 40. The Pin Number provides a drop-down selection of available pins based on the Block Type selection.

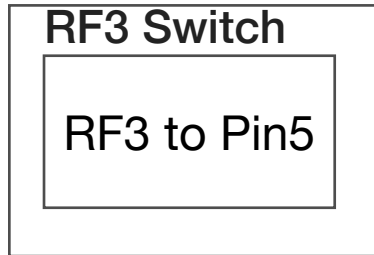
*NOTE: Entries in the Pin Name fields of the Fixture definition become available in the Fixture Pin Name drop-down selections in the DIB definition.*

- Complete the entry fields in the Adding New Fixture Path Definition window for the Fixture Site, State, Switch and/or Calibration Name described below:

The Fixture Site provides a user-defined site designation for repeated device or DIB Pin Names in a multi-site application.

The State Name and Value fields are used in conjunction with the Switch field to create a button for the graphical programming environment that represents a switch path state. The button owner is Fixture with the Name field being the button function and Value field defining the button parameter. See following example:

## Fixture



Owner: Fixture

State Name: RF3 Switch

State Value: RF3 to Pin5

The *Switch* field contains the switch control/command string represented by the graphical button created from the *State Name* and *Value*. The command string is dependent on the switch module and fixture carrier type. Consult the application notes for command strings based on the module and fixture carrier type.

The *Calibration Name* provides a user-defined name for associating error correction with the designated path.

---

**WARNING: Do not create Calibration Names for signal paths or resource connections between TIMs. These paths are calibrated as part of the tester's annual system calibration.**

---

The *Description* field provides an optional ascii input field for documentation purposes.

5. Click **OK** to add the entry to the Fixture Path field.

## Modify a Fixture Path entry:

1. Highlight the entry by left clicking on the desired path in the table form.
2. Right click on the selected entry and select **Edit** from the menu.
3. Click **OK** to save the changes to the Fixture Path field.

## Copy a Fixture Path entry:

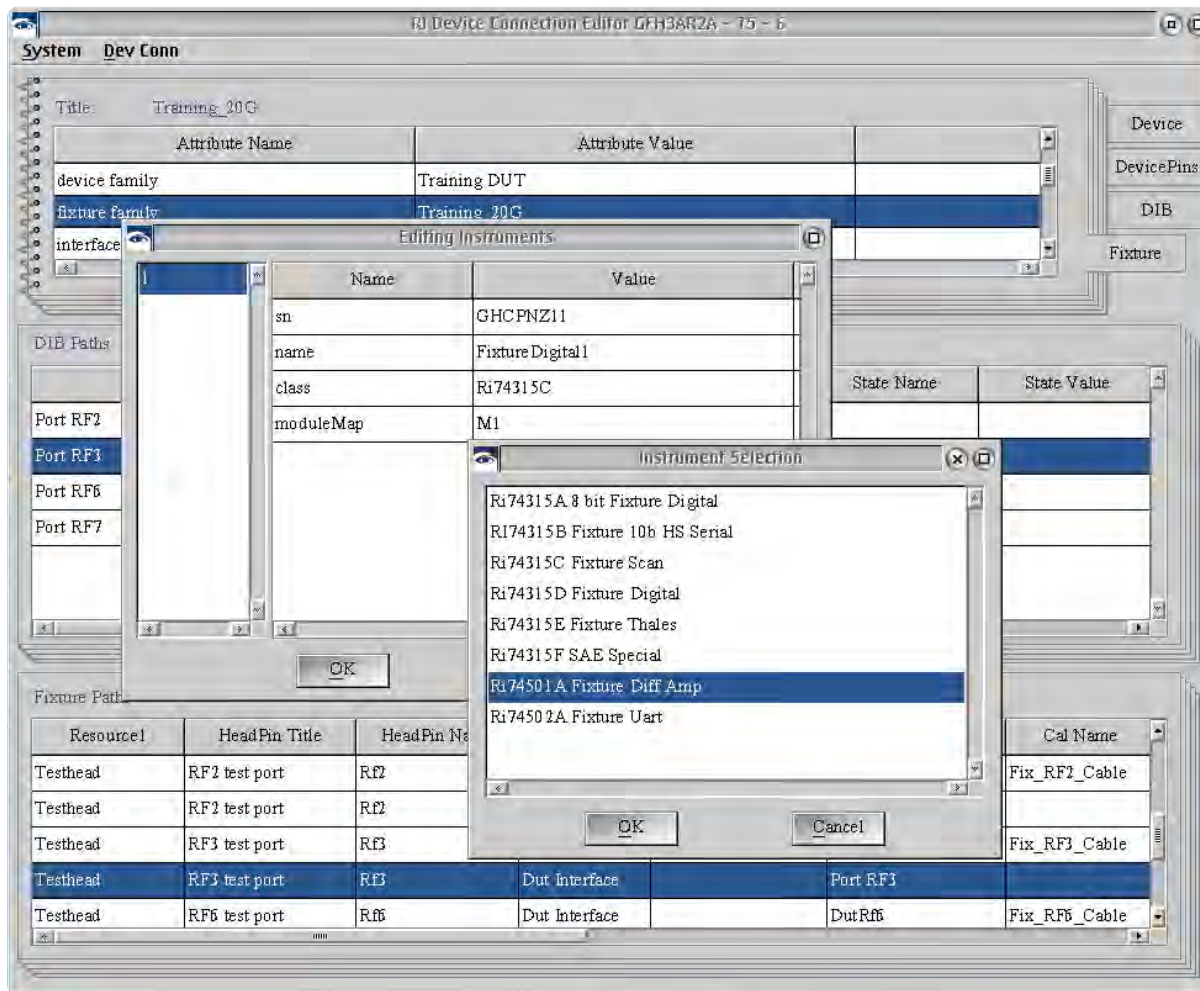
1. Highlight the entry by left clicking on the desired definition in the table form.
2. Right click on the selected entry and select **Copy Row** from the menu.
3. Click **OK** to add the entry to the Fixture Path field.



## FIXTURE INSTRUMENTS

A fixture instrument or multiple fixture instruments can be assigned to a fixture definition. The firmware and software resources of these fixture instruments are loaded when the fixture is docked and a [System Check](#) or [System Startup](#) is performed. The fixture instrument is added to the System Configuration and the associated buttons and/or measurement blocks are accessible in the graphical

FIGURE 1.86 ADD FIXTURE INSTRUMENT



programming environment through the Editor Panel in the 'Fixture' instrument.

### To add an instrument to the fixture:

1. From the menu options select **Dev Conn > Edit Instrument...**  
The Edit Instruments window (see [Figure 1.86](#)) is divided into two panes. The Left pane lists all loaded fixture instruments as a numbered list and the right pane displays information about instruments selected in the right pane.
2. Right click in the left pane and select **Add** from the menu.
3. In the Instrument Selection window (see [Figure 1.86](#)) left click on the desired instrument and click **OK** to add.  
The right pane displays the fixture instrument information:  
*SN* displays the unique, alphanumeric identification number of the fixture instrument.  
*Name* displays the designation of the fixture instrument in the software (System Configuration, Editor/Control Panels).  
*Class* displays the fixture instrument model number.  
*moduleMap* displays the location of the fixture instrument on the fixture carrier PCB.

*NOTE: Fixture instruments connect to module locations in the fixture for power and RIFL communication.*

4. In the right pane, left click on the *moduleMap* to highlight it, right click and select **Edit** from the pop-up menu.
5. Select the module location from the drop-down list to match the physical module location of the fixture instrument on the carrier PCB and select **OK** to save the new location.
6. Click **OK** in the Editing Instruments window to save all changes.

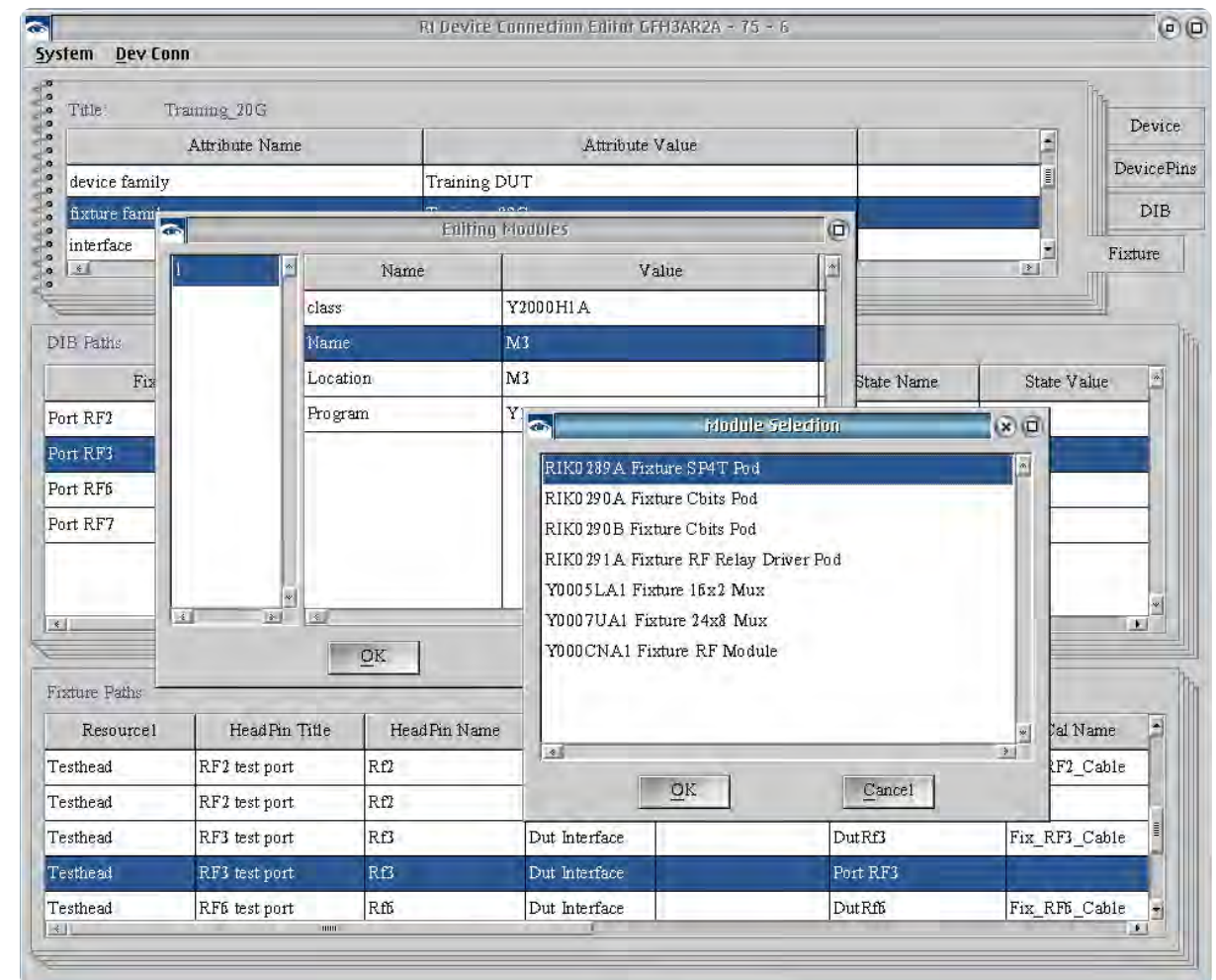
#### To remove a fixture instrument from the Fixture definition:

1. From the menu options select **Dev Conn > Edit Instruments...** to access the Edit Instruments window (see [Figure 1.86](#)).
2. In the left pane, left click on the fixture instrument to highlight it, right click and select **Delete** from the menu.

## FIXTURE MODULES

A fixture module or multiple fixture modules can be assigned to a fixture definition. The firmware and software resources of fixture modules are loaded when the fixture is docked and a [System Check](#) or [System Startup](#) is performed. Fixture modules provide signal switching, control bits, relay/switch drivers, and mux resources that are controlled by the *Switch* command values in the Fixture Path.

FIGURE 1.87 ADD FIXTURE MODULE



**To add a module to the Fixture definition:**

1. From the menu options select **Dev Conn > Edit Modules...**  
The Edit Modules window (see [Figure 1.87](#)) is divided into two panes. The Left pane lists all loaded Modules as a numbered list and the right pane displays information about modules selected in the right pane.
2. Right click in the left pane and select Add from the menu.
3. In the Module Selection window left click on the desired module and click **OK** to add. The right pane will now display the module information:  
*Class* displays the module type.  
*Name* displays the designation of the module in the software.  
*Location* displays the location of the module on the fixture carrier PCB.

*NOTE: Consult the [online](#) application notes for module command strings.*

4. In the right pane, left click on the Location to highlight it, right click and select **Edit** from the menu.
5. Select the module location from the drop-down list to match the physical module location on the fixture carrier PCB and select **OK** to save the new location.
6. Click **OK** in the Editing Modules to save all changes.

**To remove a module from the Fixture definition:**

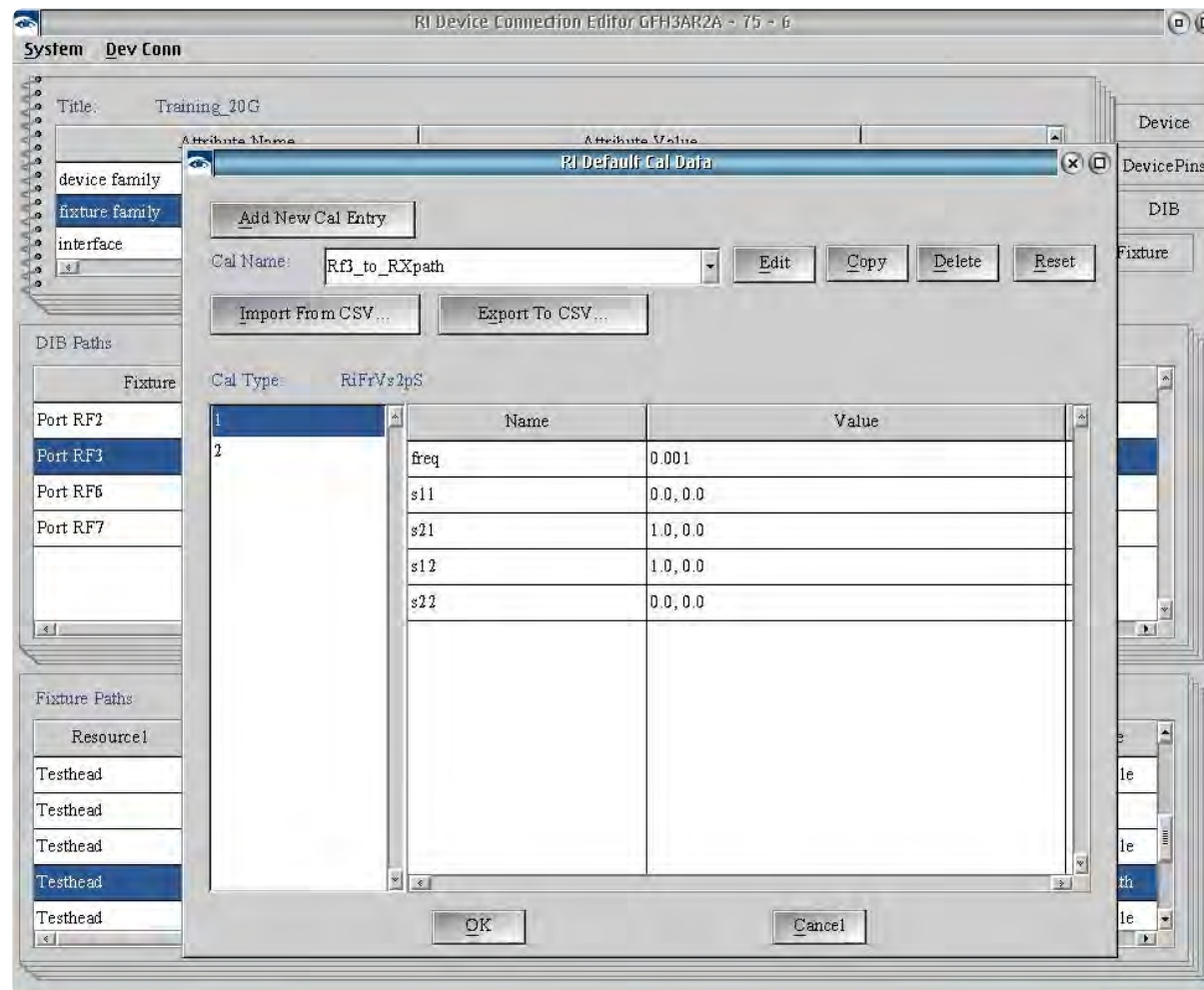
1. From the menu options select **Dev Conn > Edit Modules...** to access the Edit Modules window (see [Figure 1.87](#)).
2. In the left pane, left click on the module to highlight it, right click and select **Delete** from the menu.



## FIXTURE CALIBRATION

When a *Calibration Name* is added to a *Fixture Path*, it creates a calibration variable that stores the calibration data associated with the RF path in the Fixture Definition. This extends error-corrected source and measurement capability to the fixture. When the 'Fixture' instrument is added to the system configuration, all source TIM amplitude settings and receiver measurements are relative to the

FIGURE 1.88 EDIT FIXTURE DEFAULT CALIBRATION



calibration plane of the Fixture, i.e - a source power setting in the software/test plan of +1dBm is reflected as +1dBm at the calibration plane of the fixture. When any calibration variable associated with a *Fixture Path* is created, it has a default data type of *RiFrVs2pS* (frequency vs. 2-port s-parameter) and two data points: S11, S21, S12, and S22 at 1kHz and S11, S21, S12, and S22 at 20GHz. By default, the calibration data is linearly interpolated between any two successive data points to provide error correction for any value between the calibration endpoints.

*NOTE: Calibration data that has the Spline calculation button applied is saved as a *jbSpline* datatype and uses a second order polynomial interpolation to compute values between any two successive data points.*

### To view the default calibration data:

1. With the Fixture tab selected in the Device Connection Editor, select **Dev Conn > Edit Default Cal...** from the menu options. The RI Default Cal window (see [Figure 1.88](#)) provides a drop-down list of calibration variables created from Fixture Paths and unassociated calibration variables.
2. Select a calibration name from the *Cal Name* drop down list.
3. The Cal Type fields will display the default data type of the selected calibration variable and display the number of data points in the left pane with the associated values for a selected data point in the right pane.

**To change the default calibration data type:**

1. With the Fixture tab selected in the Device Connection Editor, select **Dev Conn > Edit Default Cal...** from the menu options to access the RI Default Cal Window window (see [Figure 1.88](#)).
2. Select a calibration name from the drop down list.
3. The *Cal Type* fields will display the default data type of the selected calibration variable and display the number of data points in the left pane with the associated values for a selected data point in the right pane.

**To add data points to the default calibration:**

1. With the Fixture tab selected in the Device Connection Editor, select **Dev Conn > Edit Default Cal...** from the menu options to access the RI Default Cal Window (see [Figure 1.88](#)).
2. In the left pane of the *Cal Type* fields right click and select Add from the menu.
3. In the Adding Cal Data Row window input the number of additional data points in the '*# of rows to add*' field and the location of the new data points relative to the existing data points in the '*Starting index*' field.
4. Click **OK** to add.

**To remove a data point from the default calibration:**

1. With the Fixture tab selected in the Device Connection Editor, select **Dev Conn > Edit Default Cal...** from the menu options to access the RI Default Cal Window (see [Figure 1.88](#)).
2. In the left pane of the *Cal Type* fields right click on a datapoint to highlight it and select **Delete** from the menu.

In addition to fixture path calibration variables, additional calibration variables can be added to the Fixture Definition. When the Fixture instrument is loaded into the System Configuration, these unassociated calibration variables are available as calibration data in test plans.

**To add a calibration variable:**

1. With the Fixture tab selected in the Device Connection Editor, select **Dev Conn > Edit Default Cal...** from the menu options to access the RI Default Cal Window (see [Figure 1.88](#)).
2. Click the **Add New Cal Entry** button.
3. In the New Cal Default window complete the fields listed below:

The *Cal Name* defines the new calibration variable designation.

*NOTE: Calibration variable names must be unique.*



The *Cal Type* field provides a drop-down list of data types to select for the calibration variable.

The *Data Size* defines the number of data points in the default calibration variable.

4. Click **OK** to add the calibration variable.

## FIXTURE CALIBRATION LIST

The Fixture Calibration List is a user-defined collection of test plans for performing Fixture calibration, verifying the calibration results, and Fixture-specific diagnostics. This allows the user to define specific calibration methodologies and performance requirements for a fixture or a class of fixtures, and easily access the list directly from the 'Fixture' instrument in the System Configuration window.

The following steps describe how to create Fixture-specific calibration test plans from generic test plans and how to add these calibration plans to the Fixture's calibration list to run them from a specialized calibration or diagnostic executive window accessed from the **Calibration** menu when right clicking on the 'Device Interface' instrument.

### Create fixture-specific calibration test plans:

*NOTE: Calibration variables associated with RF paths must first be created in a fixture definition and the 'Fixture' instrument must be loaded into the System Configuration in order to access them in the graphical programming environment.*

1. Load a fixture definition with calibration paths and/or calibration variables into the System Configuration.

*NOTE: The fixture definition can be loaded manually by selecting Instrument > Add Fixture Def... from the menu options in the [System Configuration Window](#) or docking a fixture with the desired fixture definition.*

2. Create or open a new test plan.
3. Place a Cal Data input block in a test panel. Fixture calibration data is written to the **Cal Data** input block in test plans. It is found in the **System > data saves** of the Editor Panel. See the [edit button descriptions](#) for more information.
4. Right click anywhere within the white space area contained by the **System** box that surrounds the gray **Cal Data** box and select **Change Owner** from the menu list.
5. From the list of available instruments in the system configuration, select **Fixture** from the menu.
6. Right click anywhere within the gray **Cal Data** box and select **Cal Name...** from the pop-up menu list.
7. Select the desired calibration variable with which to save measurement data.

*NOTE: Negative dB values are interpreted as path loss. The Cassini software will compensate by increasing signal input values of sources in the associated path or adding the path loss as a correction to measurements values for receive paths. Positive dB values are interpreted as path gain. The Cassini software will compensate by decreasing signal input values of sources in the associated path or subtracting the path gain correction from measurements values for receive paths.*

8. Save the test plan by selecting **File > Save Cal Test > Fixture** from the menu options.
9. In the Save Fixture Calibration Testplan window an additional *Fixture* attribute can be added to the testplan. From the drop-down list select the *Fixture Family* attribute for the desired **Fixture Definition**.
10. Click **save** to finish.

#### **Add a fixture calibration test plan to the Calibration List:**

1. With the Fixture tab selected in the Device Connection Editor, select **Dev Conn > Edit Cal List...** from the menu options.
2. In the Calibration List window right click anywhere on the Calibration List pane and select **Add** from the menu to access the Add/Edit Calibration List window.
3. In the Add/Edit Calibration List window (see [Figure 1.89](#)) select 'calibration' from the *Type* drop down list. The Testplan Selection fields provide drop down lists for the Device Family, DIB Family, Fixture Family, Category, and Version attributes to narrow the search field results of displayed test plans.

*NOTE: Calibration and validation test plans both use the Type: 'calibration' when adding them to the Calibration List.*

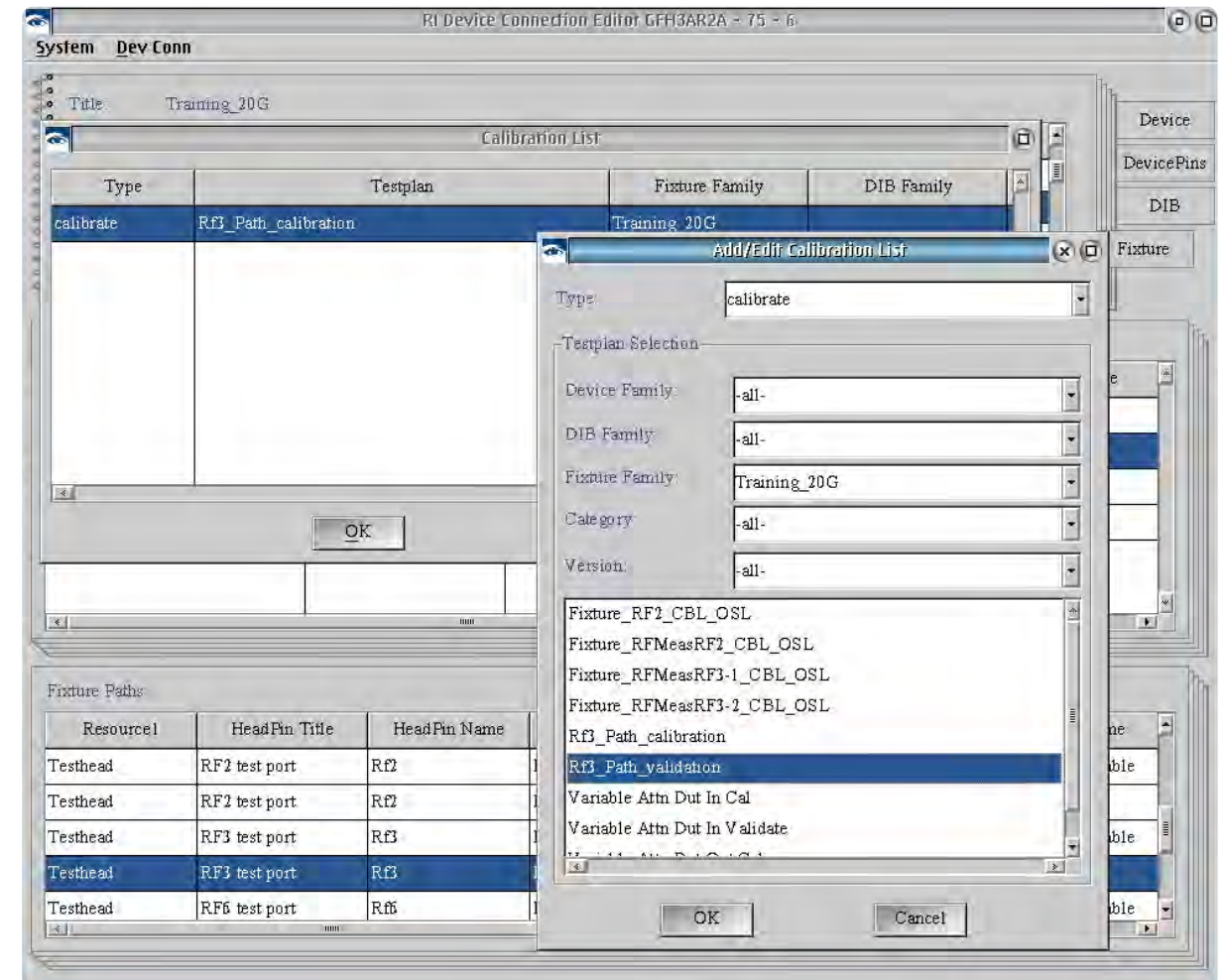
- Left click on the desired testplan in the list to select it and click **OK** to add it to the Calibration List.
- This process is repeated to add multiple calibration test plans to the list.

*NOTE: Calibration test plans are displayed in the fixture calibration executive in the order listed in the Calibration List.*

#### Edit the order of test plans in the Calibration List:

- In the Calibration List window (see [Figure 1.89](#)), right click an entry and select **Move Up** from the menu to change the location of the selected testplan to precede the testplan listed above it in the list.
- Select **Move Down** from the right click menu to change the location of the selected testplan to follow the testplan listed below it in the list.
- Select **Delete** from the right click menu to remove the selected testplan from the list.
- Select **Dev Conn > Save Fixture** from the Device Connection Editor window menu to save changes to the Calibration List in the Fixture Definition.

FIGURE 1.89 EDIT FIXTURE CALIBRATION LIST



**Access the Fixture Calibration List Executive:**

1. Dock the fixture and perform a [System Check](#) or [System Startup](#) to load the Fixture instrument.
2. From the System Configuration window, left click on the Fixture to highlight it in the list and then right click and select **Calibration > Calibrate** from the menu to open the Calibration Executive.
3. The fixture Calibration Executive interface operates the same as the TIM Calibration Executive. Reference the [calibration procedure](#) for more information on using the calibration executive UI.

**LINKING A FIXTURE DEFINITION TO A FIXTURE**

A fixture definition is linked to the fixture hardware through Guru using a unique electronic serial number chip ID. This serial number is used by Guru to identify and recall unique calibration data for each specific fixture and by extension, the additional software resources (RF paths, TIM interconnections, calibration variables, calibration list, and graphical programming buttons) in the fixture definition. Once the serial number ID is linked in Guru, the fixture definition resources are loaded automatically when the fixture is docked to the test head and a [System Check](#) or [System Startup](#) is performed.

*NOTE: Pod fixtures generate a unique alphanumeric ID in the fixture carrier's onboard programmable array logic chip.*

*Matrix fixtures generate a unique alphanumeric ID with an electronic serial number chip on the fixture carrier's PCB.*

*Calibration/diagnostic plates generate a unique alphanumeric ID with an electronic serial number chip attached to the RIFL bottom plate block.*

**To program a fixture definition to a fixture:**

1. Dock the fixture to the test head and perform a [System Check](#).

*NOTE: If the fixture's serial number ID has not been programmed with a Fixture Definition previously, the Messages window will display a notification in red text that the serial number is not associated with any current definitions.*

2. In the [System Configuration Window](#) select **Instrument > Add Fixture Def...** from the menu options.
3. Choose the desired fixture definition by left clicking to highlight it in the list and click the **Select** button. This will add a Fixture instrument with the associated resources from the definition to the system configuration.
4. Left click on the Fixture instrument in the System Configuration list to highlight it and then right click and select **Calibration > Save** from the menu.

---

**CAUTION:** *If a fixture definition is updated in the Device Connection Editor, a currently loaded Fixture instrument (Fixture Definition) must be removed from the System Configuration and checked back in for the latest fixture definition to be loaded.*

---

**To view fixture calibration data:**

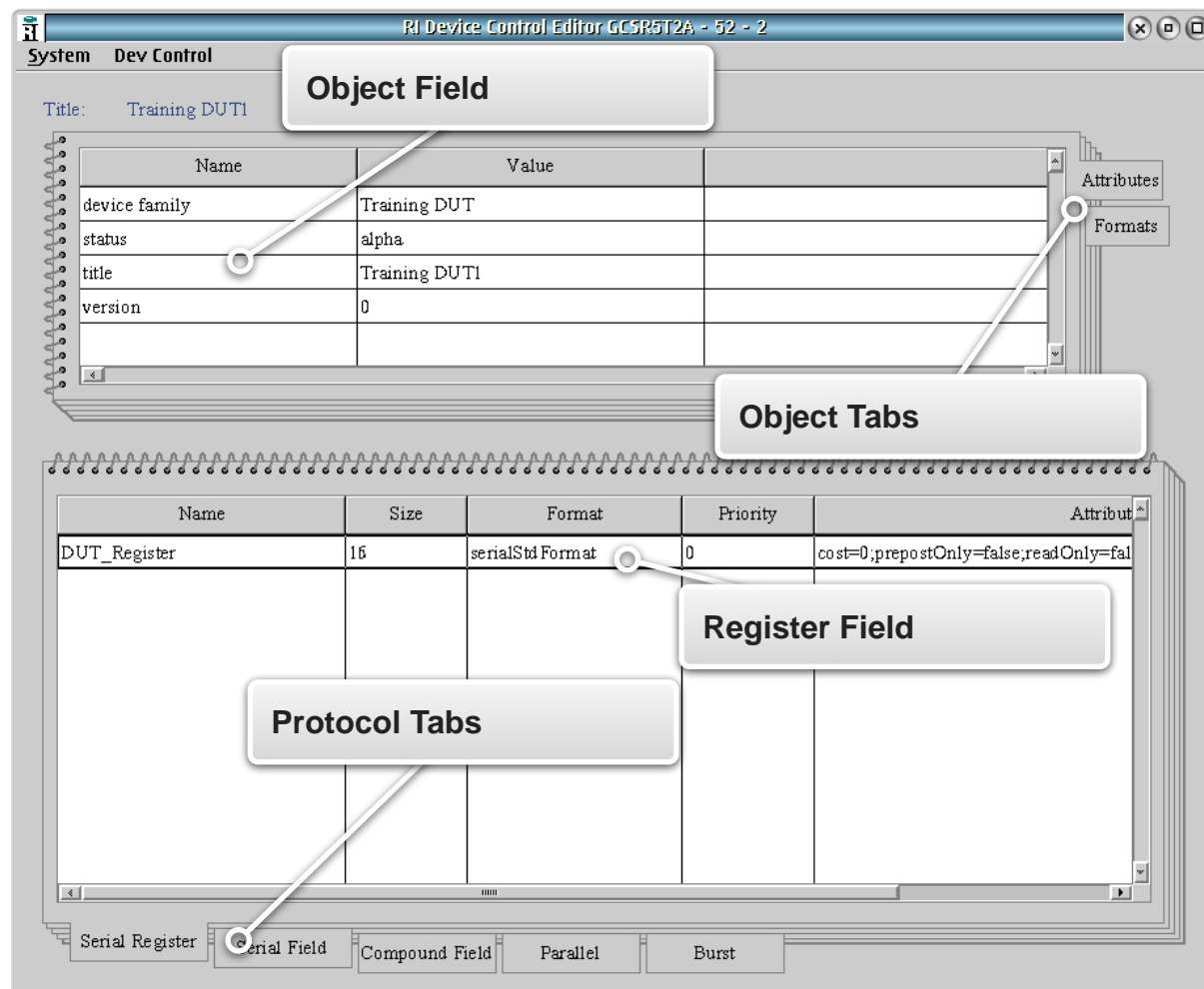
1. Dock the fixture and perform a [System Check](#) or [System Startup](#) to load the Fixture instrument. The fixture RF paths and associated calibration data are mapped to their connected TIM instrument resources.
2. From the System Configuration window left click on the Fixture to highlight it in the list and then right click and select **Calibration > Inspect** from the menu.
3. The Inspecting Cal Table displays the calibration variables in the left pane and the calibration data values in the right pane of selected variables.
4. Left click on the desired calibration variable in the left pane to highlight it in the list and then right click and select **View** from the menu to display the data in a plot window.

*NOTE: Negative dB values are interpreted as path loss. The Cassini software will compensate by increasing signal input values of sources in the associated path or adding the path loss as a correction to measurements values for receive paths. Positive dB values are interpreted as path gain. The Cassini software will compensate by decreasing signal input values of sources in the associated path or subtracting the gain values from measurements values for receive paths.*



# DEVICE CONTROL EDITOR

## INTERACTIVE 1.7 DEVICE CONTROL EDITOR



## TOPICS

[Introduction](#)

[User Interface](#)

[Device Control Definition](#)

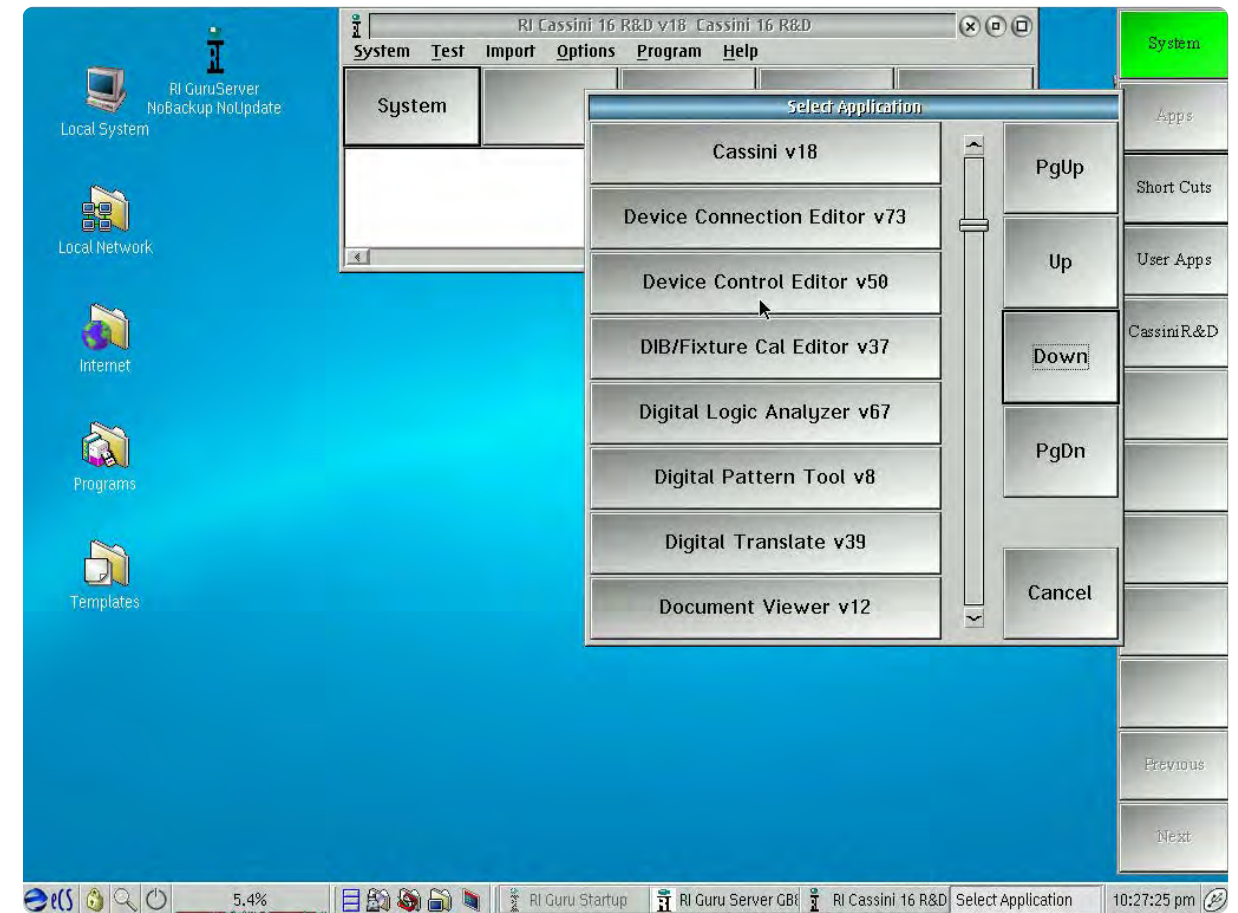
[DUT Instrument](#)

## INTRODUCTION

The Device Control Editor creates a software object that defines the communication protocol, register structure, and bit strings of a device under test. This Device Control Definition is used to create protocol aware buttons of a [DUT instrument](#) in the graphical programming environment that represent registers or groups of registers. This allows the user to develop and maintain device controls for a family of similar parts or successive generations with new features, registers, or control bits separate from the test plan development environment. The resultant software object can then be linked to a Device Definition to integrate the control definition with the target device under test created in the [Device Connection Editor](#). The following text describes:

- The Device Control Editor user interface
- How to define the digital communication protocol and register structure
- How to link the Device Control Definition to a Device Definition

FIGURE 1.90 ACCESSING THE DEVICE CONTROL EDITOR



The Device Control Editor can be found in the Cassini Apps list as shown above.

## USER INTERFACE

The Device Control Editor is divided into two editable panels each with tabs that provide their corresponding with contextual input fields, see [Figure 1.91](#).

The upper panel contains the Attributes and Formats tabs with values that apply to the Device Control Definition.

The upper panel defines values that apply to all settings in the Device Control Definition, with the descriptions below:

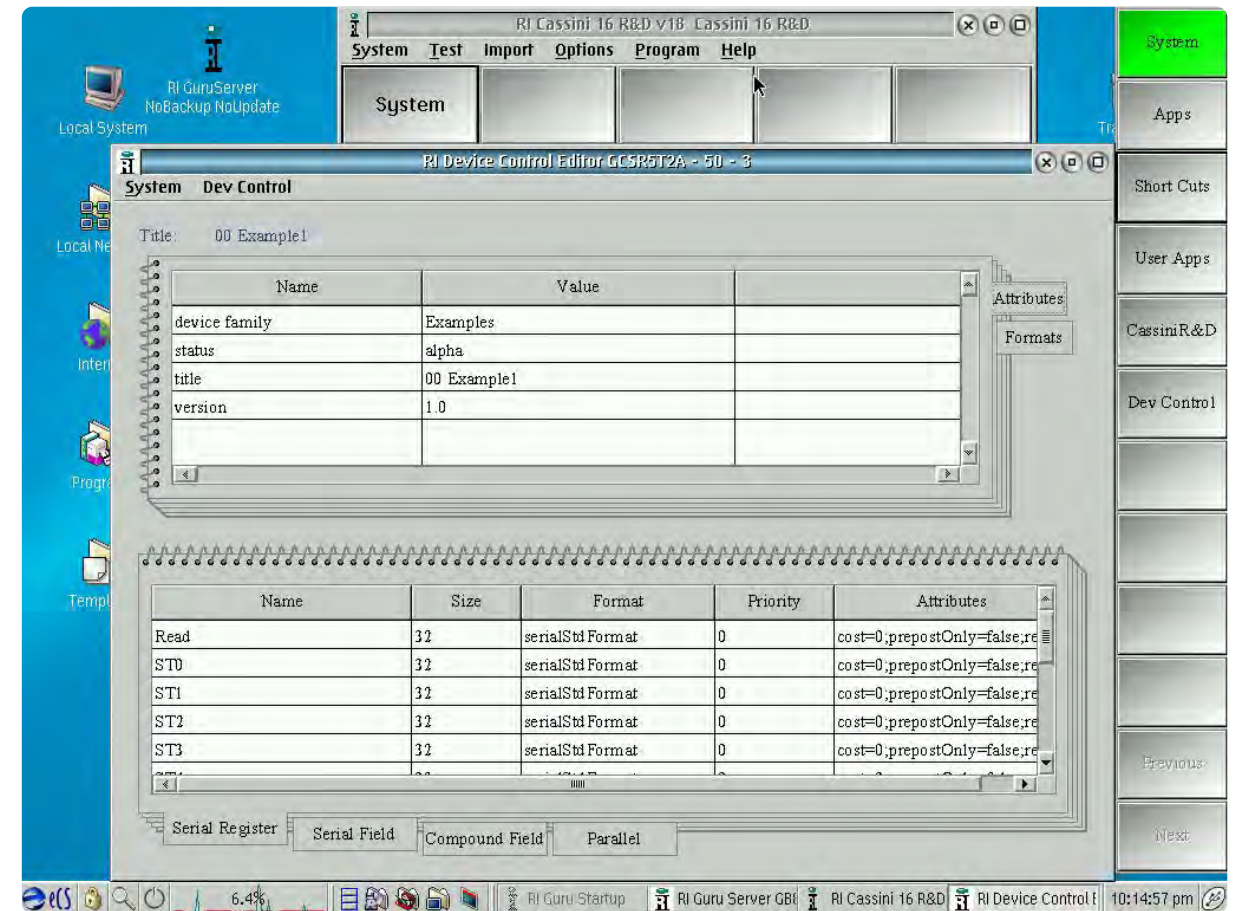
The **Attributes** tab defines the software object properties that are used by Guru for indexed searches and linking the Device Control Definition object to a specific device defined by the user in the [Device Connection Editor](#). Selecting a Device Family value created in the **Device**, **Device Pins**, and **Fixture** tabs of the Device Connection Editor, the Device Control Definition is linked to these software objects, making the control definition available to the specified device and fixture when used in the graphical programming environment.

The **Formats** tab defines the communication protocol and format of the clock and strobe pin. The *type* field designates SPI, I2C, or Parallel protocols, setting the clock/data/strobe behavior. The remaining fields set individual pin and bit stream behavior:

The *clockPolarity* and *strobePolarity* fields set the logic states of the clock and strobe pins relative to the data.

The *direction* field designates big endian ('msbFirst') or little endian ('lsbFirst').

FIGURE 1.91 DEVICE CONTROL EDITOR USER INTERFACE



The panel at the top provides information about the device with tabs located on the right hand side. The 'Attributes' tab displays information about the control definition object: device family, status, title, and version of the device control.

The *strobeLength* field sets the duration of the strobe or latch condition during a data emit.

See [Diagram 2](#) for details on protocol format settings.



**To create a new Device Control Definition:**

1. From the menu options select **Dev Control > New...**
2. In the Create New Device Control Window, fill in the attribute fields that are listed below with their descriptions:

*Title* is the user-specified name of the target device. It is used for device selection.

*Format* provides a drop-down selection list that defines the communication protocol: serialStdFormat (SPI), serialGenericFormat (generic serial), serialI2CFormat (I<sup>2</sup>C), serialI2CEmbedAdd (Embedded I<sup>2</sup>C).

*Device Family* provides a drop-down selection list of available attribute values created in the Device Connection Editor *Device* layer. These link the Device Control Definition to the target device.

*Permission* is automatically selected by the *Permission* attribute created in the Device Connection Editor for the selected *Device Family*.

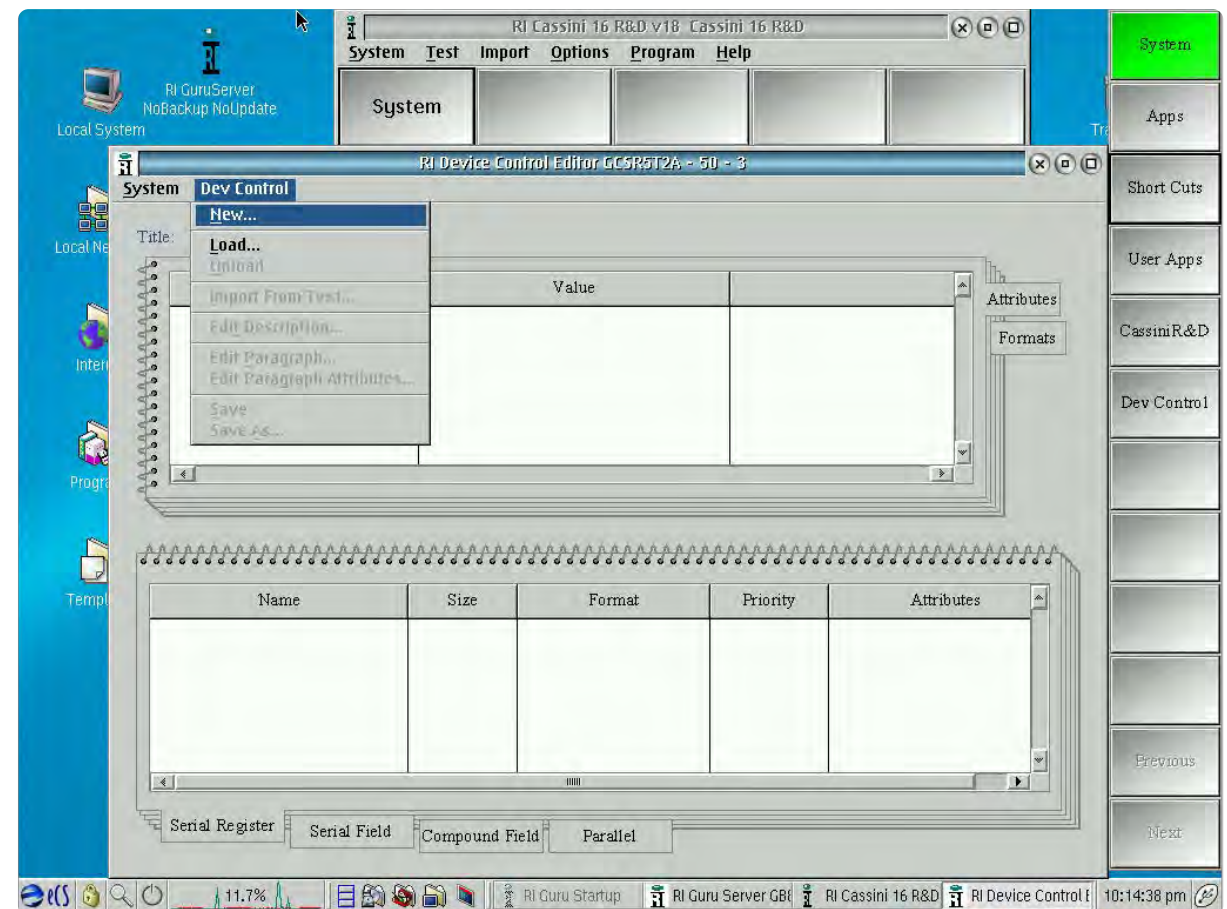
*Version* is a user-defined revision number, i.e - 1.0, 1.1, etc.

*Status* is a drop down selection list of 'alpha', 'beta', or 'released' values. The 'alpha' and 'beta' values are intended for devices that are in stages of development. The 'released' attribute value designates that it is ready for production and makes the Device Control Definition read-only.

*NOTE: The 'released' value prevents changes by disabling the Save menu option.*

3. Click **OK** to add the values to the attribute fields.

**FIGURE 1.92 CREATING A DEVICE CONTROL DEFINITION**



Under the Dev Control menu, select 'New...' to create and define a Device Control Definition. 'Load...' allows the user to view and edit an existing Device Control Definition.

**To save changes to a Device Control Definition:**

1. From the menu options select **Dev Control > Save**
2. In the Save window, Version and Status attribute values can be modified to reflect changes.
3. Click **OK** to complete the save.

*NOTE: Each save creates a history of saved changes of the Device Control Definition. The saved versions can be viewed from the History button in the Load Device Control window.*

**To save a new Device Control Definition:**

1. From the menu options select **Dev Control > Save As...**
2. In the Save As window:  
The *Title*, *Version*, and *Status* can be modified by the user.  
A new *Device Pins Family* and *Device Pins* can be selected from the drop down list of previously created attribute values.  
The *Permission* attribute is inherited from the currently active Device Control Definition and cannot be modified.
3. Click **OK** to complete the save.

*NOTE: A 'Save As' creates a new history of changes thread and does not retain the save history of the original Device Control Definition.*

**To load a Device Control Definition:**

1. From the menu options select **Dev Control > Load...**
2. In the Device Control Selection window, the Device Family and Device Pins attribute value drop down list can be used to narrow the search field.
3. Highlight the device control by left clicking on the desired definition in the table form.
4. Click **OK** to load the latest version of the selected control definition.

**To load a previously saved version of a control definition:**

1. Highlight the device control by left clicking on the desired definition in the table form.
2. Click **History...** to open the Object History window.
3. Select the desired version from the list of saved Device Control Definitions.
4. Click **OK** to load the selected control definition.



## DEVICE CONTROL DEFINITION

The lower panel of the window provides an editable table of the register definitions and tabs that provide contextual input fields. These allow the user to define the number and structure of the register/s with the different protocol tabs described below:

The **Serial Register** tab defines a register or multiple registers in a device:

The *Name* column identifies an individual register or bank.

The *Size* column denotes the number of bits in the corresponding register bank.

The *Format* column defines the protocol type.

The *Priority* column defines the order in which the register bank is emitted during a register write command. A lower number signifies a higher priority, i.e. - a register with a *Priority* value of 0 will be emitted before a register with a *Priority* value of 1.

The *Attributes* column allows for additional compiler directive parameters of the register such as: time cost, settling time, pre/post measure behavior, and read only status.

### To add a Serial Register:

1. Right click on the table form.
2. Select **Add** from the pop-up menu.
3. Fill in the *Name*, *Size* (number of bits in register), *Format*, and *Priority* fields.
4. Select **OK** to add the new register entry.

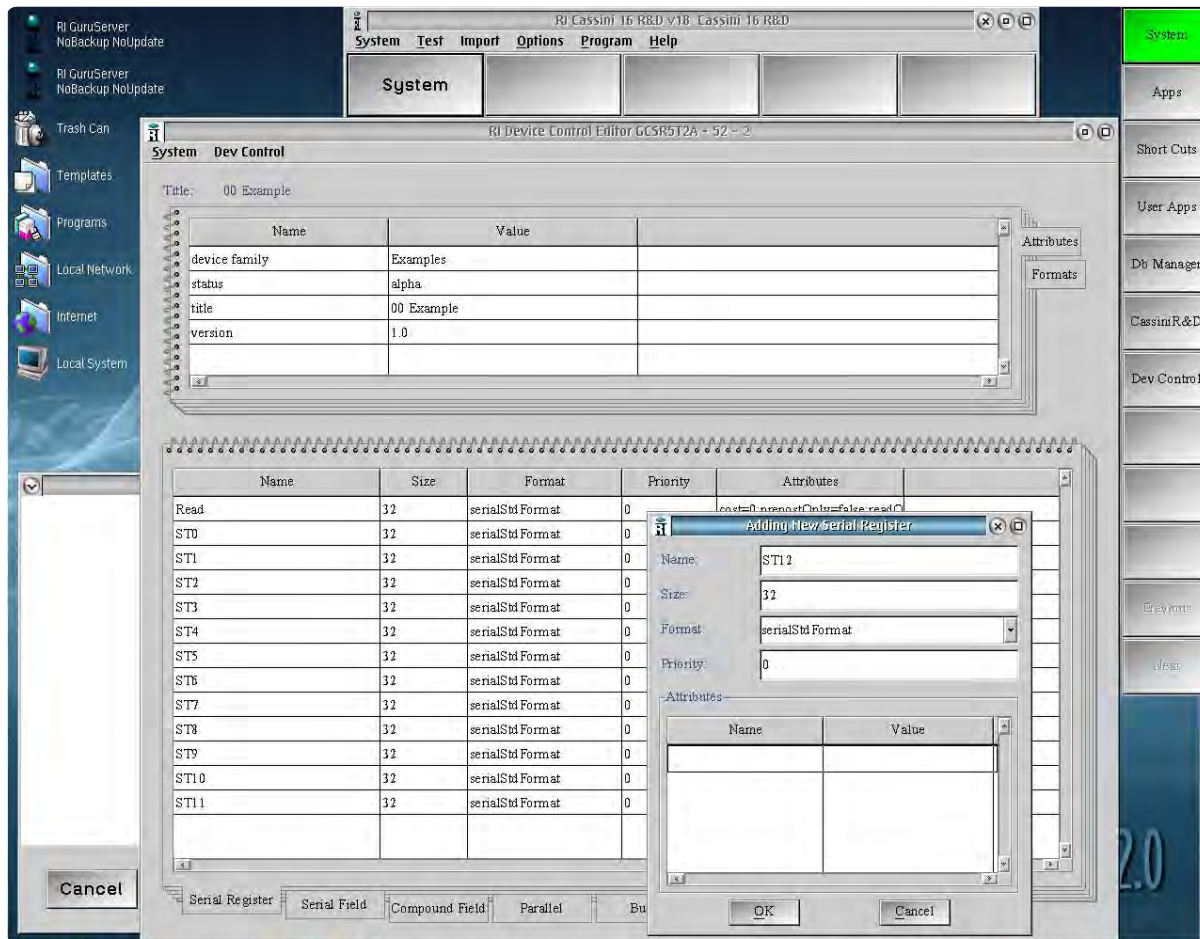
### To modify a Serial Register:

1. Left click on the register of interest in the table row to highlight it.
2. Right click on the highlighted register.
3. Select **Modify** from the menu.

### To delete a Serial Register:

1. Left click on the register of interest in the table row to highlight it.
2. Right click on the highlighted register.
3. Select **Delete** from the menu.

FIGURE 1.93 DEFINING A SERIAL REGISTER



Right click on the spreadsheet to add, edit, copy, delete, and sort registers.

The **Serial Field** tab defines a bit or group of bits within a selected register. These bit definitions are used to create a protocol-aware button in the graphical programming environment that represents the bit settings/state with a user-defined name and parameters as shown in [Figure 1.94](#) and described below:

The *Name* defines the function or segment of bits in the register.

The *Size* defines the number of bits associated with the bit segment starting with the bit location defined by the *First Bit Loc.* field.

The *Register* provides a drop-down list of available registers created in the Serial Register tab to define the register field structure.

The *First Bit Loc.* field denotes the location of the first bit in a bit segment referenced by the *direction* field in the **Formats** tab setting (MSB first or LSB first).

**NOTE:** 'msbFirst' denotes the most significant bit as bit location 1 in the Serial Field first bit location. 'lsbFirst' denotes the least significant bit as location 1 in the Serial Field first bit location.

The *Type* field defines the graphical button representation of the bits in the test plan editor and the type of button interaction (see [Figure 1.94](#) for an example):

'State' creates a drop-down list button with user-defined names and associated bit values to select. When this option is selected, the *State* field below the *Type* drop-down selection is used to define the name

of the state (shown in the button used in the graphical programming environment) and the corresponding bits for the state.

‘Integer’ creates a button with an integer type input corresponding to the associated bits. Reference [button types](#) for more information.

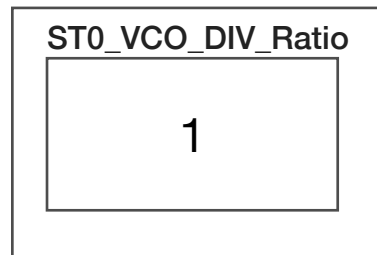
‘Constant’ sets the bit or bits to a fixed value.

*NOTE: A ‘Constant’ type does not create a button in the graphical programming environment since it is a fixed value. If a visible constant button is desired, a ‘State’ type with a single value can be used to represent the button.*

The *Default* field sets the initial state or bit value of the button. This is the “idle” state value of the button in the [Edit Panel](#).

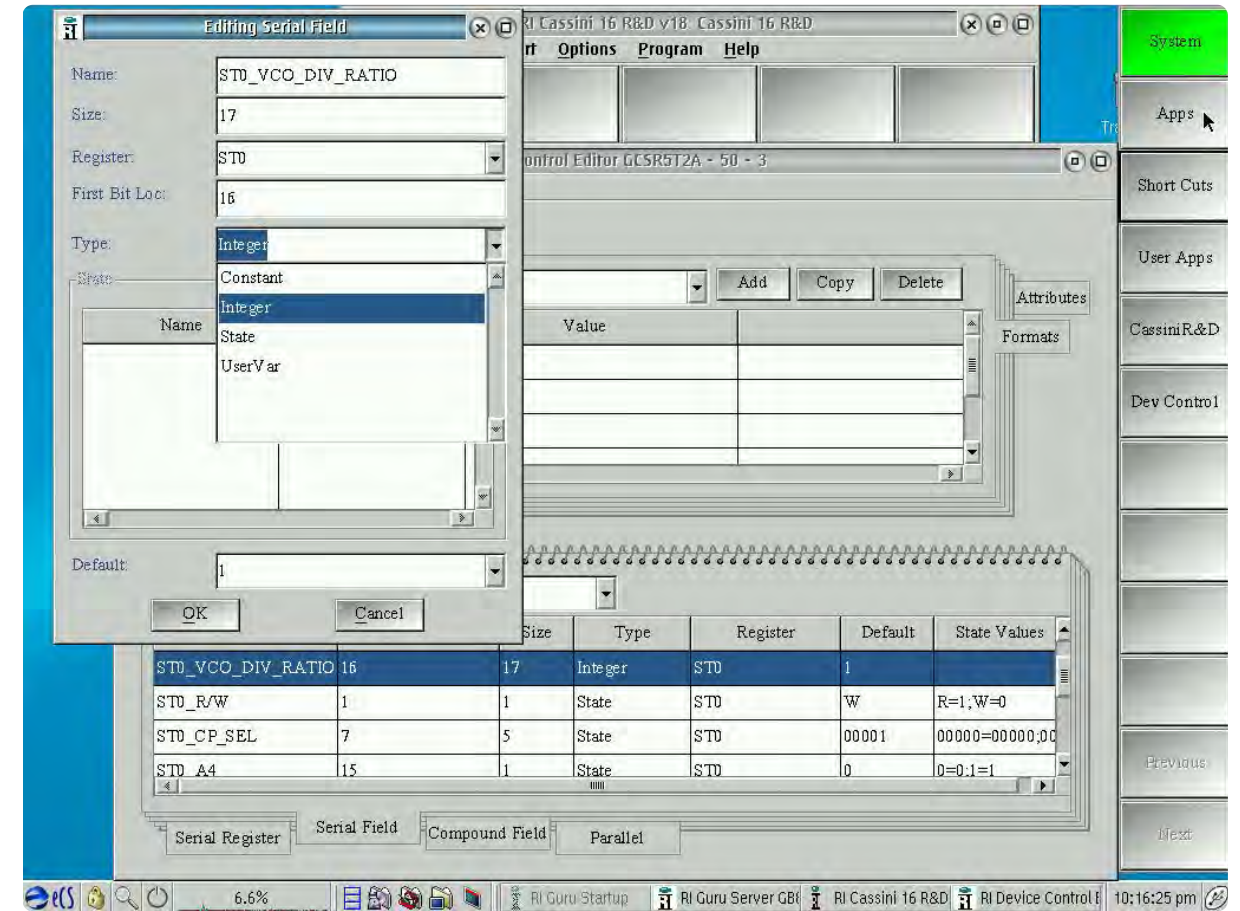
The resulting protocol-aware button has an owner of ‘Dut’ with the *Name* field defining the button function, the *Value* field defining the button parameter, and the *Type* field defining the button type. See the following example based on the values in [Figure 1.94](#):

**Dut**



Register: ST0  
 Name: ST0\_VCO\_DIV\_RATIO  
 Type: Integer  
 Default: 1

**FIGURE 1.94 DEFINING A SERIAL FIELD**



Right click on the Serial Field table to add, edit, copy, delete, and sort Serial Field parameters.

**To add a Serial Field:**

1. Select the desired register to add a serial field from the *Register* drop-down box.
2. Right click on the table form.
3. Select **Add** from the pop-up menu.
4. Fill in the *Name*, *Size* (number of bits in field), *Register*, *First Bit Loc.* (1st bit location relative to the *direction* value in the **Formats**), and *Type* fields
5. Select **OK** to add the new register entry.

**To modify a Serial Field:**

1. Left click on the serial field in the table row to modify.
2. Right click on the highlighted field.
3. Select **Modify** from the menu.

**To delete a Serial Field:**

1. Left click on the field of interest in the table row to highlight it.
2. Right click on the highlighted register.

3. Select **Delete** from the menu.

The **Compound Field** tab defines a group of **Serial Fields** within a register or multiple registers and their bit settings. This allows for multiple register writes and serial bit fields to be expressed as a single button within the graphical programming environment. The compound register is specified with a user-defined *Name* and bit/serial registers parameters as shown in [Figure 1.95](#) and described below:

The *Name* is a user-specified description or function of the group of serial fields.

The *Dependents* field list the serial fields defined by the Compound Field.

The *Data* field list the serial field values of the specified *Dependents*.

The resulting protocol-aware compound field button has an owner of 'Dut' with the *Name* field defining the button function and representing the serial fields and the *Data* field defining the button value and representing the serial field values. See the following example based on the values in [Figure 1.95](#):

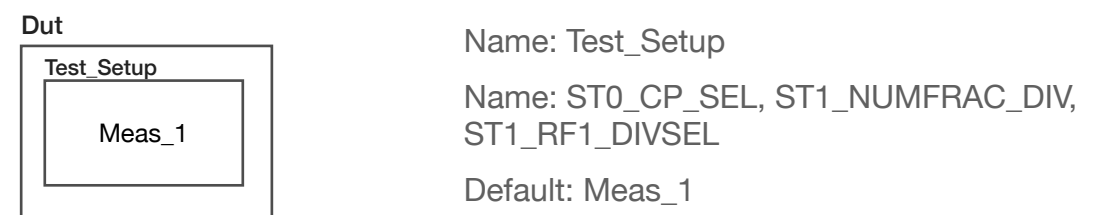
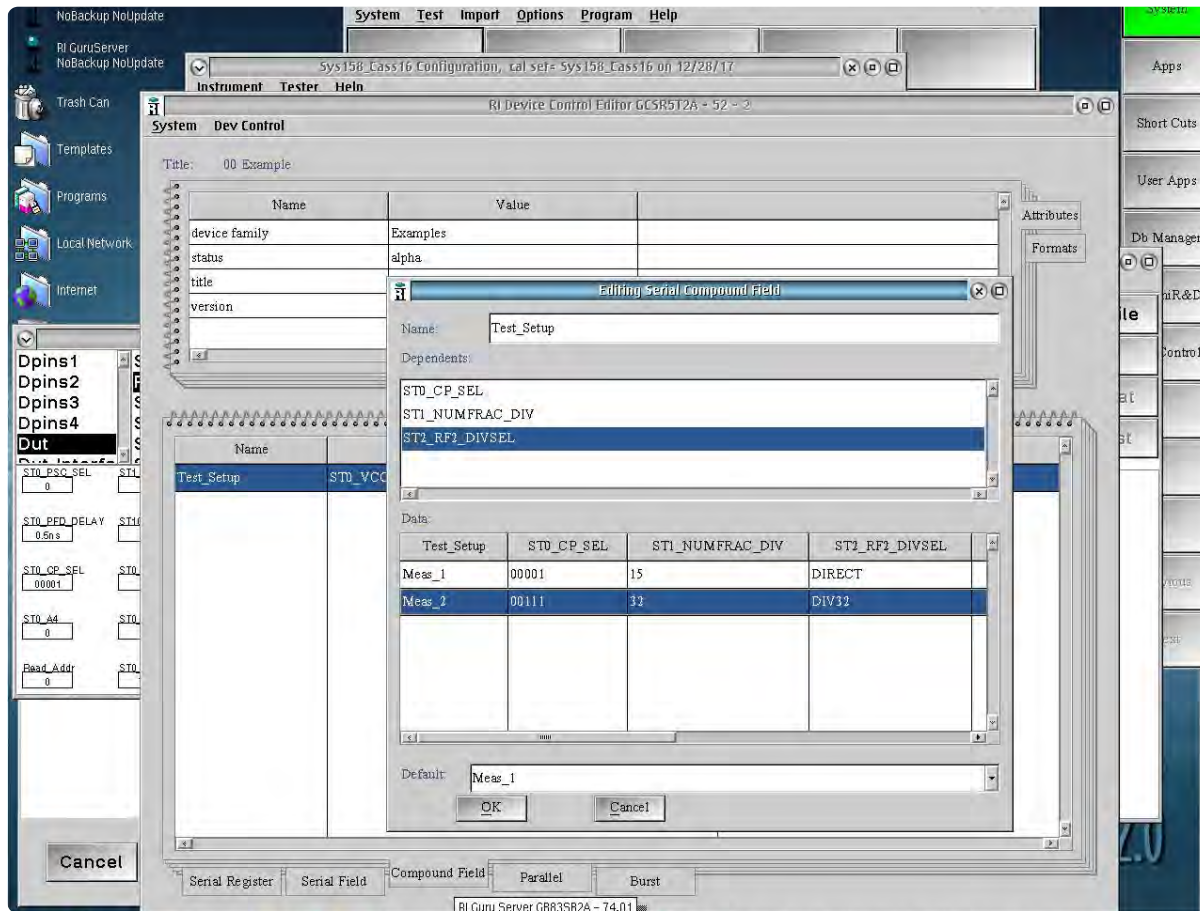




FIGURE 1.95 DEFINING A COMPOUND FIELD



Right click on the spreadsheet to add, edit, copy, delete, and sort Compound Fields.

### To add a Compound Field:

1. Right click on the Compound Field table form.
2. Select **Add** from the pop-up menu.
3. In the Adding New Serial Compound Field window, fill in the values for the *Name*, *Dependents*, *Data*, and *Default* inputs.

### To add *Dependents*:

1. Right click in the field and select **Add** from the pop-up menu.
2. In the New Dependent window select a Serial Field from the drop down list of previously defined values.
3. Click **OK** to add the Serial Field to the Dependents list.
4. Repeat steps to add multiple Serial Fields.

### To add *Data entries*:

1. Right click in the Data field and select **Add** from the pop-up menu.
2. In the Adding Data window, left click on the Value field next to the desired Data field to add a value

**NOTE:** The Data field value must match the entry Type and available values of the Serial Field.



3. Click **OK** in the Adding Data window to update the Data values in the Adding New Serial Compound Field window.
4. Repeat steps to add multiple Data field entries.
4. Select **OK** in the Adding New Serial Compound Field to add the new compound field entry.

#### To modify a Compound Field:

1. Left click on the compound field in the table row to modify.
2. Right click on the highlighted field.
3. Select **Modify** from the menu.

#### To delete a Compound Field:

1. Left click on the compound field in the table row to modify.
2. Right click on the highlighted field.
3. Select **Delete** from the menu.

The **Parallel** tab defines one or more device pins as a parallel port group to create a protocol-aware button in the graphical programming environment. The button has a user-defined name or function that represents the bit settings/state of the parallel port with the port bit mapping defined by a Device Pins Definition created in the [Device Connection Editor](#).

*NOTE: The Parallel communication protocol requires a devicePins family attribute be added to the Device Control Definition that targets a Device Pins definition for mapping the parallel bit resources.*

#### To add a device pins family attribute to a parallel protocol:

1. In the **Attributes** tab, right click on the field and select 'Add' from the menu.
2. In the Adding Port Attribute Window, select 'devicePins family' in the *Name* drop down list.
3. Select the desired device pins from the *Value* drop down list and click **OK** to add the device.

*NOTE: The 'device family' attribute of the Device Control Definition must match the 'device family' attribute of the Device Pin Definition/object created in the [Device Connection Editor](#).*

4. Select **Dev Control > Save** from the menu options to update the Device Control Definition with the new attribute.

#### To create a parallel pin definition:

1. Right click on the table form.
2. Select **Add** from the pop-up menu.
3. In the Adding Parallel Port window complete the fields shown in [Figure 1.96](#) and described below:

The *Name* field provides a user-defined designation of the parallel pins.

The *Size* field denotes the number of bits that represent the parallel port.

*NOTE: The Pin Mapping is inactive until the Size field is specified.*

The *Pin Mapping* form displays a table view of the parallel bit mapping. The number of Port Bit/Device Pins fields are defined by the *Size* field and default to the first device pins available in the Device Pins definition.

#### To modify a Port Bit/Device Pins field:

1. Left click on the desired Port Bit/Device Pins field to highlight it, then right click and select **Edit** from the menu.

2. In the Editing Pins Map Data window left click on the Value drop down list to choose a resource from the Device Pin definition.
3. Click **OK** to complete the changes.

The *Type* field defines the graphical button interaction that will represent the bit values on the parallel port for a given operation:

‘State’ creates a drop-down list button with user-defined names and associated bit values to select. When this option is selected, the *State* field below the *Type* drop-down selection is used to define the name of the state (shown in the button used in the graphical programming environment) and the corresponding bits for the state.

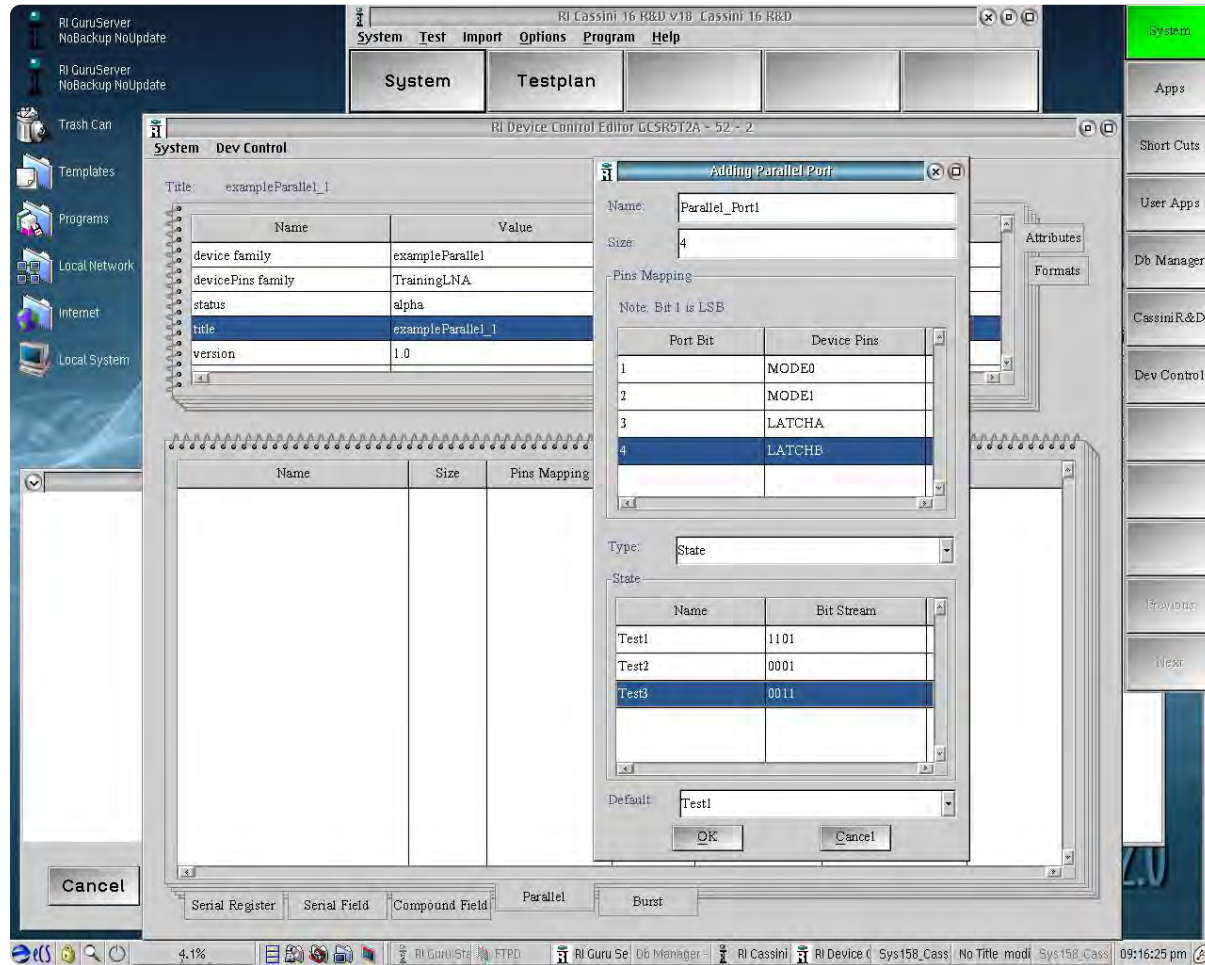
‘Integer’ creates a button with an integer type input button corresponding to the associated bits. Reference [button types](#) for more information.

4. Select **OK** to add the parallel control entry.

#### To Modify a parallel pin definition:

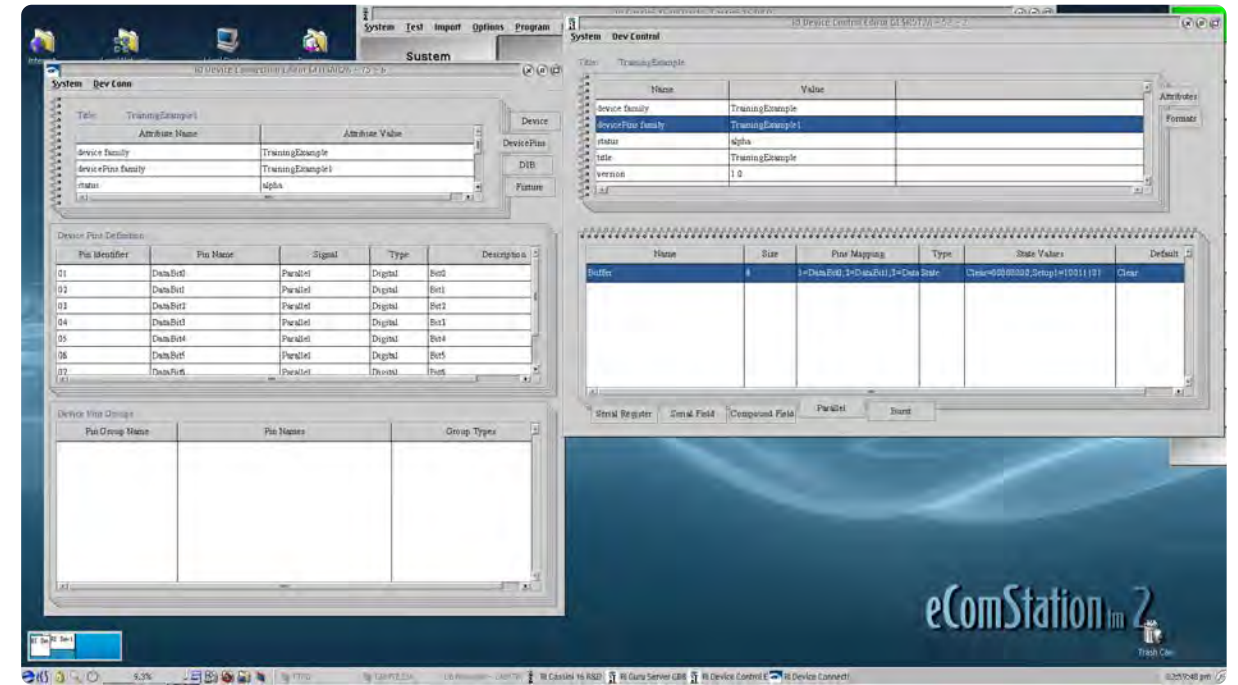
1. Left click on the parallel control of interest in the table form to highlight it.
2. Right click on the highlighted register and select ‘Modify’ from the menu.

FIGURE 1.96 PARALLEL COMMUNICATION DEFINITION



The parallel port name and size are defined by the user, with the port bit mapping options selected from the Device Pins definition.

EXAMPLE A PARALLEL COMMUNICATION DEFINITION



The above example shows the parallel control definition and corresponding Device Pins definition required from the Device Connection Editor.

The **Burst** tab defines a bitstream to be emitted as a single packet or burst in a test plan using the **Serial Data** button found in the *Dpins* instrument of the RI8535: Universal Digital TIM or in the *Static Digital* instrument of the RI8546: Device Power/Measure TIM. Burst types are typically used to define a device mode a DUT with multiple register writes for a test condition setup. It is also used with pointer/address, or conditional register structures where successive register field writes are dependent or conditional on previous register field writes.

*NOTE: Serial Burst device control commands can be used in conjunction with the protocol-aware Serial Field button device control commands in test plans.*

### To create a Burst definition:

1. Right click on the table form and select 'Add' from the pop-up menu.
2. In the Adding New Burst window complete the fields shown in [Figure 1.97](#) and described below:

The *Name* value provides a user-defined designation of the burst command.

The *Type Name*, *Type Value*, and *Value* values provide different options for defining the burst bitstream:

The 'register' option allows the user to select a Serial Register from the list of previously created registers in the *Type Value* field and to

define the bit stream in the *Value* field.

When used with the *Type Value*: 'Generic R/W' selection, the user can input multiple arbitrary binary bitstream values. This is useful for importing large excel and/or .csv register map commands by right-clicking on the Burst field and selecting 'Import From CSV without header' from the menu.

*NOTE: The 'Export to CSV without header' option can be used to generate the .csv import template.*

The 'command' option is used to define a user comment in the burst that is ignored in the bit stream by setting the *Type Value* to the '/' (forward slash character) and the comment in the *Value* field as shown in [Figure 1.97](#).

The 'field' option allows the user to select a previously defined Serial Field within a Serial Register in the *Type Value* field. The bit stream is defined in the *Value* field using the *Type* style of the selected Serial Field: decimal or state values.

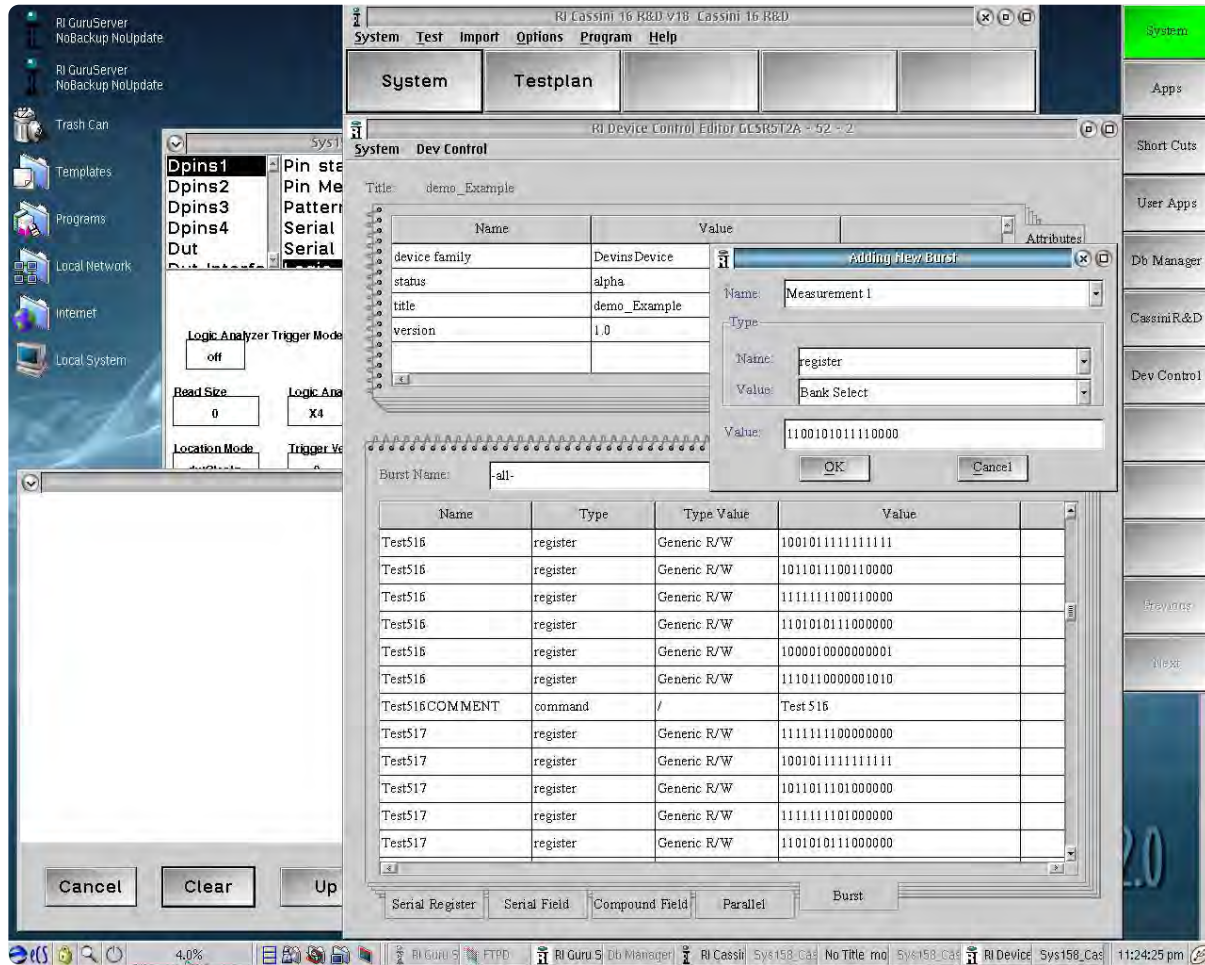
When used with the *Type Value*: 'Generic R/W' selection, the user can input the binary value for the selected Serial Field.

The 'pause' defines a specified delay within the burst by setting the *Value* to desired value in units of microseconds. The *Type Value* field is ignored.

3. Click **OK** to save changes.



FIGURE 1.97 DEFINING A BURST COMMAND



The burst command name and parameters are defined by the user as shown in the above example.

**To modify a Burst definition:**

1. Left click on the desired field to highlight it then right click and select 'Edit' from the pop-up menu.
2. Click **OK** to save changes.

**Using a Burst command in a test plan:**

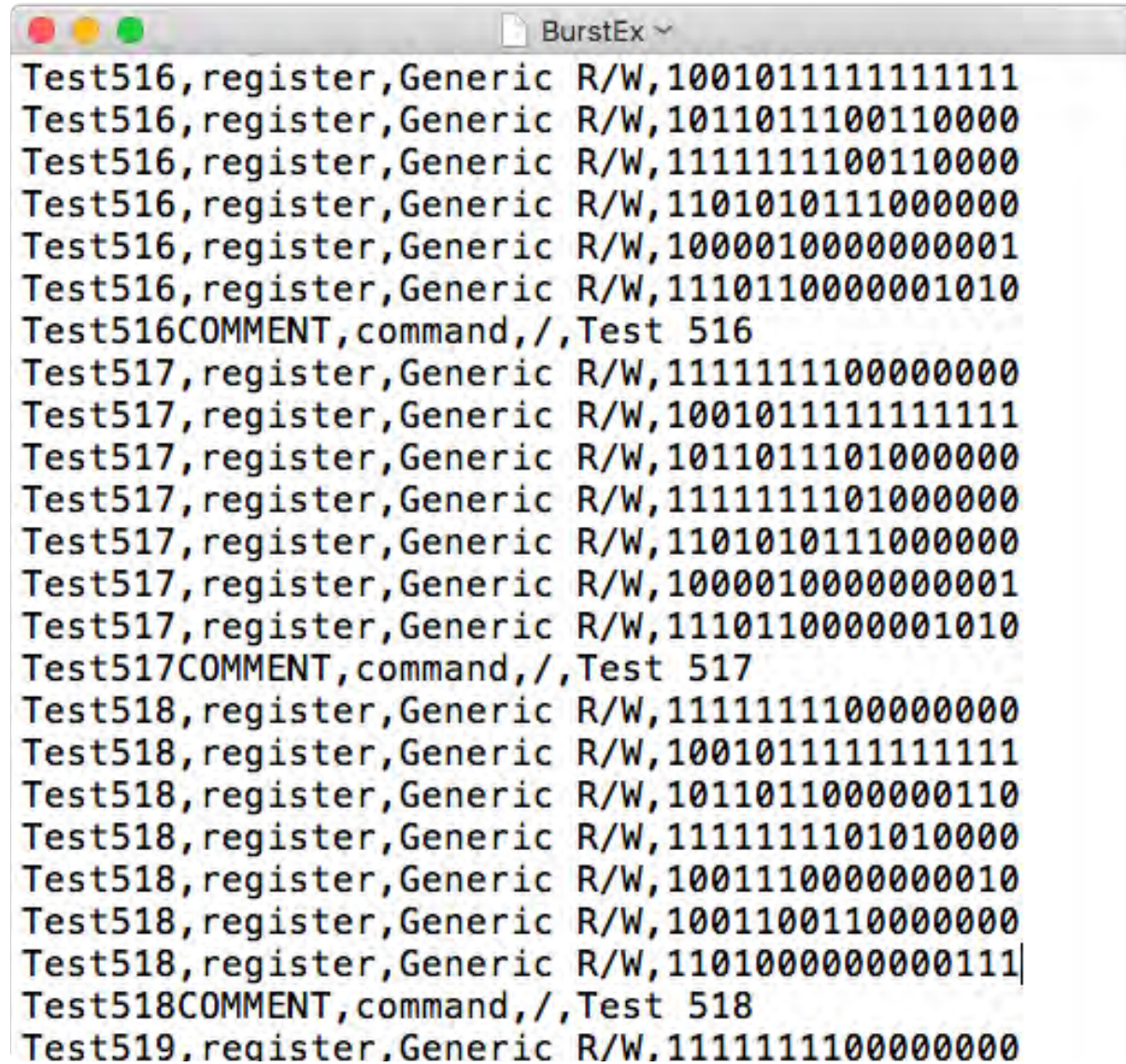
Burst commands are invoked in test plans using the **Serial Data** button (of a Dpins instrument in the RI8535 or the Static Digital instrument in the RI8546) within a premeasure group in a test panel. The command 'burst:[Name value]' is input in the **Serial Data** button to emit all bit/register values with the same *Name* in burst command in the order they are listed in the burst pattern. Using the burst command in [Figure 1.97](#) as an example, the value 'burst:Test516' in the **Serial Data** button as shown below would emit six, 16-bit serial commands sequentially in the order listed in the burst definition.

**Dpins1**

**Serial Data**

burst:Test516

FIGURE 1.98 IMPORT BURST COMMAND FROM .CSV



```
Test516,register,Generic R/W,1001011111111111
Test516,register,Generic R/W,1011011100110000
Test516,register,Generic R/W,1111111100110000
Test516,register,Generic R/W,1101010111000000
Test516,register,Generic R/W,1000010000000001
Test516,register,Generic R/W,1110110000001010
Test516COMMENT,command,/,Test 516
Test517,register,Generic R/W,1111111100000000
Test517,register,Generic R/W,1001011111111111
Test517,register,Generic R/W,1011011101000000
Test517,register,Generic R/W,1111111101000000
Test517,register,Generic R/W,1101010111000000
Test517,register,Generic R/W,1000010000000001
Test517,register,Generic R/W,1110110000001010
Test517COMMENT,command,/,Test 517
Test518,register,Generic R/W,1111111100000000
Test518,register,Generic R/W,1001011111111111
Test518,register,Generic R/W,1011011000000110
Test518,register,Generic R/W,1111111101010000
Test518,register,Generic R/W,1001110000000010
Test518,register,Generic R/W,1001100110000000
Test518,register,Generic R/W,1101000000000111
Test518COMMENT,command,/,Test 518
Test519,register,Generic R/W,1111111100000000
```

The above example shows the .csv format for importing burst commands.



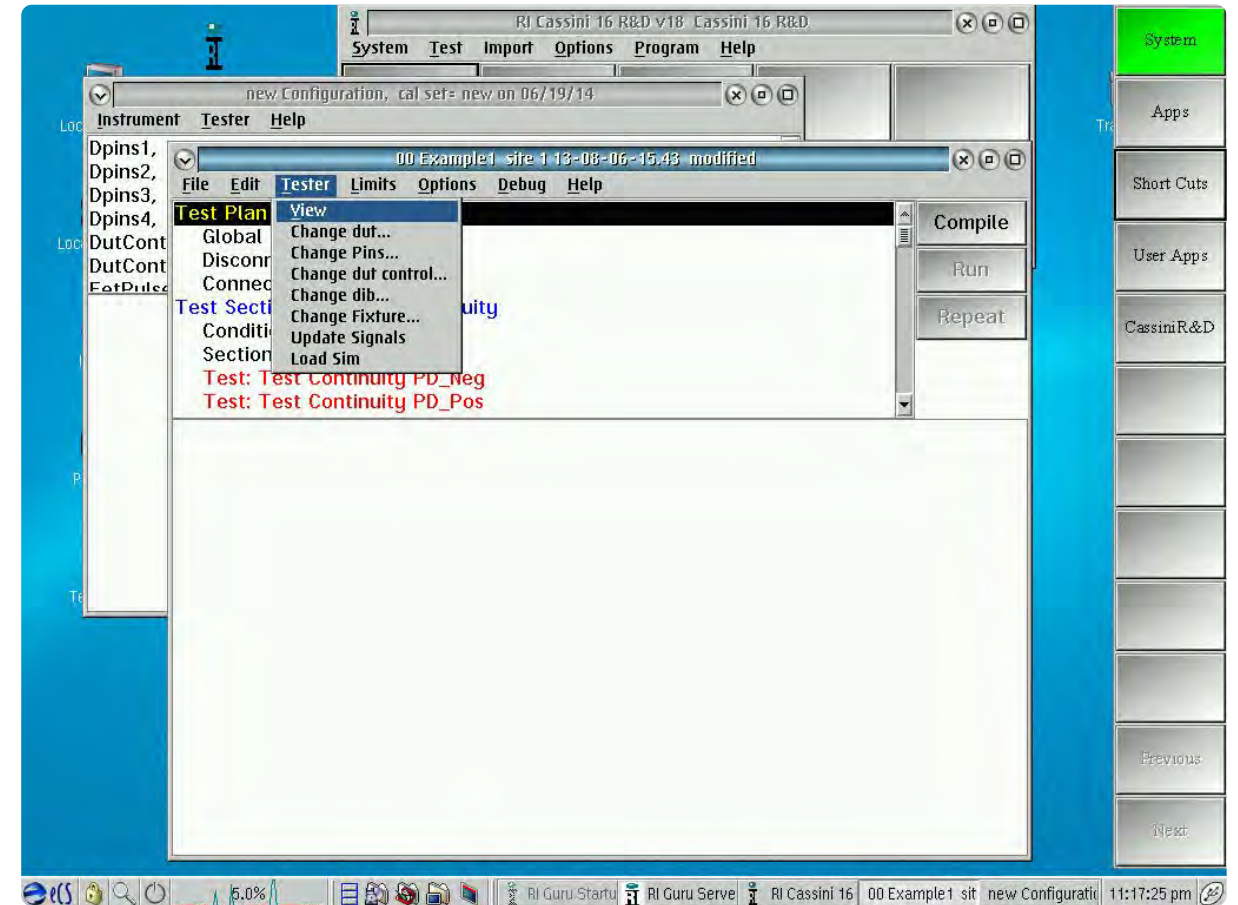
## DUT INSTRUMENT

The DUT (Device Under Test) instrument is a virtual instrument created in the [Device Control Editor](#). This “virtual instrument” provides protocol-aware device control with graphical buttons in the Edit Panel for use in test plans. The underlying bit emits, register structure, and communication protocol are displayed as command/control buttons with user-defined naming conventions for better readability and code maintenance. They are also available in the Control Panel for interactively controlling the DUT register settings at a breakpoint. Reference [Figure 1.90](#), [Figure 1.91](#), and [Figure 1.94](#) on how to create a DUT virtual instrument.

## ADD A DEVICE TO THE SYSTEM CONFIGURATION

To activate a Device Control Definition for use in test plans, a ‘Dut’ instrument must be added as a virtual instrument to the [System Configuration](#).

## GALLERY 1 ADDING A DUT INSTRUMENT



From an open test plan, select the ‘Tester’ menu and ‘Change DUT control...’ from the list to add or change a DUT instrument.

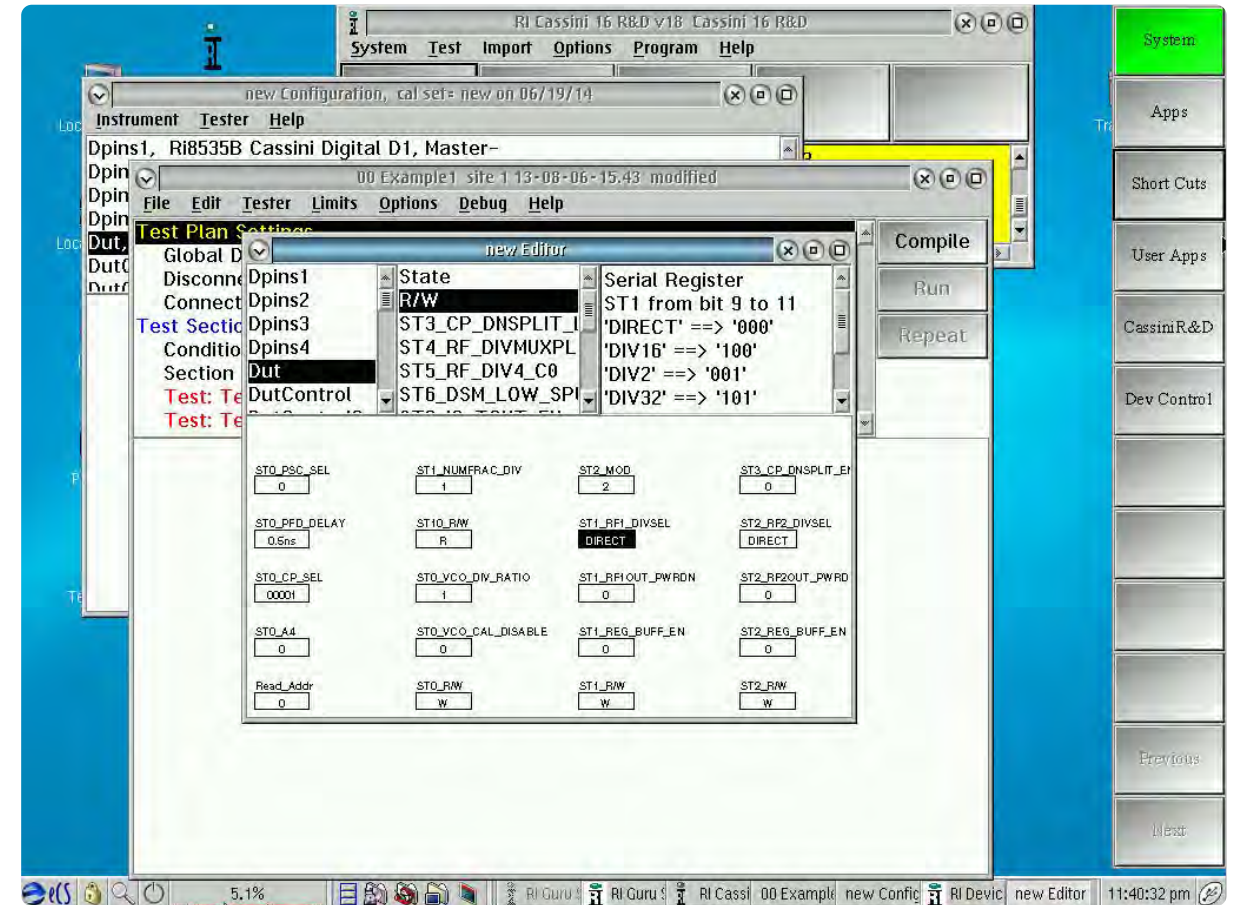


### To add a device (see [Gallery 1](#)):

*NOTE: A target device must be created in the [Device Connection Editor](#) before a DUT instrument can be created and used in a test plan. When creating a new Device Control Definition, the 'Device Family' field drop down list selection in the Device Control Editor must match the 'Device Family' of the user's Device and Device Pins.*

1. From the Main System Window, select 'Test' > 'Devices...' from the menu options.
2. Left mouse click on the desired device in= the Activate Device window and click the **Activate**.

### EXAMPLE B USING DUT CONTROL BUTTONS



After the DUT virtual instrument has been added, a 'DUT' instrument appears in the list of instruments available in the Edit Panel. The middle pane provides windows with 20 buttons in each for all of the protocol-aware controls. Selecting a button from the lower pane provides information about the button's bit parameters in the upper right pane.





# GRAPHICAL PROGRAMMING

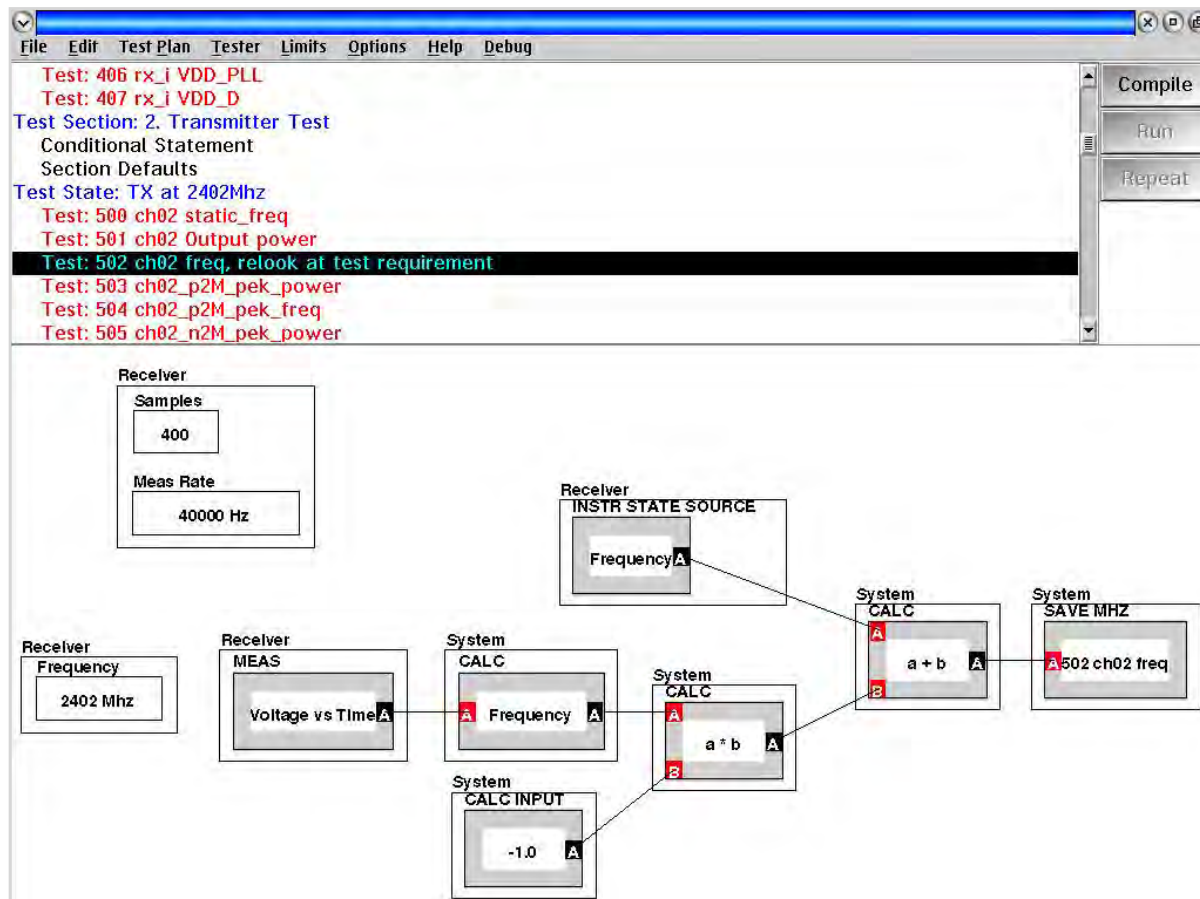
---



The Graphical Programming Chapter provides general information about:

- Test Plan Development Environment
- Test Design
- Button/Measurement Block Functions & Use

# INTRODUCTION



## TOPICS

[Overview](#)

[State Machine Compiler](#)

[Synapse - Automated Test Optimizer](#)

[Graphical Programming User Interface](#)

[Disconnect Settings & Connect Sequence](#)

[Test Program Defaults](#)

[Test Sections & Panels](#)

[Conditional Statements](#)

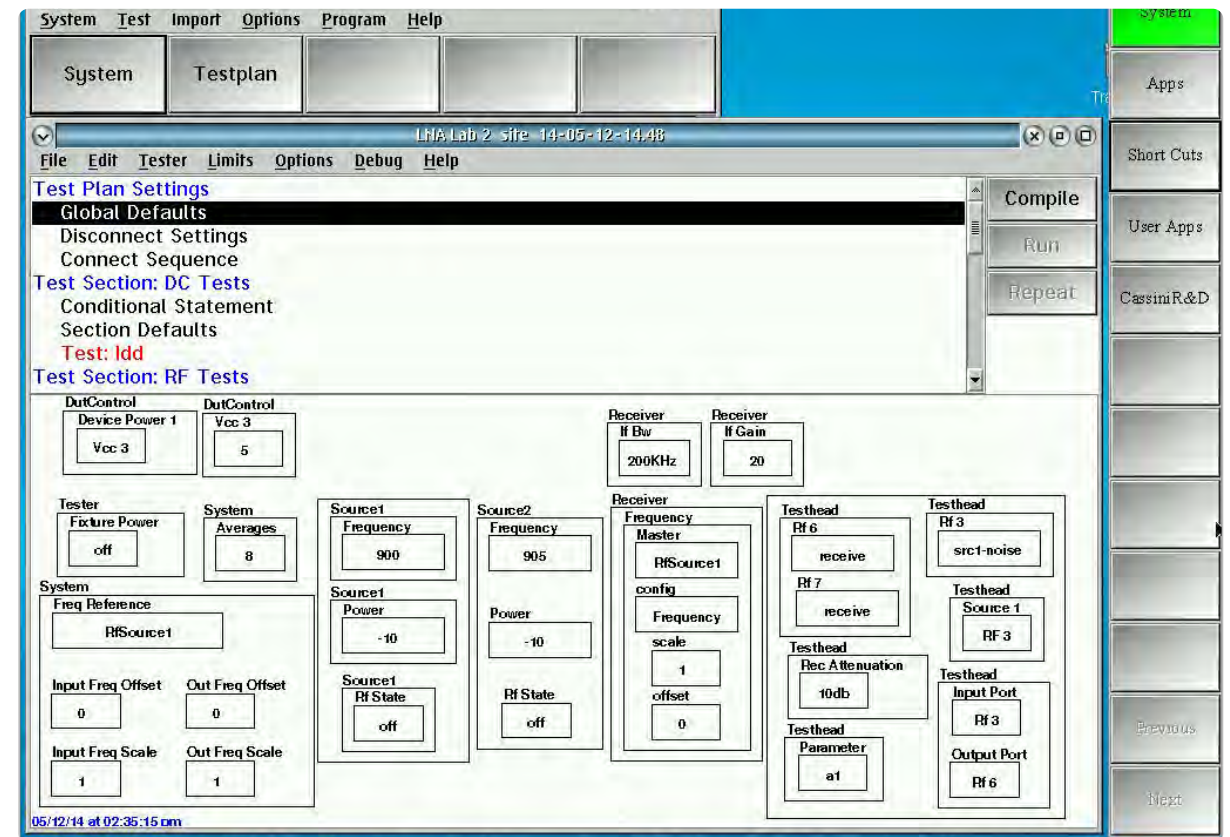
[Instrument Buttons & Measurement Blocks](#)

[Grouping Buttons & Group Types](#)

## OVERVIEW

Cassini was designed from the ground up to have a more comprehensive interaction of hardware and software. Using a state-based approach in the software, the measurement functions and instrument commands operate on the physical resources within the tester at a hardware-state level. What this means for a user on Cassini is that the programming interface and workflow reflect this state-based method when it comes to developing measurement algorithms and building test plans. The object-oriented programming language used to control the instruments is represented in a graphical programming environment, with instrument buttons and blocks that can be connected to control instrument states, and define arithmetic functions or measurements. The library of available instrument buttons and measurement blocks are available in the Edit Panel. These programming resources are dynamically created by the test system from test instrument modules connected to Cassini's test head or added by a user in the simulator. The graphical state-flow abstraction simplifies test plan design with more efficient coding and faster deployment of new instrument and measurement programming elements when compared to traditional ATE programming. The following text provides a brief introduction to the state machine compiler, and graphical programming UI on the Cassini test system followed by instrument button and block descriptions, uses, and examples.

## GALLERY 1 CASSINI GRAPHICAL TEST DEVELOPMENT ENVIRONMENT



### Global Defaults Example

## STATE MACHINE COMPILER

Using the instrument state construct, the compiler translates instrument settings and measurement functions of each test panel in the test program into 'instrument test states'. These states are used to generate a real-time, finite state machine that drives the hardware. Coupled with onboard FPGA based processing in the instrumentation, this enables distributed processing with several key advantages:

1. Real-time signal processing and measurements
2. Absolute instrument/measurement timing and lock-step synchronicity across instruments
3. No processor lags or interrupts from the system computer during test execution since the state machine operates independent of the system controller.
4. Ability to execute real-time instrument state halts of the test system at measurements states with active hardware for in-situ debugging of test programs with interactive instrument and measurement control.

## SYNAPSE - AUTOMATED TEST OPTIMIZER

Synapse is a built-in state optimizer designed to address the two main challenges with test program design:

- 1.) Create test run-time code that eliminates redundant or superfluous instrument calls
- 2.) Create compiled code that executes the fastest and with the highest efficiency for any given hardware setup on the tester.

The optimizer uses the hardware state information of the test objects to analyze the program execution behavior and identify measurements that use shared hardware states to combine or run tasks concurrently in the hardware. As well, the optimizer has access to instrument state transition timing information, i.e - instrument switching and settling times. It uses this information to perform a time cost analysis

optimization to determine the optimum measurement order for the fastest execution. Lastly the optimizer removes redundant or superfluous test states, virtually eliminating unintentional and/or unessential test code.

In addition to the automated test program optimization, the user can view the code execution order, and control how and where optimization can be applied:

- Individual tests and measurement can be isolated from the optimizer
- Groups of sequential measurements can be excluded
- The optimizer can be completely disabled

As well, a comprehensive breakdown of the test program can be viewed through the Delta Settings panel as shown in [Example A](#). This provides test duration information including: instrument setup times, measurement computation, and overall test program time. To access the delta settings, compile an open test plan and select select 'Options' > 'Display Delta Settings' from the menu option at the top of the test plan.

## USER INTERFACE

The test design environment provides both views and user control of test flow organization and test design, see [Gallery 1](#). The user interface window is divided into two sections. In the top pane is a view of the test program flow divided into different programming sections. By default this view contains the "Test Plan Settings" which contains a global default, disconnect settings, and connect sequence



section. The user can add a test section by right clicking within this pane and choosing “Add Test Section” from the selection menu. This test flow view allows the user to control and organize their test plans in a linear flow convention. Selecting or left clicking on any of the test flow sections on in the top pane will display the button or block contents contained within the selected section in the pane on the bottom of the UI. The bottom pane is the test design canvas for placing the graphical instrument control buttons and measurement blocks from the library contained in the Edit Panel.

### To Create a New Test Plan:

1. From the [Main System Window](#), select **Test > Plans** from the menu options.
2. In the *Select Testplan* window, left click on the **new** button to open a blank test plan.

### To Save a Test Plan:

1. From an open test plan window, select **File > Save Guru** from the menu options.
2. The *Save Testplan* window provides a Title field at the bottom for the test plan name and four attribute fields: Type, Device, Version, and Category that allow the user to add user-specified attributes to the saved test plans or select from the available attributes in the drop down list. These attributes are used to link the test plan to specific device and user permissions as well as providing guru search indexes when accessing the test plan.

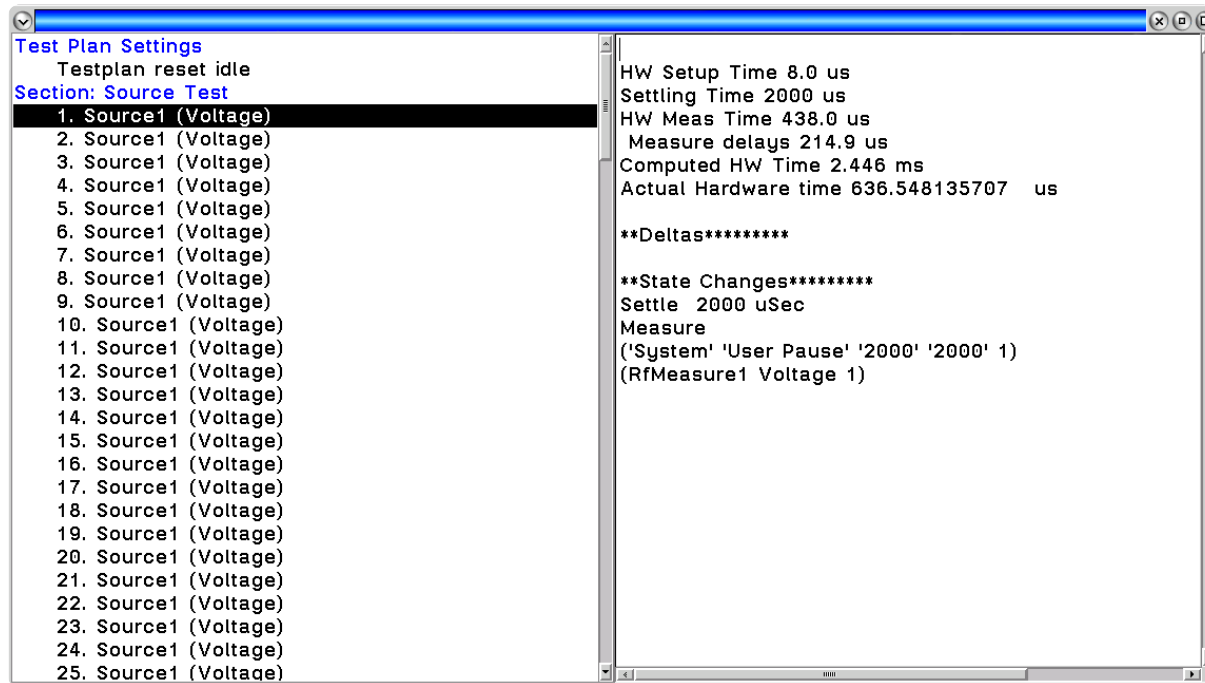
*NOTE: No attribute field can be left blank on an initial save.*

### To Access a Test Plan:

1. From the [Main System Window](#), select **Test > Plans** from the menu options.
2. The *Select Testplan* window provides a scrollable list of all available test plans on the local test system and guru server (if available). The drop-down attribute fields: Type, Device, Version, and Category allow the user to narrow the list of displayed test plans based on the selected values.
3. Left click on the desired testplan to highlight it and click on the **Select** button.

*NOTE: A status window will indicate that the test plan is loading. The window will close automatically once the test program has opened. Loading time can vary depending on the locality of the test plan, i.e. - test plans saved on the local hard drive load faster than test plans fetched from the guru server. Guru server response time is set by the IT/network administrator.*

## EXAMPLE A DELTA SETTINGS



The above figure is the delta settings of a compiled test program. The left pane shows the order test panels are executed in the test program. Selecting a test panel displays the hardware setup time, instrument settling time, estimated and actual execution time of all measurements in the panel. The Deltas section below the timing information displays the order of instrument state changes in the panel.

## DISCONNECT SETTINGS/CONNECT SEQUENCE

The Disconnect Settings and Connect Sequence sections (see images 1 and 2 of [Gallery 1](#)) are used strictly for designating the test system's default states before a test program starts, at the end of a test program, and the sequencing of these states when connecting or

disconnecting from a device under test (DUT). The Disconnect Settings section allows the user to define application-specific resource pin, port settings, and instrument states (that may differ from the test systems default settings or user's global defaults) before the first device under test is placed in the socket and to define the state the tester's instrument pin or port settings return to at the end of a test program before the DUT is removed from the socket. This is the state the system enters first, before the DUT is inserted and before the DUT is removed.

The connect sequence is a specialized section that defines a user-specific order in which resource pins, port settings and/or instrument states are set at the onset of testing. The sequencing executes instrument state buttons in the lower pane following a left-to-right convention for first-to-last order sequencing. The leading edge of placed edit button in this panel defines the left-to-right sequence.

*NOTE: The values or settings of a button placed in the Connect Sequence panel is ignored because by default the test optimizer can select the initial instrument conditions for the first test to improve test time unless otherwise specified by the user.*

## GLOBAL DEFAULTS AND SECTION DEFAULTS

The programming environment has a tiered structure of system, global, section, and panel window defaults to help the user organize and maintain complex test plans and measurements. The System Defaults are essentially the test systems default idle or "safe" state for all the attached instruments. These are subsequently the default

values displayed in the Edit Panel for all of the attached instruments. The Global Defaults section allows the user to define the default instrument state settings that will hold true for the entire test program by placing state buttons in the lower pane. Section Defaults are located in every Test Section, allowing the user to define instrument state settings that will hold true for all test panels with the test section by placing state buttons in the lower pane. Instrument state buttons can also be placed in the test panel to apply the parameter settings for only the measurements contained therein.

The default hierarchy is enforced explicitly in the test program with the highest priority given to buttons placed in the test panel and the lowest given to the system default settings, i.e - a button placed in a test panel will override the button default placed in the test section, global, or system defaults in that order. This default hierarchy is also enforced implicitly in the test program, i.e - when a button state is not defined in a panel, the compiler will default to the value of the button placed in the section default. If the button is not in the section default, the setting will defer to the global default settings. If the button is not placed in the global defaults, the button setting for the test panel will default to the system default settings. This default hierarchy structure gives the user the flexibility to exert control over several measurements or to individual measurements.

*NOTE: State buttons used within the Global Defaults and Section Defaults panels do not follow a sequencing convention. The sequence is controlled by the compiler. Within test panels, the instrument state buttons are executed first, followed by premeasure groups, measurement or function blocks, and finally postmeasure groups.*

## TEST SECTIONS & TEST PANELS

Test sections provide a test flow convention and organization for the user's test program, see image 4 of [Gallery 1](#). The user can add a test panel by right clicking on a highlighted Test Section and choosing **Add Test** or **Add Test State** from the selection menu. Measurements are designed by placing instrument state buttons and measurement or function blocks in the test panel sections. The programmer connects blocks by drawing lines to create algorithmic flow. The lines propagate each block's object attribute information to the connected block to relay data, function, and calling conventions. This allows the compiler to automatically manage data type flow, measurement unit handling, and advanced multi-instrument measurement (virtual instrument) functions for the user. The graphical approach also allows programmers to build test programs and measurement flows by dropping instrument state buttons that represent instrument control states and interconnect measurement or arithmetic element blocks from edit panel library to create algorithmic flow.

## CONDITIONAL STATEMENTS

The Conditional Statements section allows the user to insert control statements that can modify or alter the test program flow during run time, i.e - skip all tests in a test section or abort the test program. The logic statements are defined by the System buttons found in the 'Flow Control' panel of the Editor: **abortIfTrue**, **abortIfFalse**, **skipIfTrue**, **skipIfFalse**, **PromptIfFalse**, and **Prompt**. The first four button types when placed in the Conditional Statements section check the true/false status of conditional flag defined by the user via the **Set Flag**

input block. If the conditional flag status matches the button/s in the conditional section, the test program flow is altered accordingly. See the [Flow Control edit panel button descriptions](#) in Section 11 - RI8574: System Controller (EPC) for more information.

Conditional Statement panels are located at the beginning of every test section, allowing the user to apply the test program flow changes to all test panels/measurements contained therein.

## SYMBOL TABLE

The symbol table allows the user to define integer values and pointer names for use as button values in the graphical programming environment. The symbol file can be defined as a table associated with the test program or as an external text file, separate from the test program, that is requested at runtime. The symbol table can be viewed, modified, and/or saved in an open test plan by selecting the **Options** menu and the corresponding menu choice listed below:

**Options > Load Symbol Table** - prompts the user to choose a symbol table to be associated with the current test plan from all of the available symbol files in Guru.

**Options > Edit Symbol Table** - opens the Edit Symbol Table Window to view and edit the symbol names and their corresponding values.

**Options > Save Symbol Table** - saves the symbol table values and prompts the user for a symbol file name.

**Options > Remove Symbol Table** - prompts the user with an option to delete the symbol table associated with the current test plan.

**Options > Display Symbols** - displays all symbols in the symbol table and

*NOTE: Symbol values are limited to integer values and integer value input buttons.*

## MEASUREMENT BLOCK AND BUTTON CONVENTIONS

There are two types of coding elements used to build graphical test programs: state buttons and function blocks. Both contain object oriented attributes and conventions that relay data, function, and calling conventions to the compiler. When function or measurement blocks' input/outputs are linked, the software can identify intrinsic characteristics of upstream and downstream interconnected blocks in the algorithm flow. This allows the test builder system to check continuity of variable type, data conversion, and unit of measurement as well as automate advanced multi-instrument measurement functions. At the top left of every block or button is the 'Owner' attribute. The owner ties the block or button object to its' associated instrument.

*NOTE: All buttons and blocks must contain an owner. Test Plans that contain buttons and blocks without owners or misidentified owners will fail to compile.*



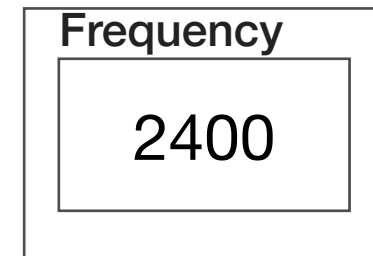
Within the block at the top left corner is the 'Function' attribute that defines the control or operation task. Depending on the type of button or block, the function may denote a measurement, instrument resource or operation. Within the function area are user-editable fields such as variable name, a list of options, or numerical entry.

*NOTE: Buttons or Measurement blocks highlighted in red within a test panel denote the associated instrument is not present or active in the test system. Test Plans with these buttons or blocks will not compile unless the instrument is activated, the test panel or test section is de-activated, or the buttons or blocks are removed.*

## TYPES OF BUTTONS AND MEASUREMENT BLOCKS

Examples and descriptions of the four common button or block types found in the edit panel are given below.

### RFSOURCE1



Owner: RFSOURCE1

Function: Frequency

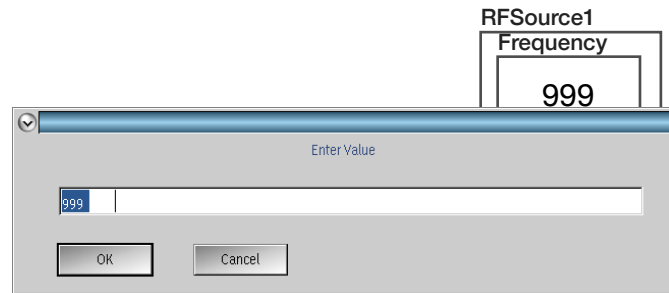
Parameter: 2400 (user defined in units of MHz)

### State Button

Defines an instrument or device setting. These programming elements are used to create a defined instrument or device state within a test panel. They are most commonly used in conjunction with measurement blocks and are executed before any measurement functions are executed within a test panel. Left clicking on the parameter region of a state button will display the input/value options.

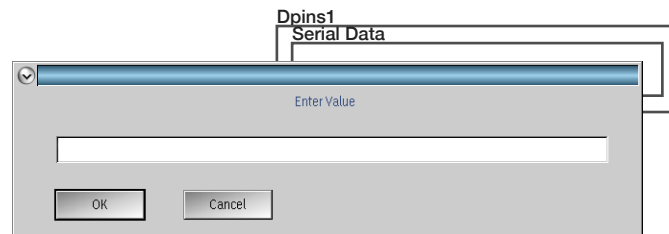
*NOTE: 'Enter Value' dialogs allow SI units in the input field (G=Giga, Meg=Mega, k = kilo, etc.) Most parameters are displayed in standard SI units in the default value (volts, seconds, dBm, etc.). Frequency values without an SI unit in the default are in units of MHz.*

The three types of standard state buttons are shown below:



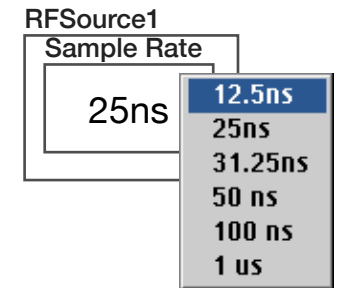
**Integer value**

Integer value buttons prompt the user for a numerical input value. If the numerical value exceeds the instrument’s minimum or maximum range settings, the value is set to the closest acceptable set value at program compile. The input prompt is accessed by left clicking within the parameter field of the state button.



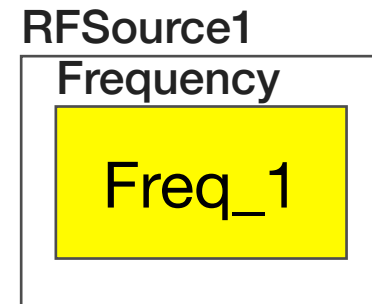
**Text String**

Text string buttons prompt the user for an ASCII input value. The input prompt is accessed by left clicking within the parameter field of the state button.



**Drop-Down List**

The drop-down list button provides a list of selectable settings. The drop-down list is accessed by left clicking within the parameter field of the state button.



Owner: RFSOURCE1

Function: Frequency

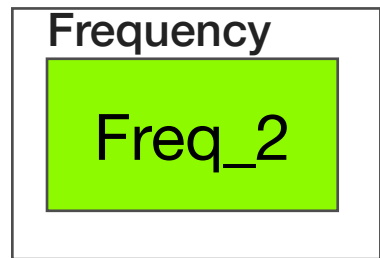
Parameter: Freq\_1 (user-defined local variable in units of MHz)

**State Button set from Local Variable**

Defines an integer value button type that is set by a user-defined local variable that is dynamically generated during test program runtime. The parameter field is color coded yellow to indicate the value is being set by a local variable. The local variable is created using the [Local Var](#), [Local Var Put](#) or [Var Prompt](#) input buttons found in the *System* instrument.

*NOTE: Local Variable button values are not available in the Delta Settings or in a Control Panel at a test program breakpoint because the value is generated at program run time.*

**RFSorce1**



Owner: RFSorce1

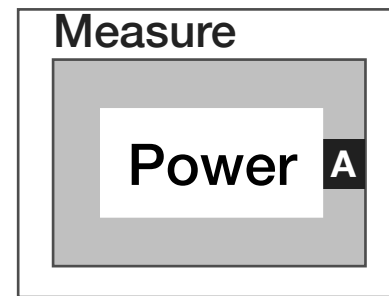
Function: Frequency

Parameter: Freq\_2 (user-defined symbol in units of MHz)

**State Button set from Symbol**

Defines an integer value button type with a user-defined symbol. The parameter field is color coded green to indicate the value is being set by a symbol. Symbols can be created in the test program using the [Set Symbol](#) input button found in the *System* instrument, by defining the values in a symbol table, or from an external text file.

**Receiver**



Owner: Receiver

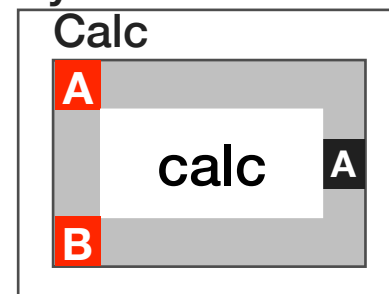
Function: Measure

Parameter: Power

**Output Measurement block**

These blocks are designated with a gray region within the measurement name and provide an output value from an instrument. The black box with “A” denotes the instrument’s measurement output that can be connected to a variable or calculation block.

**System**



Owner: System

Function: Calc (Calculation)

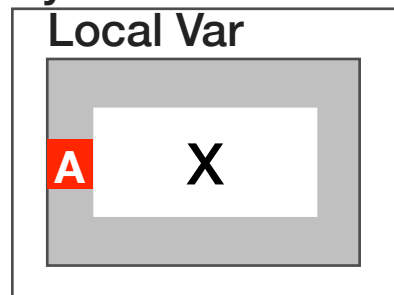
Parameter: calc (a menu list of operations for 2 input, single output calculation are accessed by left clicking the center of the button)

**Calculation or Function Measurement block**

Calculation or function blocks are designated with a gray region within the Function area. These blocks provide one, two, or three inputs on the left side of the block designated by red squares with “A”, “B”, and

“C.” The output on the right side of the block is designated with an “A” in a black square. Algorithmic flow is designed by stringing together multiple blocks with a left-to-right flow convention to denote execution order.

### System



Owner: System

Function: Local Var (Local Variable)

Parameter: X (user-defined variable name)

### Input Measurement block

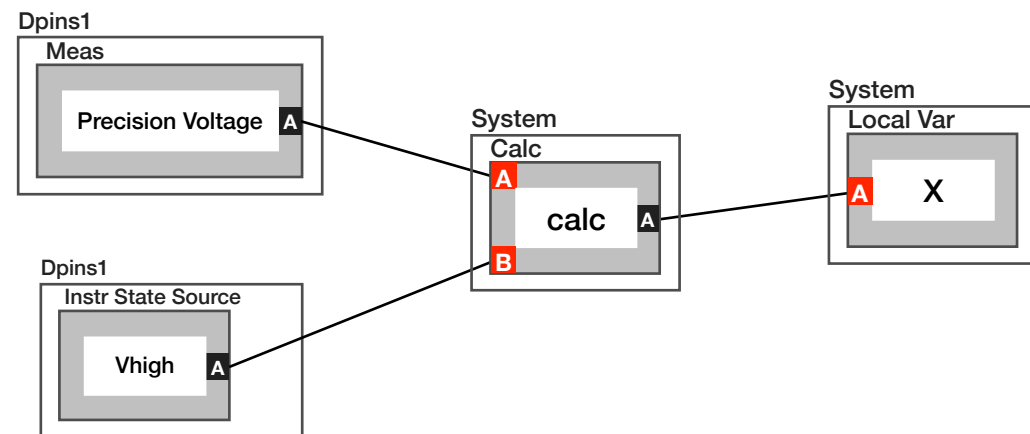
Variables are denoted with a gray region within the Function area and provide an input designated with a red square on the left side of the block. There are two types of variables available: local variables and data saves. Local variables are used for temporary data storage, typically for use between test panels in multistage measurements or multiple step algorithms. Local variable data is discarded at the end of a test plan’s execution.

Data saves store variable information for data logs, final test results, and data reporting and are saved at the end of a Test Plan.

## ADDING BUTTONS & MEASUREMENT BLOCKS

Edit panel buttons can be added to test programs by holding the Ctrl key and left mouse button clicking the button to select it. The button is inserted into a test panel by holding the Ctrl key and left mouse button clicking anywhere on the background of the panel to paste it. This can be repeated to paste multiple instances of the button. When finished, hold the Ctrl key and left mouse button click on the button selected earlier in the edit panel to unselect it. Selecting multiple buttons within an edit panel will allow the user to paste all the selected buttons as a group within a panel. To move the pasted group of buttons individually within a test panel they must first be ungrouped.

## CONNECTING MEASUREMENT BLOCKS



Measurement and algorithmic flow are created by linking function blocks in the test program’s graphical environment. Calculation and logic functions provide connection anchors to accommodate block connections. Inputs are denoted by red squares on the left side of the



function block and outputs are denoted by black squares on the right side of function blocks. Multiple input operands are designated with an “A”, “B”, “C” within the red squares. This convention encourages a left-to-right logic flow design that aids in function comprehension and code maintenance.

### To connect blocks:

1. Right click and hold the center of the block to move and organize blocks of interest relative to one another following the output to input convention of left-to-right
2. To connect an input anchor to and output anchor, right mouse button click and hold within the black/red square of either block of interest.

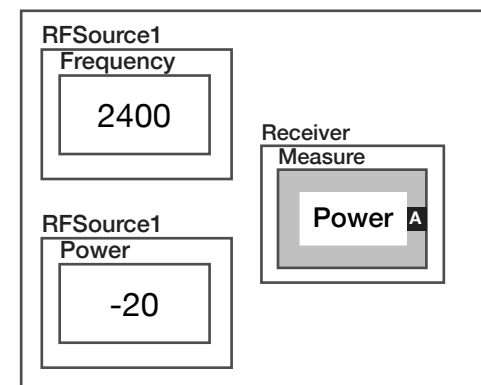
*NOTE: The cursor will change from an arrow to crosshairs to confirm the port selection.*

3. Drag the crosshair cursor and connection line to the input/output anchor (black/red square) of interest on the associated block, either direction works.
4. Release the right mouse button to complete the connection.
5. Multiple output anchor connections can be made to different function block input anchors
6. Input anchors (red) support only one connection per site.

### To disconnect blocks:

1. Right mouse button click and hold within the black or red square of either connected blocks of interest. The cursor will change from an arrow to crosshairs to confirm the port selection.
2. Drag the crosshair cursor and connection line to the origin of the input or output anchor (black or red square) of interest on the associated block to remove the connection.

## GROUPING & UNGROUPING



A button group is denoted by a “grouping box” that surrounds buttons and/or blocks as shown in the example above. Grouped elements can be moved or pasted as a set. Selecting multiple buttons and/or blocks in an edit panel and pasting them in a test panel will automatically group the buttons as a set and provide a shared owner to the grouping box. Button/blocks with different button owners (example above) can be grouped with an arbitrary grouping box to help organize, move and paste them as a set.

**To group a set of buttons together:**

1. Select the buttons of interest by holding the Ctrl key and left clicking anywhere inside the intended blocks/buttons to select them.
2. Right click on one of the selected buttons to view menu options.
3. Select 'Group Selected' to bring up the grouping options.
4. From the grouping options, select 'Group' to place an arbitrary grouping box around the buttons/blocks.
5. The elements can now be selected and/or moved as a single set.

Buttons within a group can be separated by right clicking on the background of the grouping box and selecting 'Ungroup' from the menu. The ungrouped buttons can be individually moved or reorganized.

**Contracting/Expanding Grouped Buttons:**

A grouped set of buttons can be collapsed to form a single button. This can be used to reduce the number of buttons in a panel or complex algorithms that use multiple interconnected calculation and input/output blocks.

**To contract grouped button and/or blocks:**

1. Right click on the background of the grouping box and selecting 'Settings...' from the menu.

2. From the menu list select 'Contract'.
3. A pop-up prompt will allow the user to name the button or input/output block representing the collapsed group. Type a name and select 'OK'.

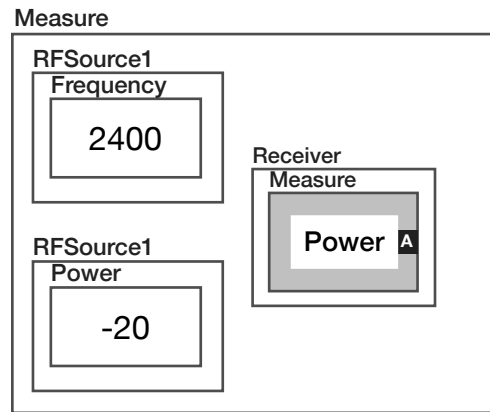
*NOTE: The buttons and/or blocks must be grouped with a grouping box.*

The box must be expanded to view or change buttons within a contracted group.

**To expand a contracted group:**

4. Right click on the contacted button/block and select 'Settings...' from the menu.
5. From the menu list select 'Expand'

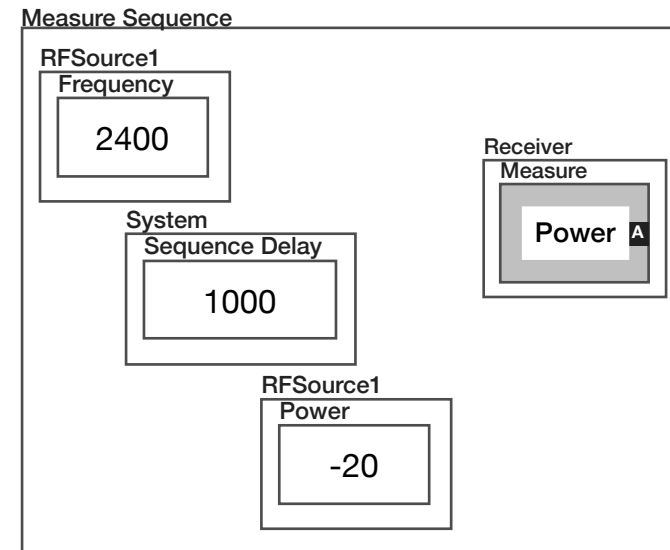
## MEASURE & MEASURE SEQUENCE GROUPS



Measure groups are used in test panels to associate a button setting or multiple button settings with a single measurement. This group type is typically used in test panels with multiple measurements to associate a particular set of button states with a measurement.

### To create a Measure Group:

1. Select the buttons of interest by holding the Ctrl key and left clicking anywhere inside the intended blocks/buttons to select them.
2. Right click on one of the selected buttons to view menu options.
3. Select 'Group Selected' to bring up the grouping options.
4. From the grouping options, select 'Measure' to place the Measure grouping box around the buttons/blocks.



Measure Sequences, much like Measure groups, are used in test panels to associate a button setting or multiple button settings with a measurement. Measure sequences include control of the order in which the button settings are executed and can include multiple measurements in the Measure Sequence grouping. Button settings and measurement blocks are executed from left to right as they are placed in the test panel, using the left edge of the state buttons as the indicator of location. In the provided example, The RFSOURCE1 **Frequency** setting is set to 2.4GHz, then the test system pauses for 1ms (**Sequence Delay**), then RFSOURCE1's signal power is set to -20dB. This group type is typically used in test panels to define multi-step measurements or multiple measurements that require a specific order of operation.

**To create a Measure Sequence Group:**

1. Select the buttons of interest by holding the Ctrl key and left clicking anywhere inside the intended blocks/buttons to select them.
2. Right click on one of the selected buttons to view menu options.
3. Select 'Group Selected' to bring up the grouping options.
4. From the grouping options, select 'Measure Sequence' to place an the Measure Sequence grouping box around the buttons/ blocks.

**PRE MEASURE & POST MEASURE GROUPS**

Pre Measure and Post Measure groups are used in test panels to define a sequence of button settings that occur directly before or after every measurement. Buttons placed within Pre Measure and Post Measure groups are executed from left to right as they are placed in the test panel, using the left edge of the state buttons as the indicator of location. If multiple measurement blocks are placed in the same test panel with Pre/Post Measure groups, the buttons within the Pre Measure are executed prior to each measurement, and the Post Measure is executed after each measurement, i.e - if there are 4 measurement blocks, the Pre/Post Measure buttons will be executed 4 times. Pre Measure and Post Measure groups enforce an explicit execution command to the compiler that overrides the test optimizer, meaning that repeated and/or redundant button state settings will be executed.

*NOTE: Only state buttons (no measurement or calculation blocks) can be placed in Pre Measure and Post Measure groups. If Pre/Post Measure groups are placed in the section defaults, the button settings will be executed before every measurement in every test panel within the test section.*



**To create a Pre Measure or Post Measure Groups:**

1. Select the buttons of interest by holding the Ctrl key and left clicking anywhere inside the intended blocks/buttons to select them.
2. Right click on one of the selected buttons to view menu options.
3. Select 'Group Selected' to bring up the grouping options.
4. From the grouping options, select 'Pre Measure' or 'Post Measure' to place the corresponding grouping box around the buttons/blocks.

**LOCK STEP GROUPS**

Lock Step groups are a button grouping used to link two sweep/range indices or two list indices in a fixed execution order. The lock step group is a compiler directive that overrides the test program optimizer, allowing the user to define the execution order of a specific instrument parameter in a sweep. This is typically used to control the order of operations of two or more instrument button parameter sweeps/lists or to create a user-defined index order for an instrument sweep for plots or datalog saves when used in conjunction with the **Index**, **Inner Loop**, or **Outer Loop** System buttons (reference the [System Edit button descriptions](#) for more information).

*NOTE: Only instrument sweeps, ranges, lists, inner/outer loop, or Index buttons are permitted within the Lock Step group (no measurement or calculation blocks).*

*NOTE: The index size of the range, i.e - the number of indices, of the instrument button pairs used in the loops must match.*

*NOTE: The leftmost button range/sweep parameter within the Lock Step group defines the measurement index in datalog saves and plots.*

**To create Lock Step Groups:**

1. Select the buttons of interest by holding the Ctrl key and left clicking anywhere inside the intended blocks/buttons to select them.
2. Right click on one of the selected buttons to view menu options.
3. Select 'Group Selected' to bring up the grouping options.
4. From the grouping options, select 'Lock Step' to place the Lock Step grouping box around the buttons.

*NOTE: For a Lock Step with a large number of indices, the buttons within a Lock Step group can be converted into a table of values.*

*To create a table of values:*

- *Right click within the Lock Step grouping box, and choose "make CSV" from the pop-up menu.*
- *Right click within the Lock Step grouping box, select "edit CSV" from the pop-up menu to open the table edit window.*

*Only the first button state is required for each button in the group.*

**COMBINED GROUPS**

Combined groups is a button grouping used for digital communication applications such as SPI, Parallel, or I<sup>2</sup>C using the protocol aware [DUT instrument](#). This group type is used to force several device buttons to be executed as a single emit. This is typically used with SPI communication protocols to read or write to multiple registers using a single strobe period versus writing to each register with multiple writes and stobes.

**To create a Combined Group:**

1. Select the buttons of interest by holding the Ctrl key and left clicking anywhere inside the intended blocks/buttons to select them.
2. Right click on one of the selected buttons to view menu options.
3. Select 'Group Selected' to bring up the grouping options.
4. From the grouping options, select 'Combined' to place the Combined grouping box around the buttons.

# RI7725:0.01 TO 20GHz MICROWAVE SOURCE



## TOPICS

---

[Instruments Provided by this TIM](#)

[Test Head Location Information](#)

[Configuration Panel](#)

[Instrument Diagram with Edit Buttons](#)

[Edit Panel Button Descriptions](#)

[Control Panel](#)

Tap the links above to quickly access content.

## INSTRUMENTS PROVIDED BY THIS TIM

The instrument in this TIM appear as **Source1**, **Source2**, **Source3** and **RecLO** in the panel dialog windows. This instrument can also be used as the Local Oscillator (L.O.) for the system's Receiver.

Model and Name as it appears in the Tester Configuration:

- Source1, RI7725x .01 - 20 GHz Rf source

*NOTE: The "1" in Source1 represents the enumeration of the RI7725 in the system configuration. Multiple RI7725 instruments are enumerated incrementally by the system as "1", "2", "3", etc., in the configuration, edit, and control panels (i.e - Source1, Source2, Source3, etc.). This instrument is named RecLo when used as a Local Oscillator for the system's Receiver. The "x" in RI7725x denotes the model revision number.*

## TIM LOCATION

The RI7725 used in located in the Auxiliary Rack and uses an auxiliary rack TIM, also referred to as a Remote TIM, to route resources to the test head. Remote TIMs are typically placed closest to the Auxiliary Rack (slots T1, T2, T15, T16). In a typical application, the source resources are routed, via RF semi-rigid interconnect cables, on the fixture bottom plate or interface plate to Test Set and/or Receiver TIMs.

*NOTE: Always calibrate the named paths after any changes to the layout (bend) in the cables from the Source through the AUX Rack's Remote TIM to maintain maximum signal fidelity.*



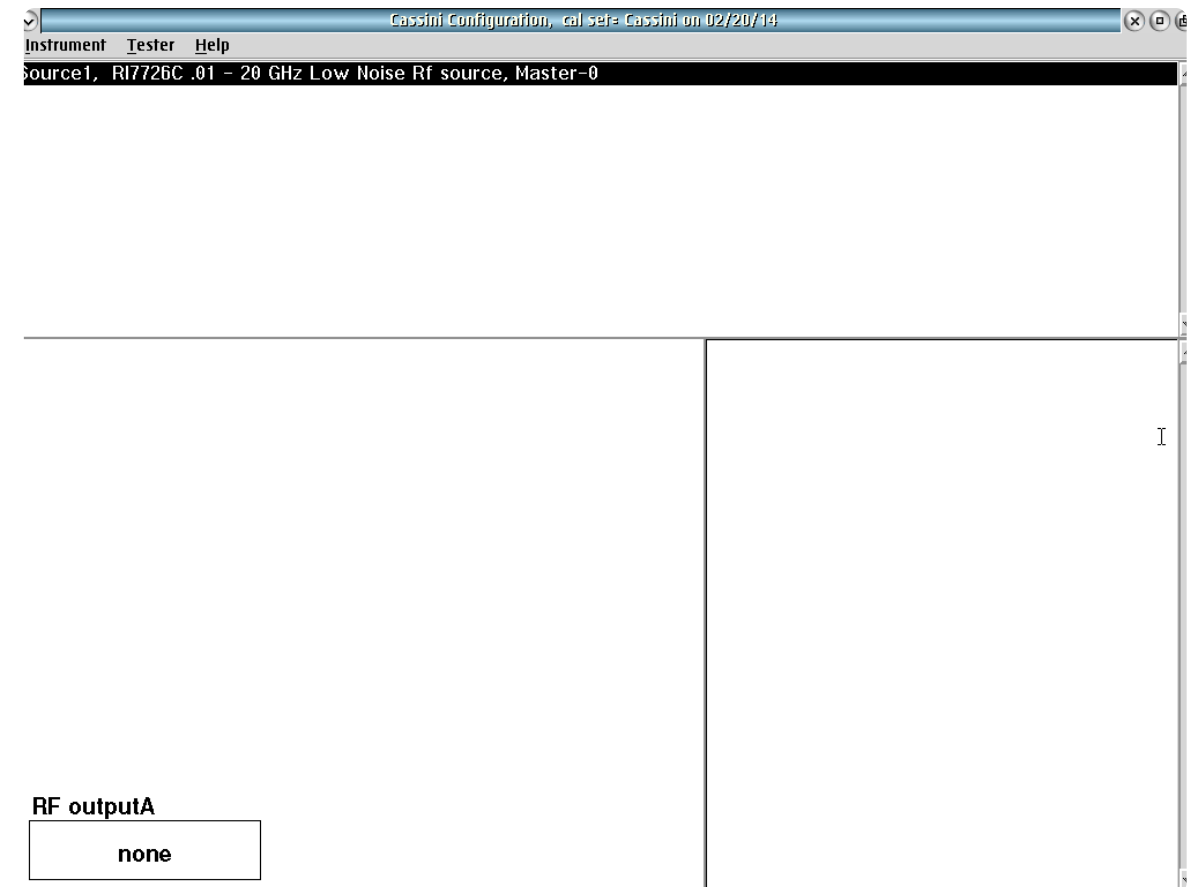
## CONFIGURATION PANELS

View connection settings for the Source1 instrument.

### SOURCE1

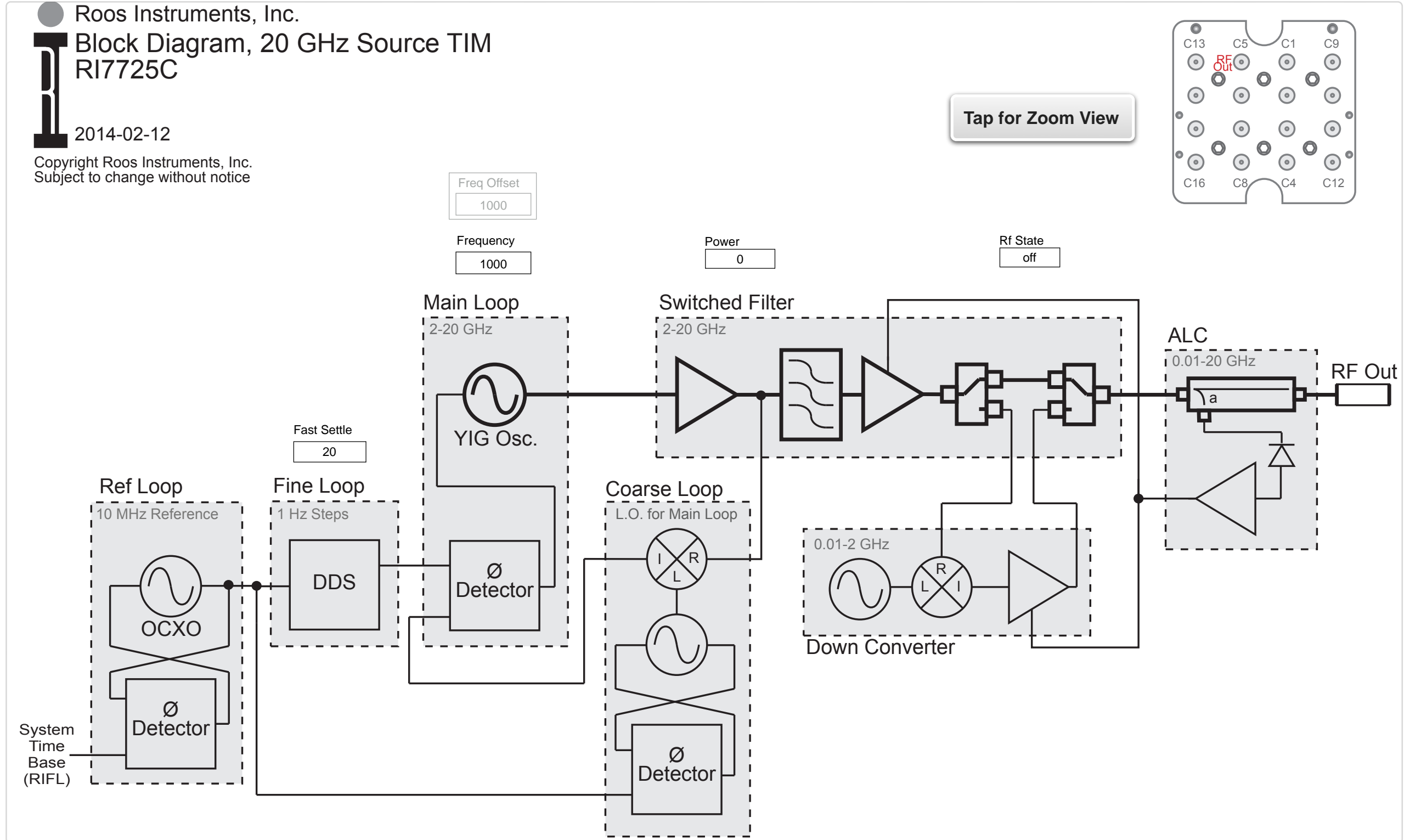
The Source1 instrument provides one setting in the configuration panel: **RF outputA** with only “none” as an option.

## CONFIGURATION PANELS 1 RI7725 CONFIGURATION PANEL



Source# configuration panel shows “none” as only connection option since the Device Connection Editor is now used to define connections.

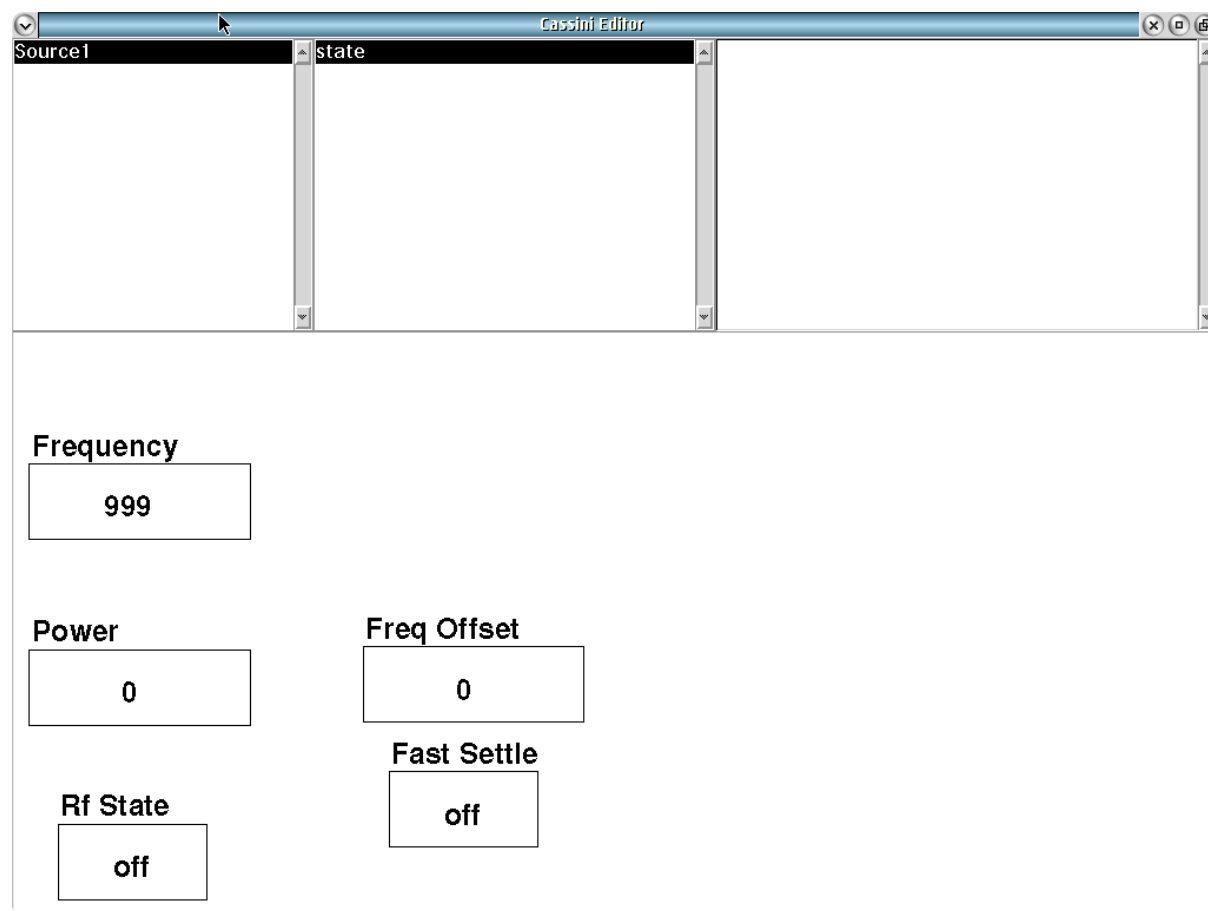
### INSTRUMENT BUTTON DIAGRAM 2.1



## EDIT PANEL

The catalog of control buttons for this TIM to be use when building automated Test Programs. Each “Source#” instrument includes control of it’s frequency and power etc.

### EDIT PANELS 1 RI7725 EDIT PANEL



Source# edit panel only includes “state” buttons.

## STATE PANEL

Frequency

999

### Frequency

A decimal notation input button that sets the Phase Locked Source Output Frequency in units of MHz with 1 Hz resolution.

Power

0

### Power

A decimal notation input button with units of dBm that sets the Source RF Power, taking into account all the current path losses, to deliver the desired power at the device. The hardware minimum resolution is 0.1 dBm and the actual dynamic range is a combination of the maximum available power and the current path losses including any step attenuator value. ALC dynamic range is typically <35 dB.

Rf State

off

### Rf State

A drop down list button that in the “off” state sets the RF Output Power control ALC section to the lowest value (typical Range is >35 dB), but depending on the desired output power commanded, the

Source Step Attenuator setting, and fixture losses, etc., the amount of available range may vary.

*NOTE: Check to see how much power is being delivered to the device in the “off” state and if it could be an issue, to completely remove the sources signal contribution, the test developer should switch the Rf signal to an unused path in the Test Head, or Fixture etc. Select one of the solid state switches if possible since anything mechanical has a finite life time.*

**Freq Offset**

0

### **Freq Offset**

A decimal notation input button that adjusts the generators final stage Phase Lock Loop’s post lock output frequency within its  $\pm 10$  MHz range, used for fast short Frequency moves.

**Fast Settle**

0

### **Fast Settle**

A drop down list button that adjust the settling time of a frequency change to either Phase Stable (the default “off” position) or Amplitude only stable (“on” position). Settings this button to “on” reduces frequency change times by more than 60%.

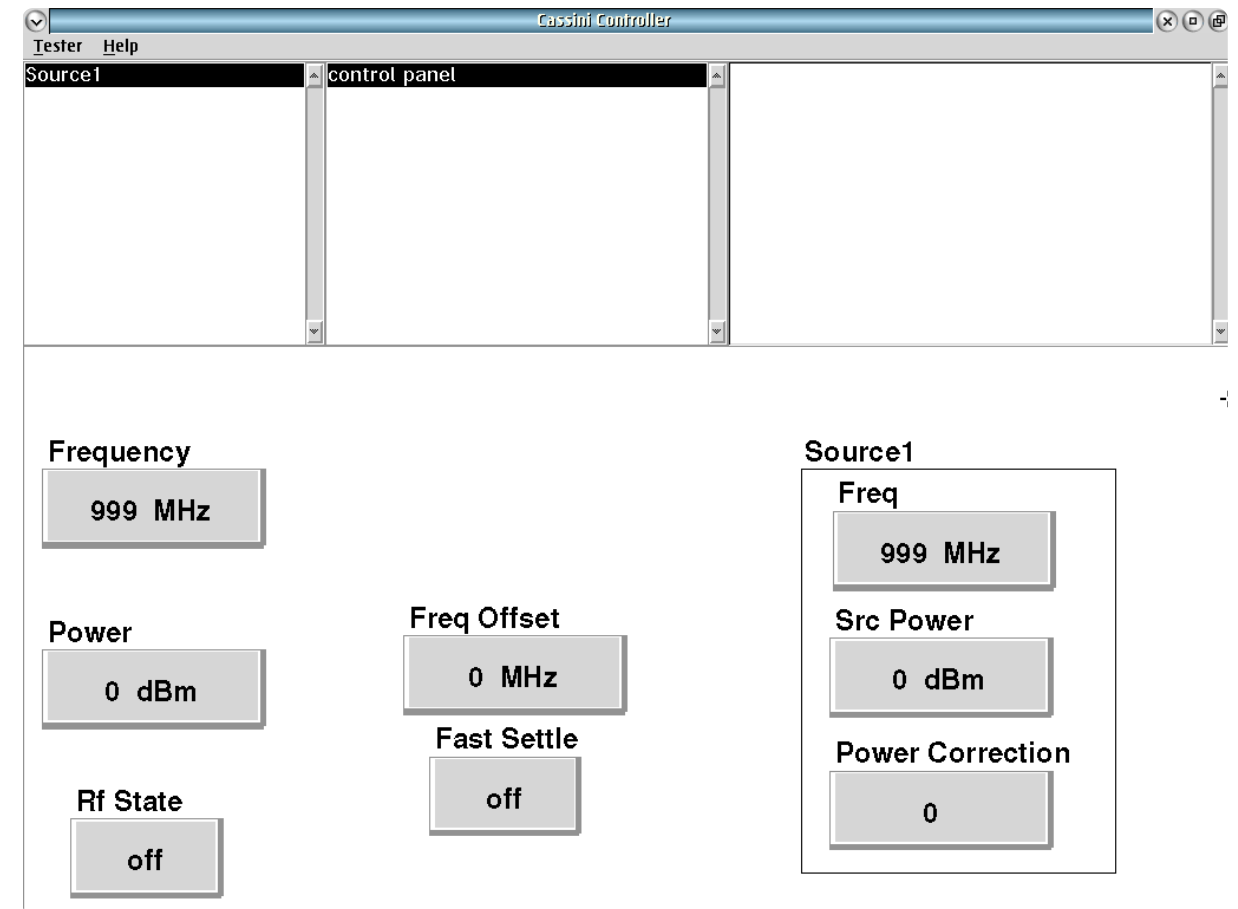


## CONTROL PANELS

The catalog of real-time control buttons for this RF Source TIM that produces a phase locked 10 MHz up to 20 GHz sine wave signal connected through an AUX rack to a special “Rack Connection” TIM that exposes the standard RF Ports and provides control.

Along with the realtime control buttons that look and operate the same functions as in the edit panels, an information only display button grouping provides a window into what the actual source parameters are set to independent of any system wide frequency offsets or path loss power corrections. This is extremely valuable when debugging the entire Tester, Test Fixture and Device Interface Board path.

### CONTROL PANELS 1 RI7725 CONTROL PANEL



Source# control panel to change states and see power correction.

# RI8508: RF MODULATED SOURCE



## TOPICS

---

[Instruments Provided by this TIM](#)

[Configuration Panels](#)

[Instrument Diagram with Edit Buttons](#)

[Edit Panel Button Descriptions](#)

[Control Panel](#)

Tap the links above to quickly access content.

## INSTRUMENTS PROVIDED BY THIS TIM

The subset instruments in this TIM appear as **QamSource1** and **RFSource1** in the panel dialog windows.

Model and Name as it appears in the Tester Configuration:

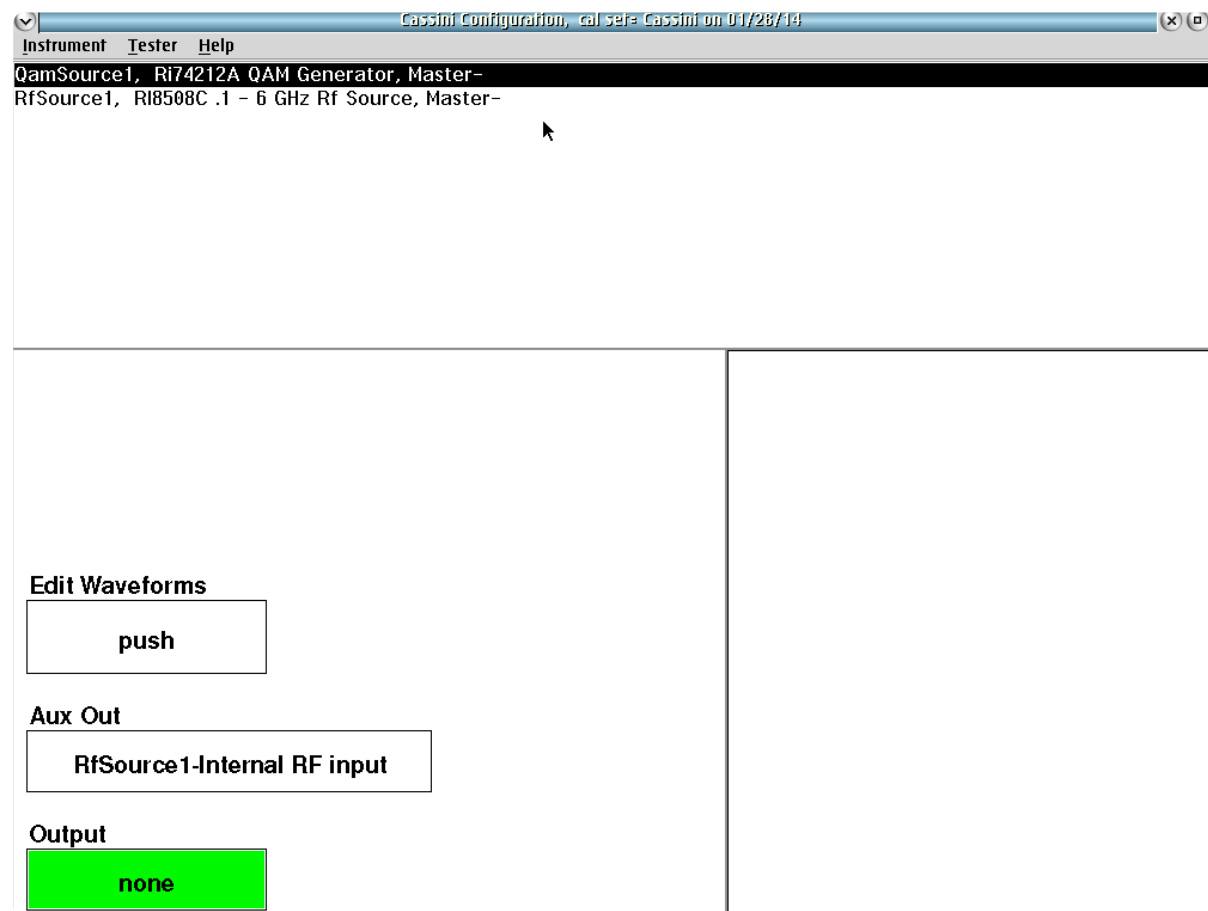
- QAMSource1, Ri74212x QAM Generator
- RFSource1, RI8508x .1 - 6GHz Rf Source

*NOTE: Multiple RI8508 instruments are enumerated incrementally by the system as “2”, “3”, etc. in the configuration, edit, and control panels (i.e - RFSource1, QAMSource1; RFSource2, QAMSource2 ; RFSource3, QAMSource3 ; etc). The “x” in RI8508x denotes the model revision number.*

## CONFIGURATION PANELS

The configuration panel displays the resource port mapping of the QamSource and RfSource instruments and loaded waveforms in the RI8508's on-board FPGAs.

### CONFIGURATION PANELS 2 RI8508 CONFIGURATION PANELS



**QamSource1** configurations including waveform and output configurations.



## QAMSOURCE1

The QamSource instrument provides three settings in the configuration panel: Edit Waveforms, Aux Out and Output. The green Output button defines the instrument resource connection defined by a fixture.

*NOTE: "Output" can only be defined by a fixture definition.*

## EDIT WAVEFORMS

This button displays the current waveform/pattern loaded into the QamSource's arbitrary waveform generator. A left-button click on the button opens the Edit QamSource Patterns window (See [Figure 2.1](#)). The left pane of the Edit Patterns window displays a list of all waveforms that have been loaded into the instruments on-board memory. Selecting any of these waveforms with a left-mouse button displays more information in the right pane: start address in memory, number of samples, sample clock rate, peak magnitude, RMS magnitude in dB, and information about the original waveform file from Guru. New waveforms can be added to the list by selecting **Pattern > add from Guru** from the menu options. The user can then select a waveform from Guru and specify additional information.

*NOTE: Waveforms are programmed into memory sequentially. While waveforms can be removed from the list view by selecting them and using the menu option “Pattern > remove,” they are not erased from the memory. To make used memory available again, all waveforms must be purged using the “Pattern > Erase > All Patterns” menu option.*

## AUX OUT

This drop down list button selects the TIM’s internal resource routing to the auxiliary port. This selection will define the resource available at this port when using a state button within a test program or panel.

### Example

From : QamSource1-Internal RF output- internal:  
base name: AuxOut  
type: internal

To : RfSource1-Internal RF input  
base name: AuxIn

Path : QamSource1-Internal RF Output- internal:  
RfSource1-Internal RF input

## RFSOURCE1

The RfSource instrument provides five user settings in the configuration panel: Edit Patterns, aux In, Aux In, Output2, and Output1. The green Output2 and Output1 buttons define resource connections to the fixture.

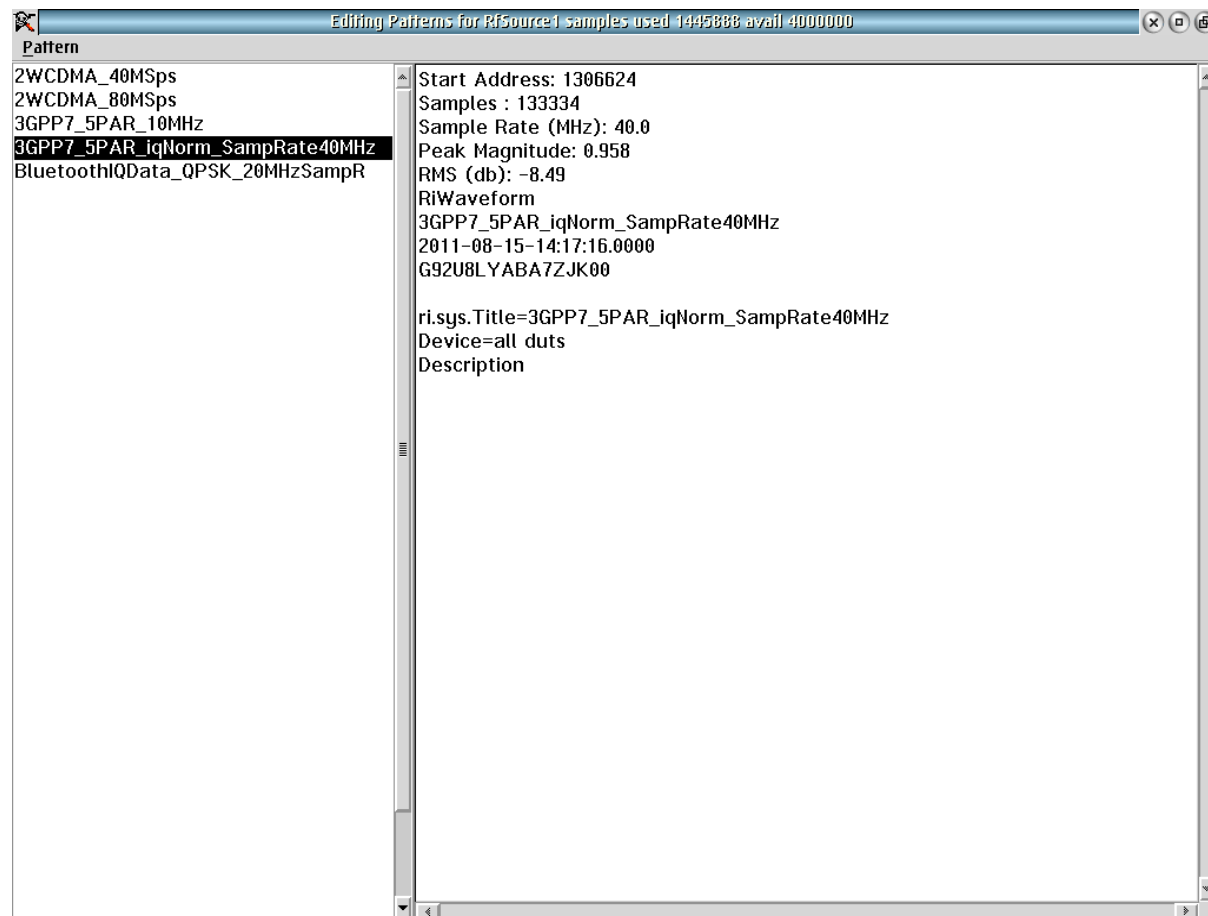
*NOTE: “Output1” and “Output2” can only be defined by a fixture definition.*



## EDIT PATTERNS

This button displays the current waveform/pattern loaded into the RfSource's complex baseband I/Q modulator. A left mouse click on the button opens the Edit Patterns window as shown in [Figure 2.1](#). The left pane of the Edit Patterns window displays a list of all waveforms that have been loaded into the instruments on-board memory. Selecting any of these waveforms with a left-mouse button displays more information in the right pane: start address in memory,

FIGURE 2.1 EDIT PATTERNS DIALOG



number of samples, sample clock rate, peak magnitude, RMS magnitude in dB, and information about the original waveform file from Guru. New waveforms can be added to the list by selecting **Pattern > add from Guru** from the menu options. The user can then select a waveform from Guru and specify additional information.

*NOTE: Waveforms are programmed into memory sequentially. While waveforms can be removed from the list view by selecting them and using the menu option "Pattern > remove", they are not erased from the memory. To make used memory available again, all waveforms must be purged using the "Pattern > Erase > All Patterns" menu option.*

## aux In

This drop down list selection button allows the user to select from predetermined routing built into the source. These connections are managed by the user by making sure both ends of a desired path are selected when use in a test plan.

An example is show below:

Path: RFSource1-aux In - Internal RF input  
base name: auxIn

## Aux In

This drop down list selection button allows the user to select from predetermined routing built into the source. These connections are managed by the user by making sure both ends of a desired path are selected when use in the pest plan.

An example is show below:

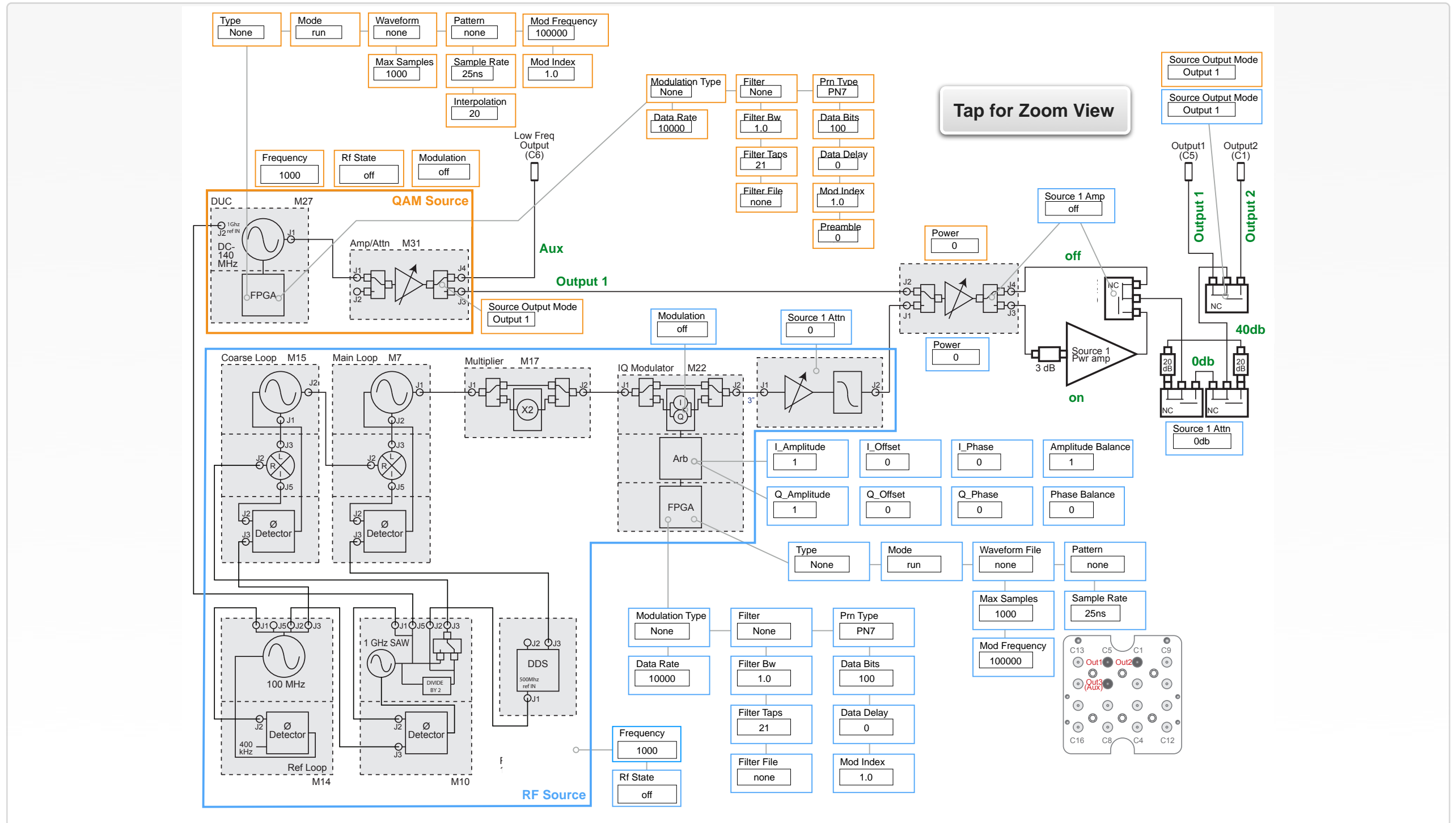
From : RFSource1-Internal RF input  
base name: AuxIn

To : QamSource1-Internal  
RF output- internal:  
base name: AuxOut  
type: internal

Path : RfSource1-Internal  
RF input: QamSource1-Internal  
RF Output- internal

*NOTE: The 'aux In' and 'Aux In' resource configurations of the RfSource instrument are managed automatically in [Cassini 16 ATE systems](#), but must be defined by the user in a testplan when using the [Small Cassini ATE systems](#).*

## INSTRUMENT BUTTON DIAGRAM 2.2

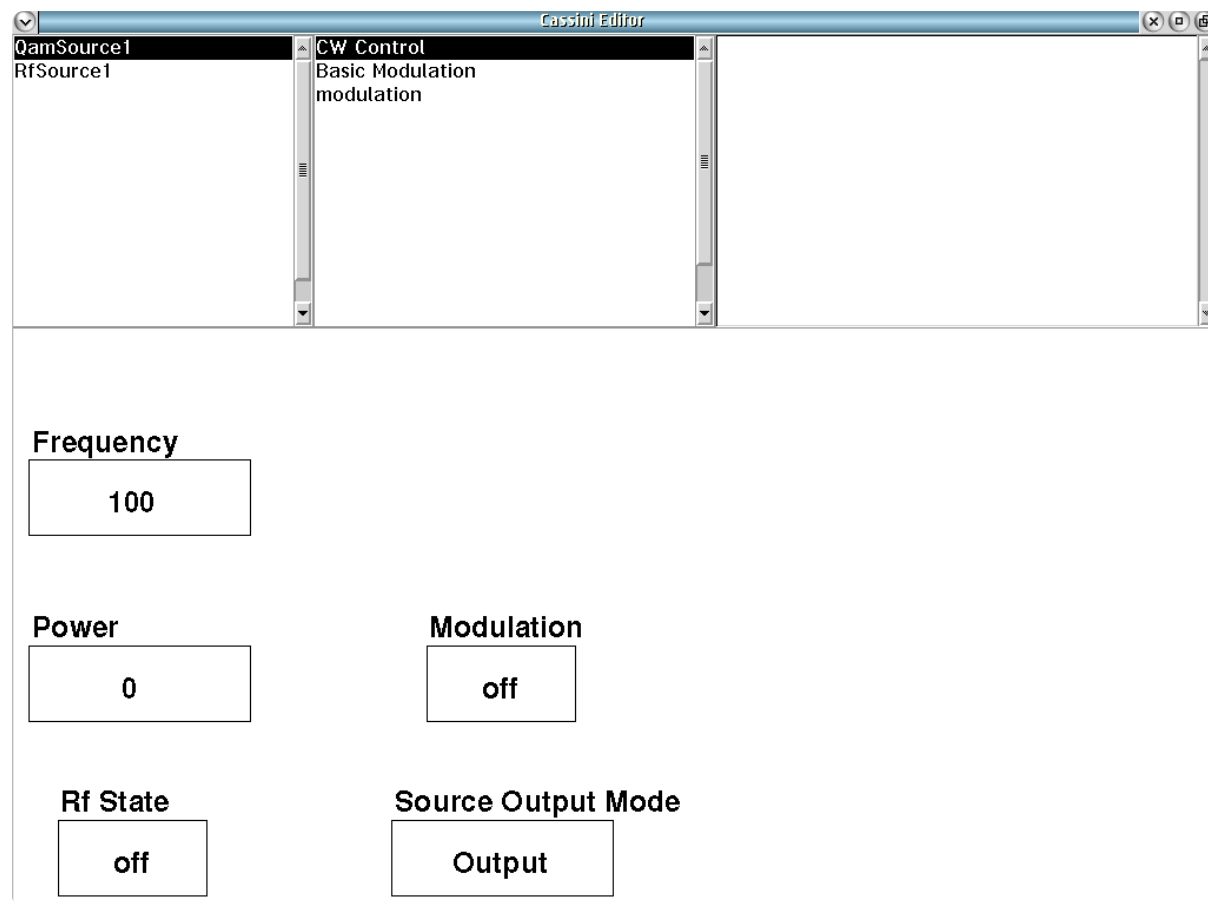


Button modes are shown in green text next to their associated function or signal path designation.

## EDIT PANELS

The RI8508 edit panel or editor window provides instrument function blocks and state buttons for QamSource1 and RfSource1. These button and blocks, used in Cassini’s graphical test programming environment, are defined in the following text.

### EDIT PANELS 2 RI8508: QAMSOURCE EDIT PANELS



**QamSource1** buttons used for Continuous Wave (CW) controls in a Test Panel.



## QAMSOURCE1

QamSource1 contains CW Control, Basic Modulation and modulation subsystem panels.

### CW CONTROL EDIT PANEL

#### Frequency

A decimal notation input button in units of that sets the QamSource signal frequency. The valid input range is 100 to 400 (100MHz to 400MHz) in 1 Hz steps.

Frequency

#### Power

A decimal notation input button in units of dBm that set the desired power at the device. The valid range of values is -60 to 10 (+10 dBm to > -60 dBm).

Power

**Rf State**

off

**Rf State**

A drop down list button that sets the output power level control of the QamSource instrument.

The 'off' state sets the power level control to the highest attenuation value of ~60 dB.

The 'on' state sets the power level control to the lowest attenuation value of ~0 dB.

*NOTE: The amount of attenuation in the 'off' state is dependent on the signal level set by the Power button, i.e. if the Power button is set to +10 dBm then the Rf State 'off' value will be ~60 dB lower = -50dBm; If the Power button is set to -50 dBm, the Rf State 'off' would only be ~10 dB lower (-60dB). To completely remove the source signal contribution, the test plan should switch the source signal to an unused path in the TIM or Fixture, avoiding mechanical switching which have a finite lifetime due to wear.*

**Modulation**

off

**Modulation**

A drop down list button that modulates the QamSource carrier tone set by the **Frequency** and **Power** buttons.

The 'on' state modulates the internal arbitrary waveform generator with the main signal output.

The 'off' state disconnects the internal arbitrary waveform generator from the main signal output.

**Source Output Mode**

Output 1

**Source Output Mode**

A drop down list button that routes signal from the QamSource between the output ports.

The 'Output 1' selections routes signal out of the *Output1 (C5)* port.

The 'Output 2' selections routes signal out of the *Output2 (C1)* port.

The "Aux" selection routes signal to the *Low Freq Output (C6)* port.



## BASIC MODULATION EDIT PANEL

Max Samples

1000

### Max Samples

An integer value button that sets the number of desired samples per computed waveform. The maximum number of samples is 4000.

Mod Frequency

100000

### Mod Frequency

A decimal notation input button that sets the QamSource modulation frequency in units of Hz.

Mod Index

1.0

### Mod Index

A decimal notation input button that sets the ratio of the excursions of the modulated signal to the signal level of the unmodulated carrier in the time domain.

Type

None

### Type

A drop down list button that selects a modulation type from built-in waveforms.

The 'none' selection is the default value for no modulation type selected.

The 'Quad' selection generates two sine waves that are 90° phase coherent at a frequency set by the **Mod Frequency** button. It is modulated onto the carrier signal set by the **Frequency** and **Power** buttons.

The 'File' selection uses a waveform file selected by the **Waveform File** button. It is modulated onto the carrier signal set by the **Frequency** and **Power** buttons.

The 'Pattern' selection uses a modulation waveform selected by the **Pattern** button. It is modulated onto the carrier signal set by the **Frequency** and **Power** buttons.

The 'Modulation' selection generates a modulation set by the buttons in the 'modulation' Editor Panel: **Modulation Type, Data Rate, Data Bits, Prn Type, and Preamble Bits**. It is modulated onto the carrier signal set by the **Frequency** and **Power** buttons.

The 'FM Tone' selection generates a single frequency (tone) modulation. The toned (single frequency) modulating signal consists

of only one frequency component set by the **Mod Frequency** button and is modulated onto the carrier signal set by the **Frequency** and **Power** buttons.

The 'FM Stereo' selection generates an FM modulated signal with a left (L) and right (R) channel encoded as sum (L+R) and difference (L-R) signals set by the **Mod Frequency** button, onto the carrier set by the **Frequency** and **Power** buttons.

The FM Stereo Left selection generates the FM Stereo signal with only the left channel encoded onto the carrier. The modulation frequency is set by the **Mod Frequency** button with the carrier set by the **Frequency** and **Power** buttons.

#### Interpolation

20

### Interpolation

A decimal notation input button that sets the data interpolation of the modulation signal.

*NOTE: The interpolation sample rate is  $\frac{250 \text{ MHz}}{x}$ , where  $3.0 \leq x \leq 63.0$ .*

#### Mode

run

### Mode

Drop down list button that controls the pattern or waveform emit from the QamSource instrument.

The 'run' value is used in global or section defaults or within a test panel to initiate a waveform.

The 'stop' value is used in global or section defaults or within a test panel to cease a waveform.

The 'pmStart' value is used to trigger a burst of the waveform with a precision start time designated by the user within a test panel using a pre-measure sequence grouping.

The 'pmStop' value is used to trigger the end of a waveform burst with a precision stop time designated by the user within a test panel using a post-measure sequence grouping.

The 'trigger' value is used to start a waveform burst with a pre-set start time of 0 and is terminated by the user within a test panel using a 'pmStop' in the post-measure sequence grouping.

*NOTE: 'pmStart' and 'pmStop' must be used together within a test panel for the desired result of syncing the waveform with an event or user start time.*

## Pattern

A drop down list button that selects the name of the desired pattern from the instrument's preloaded internal memory.

Pattern

none

## Waveform File

Drop down list button that selects a waveform from the preloaded user-defined waveforms on the instrument.

Waveform File

none

## MODULATION EDIT PANEL

### Filter

A drop down list button that selects a digital filter type to be applied to the waveform. Built-in types include: "Raised Cosine", "Gaussian", "GMSK", or a user-defined filter type provided with the **Filter File** button.

Filter

None

### Filter Shape

A decimal notation input button that sets the Filter Shape Factor.

Filter Shape

0.0

*NOTE: This button is dependent on the filter type defined with the Filter button.*

### Filter Bw

A decimal notation input button that sets the desired ratio of the selected digital filter's bandwidth to the symbol bandwidth.

Filter Bw

1.0

### Filter Taps

A drop down list button that selects the file name of a user-defined digital filter taps or coefficients file.

Filter Taps

5.0

### Data Bits

An integer value button that sets the number of data symbols per record.

Data Bits

100

### Data Rate

A decimal notation input button that sets the output data rate in symbols per second.

Data Rate

100000

### Modulation Type

A drop down list button that selects the type of base modulation to generate. i.e “8PSK” or 8-Symbol Phase Shift Keying

Modulation Type

none

### Filter File

A drop down list button that selects the file name of a user-defined digital filter taps or coefficients file.

Filter File

none

### Prn Type

A drop down list button that selects the size of the pseudo random number seed used in the sequence generator. i.e “PN5”, “PN7”, “PN9” etc.

Prn Type

PN7

### Data Delay

A decimal notation input button that sets a delay of the output modulation in units of seconds. It is used in conjunction with the **Mode**: ‘pmStart’ button setting.

Data Delay

0

Preamble Bits

0

## Preamble Bits

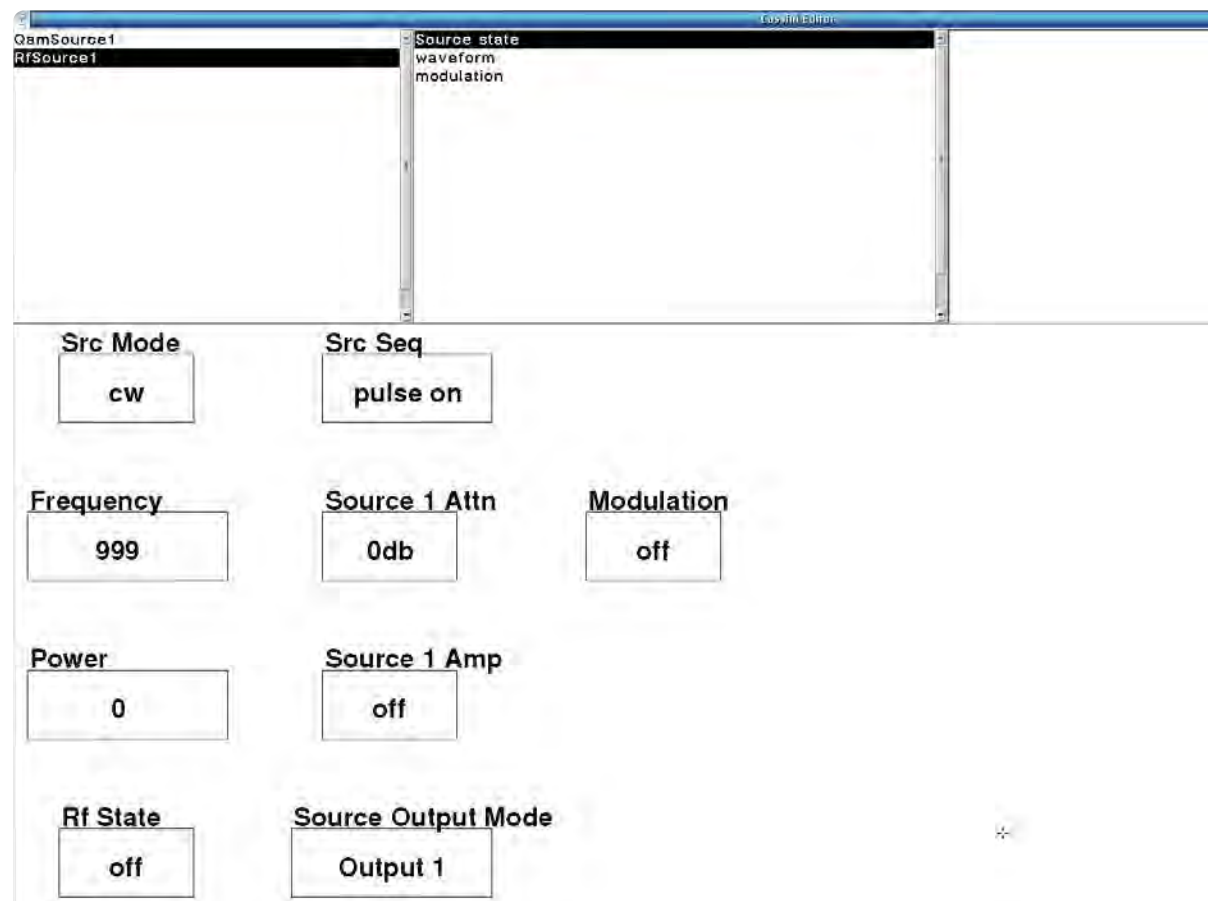
An integer value button that sets the number of alternating “1’s” and “0’s” output at the beginning of a waveform.



## RFSOURCE1

RfSource1 contains Source State, waveform and modulation panels.

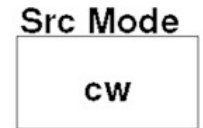
### EDIT PANELS 3 RI8508: RFSOURCE EDIT PANELS



RfSource1 buttons used for basic source state control including frequency and power.



## SOURCE STATE EDIT PANEL

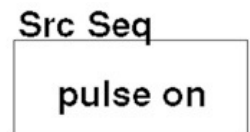


### Src Mode

A drop down list button that enables continuous wave or pulsed operation.

‘cw’ is the default value and provides continuous wave operation.

‘pulse’ value enables a pulsed or burst RF mode. In this setting, the **Src Seq** button controls the on/off state of the pulsed signal output.



### Src Seq

A drop down list button that controls the on/off state of a pulsed RF signal by controlling the state of an internal relay with microsecond switching speed. It is used in conjunction with the **Src Mode** button with the ‘pulse’ button setting.

*NOTE: The button must be placed in a pre-measure or post-measure group to control the RF on or off pulse setting.*

‘pulse on’ connects the internal relay to the source’s output port specified by the **Source Output Mode** button with the frequency and

power parameters defined by the **Frequency** and **Power** button settings.

'pulse off' disconnects the source from the output port to create the off setting.

*NOTE: The "pulse off" setting of the relay provides approximately -40 dB of isolation/attenuation of the Power button setting to create the pulse off condition.*

**Frequency**

999

## Frequency

A decimal notation input button that sets the RfSource center frequency in units of MHz. The valid input range is 1 to 6000 (1MHz to 6GHz) in 1 Hz steps.

**Power**

0

## Power

A decimal notation input button in units of dBm that sets the RF power. The valid input range is -60 to 10 (-60dBm to +10dBm) in 0.1dB steps.

**Rf State**

off

## Rf State

A drop down list button that sets the output power level control of the RfSource instrument.

The 'off' state sets the power level control to the highest attenuation value of ~60 dB.

The 'on' state sets the power level control to the lowest attenuation value of ~0 dB.

*NOTE: The amount of attenuation in the 'off' state is dependent on the signal level set by the Power button, i.e. if the Power button is set to +10 dBm then the Rf State 'off' value will be ~60 dB lower = -50dBm; If the Power button is set to -50 dBm, the Rf State 'off' would only be ~10 dB lower (-60dB). To completely remove the source signal contribution, the test plan should switch the source signal to an unused path in the TIM or Fixture, avoiding mechanical switching which have a finite lifetime due to wear.*

### Source 1 Attn

A drop down list button that provides an option for connecting a calibrated 40 dB attenuator internally to the RF source output path for increased low-end dynamic signal range.

Source 1 Attn

0db

### Source 1 Amp

A drop down list button that in the “on” state connects an internal 20dB gain amplifier into the output path. The linear amplification range is between 400 MHz to 6 GHz. This button is used to boost the high-end dynamic signal range, typically used for **Power** button settings request of greater than +7dBm.

Source 1 Amp

off

### Source Output Mode

A drop down list button that routes signal from the RfSource instrument between the output ports.

The ‘Output 1’ selections routes signal out of the *Output1 (C5)* port.

The ‘Output 2’ selections routes signal out of the *Output2 (C1)* port.

Source Output Mode

Output 1

The “Aux” selection routes signal to the *Low Freq Output (C6)* port.

### Modulation

A drop down list button that modulates the Rfsource carrier tone set by the **Frequency** and **Power** buttons.

The ‘on’ state modulates the internal arbitrary waveform generator with the main signal output.

The ‘off’ state disconnects the internal arbitrary waveform generator from the main signal output.

Modulation

off

**WAVEFORM EDIT PANEL****I\_ Amplitude**

1

**I\_ Amplitude**

A decimal notation input button in units of volts that sets the peak voltage for the in-phase component of the output waveform. Range is 0 V to 3 V peak.

**I\_ Offset**

1

**I\_ Offset**

A decimal notation input button in units of volts that sets the DC offset voltage for the in-phase component of the waveform. Range is  $\pm 3$  V.

*NOTE: Output waveform + DC offset cannot exceed 3 volts.*

**I\_ Phase**

0

**I\_ Phase**

A decimal notation input button in units of degrees that sets the phase delay of the in-phase component of the waveform.

**Amplitude Balance**

1

**Amplitude Balance**

A decimal notation input button that sets the gain ratio between the in-phase and quadrature waveforms.

**Q\_ Amplitude**

1

**Q\_ Amplitude**

A decimal notation input button in units of volts that sets the peak voltage for the quadrature component of the output waveform. Range is 0 V to 3 V peak.

**Q\_ Offset**

1

**Q\_ Offsets**

A decimal notation input button in units of volts that sets the DC offset voltage for the quadrature component of the waveform. Range is  $\pm 3$  V.

*NOTE: Output waveform + DC offset cannot exceed 3 volts.*

**Q\_Phase**

A decimal notation input button in units of degrees that sets the phase delay of the quadrature component of the waveform.

Q\_Phase

0

**Phase Balance**

A decimal notation input button that sets the phase ratio between the in-phase and quadrature waveforms.

Phase Balance

0

**Sample Rate**

A drop down list button that sets the waveform data point output rate. Data point output sample rates options are “1  $\mu$ sec”, “100 nSec”, “50 nSec”, “31.25 nSec”, “25 nSec”, and “12.5 nSec” corresponding to “1 MHz”, “10 MHz”, “20 MHz”, “32 MHz”, “40 MHz”, and “80 MHz” respectively.

Sample Rate

25ns

*NOTE: Waveform data point sample rates must comply with one of these listed sample rates. “Pattern” files have a maximum sample rate of “31.25 nSec” or “32 MHz.”*

**Max Samples**

An integer value button that sets the maximum number of samples per waveform.

Max Samples

1

*NOTE: “Max Samples” only applies to non Waveform or Pattern type signal files. Maximum number of samples is 4000.*

**Mod Frequency**

A decimal notation input button that sets the modulation frequency for the built-in standard waveform types. This frequency is converted to the data rate.

Mod Frequency

100000

**Type**

A drop down list button that selects from the built-in modulation waveform standards: “Tone”, “Quad”, “Sine”, “Quad Mod Test”, and “Square Wave”. “File” and “Pattern” instructs the compiler to use a

Type

none



user-defined modulations from either a supplied file, or one-built with buttons from the Modulation builder.

### Waveform File

A drop down list button that selects a waveform from a pre-loaded file at run time.

**Waveform File**  
none

### Pattern

A drop down list button that selects the name of a user-defined pattern loaded into internal memory.

**Pattern**  
none

### Mode

Drop down list button that controls the pattern or waveform emit from the RfSource instrument.

The 'run' value is used in global or section defaults or within a test panel to initiate a waveform.

The 'stop' value is used in global or section defaults or within a test panel to cease a waveform.

**Mode**  
run

The 'pmStart' value is used to trigger a burst of the waveform with a precision start time designated by the user within a test panel using a pre-measure sequence grouping.

The 'pmStop' value is used to trigger the end of a waveform burst with a precision stop time designated by the user within a test panel using a post-measure sequence grouping.

The 'trigger' value is used to start a waveform burst with a pre-set start time of 0 and is terminated by the user within a test panel using a 'pmStop' in the post-measure sequence grouping.

*NOTE: 'pmStart' and 'pmStop' must be used together within a test panel for the desired result of syncing the waveform with an event or user start time.*

## MODULATION EDIT PANEL

### Filter

A drop down list button that selects a digital filter type to be applied to the waveform. Built-in types include: “Raised Cosine”, “Gaussian”, “GMSK”, or a user-defined filter type provided with the FilterFile button.

Filter

none

### Filter Bw

A decimal notation input button that sets the ratio of the selected filter’s bandwidth with the symbol bandwidth.

Filter Bw

1.0

### Filter Taps

Decimal notation input button that sets the total number of digital filter coefficients.

Filter Taps

5.0

### Mod Index

A decimal notation input button that sets the ratio of the excursions of the modulated signal to the level of the unmodulated carrier.

Mod Index

1.0

### Data Bits

Decimal notation input button that sets the number of data points per record.

Data Bits

100

### Data Rate

Decimal notation input button that sets the output data sample rate.

Data Rate

100000

### Modulation Type

A drop down list button that selects a modulation from the built-in standards: “Ran FSK” - Random Frequency Shift Keying, “8PSK” - 8 Symbol Phase Shift Keying, “Edge”, “QPSK” Quadrature Phase Shift Keying, “FM Tone”, and “AM Tone”

Modulation Type

none

## Filter File

A drop down list button that selects the file name of a user-defined digital filter. The filter coefficients should be normalized to unity gain.

Filter File

none

## Prn Type

A drop down list button that selects the size of the pseudo random number seed used in the sequence generator. i.e “PN5”, “PN7”, “PN9”, etc.

Prn Type

PN7

## Data Delay

A decimal notation input button that sets a delay of the output modulation in units of seconds. It is used in conjunction with the **Mode**: ‘pmStart’ button setting.

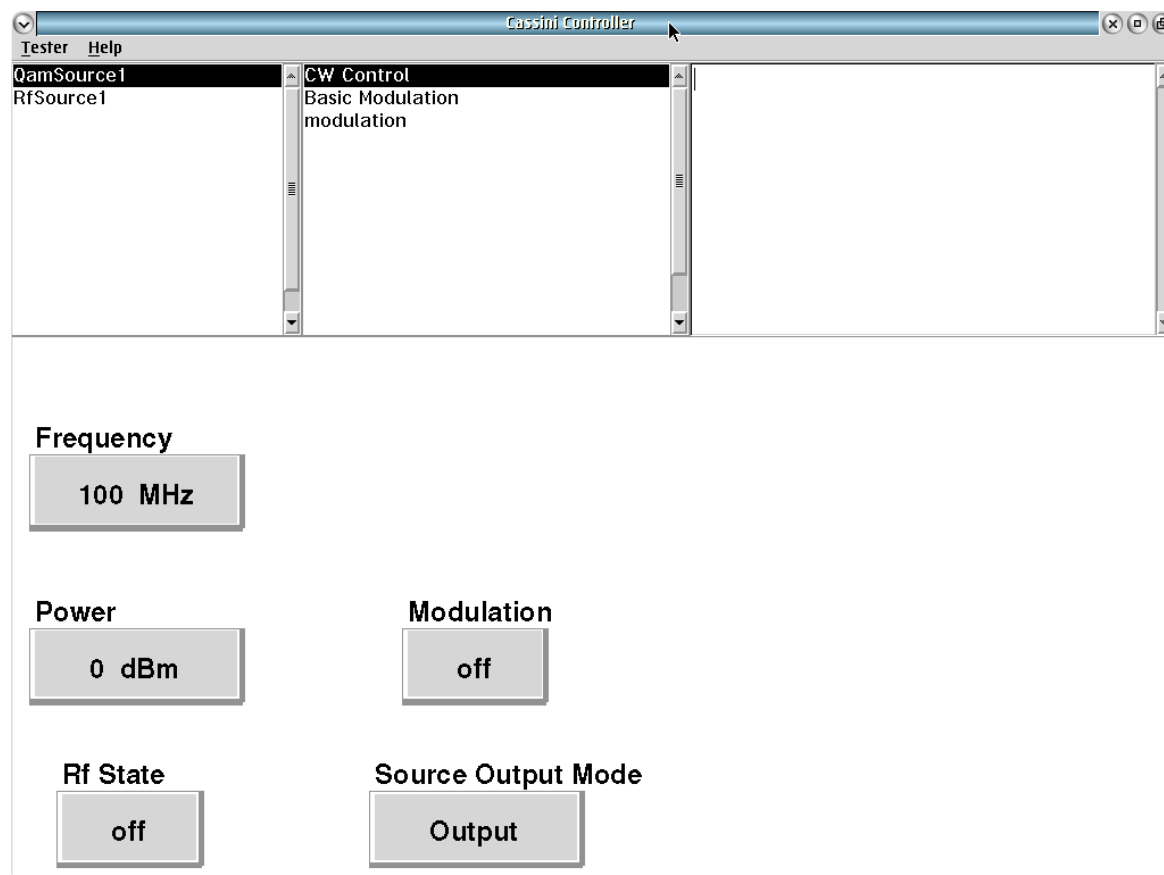
Data Delay

0

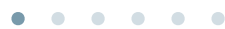
## CONTROL PANELS

The control panel provides a direct view and control of RI8508 instrument settings much like the view and controls of bench-top equipment. This panel is also used for in-situ view and control of the

### CONTROL PANELS 2 RI8508 CONTROL PANELS



QamSource1 provides real-time interaction with the continuous wave (CW) buttons.



instruments at a breakpoint within a running test plan or measurement.

## QAMSOURCE1

QamSource1 contains CW Control, Basic Modulation and modulation panels.

### BASIC MODULATION CONTROL PANEL

This panel provides the ability to control the modulation waveform voltage and delay (phase) independently to the in-phase and quadrature component signals of the modulator.

#### I\_ Amplitude

A decimal notation input button in units of volts that sets the peak voltage for the in-phase component of the output waveform. Nominal is 1 Volt.

#### I\_ Offset

A decimal notation input button in units of volts that sets the DC offset voltage for the in-phase component of the waveform.

#### I\_ Phase

A decimal notation input button in units of degrees that sets the phase delay of the in-phase component of the waveform.

## Q\_ Amplitude

A decimal notation input button in units of volts that sets the peak voltage for the quadrature component of the output waveform. Nominal is 1 Volt.

## Q\_ Offset

A decimal notation input button in units of volts that sets the DC offset voltage for the quadrature component of the waveform.

## Q\_ Phase

A decimal notation input button in units of degrees that sets the phase delay of the quadrature component of the waveform.

## RFSOURCE1

RfSource1 contains RF Control, waveform and modulation panels.

### RF CONTROL PANEL

---

An information only display button grouping is provided.

### RfSource1 Group

This group provides a view of the actual internal RfSource parameters settings, independent of any system wide frequency offsets or path loss power corrections.

*NOTE: This view is useful when debugging the entire Tester, Test Fixture and Device Interface Board path.*

## WAVEFORM CONTROL PANEL

### Offset Frequency

A decimal notation input button in units of Hz that offsets the Frequency of the waveform output.

*NOTE: Amplitude values and offsets for the in-phase and quadrature voltages and phase must be set in the test plan/program. There is no real-time control available for these settings.*



# RI8535: UNIVERSAL DIGITAL



## TOPICS

---

[Instruments Provided by this TIM](#)

[Configuration Panels](#)

[Edit Panel Button Descriptions](#)

[Control Panel](#)

Tap the links above to quickly access content.

## INSTRUMENTS PROVIDED BY THIS TIM

This TIM provides digital pins in banks of 20 up to a possible 120 in a single TIM. The instruments in this TIM appear as **DPins1**, **DPins2**, ... **DPins6** in the panel dialog windows. Additional TIMs appear as DPins1\_#, where the “#” represents the 2nd, 3rd, etc... TIM.

Model and Name as it appears in the Tester Configuration:

- Dpins1, Ri8535x Cassini Digital D1

*NOTE: The “x” in the model number denotes the revision of the instrument. If there are more than one digital TIM in the configuration, then an underscore followed by an enumeration is appended to the Owner Name, i.e - DPins1\_2, DPins2\_2, etc.*

*The number of pin cards in a Digital TIM are as listed below:*

*RI8535B2 - 20 pin model*

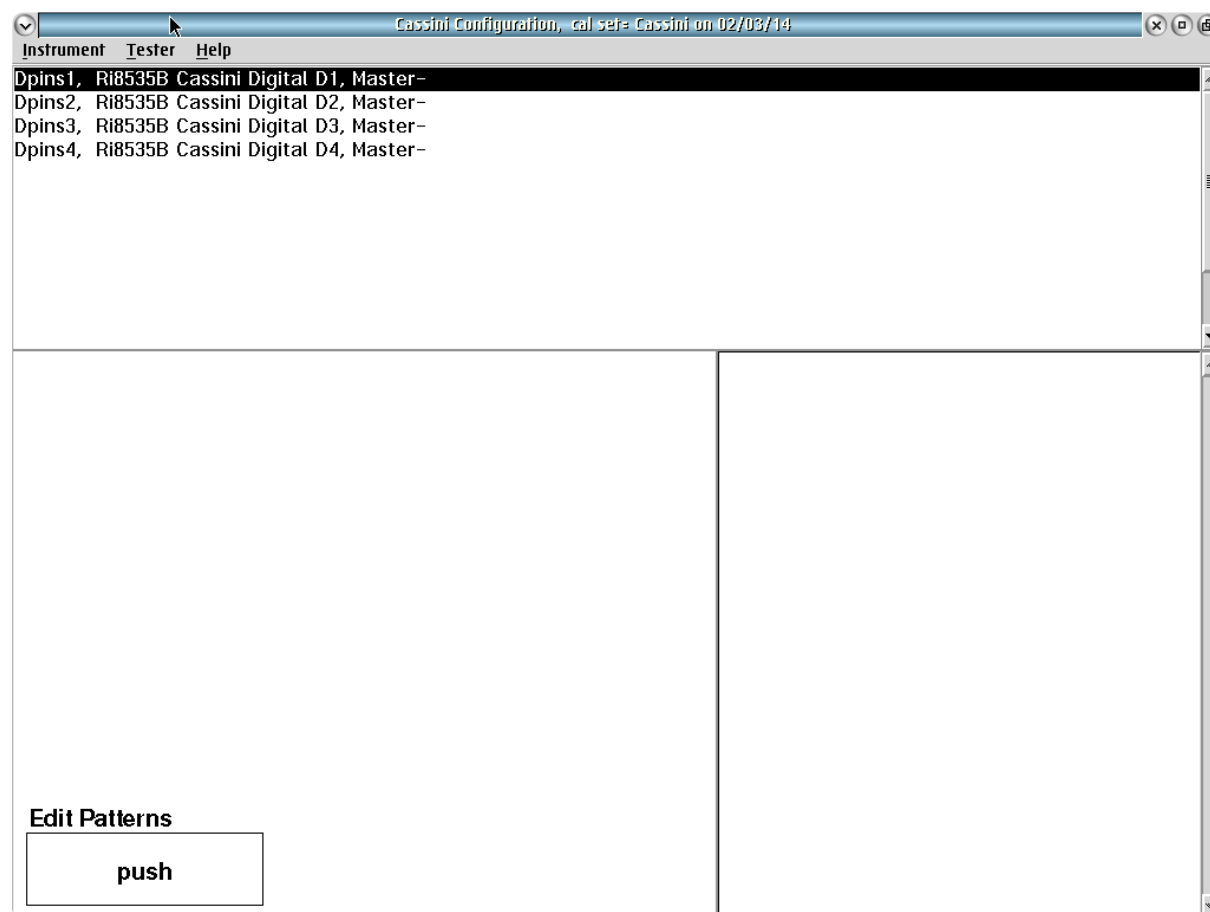
*RI8535B1 - 40 pin model*

*RI8535B0 - 80 pin model*

## CONFIGURATION PANELS

The configuration panel displays the number of digital pin cards in the TIM and loaded patterns in the RI8535's on-board FPGAs.

### CONFIGURATION PANELS 3 RI8535 UNIVERSAL DIGITAL



Digital patterns can be loaded for each Dpins# instrument

## DPINS1

Each Dpins instrument denotes a 20-pin digital card.

### EDIT PATTERNS

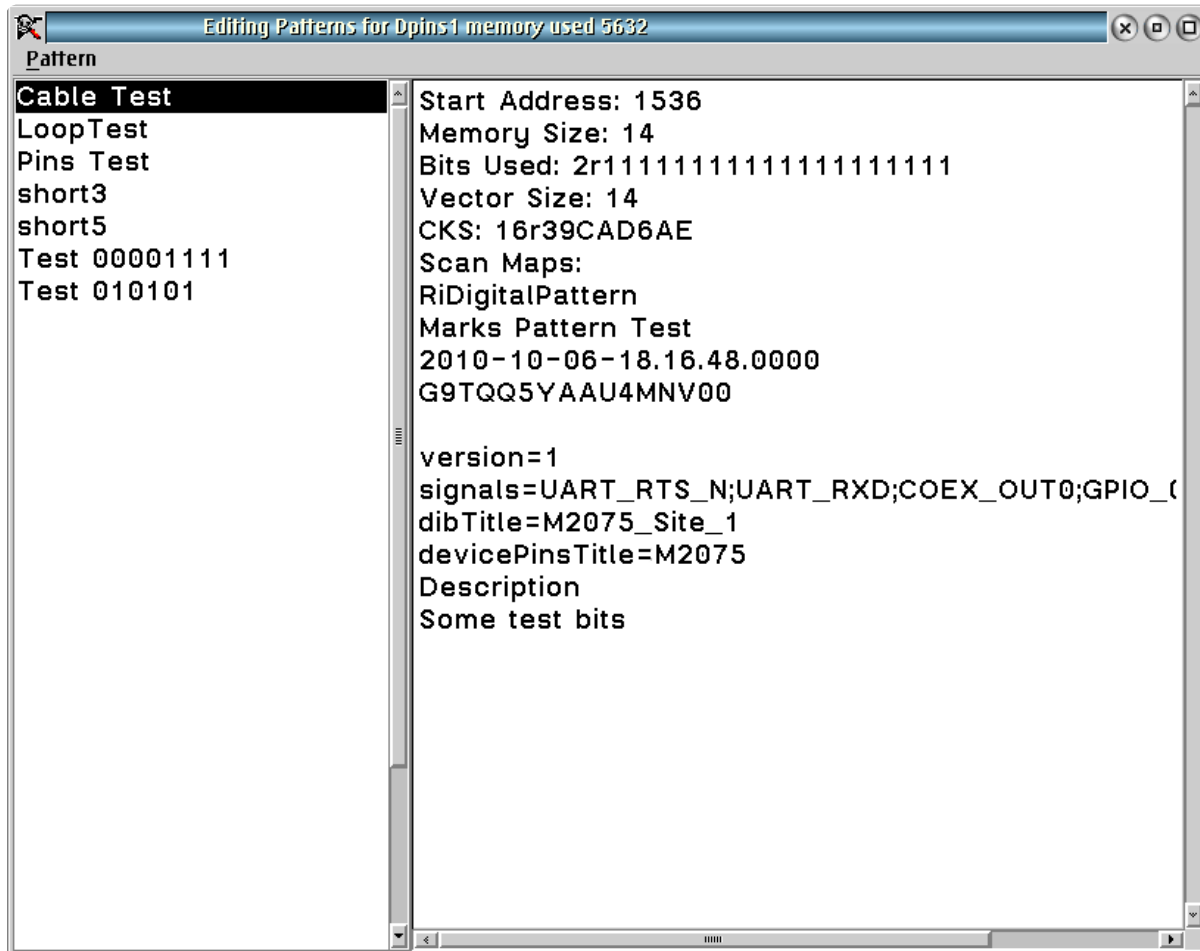
The **Edit Patterns** button views and loads digital patterns into the specified *Dpins* instrument's onboard-FPGA.

*NOTE: The Digital Translate application found under the Apps button in the Guru bar, imports logic patterns from a WGL (STIL), ATP or CSV file into Guru.*

To load a digital pattern in the *Dpins* instrument:

1. In a System Configuration window, left click on the target Dpins instrument to highlight it.
2. With the Dpins instrument highlighted, in the lower pane of the Configuration window, left mouse click on the **Edit Patterns:** 'Push' button to open the Editing Patterns window.
3. Select 'Patterns' > 'add from Guru' from the menu options.
4. In the Editing Patterns window, from the menu options select Pattern > 'add from guru' to open the Pick Pattern Window.
5. Select the desired pattern from the list and click **OK** to load.
6. The selected pattern will appear in the Editing Patterns window.

FIGURE 2.2 EDIT PATTERNS DPINS DIALOG



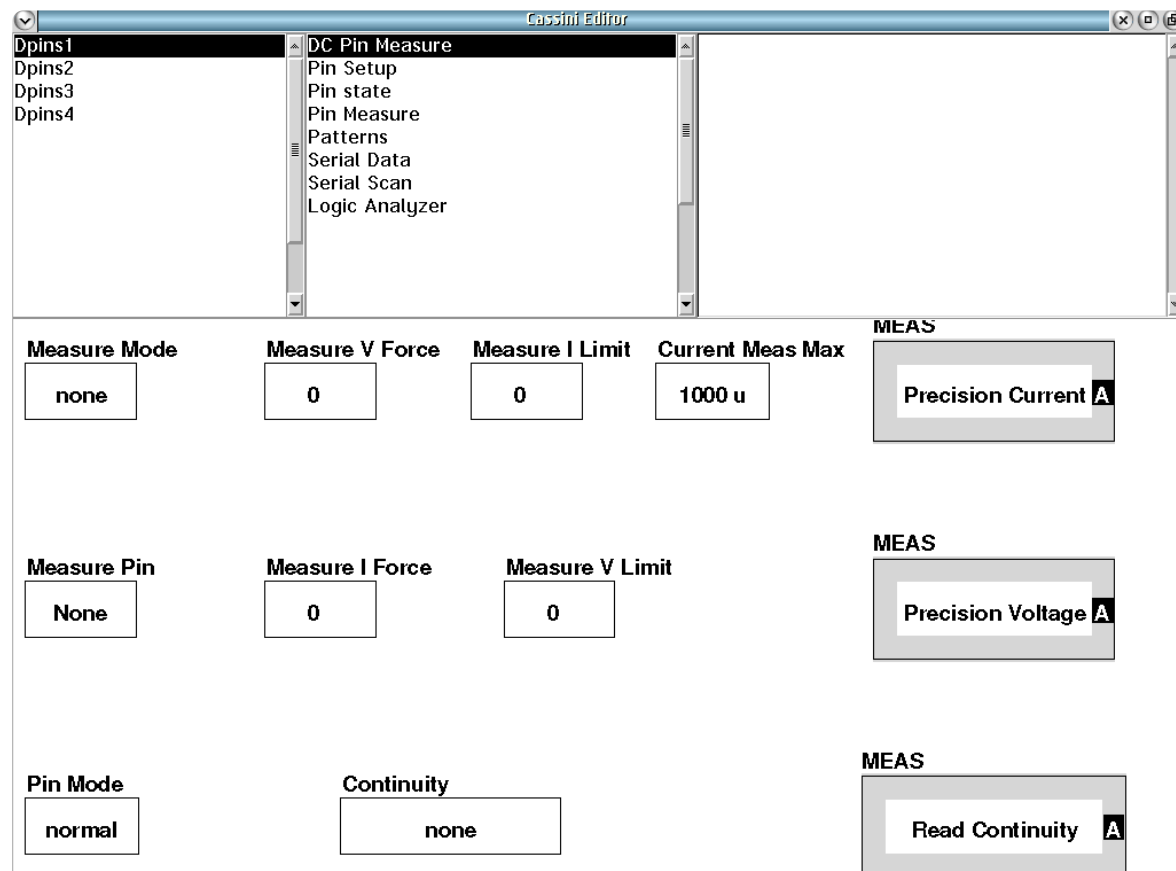
Multiple patterns are displayed in the left pane with information displayed in the right pane for the selected pattern.

*NOTE: The digital pattern is saved into the Dpins on-board FPGA. This process must be repeated to load new or updated patterns.*

## EDIT PANELS

The RI8535 edit panel or editor window provides instrument function blocks and state buttons for a Dpins instrument consisting of 20-pin digital resources. These button and blocks are used in Cassini's

### EDIT PANELS 4 RI8535 UNIVERSAL DIGITAL EDIT PANELS



DC Pin Measure provides multimeter and continuity resources and measurement blocks.

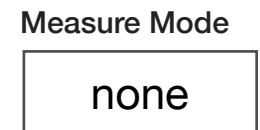


graphical test programming environment and are defined in the following text.

## DPINS1

Each Dpins# (1 thru 6) instrument contains contains DC Pin Measure, Pin Setup, Pin State, Pin Measure, Patterns, Serial Data, Serial Scan, and Logic Analyzer subsystem panels.

### PANEL: DC PIN MEASURE



#### Measure Mode

A drop down list button that sets the measurement mode of the selected pin set by the **Measure Pin** button.

'none' is the default mode and disconnects all measurement resources from the designated pin.

'Voltmeter' provides precision voltage measure with a high series resistance (1MΩ).

The 'I meas' selection forces a voltage defined by the **Measure V Force** button and measures the resulting current for the selected resource using the **Measure Pin**. The **Measure I Limit** button restricts the maximum amount of current delivered by the supply



during the measurement to avoid damaging the device pin if there is a DUT failure.

*NOTE: The Pin Mode button must be set to 'continuity' to use this mode.*

The 'vMeas' selection forces a current defined by the **Measure I Force** button and measures the resulting voltage for the selected resource using the **Measure Pin**. The **Measure V Limit** button restricts the maximum voltage applied during the measurement. Typically the **Measure V Limit** button is set to the DUT's supply rail or ground depending on the polarity of the **Measure I Force** button to avoid damaging the device pin.

*NOTE: The Pin Mode button must be set to 'continuity' to use this mode.*

The 'low Current' selection measures the current for a selected resource defined by the **Measure Pin**. This mode sets use a high-precision sense resistor to access the lowest current measurement range possible and incorporates a built-in, recursive averaging method to measure DC currents in the pA range.

*NOTE: The Pin Mode button must be set to 'leakage' to use this mode.*

The 'vCal' selection is the same mode as the 'vMeas' mode with the exception that the current limit settings are deactivated. The value set with the **Measure I Limit** is ignored, and the supply will deliver as much available current as the internal supply can force to set the voltage defined by the **Measure V Force** button.

*NOTE: This mode is typically used in continuity tests for device pins with large in-rush currents or long duration time constants during power up.*

*The Pin Mode button must be set to 'continuity' to use this mode.*

The 'iCal' selection is the same mode as the 'lmeas' mode with the exception that the voltage limit settings are deactivated. The value set with the **Measure V Limit** is ignored, and the supply will deliver as much available voltage as possible to force the current condition defined by the **Measure I Force** button.

*NOTE: The Pin Mode button must be set to 'continuity' to use this mode.*

---

**CAUTION:** *In the iCal mode the pin voltages can exceed the rail voltages of the device under test.*

---

The 'continuity+' mode forces a current and measures the voltage of a [Device Pin Group](#) designated by the **Continuity** button. The continuity state of the pin group is measured using the **Read**

**Continuity** measurement block with the **Pin Mode** button set to 'continuity.'

The 'continuity-' mode sinks a current and measures the voltage state of a [Device Pin Group](#) designated by the **Continuity** button. The continuity state of the pin group is measured using the **Read**

**Continuity** measurement block with the **Pin Mode** button set to 'continuity.'

Measure Pin

None

## Measure Pin

A drop down list button that selects the Digital Output pin to be connected to the *DPins* internal measurement module (PMU).

The 'none' selection disconnects the digital pin resource from all internal measurement resources.

'D1-1' through 'D1-20' selections connects the specified resource pin to the internal measurement resources specified by the **Measure Mode** and **Pin Mode** buttons.

Pin Mode

normal

## Pin Mode

A drop down list button that selects the internal resource to be connected to the resource pin designated by the **Measure Pin**

button. This button is commonly used in conjunction with the **Measure Mode** button.

'normal' connects an internal protection diode network to each of the Dpins to allow for standard voltage drive and digital read/write modes as the default pin mode.

'continuity' disconnects the protection diode network from the Dpins and offsets the internal measurement module to test for continuity voltage compliance within the range of +3V to -1.5V on all pins.

The 'leakage' mode disconnects the protection diode network from and all source and measurement resources from the Dpins to prevent stray leakage currents from affecting low current measurements. This mode is used in conjunction with the **Measure Mode** button in the 'lmeas' and 'low current' modes.

Measure V Force

0

## Measure V Force

Decimal notation button that sets the value of the voltage force condition for the **Measure Mode**: 'lmeas' setting. The condition is applied to the resource designated by the **Measure Pin** button. The values are in units of volts.

**Measure I Force**

0

**Measure I Force**

Decimal notation button that sets the value of the current force condition for the **Measure Mode**: 'vMeas' setting. The condition is applied to the resource designated by the **Measure Pin** button. The values are input in units of amps.

---

*CAUTION: Setting a value of 0 can cause unexpected or irregular current or voltage measurement conditions at the device pin.*

---

**Continuity**

none

**Continuity**

A drop down list button that selects a [Device Pin Group](#) used for continuity measurements. Pin groups are defined in the [Device Pins](#) tab of the [Device Connection Editor](#). The associated 'Dut' instrument must be active in the system configuration to be accessible to the **Continuity** button options. Reference the [Dut Instrument](#) section for information on how to add a 'Dut' instrument to the system configuration.

**Current Meas Max**

1000 u

**Current Meas Max**

Decimal notation input button that optimizes the dynamic range of the internal current measure module to within one of four sense resistor ranges: <2 mA, <200  $\mu$ A, <20  $\mu$ A, and <2  $\mu$ A (i.e. a button value of 500 mA will select the dynamic range to <2 mA for the ADC). This button is used with the **Measure Mode**: 'lmeas', 'iCal', or 'low Current' settings and **Measure Pin** buttons.

**Measure V Limit**

0

**Measure V Limit**

Decimal notation input button that sets the maximum voltage amplitude for the **Measure Mode**: 'vMeas' button setting. This setting voltage-limits the supply with a clamping diode when in current drive mode to prevent damaging a DUT pin from unwanted and/or excessive voltage caused by the **Measure I Force** button current criterion.

**Measure I Limit**

0

**Measure I Limit**

Decimal notation input button that sets the maximum current amplitude for the **Measure Mode**: 'lmeas' button setting. This setting

current-limits the supply to prevent damaging a DUT pin from unwanted and/or excessive current caused by the the **Measure V Force** button voltage criterion.

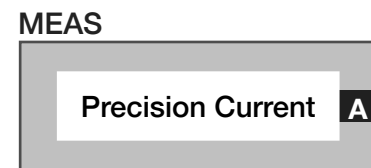
---

*CAUTION: Setting a value of 0 can cause unexpected or irregular current/voltage measurement conditions at the device pin.*

---

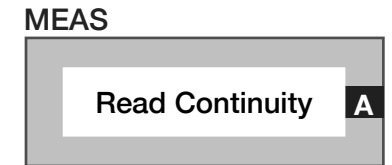
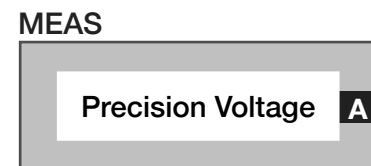
### Meas: Precision Current

Measurement block that computes the current at a resource pin designated by the **Measure Pin** button. The maximum measurable current is 2 mA. It is used with the **Measure Pin** and **Pin Mode**: 'continuity' or 'leakage' button settings.



### Meas: Precision Voltage

Measurement block that computes the current at a resource pin designated by the **Measure Pin** button. The maximum measurable voltage range is -3V to +5V. It is used with the **Measure Pin** and **Pin Mode** buttons.



### Meas: Read Continuity

Measurement block that uses an internal voltage comparator to compute the result of a continuity test. This measurement block is used in conjunction with the **Measure Mode**: 'continuity+' or 'continuity-', **Pin Mode**: 'continuity' and **Continuity** buttons. The results are provided for every pin in the [Device Pin Group](#) designated by the **Continuity** button. The value return by the measurement block is as follows:

A returned value of 0 is a "pass," denoting a measured voltage diode drop value between -1 to +3V, excluding 0V. For example, a measured voltage of 0.7V would be returned as 0 denoting a 'pass' value.

A returned value of 1 is a "short," denoting a measured voltage value of approximately 0V.

A returned value of 2 is an "open," denoting a measured voltage value of the rail conditions of -1V or +3V.

**PANEL: PIN SETUP****Vhigh**

A decimal notation input button that sets the voltage value for a logical '1' or 'high' condition for all Dpins in the 20-pin bank. The voltage range is 0 to +4V.

Vhigh

0

**Vlow**

A decimal notation input button that sets the voltage value for a logical '0' or 'low' condition for all Dpins in the 20-pin bank. The voltage range is 0 to +4V.

Vlow

0

**Vcompare**

A decimal notation input button that sets the voltage comparator condition for all Dpins in the 20-pin bank. The voltage comparator is used by data read functions and logical analyzer capture tools and is commonly used with buttons found in the *Serial Data*, *Pin Measure*,

Vcompare

4

and *Logic Analyzer* features of the Dpins. The comparator voltage set range is 0 to +4V.

**Vterm**

A decimal notation input button that sets the termination voltage condition. This button is used with the **D1-1** through **D1-20**: 'Vterm' button settings to set the voltage condition of the Dpins to a specified value. The voltage set range is 0 to +4V.

Vterm

0

**Vector Period**

Decimal notation input button that sets the clock period (clock rate) for any clock pins used for digital communication. The period is input in units of seconds with a maximum rate of 100MHz ('10 n' value).

For Scan Timing information, reference [Diagram 1](#) in the Appendix | Section 3: RI8535 Universal Digital.

Vector Period

25 n

**Clock Mode**

A drop down list button that selects the pin or pins in the 20-pin bank that will be used as clocks for digital communication protocols.

Clock Mode

normal



‘normal’ mode is the default mode and enables pins **5, 10, 15,** and **20** as clock pins.

‘off’ deactivates all pins

‘all’ allows all pins to be used as clock pins. In this mode, the **Clock Width, Data Stb,** and **Read Stb** button values are ignored (duty cycle adjustment and read/data offsetting are disabled).

‘d20’ designates pin 20 as the only clock in the Dpins bank of pins.

‘delay20’ mode is no longer supported.

Data Stb

-0.4

## Data Stb

A decimal notation input button that sets the leading edge offset of the data packet in seconds relative to the active edge of the clock. For entries greater than 0.01, the button input value is multiplied by the clock period value in the **Vector Period** button to generate the offset value. This button is used with the **Clock Mode:** ‘normal’ button setting.

*NOTE: A value less than 0 is recommended to provide adequate settling and rise/fall edge time alignment of the strobe signal caused by the device under test or interconnect.*

Read Stb

-0.1

## Read Stb

A decimal notation input button that sets the strobe offset in seconds relative to the active edge of the clock. For entries greater than 0.01, the button input value is multiplied by the clock period value in the **Vector Period** button to generate the offset value used. A value of 0 sets the strobe offset to zero, aligning the strobe’s active edge with the first active clock edge. This button is used with the **Clock Mode:** ‘normal’ button setting.

*NOTE: A value less than 0 is recommended to provide adequate settling and rise/fall edge time alignment of the strobe signal caused by the device under test or interconnect.*

Clock Width

0.4

## Clock Width

A drop down list button that sets the clock width (duty cycle of the clock) of the ‘active’ region. The default value of 0.4 represents a 40% active duty cycle. This button is used with the **Clock Mode:** ‘normal’ and **Vector Period** buttons.

*NOTE: Only pins 5, 10, 15, and 20 can adjust duty cycle using the Clock Width button setting.*

**PANEL: PIN STATE**

D 1-1

**D1-1 through D1-20**

A drop down list button that sets the pin state for static voltage or declares the logic type in a communication protocol.

'open' disconnects the specified *Dpin* from all internal logic drive and read resources.

'on' sets the pin to the voltage value specified by the **Vhigh** button.

'off' sets the pin to the voltage value specified by the **Vlow** button.

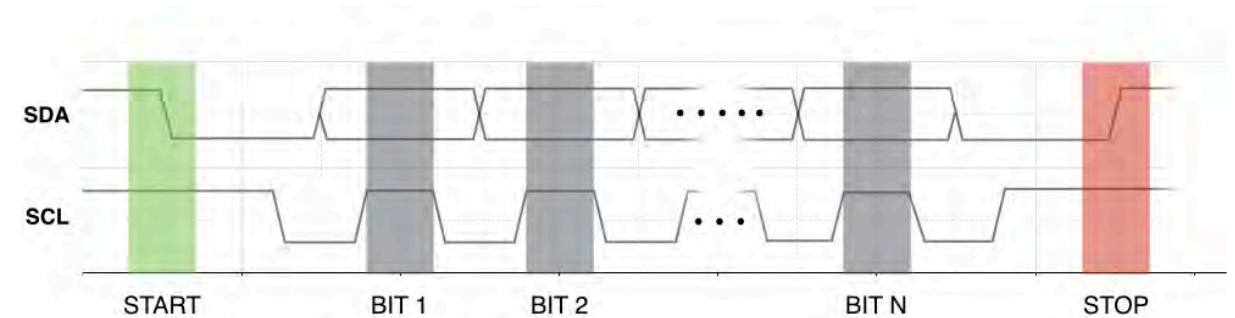
'clock' sets the pin as a clock driver output pin to provide a synchronous clock signal to an external device's clock input pin for various communication protocols. This setting is commonly used with the **Clock Mode**, and **Vector Period** buttons to designate the clock setup and speed as well as the **Read Size** button to designate the number of clock edges in a data read/write packet.

'/clock' sets the pin as a reversed value clock driver output pin to provide a synchronous clock signal to an external device's clock input pin for various communication protocols.

'sClk' sets the pin as a I<sup>2</sup>C protocol, clock driver output pin that aligns the clock duty cycle (rising and falling edge) to occur within the data bit duty cycle as shown in [Figure 2.3](#).

'data' sets the pin as an output pin to send data to an external

**FIGURE 2.3 sCLK MODE DATA/CLOCK TIMING DIAGRAM**



**The 'sClk' mode enforces the I2C protocol clock(SCL) and data(SDA) alignment.**

device's data input pin in synchronous communication protocols.

'aux' sets the pin as a generic output pin to send data to an external logic-based device's auxiliary pin in synchronous communication protocols.

'/aux' sets the pin as a reversed value, generic output pin to send data to an external device's auxiliary pin in synchronous communication protocols.

'strobe' sets the pin as a latch enable or strobe output pin to drive an external device's enable pin in synchronous communication protocols.

'/strobe' sets the pin as a reversed value latch enable or strobe output pin to drive an external device's enable pin in synchronous communication protocols.

'read' designates the pin as an input pin to capture data from the device under test, connecting an internal high impedance network to provide a suitable load. This setting is commonly used with the **Read Pin** button to designate a memory buffer for captured data.

'term' connects the designated pin to a series 50Ω resistor terminated with the voltage value specified by the **Vterm** button.

'r/w' sets the pin as a bilateral read/write pin to support an external flip-flop or other logic-based device's synchronous communication protocol. This setting is commonly used with the **Read Pin**, and **Read Size** buttons to designate a memory buffer for captured data as well as **Serial Data**, **Serial Type**, and **Serial Idle** buttons to designate data write information.

*NOTE: The Dpin used as a I<sup>2</sup>C bidirectional read/write pin must be set to 'r/w' to prevent data collisions.*

Pin State

none

## Pin State

A drop down list button that allows the user to select a pin group that sets the state of the pins in the *Dpins* bank according to the pin group's designations defined by a Device Pins Group of a **Device Pins** definition in the [Device Connection Editor](#). The associated device must be active in the system configuration to be accessible to the **Serial Group** and **Device Pins** button options. Reference the [Dut Instrument](#) section for information on how to add a device to the system configuration.

**PANEL: PIN MEASURE**

Measure Time

10 u

**Measure Time**

A decimal notation input button that sets the capture window of the frequency counter in units of seconds. This button is used in conjunction with the **Read Pin** button and **Pin Frequency** measurement block.

Read Pin

none

**Read Pin**

A drop down list button that connects internal measurement module resources for the designated pin. The measurement resource used is dependent on the additional buttons and/or blocks included in the testplan, with commonly used setups listed as follows:

Frequency counter resource includes the **Pin Mode**: 'normal' and **Measure Time** buttons with **Pin Frequency** measurement block.

The voltage comparator resource includes the **Pin Mode**: 'continuity' button and **Read Pin State** measurement block.

The internal read buffer resource used for synchronous communication protocols includes the **Pin Mode**: 'normal', **Read**

**Size**, **Read Polarity**, and **Read Delay** buttons with the **Read Serial** measurement block.

MEAS

Pin Frequency **A****Meas: Pin Frequency**

Measurement block that computes the frequency of the *Dpins* resource selected by the **Read Pin** button with a capture window set by the **Measure Time** button. The value is returned in units of Hz.

MEAS

Read Pin State **A****Meas: Read Pin State**

Measurement block that uses the internal voltage comparator to compute the state of the pin selected by **Read Pin** button. This button is used in conjunction with the **Pin Mode**: 'continuity' button setting.

**PANEL: PATTERNS****Seq Pattern**

A drop down list button used to specify a pattern name that will be emitted by the designated communication pins. It is commonly used with the **Pattern Fail** measurement block. The **Seq Pattern** button is only valid in a pre/post measure group. In the pre/post measure group it is followed with a **Seq Repeat** button to execute.

Seq Pattern

none

**Pattern Mode**

A drop down list button that controls the pattern emit engine. It is placed in a pre/post measure or measure sequence button grouping with the **Seq Pattern** and **Seq Repeat** buttons with a **Pattern Fail** or **Read Special** measurement block.

'idle' is the default off state of the pattern emit engine.

'begin' initiates the pattern emit engine to load the pattern specified by the **Seq Pattern** button. In a measure sequence it is typically

Pattern Mode

idle

placed at the beginning of the sequence and followed by a **Sequence Delay** and **Pattern Mode**: 'run' button.

'beginStep' initiates the pattern emit engine in an inner/outer loop grouping. When the outer loop value is equal to 1, the pattern is loaded and on increments of the loop, the pattern is emitted.

'run' starts the pattern emit in a measure sequence.

'nextStep' restarts the pattern in a measure sequence.

'stop' forces a hard stop of the pattern emit in a measure sequence or post measure group.

**Seq Repeat**

An integer data entry button to specify the number of times to repeat a prior pattern. A value of 0 repeats indefinitely.

Seq Repeat

1

**Meas: Read Special**

Measurement block that uses a 4-bit capture buffer on Dpins 16, 17, 18, and 19, using Dpins 20 as a clock input from the device. The returned value is a vector vs. time result with the size of the capture set by **Read Size** button.

MEAS

Read Special A



*NOTE: the Clock Mode: 'd20' button setting must be used.*



## Meas: Pattern Fail

Measurement block that returns bit location of the first pattern failure. The block returns 0 if there are no pattern failures.

*NOTE: The first bit location is designated as location 1.*

## PANEL: SERIAL DATA

Serial Idle



## Serial Idle

Text string input button that sets the idle state for the designated clock, strobe, data and aux pins. The input text capitalization determines the voltage state of the pins before and after a communication protocol is executed. The input value 'CDSa', represents an idle 'high' voltage value set by the **Vhigh** button for clock, data, and strobe with an idle 'low' voltage value set by the **Vlow** button for the aux pin. This button is commonly used with the **D1-1** through **D1-20**, **Serial Data**, **Read Pin**, **Read Size**, **Vector Period**, and **Clock Mode** buttons for serial communication.

*NOTE: The idle state of the pins must be defined by the Serial Idle button for serial communication emits to be executed.*

**Serial Data****Serial Data**

Text string input button that generates a serial emit pattern for the serial data output. Data is input as **protocol:packet size:write data:read mask**.

*NOTE: The Serial Data button must be used in a Premeasure or Measure Sequence group.*

The **protocol** values supported are: 'jtag', 'i2c', and 'spi'.

The **packet size** value is a number representing the number of bits and associated clock cycles in the packet emit.

The **write data** value is the data to be emitted to the device under test in binary form. The value is input as hexadecimal values for the I<sup>2</sup>C protocol.

The **read mask** text value is an optional entry that defines mask bits to be logical AND'd with the bits captured on the read pin from the device under test. A value of '1' retains the associated bit, '0' or 'X' represent 'don't care' values in the bit stream. For example '1111XXXX' would capture the first four bits and discard the last four bits in a capture. The value is input as hexadecimal values for I<sup>2</sup>C protocol.

*NOTE: The read mask can be expressed in short-form notation with a number followed by an 'X', '0', or '1' to represent the number of characters in the mask positions, i.e. - the read mask input value '1111XXXX' can be expressed as '41 4X' and the read mask input value 'XXXX 0000 1111 1111' can be expressed as '4X 40 81'.*

Example Serial Data button inputs:

**Serial Data**


SPI protocol with 16 clock edges that is emitting the hexadecimal byte CF00 and reading back 16 bits; The first 8 values are ignored, representing the read data as an 8-bit decimal value between 0-255.

**Serial Data**


JTAG protocol with 16 clock edges that is emitting the hexadecimal byte 00FF and ignoring any read bits.

**Serial Data**


I<sup>2</sup>C protocol emit with 8 data clock edges and 1 ACK bit that is emitting the hexadecimal byte CF (1100 1111) and ignoring any read bits.

*NOTE: Whitespace characters (space bar) are ignored in the Serial Data button and can be used to separate and view binary data chains as bytes.*

This button is commonly used with the **D1-1** through **D1-20**, **Serial Idle**, **Serial Type**:‘manual’, **Read Pin**, **Read Size**, **Vector Period**, and **Clock Mode** buttons as well as the **Serial Read** measurement block.

Serial Type

manual

## Serial Type

Drop down list button that defines the communication control mode for the read data, data, clock, and strobe pins set by the **D1-1** through **D1-20** button settings. The selection type inherits and enforces timing behavior specified by the *protocol* in the **Serial Data** button or [Device Control Definition](#).

The ‘manual’ selection provides communication control via the **Serial Data** button. This button is commonly used with the **D1-1** through **D1-20**, **Serial Idle**, **Serial Type**:‘manual’, **Read Pin**, **Read Size**, **Read Pin**, **Vector Period**, and **Clock Mode** buttons as well as the **Serial Read** measurement block.

The ‘DUT Defined’ selection uses the communication parameters defined in the [Device Control Editor](#) under the **Formats** tab to enable protocol-aware communication with a DUT. It is typically used with

devices that contain multiple registers with programmable functions. This button selection will override the settings for any **Clock Polarity**, **Serial Direction**, **Strobe Length**, and **Strobe Polarity** buttons in the test plan. See the [Device Control Definition](#) and [DUT Instrument](#) section for more information.

---

*CAUTION: The Serial Type button of the StaticDigital instrument in the RI8546 Device Power TIM defaults to the value of ‘Dut Defined.’ If the Dpins instrument is the target communication instrument, all Static Digital Serial Type buttons must be placed in the Global Defaults of a test plan and set to ‘none.’*

---

Serial Group

none

## Serial Group

A drop down list button that selects a pin group to define the clock, data, read, and or strobe pins. Pin groups are defined in the **Device Pins** tab of the [Device Connection Editor](#). A ‘DUT’ (Device definition with associated Device Pins definition) must be active in the system configuration to access the **Serial Group** button options. Reference the [Dut Instrument](#) section for information on how to add a device to the system configuration.

## Read Polarity

Drop down list button that sets the polarity of the bit values on the read pin designated by the **Read Pin** button.

‘normal’ is the default mode and does not alter the bit polarity of the bits from the device under test.

‘inverted’ reverses the bit polarity of the captured bits on the read line from the device under test.

Read Polarity

normal

## Read Pin

A drop down list button that selects internal measurement resources to connect to the designated pin. The measurement resource used is dependent on additional buttons and/or measurement blocks included in the testplan, with commonly used **Read Pin** setups listed as follows:

Frequency counter resource includes the **Pin Mode**: ‘normal’ and **Measure Time** buttons with **Pin Frequency** measurement block.

The voltage comparator resource includes the **Pin Mode**: ‘continuity’ button and **Read Pin State** measurement block.

Read Pin

none

The internal read buffer resource used for synchronous communication protocols includes the **Pin Mode**: ‘normal’, **Read Size**, **Read Polarity**, and **Read Delay** buttons with the **Read Serial** measurement block.

## Read Delay

Drop down list button that offsets the read signal from the clock to adjust bit read timing alignment. The input values are in units of number of clock periods with valid input values of: -1, 0, 1, or 2. This button is commonly used with the **D1-1** through **D1-20**, **Read Pin**, **Read Size**, **Read Pin**, **Vector Period**, and **Clock Mode** buttons as well as the **Serial Read** measurement block.

Read Delay

0

## Read Size

Integer data button that sets the number of bits to capture. The maximum value is 1000 samples. When used with the **Serial Read** measurement block, the **Read Size** sets the decimal expression range, i.e - a **Read Size** value of ‘12’ would give answers in the decimal range from 0-4095.

Read Size

0

When used with the **Logic Analysis** measurement block, the capture size is the **Read Size** value multiplied by the over sample rate set by **Logic Analyzer Mode** value.

*NOTE: The Read Size can be dynamically set within a measure sequence group to adjust the capture parameters for multiple measurements, i.e. - the Read Size button value can be set to '8' for a Serial Read measurement to provide a decimal range from 0-255 and then set to 100 to capture a larger capture range for the Logic Analysis measurement block within a single measure sequence group.*

## Read Mode

Drop down list button that defines bit capture actions. Multiple Read Mode buttons are typically used in conjunction with **Sequence Delay** buttons (in the **System > state** selection of the Edit Panel) to define the capture window duration.

'stop' terminates the read capture. It is typically placed last in a measure sequence or in a post measure grouping.

'start' initiates the read capture. It is typically placed before a **Serial Data** button or other DUT instrument emit command in a measure sequence or pre measure grouping to modify the data capture.

Read Mode

stop

'pause' halts the read capture. It is used in conjunction with a **Sequence Delay** button and the **Read Mode**: 'resume' and/or 'stop' setting in a measure sequence or pre measure grouping.

'resume' continues a previously paused read capture. It is used in a measure sequence or pre measure grouping after a **Read Mode**: 'pause' setting typically in conjunction with a **Sequence Delay** button to modify the data capture.

*NOTE: Read Mode buttons are only valid in premeasure or measure sequence groups.*

## Serial Lv Write

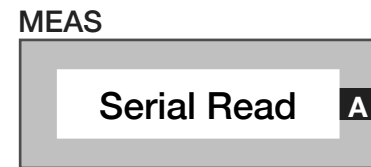
Input button used as the target of a local variable write. It uses the **Serial Data** packet size and read mask to set the value range size.

*NOTE: This button is only valid in premeasure or postmeasure button groups.*

Serial Lv Write

0.0





## Meas: Serial Read

Measurement block that captures and returns the contents of the serial read buffer designated by the **Read Pin** and **Read Size** buttons and returns the decimal value of the bits. See the [A shift B and C calculation block](#) for extracting individual bits or bit strings within a serial read capture.

## PANEL: SERIAL SCAN

Read Polarity

normal

### Read Polarity

Drop down list button that sets the polarity for the read pin designated by the **Read Pin** button.

‘normal’ is the default mode and maintains the logic polarity of the captured bits read from the device under test.

‘inverted’ reverses the logic polarity of the captured bits from the device under test.

Read Pin

none

### Read Pin

A drop down list button that selects internal measurement resources to connect to the designated pin. The measurement resource used is dependent on additional buttons and/or measurement blocks included in the testplan, with commonly used **Read Pin** setups listed as follows:

Frequency counter resource includes the **Pin Mode**: ‘normal’ and **Measure Time** buttons with **Pin Frequency** measurement block.

The voltage comparator resource includes the **Pin Mode**: ‘continuity’ button and **Read Pin State** measurement block.

The internal read buffer resource used for synchronous communication protocols includes the **Pin Mode**: ‘normal’, **Read Size**, **Read Polarity**, and **Read Delay** buttons with the **Read Serial** measurement block.

Read Delay

## Read Delay

Drop down list button that offsets the read signal from the clock to adjust bit read timing alignment. The input values are in units of number of clock periods with valid input values of: -1, 0, 1, or 2. This button is commonly used with the **D1-1** through **D1-20**, **Read Pin**, **Read Size**, **Read Pin**, **Vector Period**, and **Clock Mode** buttons as well as the **Serial Read** measurement block.

Seq Pattern

## Seq Pattern

Drop down list button of scan pattern/s loaded into the Dpins instrument that will be emitted. It is only valid in pre measure or measure sequence groups and is used in conjunction with a **Seq**

**Repeat** and or **Pattern Mode** buttons to execute the emit of the designated pattern.

Seq Repeat

## Seq Repeat

An integer value button that sets the number of repeats of a designated pattern from the **Seq Pattern** button. It is only valid in pre measure or measure sequence groups and is used in conjunction with the **Pattern Mode** button.

*NOTE: Scan patterns are limited to the default value of 1.*

Pattern Mode

## Pattern Mode

A drop down list button that controls the pattern emit engine. It is placed in a pre/post measure or measure sequence button grouping with the **Seq Pattern** and **Seq Repeat** buttons with a **Pattern Fail** or **Read Special** measurement block.

‘idle’ is the default off state of the pattern emit engine.

'begin' initializes the pattern engine to load the pattern designated by the Seq Pattern button into the emit buffer.

'beginStep' initiates a pattern emit in an inner/outer loop grouping only. When the outer loop value is equal to 1, the pattern is loaded and on increments of the loop, the pattern is emitted.

'run' starts the pattern emit.

'nextStep' restarts the pattern.

'stop' forces a hard stop of the pattern emit.

Serial Group

none

## Serial Group

A drop down list button that selects a pin group used for continuity measurements. Pin groups are defined in the Device Pins tab of the Device Connection Editor. The associated device must be active in the system configuration to be accessible to the **Serial Group** button options. Reference the [Dut Instrument](#) section for information on how to add a device to the system configuration.

MEAS



## Meas: Pattern Fail

Measurement block that returns an integer value indicating the bit location of the first pattern failure. The block returns 0 if there are no pattern failures.

*NOTE: The first bit location is designated as location 1.*

**PANEL: LOGIC ANALYZER**

Logic Analyzer Trigger

off

**Logic Analyzer Trigger**

Drop down list button that controls the analyzer's capture trigger timing when using the **Logic Analysis** measurement block. This button is only valid in a pre/post measure and measure sequence groups and is commonly used with the **Logic Analyzer Signal**, **Logic Analyzer Trigger**, and **Logic Analyzer Capture** buttons.

'off' is the default state and disables the trigger.

'enable' sets the trigger to begin/end when a **Read Mode**: 'start' button is encountered in the pre measure or measure sequence group.

'immediate' initiates the trigger in a pre measure or measure sequence group where the **Logic Analyzer Trigger**: 'immediate' button is encountered in the sequence.

Logic Analyzer Capture

current

**Logic Analyzer Capture**

Drop down list button that selects the pins that will be connected to the analyzer instrument during data capture using the **Logic Analysis** measurement block. It is placed in the Global or Section Defaults of a test plan and is commonly used with the **Logic Analyzer Signal**, **Logic Analyzer Trigger**, and **Logic Analyzer Mode** buttons.

'Current' selects all pins designated in the **Seq Pattern** button pattern emit.

'All' selects all 20 pins.

'Serial' selects the pins designated by the **Serial Group** button.

'Other' selects the pins designated by the **Pin Group** button.

Logic Analyzer Signals

wide

**Logic Analyzer Signals**

Drop down list button that captures and displays additional internal signals in the logic analyzer plot when using the **Logic Analysis** measurement block. It is placed in the Global or Section Defaults of a test plan and is commonly used with the **Logic Analyzer Mode**, **Logic Analyzer Trigger**, and **Logic Analyzer Capture** buttons.

'wide' displays additional internal capture/timing/trigger signals of the logic analyzer on y-axis: 21 through 24 of the plot view.

See [Example C](#).

'narrow' limits the logic analyzer to only display the 20 *Dpins* in the analyzer plot viewer.

Logic Analyzer Mode

X4

## Logic Analyzer Mode

Drop down list button that selects the oversample rate of the logic analyzer relative to the clock period set by the **Vector Period** button when capturing signals with the **Logic Analysis** measurement block. It is placed in the Global or Section Defaults of a test plan and is commonly used with the **Logic Analyzer Signal**, **Logic Analyzer Trigger**, and **Logic Analyzer Capture** buttons.

'X4' is the default setting and sets the capture rate to four samples per clock period

'X2' sets the capture rate to two samples per clock period.

'X1' sets the capture rate to one sample per clock period.

Read Size

0

## Read Size

Integer data button that sets the number of samples to capture in a bit stream. The maximum input value is 1000 samples.

When used with the **Serial Read** measurement block, the **Read Size** sets the decimal expression range, i.e. - a **Read Size** value of '12' would give answers in the decimal range of 0-4095.

When used with the **Logic Analysis** measurement block, the capture size is the **Read Size** value multiplied by the over sample rate set by **Logic Analyzer Mode** value.

*NOTE: The Read Size can be dynamically set within a measure sequence group to adjust the capture parameters for multiple measurements, i.e. - the Read Size button value can be set to '8' for a Serial Read measurement to provide a decimal range from 0-255 and then set to 100 to capture a large emit range for the Logic Analysis measurement block within a single measure sequence group.*

Logic Analyzer Trigger Mode

off

## Logic Analyzer Trigger Mode

Drop down list button that selects an event to trigger the logic analyzer signal capture of the **Logic Analysis** measurement block. It is placed in the Global or Section Defaults of a test plan and is



commonly used with the **Logic Analyzer Signal**, **Logic Analyzer Trigger**, **Logic Analyzer Capture**, and **Logic Analyzer Mode** buttons.

‘off’ deactivates the trigger and no data is captured.

‘external’ is for RI internal purposes only.

‘onFail’ triggers the logic analyzer capture to start immediately following a measured fail bit in a pattern designated by the **Seq Pattern** button.

‘onRead’ triggers the logic analyzer capture to start when the **Read Mode**: ‘start’ is encountered, subject to the offset imposed by the **Read Delay** setting.

‘atVector’ triggers the logic analyzer capture to start the capture in accordance with the **Location Mode** setting, subject to the offset imposed by the **Trigger Vector** button value.

‘patternStart’ captures all bits in the pattern specified by the **Seq Pattern** button.

‘serial’ triggers the captures bits after **Serial Data** button or [DUT instrument](#) protocol buttons.

Trigger Vector

0

## Trigger Vector

Integer value button that offsets the starting point of a trigger event by the specified number of bits or clock edges defined by the **Location Mode** and **Logic Analyzer Trigger Mode** buttons.

Location Mode

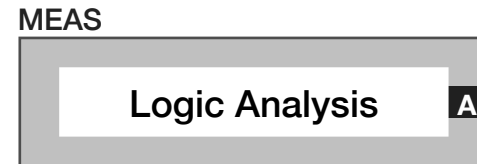
dutClocks

## Location Mode

Drop down list button that selects the method for counting pattern vectors when using the **Trigger Vector** button to start or offset the start of a logic analyzer capture. This button is used in conjunction with the **Logic Analyzer Trigger Mode** button to designate the target vector type.

‘dutClocks’ sets the clock pin designated by a **D1-1** to **D1-20**: ‘clock’ or ‘/clock’ button setting as the vector target with the **Logic Analyzer Trigger Mode**: ‘serial’ or ‘onRead’ button setting and **Trigger Vector** offset value.

‘vector’ sets the pattern designated by a **D1-1** to **D1-20**: ‘clock’ or ‘/clock’ buttons as the signal vector target with the **Logic Analyzer Trigger Mode**: ‘atVector’ button setting and **Trigger Vector** offset value.

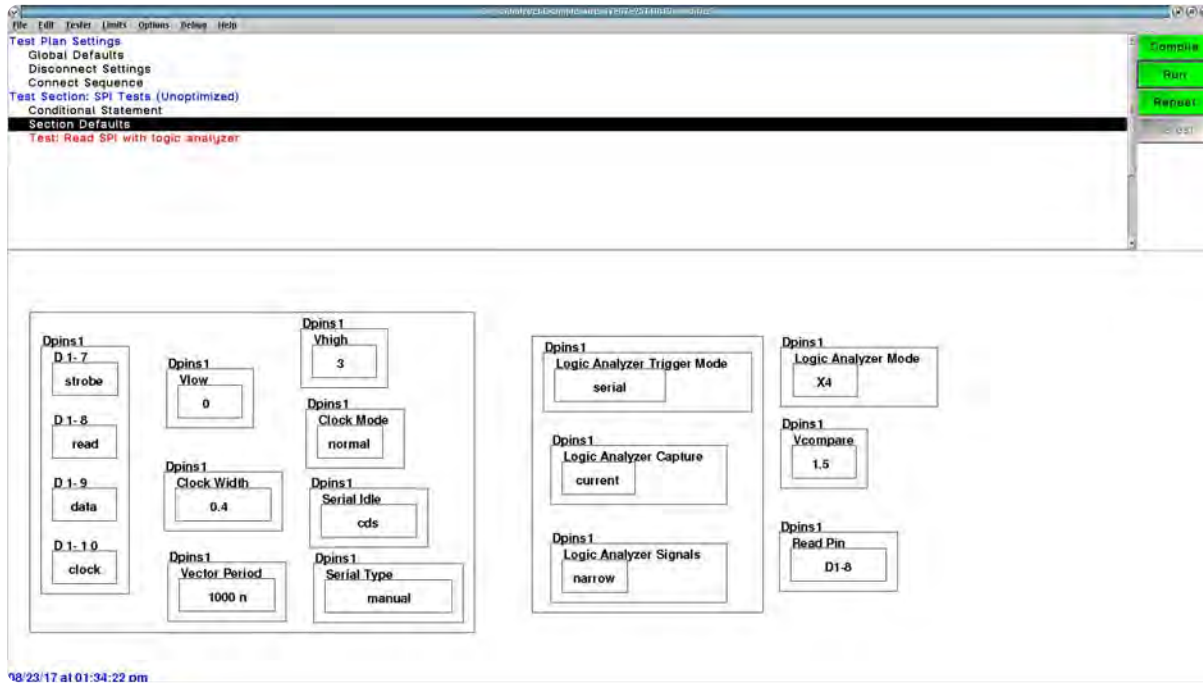


## Meas: Logic Analysis

The Logic Analysis measurement block captures the bit stream of pins specified by the **Logic Analyzer Capture** button and displays them in a plot window of a **Local Variable** save. This button is used in conjunction with the **Read Size**, **Read Mode**, **Logic Analyzer Signal**, **Logic Analyzer Trigger**, **Logic Analyzer Capture**, and **Logic Analyzer Mode** buttons. See [Example B](#).

*NOTE: The output of the Logic Analysis measurement block must be connected to a Local Variable save. The analyzer plot can be viewed by compiling the test program, left clicking on the Local Variable save block and selecting the Rectangular plot viewer with the Sort By Format set to 'index' and the x parameter set to 'time'. Each Dpin is displayed on the y-axis value that corresponds to the pin number, i.e - the y-axis value of 10 represents Dpins1 bit 10 or D1-10. See [Example C](#).*

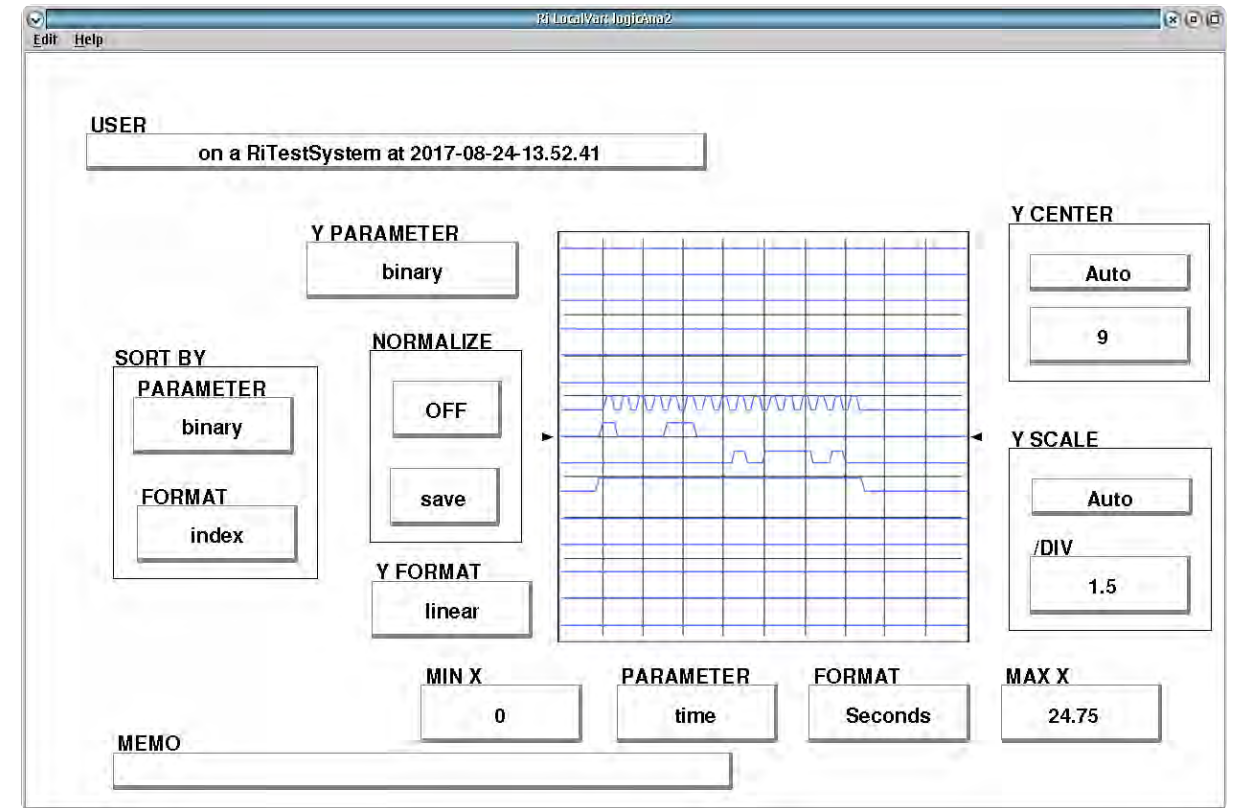
### EXAMPLE B LOGIC ANALYZER SETUP



The above shows the setup for serial SPI communication (buttons on the left of the panel) and the logic analyzer display and capture setup (buttons on the right of the panel)

• •

### EXAMPLE C LOGIC ANALYZER VIEWER

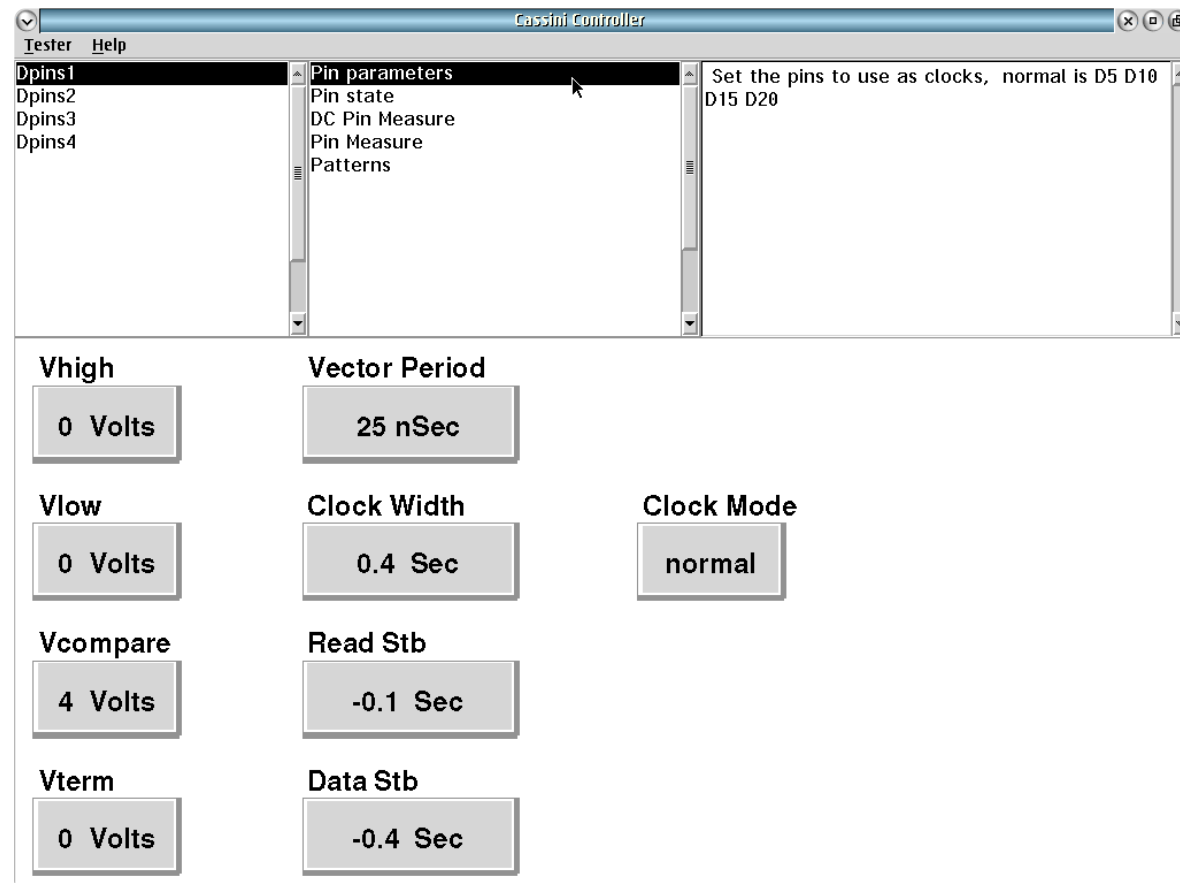


The plot viewer shows the resulting clock, data, read and strobe bit streams in a logic analyzer capture. The plot is centered on Dpin 9 (data write) with Dpin 10 (clock) above, Dpin 8 (read) and Dpin 7 (strobe) below.

## CONTROL PANELS

Real-time control of the instruments in this TIM.

### CONTROL PANELS 3 RI8535 UNIVERSAL DIGITAL



Allows Dpins voltage supply control and clock controls.

## DPINS

### PIN PARAMETERS

Allows Dpins voltage supply control and clock controls.

### PIN STATE CONTROL PANEL

Enables individual pin state settings for voltage setting and communication pin designation.

### DC PIN MEASURE CONTROL PANEL

DC Pin Measure enables pin measure setup and real-time measurements for Voltage and Current.

Voltages are displayed in units of Volts and current in units of Amps in real-time.

### PIN MEASURE CONTROL PANEL

Displays frequency counter results for the selected pin and capture window adjustment. Frequency values are displayed in Hz in real-time.



## ***PATTERNS CONTROL PANEL***

---

Provides digital communication setup and emit control buttons for manual pattern emits and bit read capability.



# RI8545: 0.1 TO 20 GHz TESTSET



## TOPICS

---

[Instruments Provided by this TIM](#)

[Instrument Diagram with Edit Buttons](#)

[Edit Panel Button Descriptions](#)

[Control Panel](#)

Tap the links above to quickly access content.

## INSTRUMENTS PROVIDED BY THIS TIM

The instrument in this TIM appear as **Test Head** in the panel dialog windows.

Model and Name as it appears in the Tester Configuration:

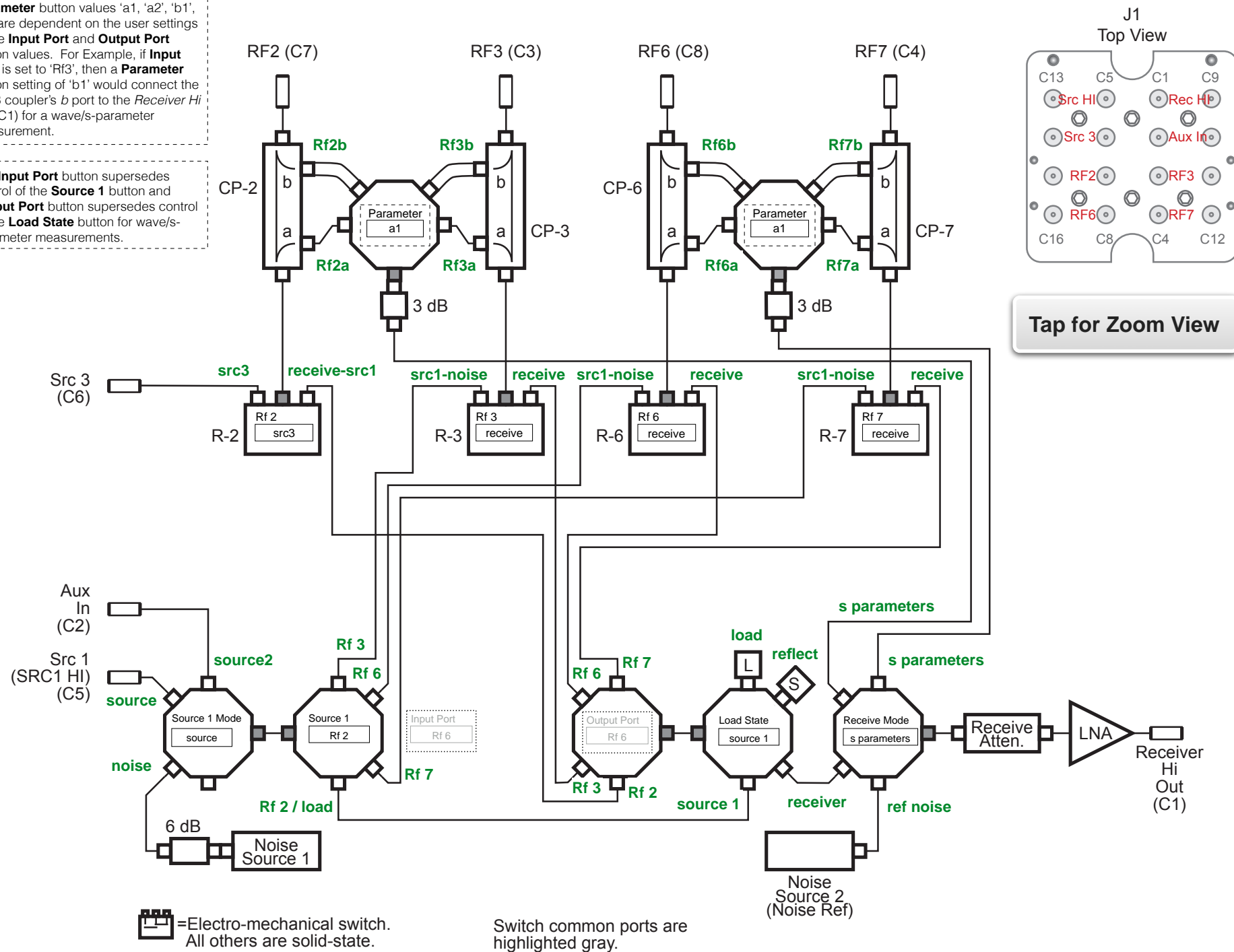
- Test Head, RI8545x 4 port Testset

*NOTE: Multiple RI8545 instruments are enumerated incrementally by the system as “2”, “3”, etc. in the configuration, edit, and control panels (i.e - Test Head, Test Head2, Test Head3, etc). The “x” in RI8564x denotes the model revision number.*

### INSTRUMENT BUTTON DIAGRAM 2.3

Parameter button values 'a1', 'a2', 'b1', 'b2' are dependent on the user settings of the **Input Port** and **Output Port** button values. For Example, if **Input Port** is set to 'Rf3', then a **Parameter** button setting of 'b1' would connect the CP-3 coupler's *b* port to the *Receiver Hi Out*(C1) for a wave/s-parameter measurement.

The **Input Port** button supersedes control of the **Source 1** button and **Output Port** button supersedes control of the **Load State** button for wave/s-parameter measurements.

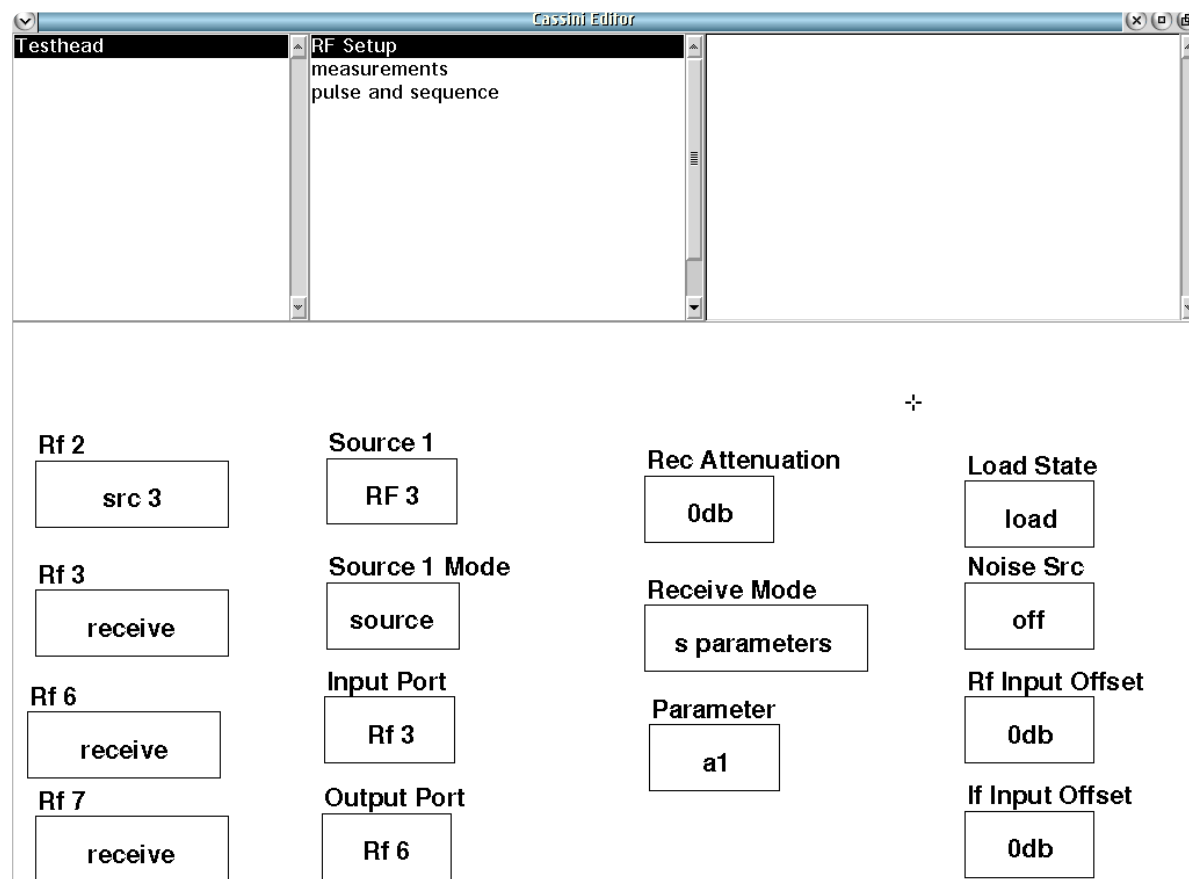


Button modes are shown in green text next to their associated function or signal path designation.

## EDIT PANELS

Automated control of the instruments in this TIM with use by the Test Plan Editor.

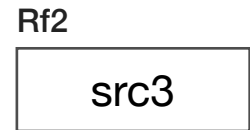
### EDIT PANELS 5 RI8545 4 PORT TESTSET



RF Setup controls instrument resource routing.



## PANEL: RF SETUP



### Rf 2

Drop down list button that controls the resource connections to the *RF2 (C7)* coupled input/output port. The button configures the mechanical relay *R-2* to connect RF2 to various internal resources or input/output ports.

This button in combination with the **Source 1**, **Source 1 Mode**, **Receive Mode**, and **Load State** buttons set the signal path routing through the TIM's internal mechanical relay connections.

'src3' selection connects *RF2 (C7)* as an output port driven by the resource connected to *Src 3 (C6)*.

'receive-src1' connects *RF2 (C7)* to the internal set of solid state switches: M26-B (controlled by **Output Port**), M11-B (controlled by **Load State**, M14-B (controlled by **Receive Mode**), M26-T (controlled by **Input Port**, and M11-T (controlled by **Source 1 Mode**). This selection is used to connect *RF2 (C7)* to the *Receiver Hi Out (C1)*, the internal RF 50Ω load or short termination, *Src 1 (C5)*, *Aux In (C2)* or *Noise Source 1*.

Rf3

receive

**Rf 3**

Drop down list button that controls the resource connections to the *RF3* (C3) coupled input/output port. The button configures the mechanical relay *R-3* to connect *RF3* to various internal resources or input/output ports.

‘src1-noise’ connects *RF3* (C3) to the internal set of solid state switches: M26-T (controlled by **Input Port**), M11-T (controlled by **Source 1 Mode**). This selection is used to connect *RF3* (C7) to *Src 1* (C5), *Aux In* (C2) or *Noise Source 1*.

‘receive’ connects the input port to the internal set of solid state switches: M26-B (controlled by **Output Port**), M11-B (controlled by **Load State**, M14-B (controlled by **Receive Mode**). This mode is typically used to connect *RF3* (C3) to *Receiver Hi Out* (C1) for receiver type measurements: **Output Port**: ‘Rf 3’, **Load State**: ‘receiver’, **Receive Mode**: ‘receiver’.

*NOTE: The ‘receive’ mode can also access Src 1 (C5) for s-parameter measurements. This “back-door” mode is useful for reducing wear of electro-mechanical switches R-3, R-6, and R-7, helping to extend their lifecycle and reducing settling times in measurements. Reference [Gallery 2](#) for example and suggested setups.*

Rf6

receive

**Rf 6**

Drop down list button that controls the resource connections to the *RF6* (C8) coupled input/output port. The button configures the mechanical relay *R-6* to connect *RF6* to various internal resources or input/output ports.

‘src1-noise’ connects *RF6* (C8) to the internal set of solid state switches: M26-T (controlled by **Input Port**), M11-T (controlled by **Source 1 Mode**). This selection is used to connect *RF6* (C8) to *Src 1* (C5), *Aux In* (C2) or *Noise Source 1*.

‘receive’ connects the input port to the internal set of solid state switches: M26-B (controlled by **Output Port**), M11-B (controlled by **Load State**, M14-B (controlled by **Receive Mode**). This mode is typically used to connect *RF6* (C8) to *Receiver Hi Out* (C1) for receiver type measurements: **Output Port**: ‘Rf 6’, **Load State**: ‘receiver’, **Receive Mode**: ‘receiver’.

*NOTE: The ‘receive’ mode can also access Src 1 (C5) for s-parameter measurements. This “back-door” mode is useful for reducing wear of electro-mechanical switches R-3, R-6, and R-7, helping to extend their lifecycle and reducing settling times in measurements. Reference [Gallery 2](#) for example and suggested setups.*



Rf7

receive

## Rf 7

Drop down list button that controls the resource connections to the *RF7* (C4) coupled input/output port. The button configures the mechanical relay *R-7* to connect *RF7* to various internal resources or input/output ports.

'src1-noise' connects *RF7* (C4) to the internal set of solid state switches: M26-T (controlled by **Input Port**), M11-T (controlled by **Source 1 Mode**). This selection is used to connect *RF6* (C8) to *Src 1* (C5), *Aux In* (C2) or *Noise Source 1*.

'receive' connects the input port to the internal set of solid state switches: M26-B (controlled by **Output Port**), M11-B (controlled by **Load State**), M14-B (controlled by **Receive Mode**). This mode is typically used to connect *RF7* (C4) to *Receiver Hi Out* (C1) for receiver type measurements: **Output Port**: 'Rf 7', **Load State**: 'receiver', **Receive Mode**: 'receiver'.

*NOTE: The 'receive' mode can also access Src 1 (C5) for s-parameter measurements. This "back-door" mode is useful for reducing wear of electro-mechanical switches R-3, R-6, and R-7, helping to extend their lifecycle and reducing settling times in measurements. Reference [Gallery 2](#) for example and suggested setups.*

Source 1

RF 3

## Source 1

Drop down list button that controls the solid state switch M26-T in the block diagram.

'Rf 2', 'Rf 3', 'Rf 6', and 'Rf 7' values provides intermediary path routing control between resources set by **Source 1 Mode**: *Src 1* (C5), *Aux In* (C2) or *Noise Source 1* and the electro-mechanical relays R-2, R-3, R-6, and R-7. In typically applications, this button is used with **Rf 2** set to 'receive-src1', and **Rf 3**, **Rf 6** or **Rf 7** buttons are set to 'src1-noise' when routing source resources to the coupled ports.

The 'load' selection provides intermediary path routing control between resources set by **Source 1 Mode**: *Src 1* (C5), *Aux In* (C2) or *Noise Source 1* and the solid-state switch M26-T that is controlled by the **Load State** button. This setting has the same function as the 'Rf 2' selection.

*NOTE: When Receiver Mode is set to 's-parameter', the Input Port button supersedes the Source 1 button for control of the M26-T switch position, thus the Source 1 button is not required in the test panels for this function.*

## Source 1 Mode

source

**Source 1 Mode**

This list select button directly controls the solid state switch *M11-T*. It is used to connect *Src 1 (C5)*, *Aux In (C2)* or *Noise Source 1* to the internal switching network and used in conjunction with the **Source 1**, **Rf 2**: 'receive-src1', and **Rf 3**: 'src1-noise', **Rf 6**: 'src1-noise' or **Rf 7**: 'src1-noise' button settings to route signals to the coupled ports *RF2 (C7)*, *RF3 (C3)*, *RF6 (C8)*, or *RF7 (C4)*

'source' connects the input port *Src 1 (C5)* to the M26-T switch to route a stimuli signal to output ports.

'noise' connects the internal noise diode *Noise Source 1* to the M26-T switch. This button setting is used in conjunction with the **Noise Src** button to activate/deactivate the noise reference standard.

'source2' mode connects the *Aux In (C2)* to the internal switching network for utilizing a second external source; to to drive RF output ports selected by the **Source 1**, **Rf 2**: 'receive-src1' or **Rf 3/Rf 6/Rf 7**: 'receive-src1' buttons.

## Input Port

Rf 3

**Input Port**

This drop down list selection button that designates which of the RF input/output ports [*RF2 (C7)*, *RF3 (C3)*, *RF6 (C8)*, or *RF7 (C4)*] will be defined as the input port to the Device Under Test for protocol-aware s/wave parameter measurements. This button activates the compiler's expert system mode to control and orchestrate the entire internal switch network for all wave parameters measurements automatically. This programming approach allows the user to avoid having to setup the switching network for each load condition and forward/incident wave measurement. The compiler also automatically computes error-corrected *s11*, *s12*, *s21*, and *s22*. The **Output Port** button, and corresponding source/receive mode settings for **Rf 2**, **Rf 3**, **Rf 6** and/or **Rf 7** buttons are used with the **Input Port** button.

*NOTE: The 'Rf 4' selection is a Small Cassini mode that is not supported in Cassini 16.*

## Output Port

Rf 6

**Output Port**

This drop down list selection button that designates which of the input/output ports [*RF2 (C7)*, *RF3 (C3)*, *RF6 (C8)*, or *RF7 (C4)*] will be defined as the output port from the Device Under Test for protocol-

aware s/wave parameter measurements. This button activates the compiler's expert system mode to control and orchestrate the entire internal switch network for all wave parameters measurements automatically. This programming approach allows the user to avoid having to setup the switching network for each load condition and forward/incident wave measurement. The compiler also automatically computes error-corrected s11, s12, s21, and s22. The **Input Port** button, and corresponding source/receive mode settings for **Rf 2**, **Rf 3**, **Rf 6** and/or **Rf 7** buttons are used with the **Output Port** button.

*NOTE: The 'Rf 5' selection is a Small Cassini mode that is not supported in Cassini 16.*

## Rec Attenuation

This drop down list selection button configures the receive attenuator found at the common port output of the M14-B switch. The solid-state attenuator has calibrated attenuation steps of 0 dB, 10 dB, 20 dB, or 30 dB. This button is commonly used in s-parameter and power measurement receive measurements to prevent overdriving/saturating the downstream receiver's RF front-end or optimizing the RF input signal power for best dynamic range with the receiver.

Rec Attenuation

0db

Receive Mode

s-parameters

## Receive Mode

This drop down list selection button selects which resource is routed to the output port *Receiver Hi Out (C1)* by directly setting the solid state switch position of *M14-B*.

's-parameters' connects *Receiver Hi Out (C1)* to the coupled ports pairs *RF2/RF3 (M14-B: Position 3)* or *RF6/RF7 (M14-B: Position 4)* depending on the settings of the **Input Port**, **Output Port** and the **Parameter** buttons. For example, setting **Output Port** to 'RF2', **Input Port** to 'RF3' and **Parameter** to 'a1' would route the incident signal on the CP-2 coupler's 'a' port to *Receiver Hi Out (C1)*.

'ref noise' connects the *Receiver Hi Out (C1)* output port to the internal noise reference standard (*M14-B: Position 2*).

*NOTE: This noise reference is used as a stable power reference strictly for the instrument's internal self-check.*

'receiver' connects the the *Receiver Hi Out (C1)* output port as a direct receive path (*M14-B: Position 1*) typically for *RF2 (C7)*, *RF3 (C3)*, *RF6 (C8)*, or *RF7 (C4)*. Resource routing to the direct receive path is dependent on the **Load State** button (controls *M11-B*), **Input Port** button (controls *M26-T*), and by setting the **Rf 2/Rf 3**, **Rf 6** or **Rf 7** button to their receive mode setting.

Parameter

a1

## Parameter

Drop down list button that designates which of the coupler ports [CP-2 (RF2), CP-3 (RF3), CP-6 (RF6), CP-7 (RF7)] will be routed to the switching network. It is typically used for routing incident/reflected wave signals to the receiver for wave/s-parameter measurements.

The 'a1', 'b1', 'a2', and 'b2' selections uses the compiler's expert system to automatically select the correct switch routing. These selections require an RF port to be set by **Input Port** and **Output Port** buttons and corresponding **Rf 2/Rf 3**, **Rf 6** or **Rf 7** button selections.

The 'rf2a', 'rf2b', 'rf3a', 'rf3b', 'rf6a', 'rf6b', 'rf7a', or 'rf7b' selections allow the user to explicitly control the port selection of switches *B Top* and *D Bottom* shown at the top of the block diagram.

### NOTE:

*a1 is the incident wave to the input port of the device under test.  
b1 is the reflected wave from the input port of the device under test.  
a2 is the incident wave to the output port of the device under test.  
b2 is the reflected wave from the output port of the device under test.*

Load State

load

## Load State

Drop down list button that directly controls the solid state switch *M11-B*.

The 'source1' selection is used to connect *Src 1 (C5)*, *Aux In (C2)* or *Noise Source 1* to *M11-B* for routing these resources to *RF2 (C7)*, *RF3 (C3)*, *RF6 (C8)*, or *RF7 (C4)* using the "back-door" switching route. The buttons **Source 1**: 'Rf 2' or 'load' | **Source 1 Mode**: 'source', 'source2', or 'noise' | **Rf 2**: 'receive-src1', and **Rf 3**: 'src1-noise', **Rf 6**: 'src1-noise' or **Rf 7**: 'src1-noise' are used with this **Load State** selection.

*NOTE: The "backdoor" signal routing technique exploits the switching topology of the solid-state switches to reduce settling times in measurements and wear of electromechanical switches R-3, R-6, and R-7, helping to extend their lifecycle. Reference [Gallery 2](#) for example and suggested configurations.*

"reflect" is used to connect a 50Ω "short" standard to *RF2 (C7)*, *RF3 (C3)*, *RF6 (C8)*, or *RF7 (C4)*. This provides a controlled RF reflection condition for unidirectional s-parameter measurements. This button selection commonly uses the **Spar Mode**: 'unidirectional', **Input Port**, **Output Port** buttons and corresponding **Rf 2/Rf 3**, **Rf 6** or **Rf 7** buttons.

“load” is used to connect a 50Ω standard load to *RF2 (C7)*, *RF3 (C3)*, *RF6 (C8)*, or *RF7 (C4)*. This provides a controlled RF matching condition for s-parameter measurements. This button selection commonly uses the **Spar Mode**, **Input Port**, **Output Port** buttons and corresponding **Rf 2/Rf 3**, **Rf 6** or **Rf 7** buttons.

‘receive’ is used to connect the intermediary signal route from *RF2 (C7)*, *RF3 (C3)*, *RF6 (C8)*, or *RF7 (C4)* to the *Receiver Hi Out (C1)* output port for receiver type measurements. This button selection commonly uses the **Receive Mode**: ‘receiver’, **Rf 2**: ‘receive-src1’, **Rf 3**: ‘receive’, **Rf 6**: ‘receive’, or **Rf 7**: ‘receive’ button settings in test panels.

Noise Src

off

## Noise Src

Drop down list button that controls the state of the internal noise source standard *Noise Source 1*.

The ‘On’ selection powers the noise source, producing an RF calibrated “Hot” noise power.

The ‘Off’ selection deactivates power from the noise diode. This mode can be used for so called “cold” noise power measurements.

*NOTE: The calibration factors for Noise Source 1 are frequency dependent and are selected by the compiler based on the Frequency button definition found in the System instrument of the Edit Panel.*

Rf Input Offset

0db

## Rf Input Offset

This list select button directly controls the receive attenuator and *LNA* for the *Receive Hi Out (C1)* port. They are located between the last solid state switch (M14-B) and the *Receive Hi Out (C1)* port in the block diagram. The receive attenuator and LNA allow the user to optimize incoming signal power levels typically to prevent saturation of the receiver’s RF mixers. This is useful for compensating for the gain of active device, or losses from passive components for s-parameter/receiver type measurements.

The list options ‘-30’, ‘-20’, ‘-10’, ‘0’, ‘10’, ‘20’, ‘30’ are displayed in units of dB.

*NOTE: Saturation of the downstream RF mixers in the receiver TIM will cause nonlinear behavior in the form of signal harmonics at the downconverter’s output and unstable measurements.*



If Input Offset

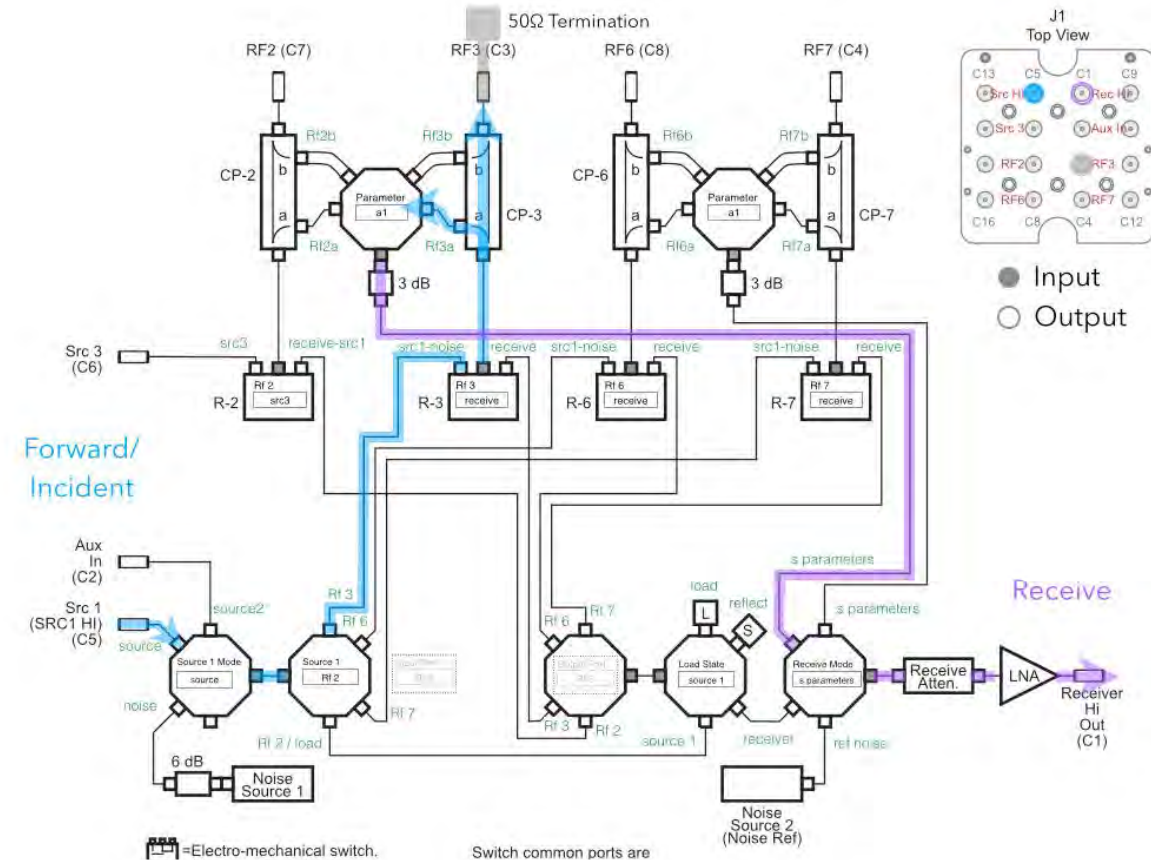
0db

### If Input Offset

This list select button is a modifier of the **If Gain** button value found in the RI8587 or RI8581 Receiver TIM. It provides relative IF gain modification, i.e **If Gain:** '38' and **If Input Offset:** '-30' would result in an actual IF Gain in the receiver of '8'. This button is typically used to offset output signals from high-gain devices or losses from passive DUTs to maintain consistent signal power into the receiver.

The list options ('-36', '-30', '-24', '-18', '-12', '-6', '0', '6', '12', '18', '24', '30' and '36') are in units of dB.

### GALLERY 2 RI8545 EXAMPLE TOPOLOGIES



### Measuring Src 1 with the Receiver (Thru Measurement)

**Example:** The signal at Src 1 (C5) is routed to the receiver. This is a common diagnostic setup used to confirm test plans route the source/receive paths as expected. The RF3 (C3) port is terminated with a standard 50Ω termination to reduce signal ripple and using a VNA type or s-parameter measurement provides the signal at Src1 (C5) via the the a<sub>1</sub> term (incident wave).

**PANEL: MEASUREMENTS**

Average Mode

std

**Average Mode**

A drop down list button that is associated with the higher-level macro measurement buttons that sets the method of averaging used.

The “std” mode uses the number of Averages set by the System Button when measuring and completes all the averages of each of the parameters in a high-level macro button before moving to the next parameter. For example, on an S<sub>11</sub> measurement with 4 averages, the tester would measure a<sub>1</sub>, a<sub>1</sub>, a<sub>1</sub>, a<sub>1</sub>, then b<sub>1</sub>, b<sub>1</sub>, b<sub>1</sub>, b<sub>1</sub>. This is the fastest averaging mode, but if the signal drifts while the a<sub>1</sub> measurements are being made, the measurement can be less accurate.

The “adjacent” mode uses the number of **Averages** set by the System Button as above, but when measuring to satisfy a high-level macro button, it takes data from each of the parameters needed one at a time, before completing another round of measurements for the average. For example, on an S<sub>11</sub> measurement with 4 averages, the tester would measure a<sub>1</sub>, b<sub>1</sub>, a<sub>1</sub>, b<sub>1</sub>, a<sub>1</sub>, b<sub>1</sub>, a<sub>1</sub>, b<sub>1</sub>. This makes the a<sub>1</sub> and b<sub>1</sub> measurements virtually simultaneous. The “adjacent averaging” mode is slightly slower than the “std” mode, but can minimize the effects of any signal drift especially for large number of averages.

*NOTE: At higher frequencies and with averages greater than 8 to 16, some improvement in accuracy and repeatability are often achieved using the adjacent averaging mode.*

Spar Mode

unidirectional

**Spar Mode**

This list select button defines the calculation mode for two-port, vector error-corrected scattering parameters. The mode selection affects the compiler’s decisions for load and source routing schemes in the TIM and the subsequent calculation methods for s/wave parameter measurements.

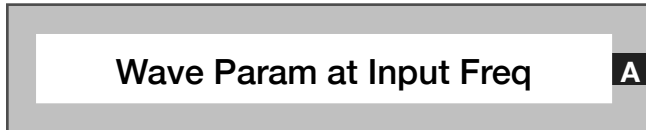
The ‘unidirectional’ mode computes s-parameters by only applying the source to the input of the DUT and using a bi-state, load pull condition on the output port to compute the a<sub>1</sub>, b<sub>1</sub>, and b<sub>2</sub> wave parameters. This mode infers the a<sub>2</sub> wave parameter and thus S<sub>22</sub>, and is faster than the bidirectional mode. Unidirectional mode is optimal for unilateral active devices (essentially zero reverse transmission coefficient, i.e. S<sub>12</sub>=0) such as power amplifiers.

The ‘bidirectional’ mode computes s-parameters using the traditional switched source methodology for measuring all eight transmission parameters and then computing scattering parameters. This selection executes all four source/load conditions on the DUT, providing the most accurate s/wave parameters possible. The bidirectional mode is optimal for passive, low-gain, or low-loss devices.

This button is commonly used with the **Input Port**, **Output Port**, **Parameter**, **Receive Mode**: 's-parameter' and corresponding **Rf 2**, **Rf 3**, **Rf 6** or **Rf 7** button designations.

### Meas: Wave Param at Input Freq

MEAS

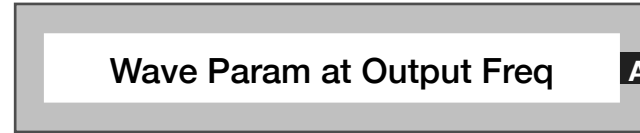


Measurement block performs a two-port, error-corrected wave parameter measurement resulting in all 8 transmission parameters:  $a_{11}$ ,  $a_{12}$ ,  $a_{21}$ ,  $a_{22}$ ,  $b_{11}$ ,  $b_{12}$ ,  $b_{21}$ ,  $b_{22}$  for a given device input frequency. It uses the bi-state load pull method with the result in absolute voltage. The receiver's tuned frequency for this button is defined by the **Freq Reference**, **Input Freq Offset**, and/or **Input Freq Scale** buttons found in the System instrument panel. This block is typically used for user-custom s/wave parameter-like calculations.

*NOTE: The frequency control button set is typically used for measuring frequency converting devices.*

### Meas: Wave Param at Output Freq

MEAS

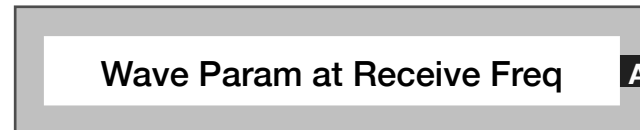


Measurement block performs a two-port, error-corrected wave parameter measurement resulting in all 8 transmission parameters:  $a_{11}$ ,  $a_{12}$ ,  $a_{21}$ ,  $a_{22}$ ,  $b_{11}$ ,  $b_{12}$ ,  $b_{21}$ ,  $b_{22}$  for a given device output frequency. It uses the bi-state load pull method with the result in absolute voltage. The receiver's tuned frequency for this button is defined by the **Freq Reference**, **Output Freq Offset**, and/or **Out Freq Scale** buttons found in the System instrument panel. This block is typically used for user-custom s/wave parameter-like calculations.

*NOTE: The frequency control button set is typically used for measuring frequency converting devices.*

### Meas: Wave Param at Receive Freq

MEAS



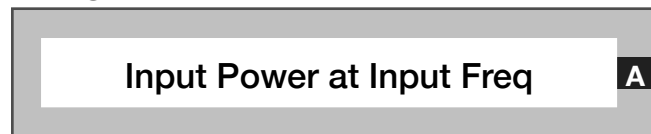
Measurement block performs a two-port, error-corrected wave parameter measurement resulting in all 8 transmission parameters:  $a_{11}$ ,  $a_{12}$ ,  $a_{21}$ ,  $a_{22}$ ,  $b_{11}$ ,  $b_{12}$ ,  $b_{21}$ ,  $b_{22}$  for a given frequency. It uses the bi-state load pull method with the result in absolute voltage. The

receiver's tuned frequency for this button is defined by the **Frequency**, and/or **Freq Offset** buttons found in the Receiver's instrument panel. This block is typically used for user-custom s/wave parameter-like calculations.

*NOTE: The phase is only defined within a set and not with any other readings.*

### Meas: InputPower at Input Freq

MEAS



Measurement block performs an error-corrected  $a_{11}$  (forward or incident wave at input with output terminated) measurement with the receiver set to measure at the frequency defined by the Freq Reference, Input Freq Offset, and/or Input Freq Scale buttons found in the System instrument panel. The resulting data is corrected absolute power, with default units of Watts

*NOTE: Units can be changed to dBm using the Convert button found in System > General Calculation panel.*

### Meas: Thru Measurement at Input Freq

MEAS



Performs an error-corrected  $a_{11}$  (forward or incident wave at input with output terminated) and  $b_{21}$  (wave at terminated output with source at input) measurement with the receiver frequency defined by defined by the **Freq Reference**, **Input Freq Offset**, and/or **Input Freq Scale** buttons found in the System instrument panel. The resulting data is corrected absolute power, with default units of Watts.

*NOTE: The phase is only defined within a test and not with any other readings.*

**PANEL: PULSE AND SEQUENCE**

Pulse Width

0

**Pulse Width**

Decimal notation input button in units of  $\mu\text{s}$  used in premeasure groups to generate a narrow RF pulse by switching the Source 1 Mode solid-state switch (*M11-T* in the block diagram) from the *Src 1* (C1) port to the internal *Noise Source 1* port. This button is used in conjunction with the **Measure Mode:pulse** button setting and **Src 1 Seq** button.

Src 1 Seq

restore

**Src 1 Seq**

This drop down list selection button is used strictly in premeasure groups to temporarily override buttons that control the routing of the *M26-T* solid state switch in s/wave parameter measurements for custom RF pulse applications.

The 'restore' selection reverts the switch settings and control back to the last panel, section default, or global defaults set by the buttons found in the RF Setup panel.

The 'pulse on' selection activates the RF pulse signal defined by the **Pulse Width** button.

The 'pulse off' selection deactivates the RF pulse signal defined by the **Pulse Width** button.

The 'Rf 3' selection sets the *M26-T* switch to route the RF pulse signal to the 'src1-noise' port of the *R-3* relay.

The 'Rf 6' selection sets the *M26-T* switch to route the RF pulse signal to the 'src1-noise' port of the *R-6* relay.

The 'Rf 7' selection sets the *M26-T* switch to route the RF pulse signal to the 'src1-noise' port of the *R-7* relay.

Measure Mode

CW

**Measure Mode**

This drop down list selection button is used in test panels or section defaults to control the state of the RF pulse width function. The default start position is the *Noise Source 1* path (effectively disconnected from *Src 1* (C5) input).

The 'cw' selection is the default value and provides continuous wave operation.

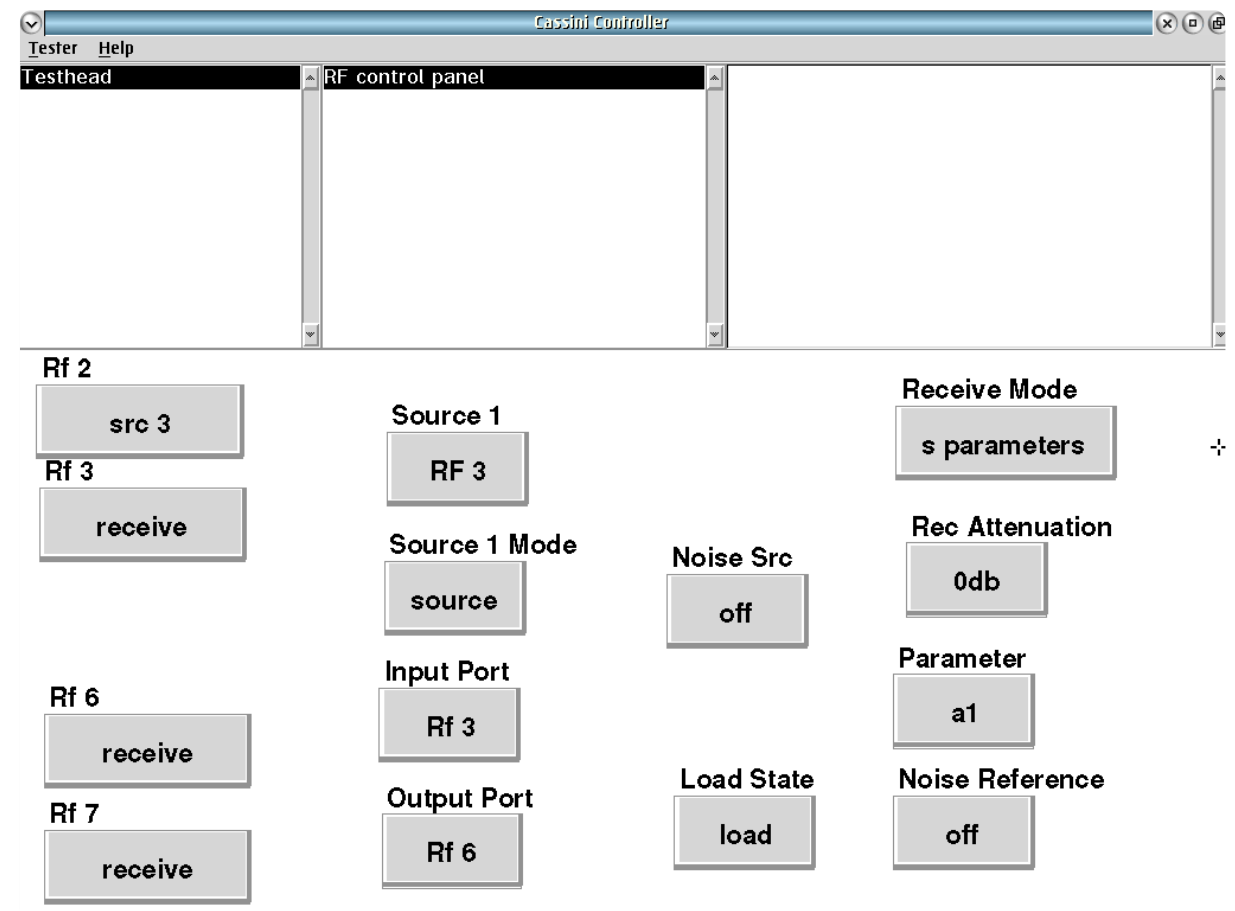
The 'pulse' selection enables short duration sourcing operation with the **Pulse Width** button setting defining the pulse duration and the **Src 1 Seq** button defining the signal routing.



## CONTROL PANELS

Real-time control of the routing of instruments through this TIM.

### CONTROL PANELS 4 RI8545 0.1 TO 20GHZ TESTSET



RF Control Panel provides real time control of routing through the Testset.

## Rf 2

Configure the connections to this RF port. Either a connection to Source1 or to Source3.

## Rf 3

Configure the connections to this RF port. Either a connection to Source1-Noise source or the receive path.

## Rf 6

Configure the connections to this RF port. Either a connection to Source1-Noise source or the receive path.

## Rf 7

Configure the connections to this RF port. Either a connection to Source1-Noise source or the receive path.

## Source 1

Sets the port which is connected to Source1.

## Source 1 Mode

Set the Source1 mode to be either the RF source or a noise source.

## Input Port

Select the input port for measurement. Independent of the “Rf” port connections, this button selects which port to measure as the input.

## Output Port

Select the output port for measurement. Independent of the “Rf” port connections, this button selects which port to measure as the input.

## Noise Src

Turn the noise source used for noise figure on and off.

## Load State

Sets the state for the output port to load.

## Receive Mode

Sets the receive path to receive using the noise detector (scalar) or s-parameter detector (vector with phase and magnitude).

## Rec Attenuation

Set the attenuation in the s-parameter and power measurement paths.

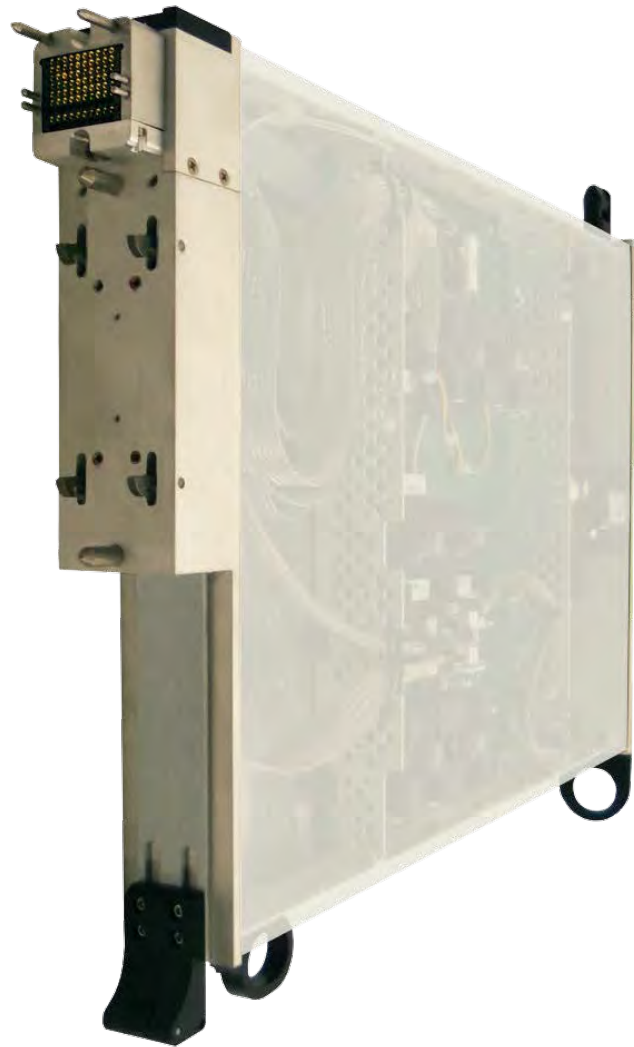
## Parameters-parameter

Select the wave parameter for measurement,  $a_1$  is incident.

## Noise Reference

Turn the noise source used for drift calibration on and off.

# RI8546: DEVICE POWER/ MEASURE



## TOPICS

---

[Instruments Provided by this TIM](#)

[Edit Panel Button Descriptions](#)

[Static Digital Button Modes](#)

[Control Panel](#)

Tap the links above to quickly access content

## INSTRUMENTS PROVIDED BY THIS TIM

The instrument in this TIM appear as **DutControl**, **PowerVI**, **StaticDigital** in the panel dialog windows.

Model and Name as it appears in the Tester Configuration:

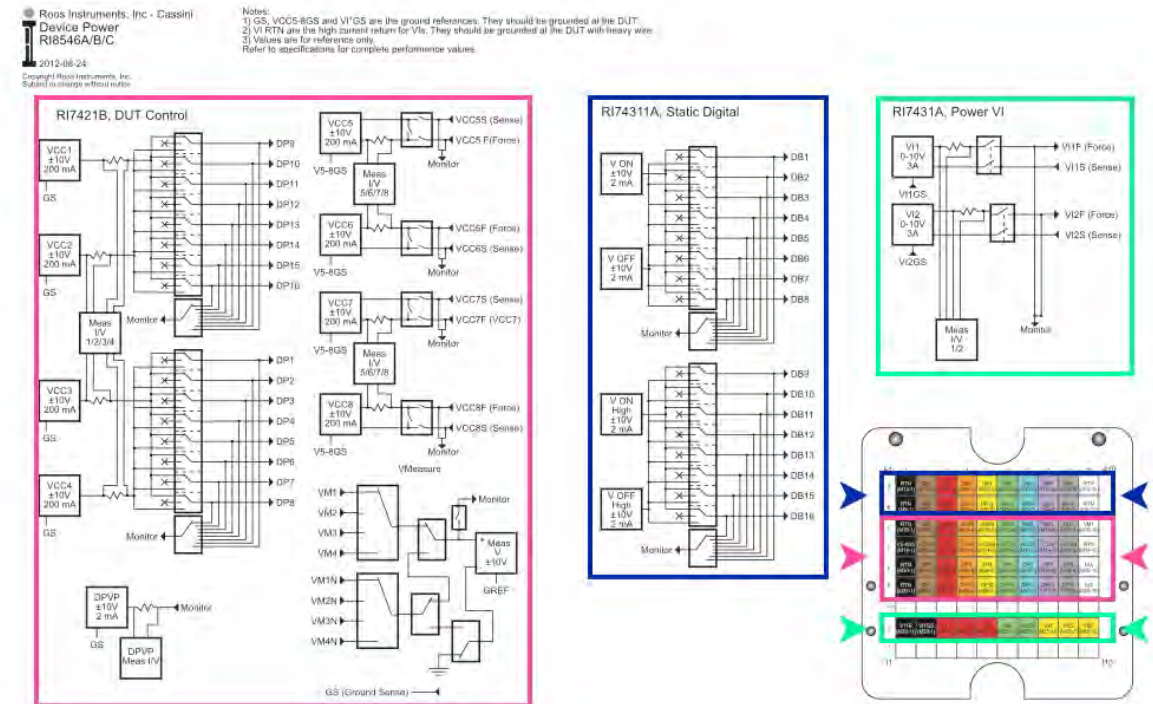
- DutControl, Ri7421x Dut Control
- PowerVI, RI7431x High Current Supplies
- StaticDigital, RI74311x 16-bit Device Digital Controller

*NOTE: Multiple RI8546 instruments are enumerated incrementally by the system as “2”, “3”, etc. in the configuration, edit, and control panels (i.e - DutControl, PowerVI, StaticDigital ; DutControl2, PowerVI2, StaticDigital2; DutControl3, PowerVI3, StaticDigital3 ; etc.).*

*The “x” in the instrument names denotes the model revision number.*

## DIAGRAM 1 RI8546 DEVICE POWER - INSTRUMENTS

### ▶ Device Power Block Diagram

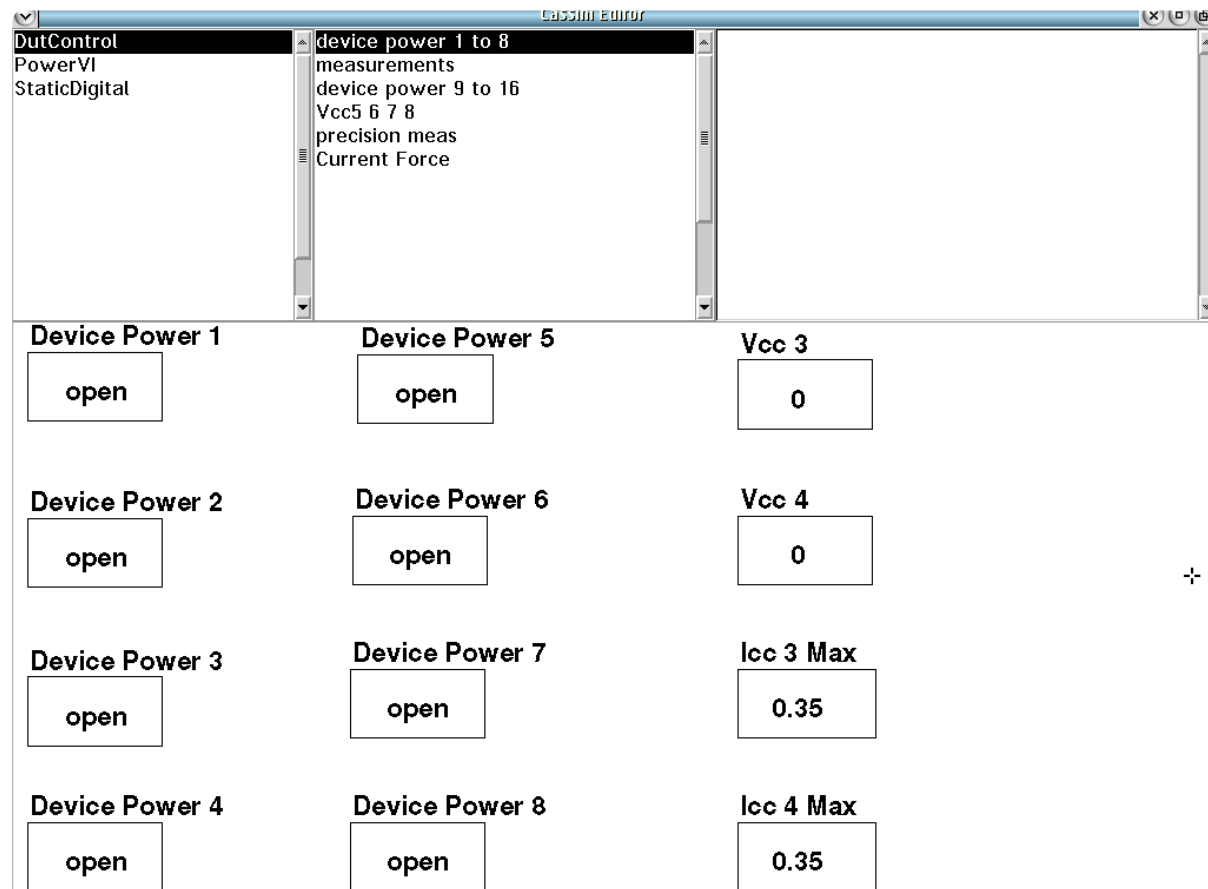


DUT Control, Static Digital, and Power VI instruments with the RI8546

## EDIT PANELS

Automated control of the instruments in this TIM with use by the Test Plan Editor.

### EDIT PANELS 6 RI8546 DEVICE POWER



DUTControl **device power 1 to 8** provide access to individual pin states and shared control of Voltage and Current.

## DUTCONTROL

### PANEL: DEVICE POWER 1 TO 8

See [Example D](#) at the end of the Edit Panels section for example measurements using the device power pins.



### Device Power 1 through Device Power 8

Drop down list buttons that individually control the state of each of the power supply pins independently. This bank of 8 device power pins can be connected to a voltage or current resource (*Meas I/V 1/2/3/4*), a precision voltage measure resource (*Monitor→DPVP Meas I/V*), or power supplies *VCC3* and/or *VCC4* via a switching network in the DUT Control subsystem, see [Diagram 1](#).

The default 'open' selection disconnects the designated Device Power pin from all instrument resources by setting the switch state to the "open" position, leaving the pin in a DC floating state.

The 'Vcc3' selection connects the designated Device Power pin to the *VCC3 ±10 V, 200 mA* power supply for sourcing DC voltage. This setting is used with the **Vcc3** and **Icc3 Max** buttons.



The 'Vcc4' selection connects the designated Device Power pin to the  $VCC4 \pm 10 V, 200 mA$  power supply for sourcing DC voltage. This setting is used with the **Vcc4** and **Icc4 Max** buttons.

The 'both' selection connects  $VCC3 \pm 10 V, 200 mA$  and  $VCC4 \pm 10 V, 200 mA$  power supplies in parallel to the designated Device Power pin for sourcing DC voltage. This mode is used for supplying drive currents up to 450 mA with Device Power pins. This setting is used with the **Vcc3**, **Icc3 Max**, **Vcc4**, and **Icc4 Max** buttons.

*NOTE: The Vcc3 and Vcc4 buttons must be set to the same voltage and the Icc3 Max/Icc4 Max buttons must be set to the same expected current value for proper function.*

The 'precision' selection connects the designated Device Power pin to the precision voltage measure instrument *DPVP Meas I/V* via the *monitor* multiplexer. This mode is used for measuring currents in the pA range and for force voltage or current and measure current/voltage measurements.

### Vcc 3

Vcc 3  
0

Decimal notation input button that sets the voltage for the  $VCC3 \pm 10 V, 200 mA$  power supply that services Device Power pins 1-8. The input is in units of volts with a resolution of 0.3mV and a voltage accuracy of  $\pm 10 mV$ .

### Vcc 4

Decimal notation input button that sets the voltage for the  $VCC4 \pm 10 V, 200 mA$  power supply that services Device Power pins 1-8. The input is in units of volts with a resolution of 0.3mV and a voltage accuracy of  $\pm 10 mV$ .

Vcc 4  
0

### Icc 3 Max

Decimal notation input button that sets the maximum current limit for  $VCC3 \pm 10 V, 200 mA$  power supply that services Device Power pins 1-8. This is used to prevent excessive current from damaging DUT pins in the event of DC shorts or DUT failures. The input is in units of amps with a resolution of 10 $\mu A$ . A negative current value will sink the specified current value from the Device Power pin/s connected to VCC3.

Icc 3 Max  
0.35

*NOTE: Clamping the current value for VCC3 below the required drive voltage can result in insufficient voltage at the designated Device Power pin.*

Icc 4 Max

0.35

**Icc 4 Max**

Decimal notation input button that sets the maximum current limit for  $VCC4 \pm 10 V$ , 200 mA power supply that services Device Power pins 1-8. This is used to prevent excessive current from damaging DUT pins in the event of DC shorts or DUT failures. The input is in units of amps with a resolution of 10 $\mu$ A. A negative current value will sink the specified current value from the Device Power pin/s connected to VCC4.

*NOTE: Clamping the current value for VCC4 below the required drive voltage can result in insufficient voltage at the designated Device Power pin.*

**PANEL: MEASUREMENTS**

See [Example D](#) at the end of the Edit Panels section for example measurements using the Vmeasure pins.

Voltage Meas Max

10

**Voltage Meas Max**

Decimal notation input button that sets the maximum expected voltage amplitude for DC voltage measurements using the *Meas I/V 1/2/3/4* (VCC1/VCC2/VCC3/VCC4), *Meas I/V 5/6/7/8* (VCC5/VCC6/VCC7/VCC8), or *VMeasure* resources (VM1-VM4/VM1N-VM4N). The setting optimizes the dynamic range of the internal ADC's input to within one of four voltage ranges: <10 V, <1 V, <100 mV, and <10 mV (i.e - a button value of 150 mV will select the input range to <1 V for the ADC). Input values are in units of volts with a maximum value of 10 V. Input values are in units of volts with a maximum value of 10 V. This button is commonly used with the **Vmeasure** and/or **Voltage Meas Mode** buttons and paired with a **Voltage** measurement block.

Current Meas Max

1

**Current Meas Max**

Decimal notation input button that sets the maximum expected current amplitude for DC current measurements using the *Meas I/V*

1/2/3/4 (VCC1/VCC2/VCC3/VCC4), Meas I/V 5/6/7/8 (VCC5/VCC6/VCC7/VCC8), or VMeasure resources (VM1-VM4/VM1N-VM4N). The setting optimizes the dynamic range of the internal ADC's input to within one of four sense resistor ranges: <250 mA, <25 mA, <2.5 mA, and <250  $\mu$ A (i.e - a button value of 10 mA will select the dynamic range to <25 mA for the ADC). Input values are in units of amps with an effective maximum value of 250 mA. This button is commonly used with the **Imeasure** and/or **Imeasure Bw** buttons and paired with a **Current** measurement block.

Samples

21

## Samples

Decimal notation-value button that sets the total number of samples in a voltage versus time measurement. This button is commonly used with the **Meas Rate** button and **Voltage Vs Time** measurement block.

*NOTE: Maximum number of samples is 100.*

Voltage Meas Mode

single

## Voltage Meas Mode

Drop down list button that sets the mode of the Vmeasure resources (VM1-VM4/VM1N-VM4N). This button is commonly used with the **Vmeasure** and **Voltage Meas Max** buttons.

The 'single' selection measures voltages on VM1-VM4 or VM1N-VM4N pins individually as single-ended or ground-referenced voltage measures using a fast 12-bit DAC.

The 'single-Hi Res' selection measures voltages on VM1-VM4 or VM1N-VM4N pins individually as single-ended or ground-referenced voltage measures using a precision 24-bit DAC with 17mS/sample rate.

The 'diff' selection measures differential voltages on VM1-VM4 and VM1N-VM4N pin pairs (i.e. - the voltage across pins VM1 and VM1N or VM4 and VM4N) using a fast 12-bit DAC.

The 'diff-Hi Res' selection measures differential voltages on VM1-VM4 and VM1N-VM4N pin pairs using a precision 24-bit DAC with 17mS/sample rate.

## Imeasure

Drop down list button that chooses the resource pin for a current measurement. The list options are any of the *Device Power* supplies (VCC1, VCC2, ..VCC8). This button is paired with a **Current** measurement block.

Imeasure

Vcc1

## Meas Rate

Decimal notation input button that sets the measure sample rate for a voltage versus time measurement. The sample rate is in units of Hz with a maximum value of 50 kHz. This button is paired with a **Voltage Vs Time** button within a test panel and is commonly used with a **Samples**, **Voltage Meas Max**, and **Vmeas** button within a test panel/section default.

Meas Rate

20000

## Vmeasure

Drop down list button that chooses the resource pin for a voltage measurement. The list options are any *Vmeasure* resource pin (VM1-VM4/VM1N-VM4N) or one of the *Device Power* supplies (VCC1,

Vmeasure

Vm1

VCC2, ..VCC8). This button is paired with a **Voltage** measurement block.

## Imeasure Bw

Drop down list button that sets the bandwidth of the current measurement resource within *Meas I/V 1/2/3/4* and/or *Meas I/V 5/6/7/8*.

The 'fast' selection is the default mode.

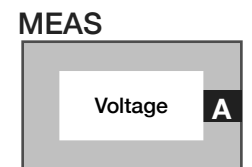
The 'slow' selection is used to reduce noise for sensitivity and/or low-current (<2.5mA) measurements.

Imeasure Bw

fast

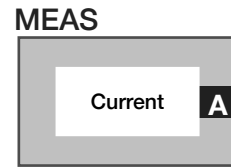
## Meas: Voltage

Measurement block that evaluates the voltage at a resource pin selected by the **Vmeasure** button. The measurement result is in units of volts, with a maximum measure value of  $\pm 10V$  DC.



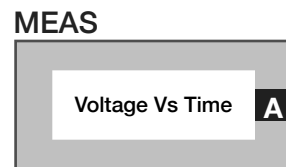
## Meas: Current

Measurement block that evaluates the current at a resource pin selected by the **Imeasure** button. The measurement result is in units of amps.



## Meas: Voltage Vs Time

Measurement block that evaluates the voltage relative to time at pin selected by the **Vmeasure** button. This button uses the **Samples** and **Meas Rate** to configure the measurement parameters. Results are output in RiVoltageVsTimeInt data type.



## PANEL: DEVICE POWER 9 TO 16

See [Example D](#) at the end of the section for example measurements using the Device Power pins.



### Device Power 9 through Device Power 16

Drop down list buttons that individually control the state of each of the power supply pins independently. This bank of 8 device power pins can be connected to a voltage or current resource (Meas I/V 1/2/3/4), a precision voltage measure resource (Monitor→DPVP Meas I/V), or power supplies VCC1 and/or VCC2 via a switching network in the DUT Control subsystem, see [Interactive 8](#).

The default 'open' selection disconnects the designated Device Power pin from all instrument resources by setting the switch state to the "open" position, leaving the pin in a DC floating state.

The 'Vcc1' selection connects the designated Device Power pin to the VCC1 ±10V, 200mA power supply for sourcing DC voltage. This setting is used with the **Vcc1** and **Icc1 Max** buttons.

The 'Vcc2' selection connects the designated Device Power pin to the VCC2 ±10V, 200mA power supply for sourcing DC voltage. This setting is used with the **Vcc2** and **Icc2 Max** buttons.



The 'both' selection connects  $VCC1 \pm 10V, 200mA$  and  $VCC2 \pm 10V, 200mA$  power supplies in parallel to the designated Device Power pin for sourcing DC voltage. This mode is used for supplying drive currents up to 450mA with Device Power pins 9 through 16. This setting is used with the **Vcc1**, **Icc1 Max**, **Vcc2**, and **Icc2 Max** buttons.

*NOTE: The Vcc1 and Vcc2 buttons must be set to the same voltage and the Icc1 Max/Icc2 Max buttons must be set to the same expected current value for proper function.*

The 'precision' selection connects the designated Device Power pin to the precision voltage measure instrument *DPVP Meas I/V* via the *Monitor* multiplexer. This mode is used for measuring currents in the pA range and for force voltage or current and measure current/voltage measurements.

### Vcc 1

Vcc 1  
0

Decimal notation input button that sets the voltage for the  $VCC3 \pm 10V, 200mA$  power supply that services Device Power pins 9-16. The input is in units of volts with a resolution of 0.3mV with a voltage accuracy of  $\pm 10mV$ .

### Vcc 2

Decimal notation input button that sets the voltage for the  $VCC2 \pm 10V, 200mA$  power supply that services Device Power pins 9-16. The input is in units of volts with a resolution of 0.3mV and a voltage accuracy of  $\pm 10mV$ .

Vcc 2  
0

### Icc 1 Max

Decimal notation input button that sets the maximum current limit for  $VCC1 \pm 10V, 200mA$  power supply that services Device Power pins 9-16. This is used to prevent excessive current from damaging DUT pins in the event of DC shorts or DUT failures. The input is in units of amps with a resolution of  $10\mu A$ . A negative current value will sink the specified current value from the Device Power pin/s connected to VCC1.

Icc 1 Max  
0.35

*NOTE: Clamping the current value for VCC1 below the required drive voltage can result in insufficient voltage at the designated Device Power pin.*

**Icc 2 Max**

Decimal notation input button that sets the maximum current limit for  $VCC2 \pm 10V$ , 200mA power supply that services Device Power pins 9-16. This is used to prevent excessive current from damaging DUT pins in the event of DC shorts or DUT failures. The input is in units of amps with a resolution of 10 $\mu$ A. A negative current value will sink the specified current value from the Device Power pin/s connected to VCC2.

*NOTE: Clamping the current value for VCC2 below the required drive voltage can result in insufficient voltage at the designated Device Power pin.*

Icc 2 Max

0.35

**PANEL: VCC5 6 7 8**

See [Example D](#) at the end of the Edit Panels section for example measurements using the VCC pins.

Vcc 5

0

**Vcc 5 through Vcc 8**

Decimal notation input buttons that set the individual voltage for the associated, independent power supplies ( $VCC5$ ,  $VCC6$ ,  $VCC7$ ,  $VCC8$ ). The input is in units of volts with a resolution of 0.3mV and a voltage accuracy of  $\pm 10$ mV.

Vcc 5 Sense

internal

**Vcc 5 Sense through Vcc 8 Sense**

Drop down list buttons that sets the feedback voltage sense mode for the associated independent power supplies ( $VCC5$ ,  $VCC6$ ,  $VCC7$ ,  $VCC8$ ). The voltage sense feedback system regulates the voltage value of the supply/pin.

The 'internal' selection sets the voltage feedback mode to use the internal sense resistor and *Meas I/V 5/6/7/8* resource connected between the power supply the associated VCC pin. For example, between the  $VCC6 \pm 10V$ , 200mA power supply and  $VCC6F$  (*Force*) pin.

The 'external' selection sets the voltage feedback mode to use the sense line (i.e. - for  $VCC6F$ , the  $VCC6S$  pin would be used to provide voltage feedback regulation. This mode is used to compensate for ohmic losses in the device interface between the resource output pin on the TIM and the device under test. The  $VCC\#S$  (Sense) pin is connected in near the device pin using the associated  $VCC\#F$  (Force) pin, providing a low-loss DC feedback path to compensate for voltage loss and ensure accurate voltage at the device pin.

#### Vcc 5 Output

off

### Vcc 5 Output through Vcc 8 Output

Drop down list buttons that control the individual relays between the power supplies ( $VCC5 \pm 10V$ , 200 mA;  $VCC6 \pm 10V$ , 200 mA;  $VCC7 \pm 10V$ , 200 mA;  $VCC8 \pm 10V$ , 200 mA and the  $VCC\#$  force/sense resource pins).

The 'on' selection connects the supply to its associated resource pins.

The 'off' selection disconnects the supply from its associated resource pins.

#### Icc 5 Max

0.35

### Icc 5 Max through Icc 8 Max

Decimal notation input buttons that set the individual maximum current limit for the independent power supplies ( $VCC5 \pm 10V$ , 200 mA;  $VCC6 \pm 10V$ , 200 mA;  $VCC7 \pm 10V$ , 200 mA;  $VCC8 \pm 10V$ , 200 mA). This is used to prevent excessive current from damaging DUT pins in the event of DC shorts or DUT failures. The input is in units of amps with a resolution of 10  $\mu A$ . A negative current value will sink the specified current value from the associated  $VCC\#F$  (Force) pin/s.

*NOTE: Clamping the current value for VCCs below the required drive voltage can result in insufficient voltage at the resource pin.*

**PANEL: PRECISION MEAS**

See [Example D](#) at the end of the Edit Panels section for example measurements using the precision measure resource.

Measure Mode  
none

**Measure Mode**

Drop down list button that sets the mode of the precision measure instrument (*DPVP Meas I/V*).

The 'none' selection disconnects the precision measure resource from the *monitor* line.

The 'vm' selection is the volt meter mode. This provides precision voltage measure with an extremely high series resistance (1M $\Omega$ ) much the same as a standard volt meter.

The 'lmeas' selection forces a voltage defined by the **Measure V Force** button and measures the resulting current for the selected resource using the **Measure Pin**. The **Measure I Limit** button restricts the maximum amount of current delivered by the supply (*DPVP  $\pm 10$  V, 2 mA*) during the measurement to avoid damaging the device pin if there is a DUT failure.

The 'vMeas' selection forces a current defined by the **Measure I Force** button and measures the resulting voltage for the selected resource using the **Measure Pin**. The **Measure V Limit** button

restricts the maximum voltage applied by *DPVP  $\pm 10$  V, 2 mA* during the measurement. Typically the **Measure V Limit** button is set to the DUT's supply rail or ground depending on the polarity of the **Measure I Force** button to avoid damaging the device pin.

*NOTE: This mode is typically used for continuity tests or testing protection diodes on DUT pins.*

The 'low Current' selection measures the current for a selected resource defined by the **Measure Pin**. This mode sets the precision measure's sense resistor to its lowest current measurement range and incorporates a built-in, recursive averaging method to measure DC currents in the pA range.

The 'vCal' selection is the same mode as the 'vMeas' mode with the exception that the current limit settings are deactivated. The value set with the **Measure I Limit** is ignored, and the supply (*DPVP  $\pm 10$  V, 2 mA*) will push as much available current as possible to force the voltage defined by the **Measure V Force** button.

*NOTE: This mode is typically used in continuity tests for device pins with large in-rush currents or long duration time constants during power up.*

The 'iCal' selection is the same mode as the 'lmeas' mode with the exception that the voltage limit settings are deactivated. The value set with the **Measure V Limit** is ignored, and the supply (*DPVP  $\pm 10$  V, 2*

*mA*) will provide as much available voltage as possible to force the current condition defined by the **Measure I Force** button.

*NOTE: Use caution with this mode, as pin voltages can exceed the rail voltages of the device under test.*

### Vcc Measure Pin

Drop down list button that chooses which of the independent VCC supplies ( $VCC5 \pm 10V, 200 mA$ ;  $VCC6 \pm 10V, 200 mA$ ;  $VCC7 \pm 10V, 200 mA$ ;  $VCC8 \pm 10V, 200 mA$ ) to measure with the precision measure instrument (*DPVP Meas I/V*) via the *Monitor* connection.

Vcc Measure Pin

None

### Measure V Force

Decimal notation button that sets the value of the voltage force condition for the **Measure Mode**: 'lmeas' setting. The condition is applied to the resource designated by the **Vcc Measure Pin** or **Measure Pin** button. The values are input in units of volts.

Measure V Force

0

Measure I Force

0

### Measure I Force

Decimal notation button that sets the value of the current force condition for the **Measure Mode**: 'vMeas' setting. The condition is applied to the resource designated by the **Vcc Measure Pin** or **Measure Pin** button. The values are input in units of amps.

*NOTE: Setting a value of 0 can cause unexpected or irregular current or voltage measurement conditions at the device pin.*

Measure V Limit

0

### Measure V Limit

Decimal notation input button that sets the maximum voltage amplitude for the **Measure Mode**: 'vMeas' button setting. This setting enables internal voltage-limiting in the precision measure supply ( $DPVP \pm 10V, 2 mA$ ) to prevent damaging a DUT pin from unwanted and/or excessive voltage caused by the **Measure I Force** button current criterion.



**Measure I Limit**

0

**Measure I Limit**

Decimal notation input button that sets the maximum current amplitude for the **Measure Mode**: 'lmeas' button setting. This setting enables internal current-limiting diodes in the precision measure's supply ( $DPVP \pm 10V, 2 mA$ ) to prevent damaging a DUT pin from unwanted and/or excessive current caused by the the **Measure V Force** button voltage criterion.

*NOTE: Setting a value of 0 can cause unexpected or irregular current/voltage measurement conditions at the device pin.*

**Current Meas Max**

1

**Current Meas Max**

The decimal notation input button optimizes the dynamic range of the internal ADC's input to within one of four sense resistor ranges: <2 mA, <200  $\mu A$ , <20  $\mu A$ , and <2  $\mu A$  (i.e. a button value of 500 mA will select the dynamic range to <2 mA for the ADC). This button is used with the **Measure Mode**: 'lmeas', 'iCal', or 'low Current', **Measure Pin**, and or **Vcc Measure Pin** buttons.

**Measure Pin**

none

**Measure Pin**

Drop down list button that choose the pin resource to be measured. This button is used with the **Measure Mode** button and associated measurement parameter buttons defined therein.

**Measure Time**

0

**Measure Time**

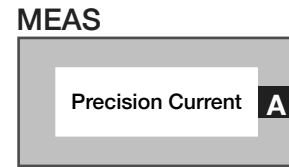
Decimal notation input button that sets the measurement span in units of seconds for the **Precision VoltageVsTime** and **Precision CurrentVsTime** measurement blocks. This button is used with the **Meas Rate** button, where the total number of samples (i.e **Meas Rate** \* **Measure Time** values) must not exceed 2000.

**Measure Rate**

20000

**Meas Rate**

Decimal notation input button used with the **Measure Time** button that defines the sample rate for **Precision VoltageVsTime** and **Precision CurrentVsTime** measurement blocks. The button value is listed in units of Hz with a maximum sample rate of 50 kHz.



## Meas: Precision Current

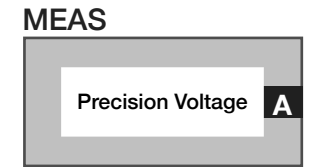
Measurement block that computes the current at a resource pin via the *Monitor*→*DPVP Meas I/V*. The maximum measurable current is 2 mA. A resource to measure is selected by one of the following buttons or groups of buttons:

**Measure Pin** button found in the “precision meas” instrument panel of the DutControl for one for one of the device power buttons: DP1..DP16

**Measure Pin:** ‘Vm’ button found in the “precision meas” panel of the DutControl instrument, **Vmeasure** (to select which Vmeasure pin: VM1..4 or VM1N..VM4N), and **Voltage Meas Mode:** ‘single-Hi Res’ buttons found in the “measurements” instrument panel of the DutControl.

**Measure Pin** button found in the “measure” panel of the StaticDigital instrument for DB1..DB16.

**Measure Pin** button found in the “measurements” panel of the PowerVI instrument for V1 or V2.



## Meas: Precision Voltage

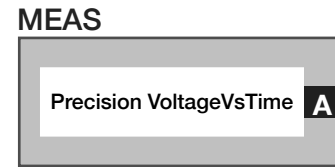
Measurement block that computes the voltage at a resource pin via the *Monitor*→*DPVP Meas I/V*. The maximum measurable voltage is  $\pm 10$  V. A resource to measure is selected by one of the following buttons or groups of buttons:

**Measure Pin** button found in the “precision meas” panel of the DutControl instrument for one for one of the device power buttons: DP1..DP16

**Measure Pin:** ‘Vm’ button found in the “precision meas” panel of the DutControl instrument, **Vmeasure** (to select which Vmeasure pin: VM1..4 or VM1N..VM4N), and **Voltage Meas Mode:** ‘single-Hi Res’ buttons found in the “measurements” instrument panel of the DutControl.

**Measure Pin** button found in the “measure” panel of the StaticDigital instrument for DB1..DB16.

**Measure Pin** button found in the “measurements” panel of the PowerVI instrument for V1 or V2.



## Meas: Precision VoltageVsTime

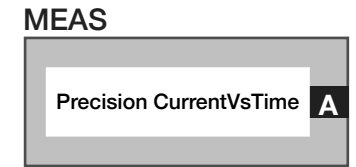
Measurement block that computes sampled voltage over time at a resource pin via the *Monitor→DPVP Meas I/V*. This block uses the **Measure Time** and **Meas Rate** buttons to define the sampling parameters. The maximum measurable voltage is  $\pm 10$  V. A resource to measure is selected by one of the following buttons or groups of buttons:

**Measure Pin** button found in the “precision meas” panel of the DutControl instrument for one for one of the device power buttons: DP1..DP16

**Measure Pin:** ‘Vm’ button found in the “precision meas” pane of the DutControl instrument, **Vmeasure** (to select which Vmeasure pin: VM1..4 or VM1N..VM4N), and **Voltage Meas Mode:** ‘single-Hi Res’ buttons found in the “measurements” instrument panel of the DutControl.

**Measure Pin** button found in the “measure” panel of the StaticDigital instrument for DB1..DB16.

**Measure Pin** button found in the “measurements” panel of the PowerVI instrument for V1 or V2.



## Meas: Precision CurrentVsTime

Measurement block that outputs sampled current over time at a resource pin via the *Monitor→DPVP Meas I/V*. This block uses the **Measure Time** and **Meas Rate** buttons to define the sampling parameters. The maximum measurable current is 2 mA. A resource to measure is selected by one of the following buttons or groups of buttons:

**Measure Pin** button found in the “precision meas” panel of the DutControl instrument for one for one of the device power buttons: DP1..DP16

**Measure Pin:** ‘Vm’ button found in the “precision meas” panel of the DutControl instrument, **Vmeasure** (to select which Vmeasure pin: VM1..4 or VM1N..VM4N), and **Voltage Meas Mode:** ‘single-Hi Res’ buttons found in the “measurements” instrument panel of the DutControl.

**Measure Pin** button found in the “measure” panel of the StaticDigital instrument for DB1..DB16.

**Measure Pin** button found in the “measurements” panel of the PowerVI instrument for V1 or V2.

## PANEL: CURRENT FORCE

See [Example D](#) at the end of the Edit Panels section for example measurements using the current force modes.

Vcc 1 Mode

voltage

### Vcc 1/3/5/7 Mode

Drop down list buttons that individually set the modes of the independent supplies  $VCC1 \pm 10 V, 200 mA$ ,  $VCC3 \pm 10 V, 200 mA$ ,  $VCC5 \pm 10 V, 200 mA$ , or  $VCC7 \pm 10 V, 200 mA$ .

The ‘voltage’ selection sets the associated supply to operate as a voltage source, maintaining a fixed voltage value specified by the **Vcc 1**, **Icc 3**, **Icc 5**, or **Vcc 7** buttons, independent of the load resistance or output current (up to ~230 mA) on the designated supply pin.

The ‘current’ selection sets the associated supply to operate as a current source, delivering or absorbing a current specified by the **Icc 1**, **Icc 3**, **Icc 5**, or **Icc 7** buttons, independent of voltage on the designated supply pin. The **Vcc 1/3/5/7 Max** and **Vcc 1/3/5/7 Min** buttons clamp the voltage swing range within a user-specified range for this mode.

The ‘vExtS’ selection sets the supply to operate as a voltage source, using the external sense pin resource as a feedback loop to force a “calibrated” voltage value specified by the **Vcc 1**, **Icc 3**, **Icc 5**, or **Vcc**

**7** buttons. The sense feedback corrects for ohmic losses through the device interface, providing a corrected voltage value at the DUT pin that is independent of the load resistance or output current (up to ~230 mA) on the designated supply pin.

*NOTE: The sense resource pin must be connected to the supply resource pin close to the DUT to provide accurate voltage-sense feedback correction. It is recommended to use low-loss wire.*

Icc 1

0

### Icc 1/3/5/7

Decimal notation input buttons that define the independent forcing current conditions for  $VCC1 \pm 10 V, 200 mA$ ,  $VCC3 \pm 10 V, 200 mA$ ,  $VCC5 \pm 10 V, 200 mA$ , or  $VCC7 \pm 10 V, 200 mA$  supplies. The range of valid input values is  $\pm 200 mA$  with a resolution of  $10 \mu A$ . This button is used with its associated **Vcc 1/3/5/7 Mode**: ‘current’ button, and **Vcc 1/3/5/7 Min/Max** buttons.

*NOTE: Only VCC1, VCC3, VCC5, and VCC7 supplies are capable of functioning as current sources. Setting a value of 0 can cause unexpected or irregular current or voltage measurement conditions at the device pin.*

**Vcc 1/3/5/7 Max**

Decimal notation input buttons that define the independent maximum voltage condition for  $VCC1 \pm 10 V, 200 mA$ ,  $VCC3 \pm 10 V, 200 mA$ ,  $VCC5 \pm 10 V, 200 mA$ , or  $VCC7 \pm 10 V, 200 mA$  supplies when in current mode. The setting switches in clamping diodes to define an upper voltage limit that is used to prevent a resource voltage pin from exceeding a DUT's rail voltage. This button is used with the **Vcc 1/3/5/7 Mode**: 'current' button, and **Vcc 1/3/5/7 Min** buttons.

**Vcc 1 Max**

15

**Vcc 1/3/5/7 Min**

Decimal notation input buttons that define the independent minimum voltage condition for  $VCC1 \pm 10 V, 200 mA$ ,  $VCC3 \pm 10 V, 200 mA$ ,  $VCC5 \pm 10 V, 200 mA$ , or  $VCC7 \pm 10 V, 200 mA$  supplies when in current mode. This button switches in clamping diodes to define the lower voltage limit used to prevent a resource voltage pin from exceeding a DUT's rail or ground voltage. This button is used with the **Vcc 1/3/5/7 Mode**: 'current' button, and **Vcc 1/3/5/7 Max** buttons.

**Vcc 1 Min**

-15

**POWERVI****PANEL: HI CURRENT POWER SUPPLIES**

See [Example D](#) at the end of the Edit Panels section for example measurements using the Power VI pins.

**Power V 1**

0

**Power V 1**

Decimal notation input button that sets the voltage value for the Power VI's  $VI1 0-10 V, 3 A$  high-current supply. Range of valid input values are 0 to 10 in units of volts. This button is used with the **Power I 1** and **V1 Output** buttons.

**Power V 2**

0

**Power V 2**

Decimal notation input button that sets the voltage value for the Power VI's  $VI2 0-10 V, 3 A$  high-current supply. Range of valid input values are 0 to 10 in units of volts. This button is used with the **Power I 2** and **V2 Output** buttons.



## Power I 1

Decimal notation input button that sets the maximum current limit value for the Power VI's *VI1 0-10 V, 3 A* high-current supply. Input values are in units of amps with a range of 0 to 3 amps and 11 bits of resolution (~1.5 mA). This button is used with the **Power V 1** and **V1 Output** buttons.

Power I 1  
0

## Power I 2

Decimal notation input button that sets the maximum current limit value for the Power VI's *VI2 0-10 V, 3 A* high-current supply. Input values are in units of amps with a range of 0 to 3 amps and 11 bits of resolution (~1.5 mA). This button is used with the **Power V 2** and **V2 Output** buttons.

Power I 2  
0

## V 1 Output

Drop down list button that controls the output relay between the VI1F pins and the *VI1 0-10 V, 3 A* supply.

The 'on' connects the *VI1 0-10 V, 3 A* supply outputs to the VI1F pins.

V 1 Output  
off

The 'off' disconnects the *VI1 0-10 V, 3 A* supply outputs from the VI1F pins.

## V 2 Output

Drop down list button that controls the output relay between the VI2F pins and the *VI2 0-10 V, 3 A* supply.

The 'on' connects the *VI2 0-10 V, 3 A* supply outputs to the VI2F pins.

The 'off' disconnects the *VI2 0-10 V, 3 A* supply outputs from the VI2F pins.

V 2 Output  
off

## PANEL: MEASUREMENTS

See [Example D](#) at the end of this section for example measurements using the static digital measurements.

Voltage Meas Max

10

### Voltage Meas Max

Set the max magnitude for voltage measurement for the Power VI instrument's internal voltage or current measure resource *Meas I/V, 1/2*. This picks the range used.

Current Meas Max

1

### Current Meas Max

The Decimal notation input button that optimizes the dynamic range of the *Meas I/V, 1/2* resource's internal sense resistor and ADC input. This button is used with the **Imeasure** button, **Current Vs Time** and/or **Current** measurement blocks.

Vmeasure

V1

### Vmeasure

Drop down list button that connects the PowerVI's internal measure resource (*Meas I/V, 1/2*) to the selected high-current power supply for

voltage measurements. This button is used with the **Voltage Meas Max** button and **Voltage** measurement block or the **Meas Rate** and **Samples** buttons with the **Voltage Vs Time** measure block.

The 'V1' selection connects the *Meas I/V, 1/2* resource to the *VI1 0-10 V, 3 A* supply output for effectively measuring the VI1F pins.

The 'V2' selection connects the *Meas I/V, 1/2* resource to the *VI2 0-10 V, 3 A* supply outputs, for effectively measuring the VI2F pins.

Imeasure

V1

### Imeasure

Drop down list button that connects the PowerVI's internal measure resource (*Meas I/V, 1/2*) to the selected high-current power supply for current measurements. This button is used with the **Current Meas Max** button and **Current** measurement block or the **Meas Rate** and **Samples** buttons with the **Current Vs Time** measure block.

Meas Rate

20000

### Meas Rate

Decimal notation input button used with the **Samples** button that defines the sample rate for **Voltage Vs Time** and **Current Vs Time** measurement blocks in the Power VI instrument. The button value is listed in units of Hz with a maximum sample rate of 50 kHz.

## Samples

Decimal notation input button that sets the measurement span in units of seconds for the **Voltage Vs Time** and **Current Vs Time** measurement blocks. This button is used with the **Meas Rate** button. The measurement window is the values of **Meas Rate** \* **Sample**.

*NOTE: Maximum number of samples is 2000.*

Samples

21

## Measure Pin

Drop down list button that chooses the pin resource to be measured with the precision measure resource via the Monitor . This button is used with the **Measure Mode** button and associated measurement parameter buttons defined therein.

The 'V1' selection measures *V1 0-10 V, 3 A* supply with the internal *Meas I/V, 1/2* resource.

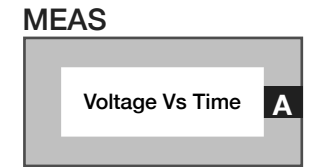
The 'V2' selection measures *V2 0-10 V, 3 A* supply with the internal *Meas I/V, 1/2* resource.

Measure Pin

None

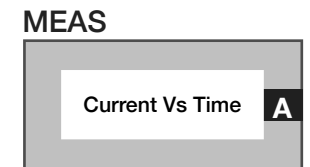
## Meas: Voltage Vs Time

Measurement block that computes sampled voltage over time at a PowerVI resource pin (designated by the **Vmeasure** button) via the internal *Meas I/V, 1/2* resource. This block uses the **Voltage Meas Max**, **Measure Rate**, and **Samples** buttons to define the sampling parameters. The maximum measurable voltage is  $\pm 10V$ .



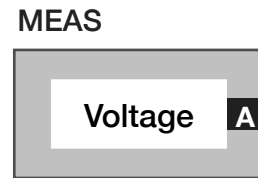
## Meas: Current Vs Time

Measurement block that outputs sampled current over time at a resource pin (designated by the **Imeasure** button via the *DPVP Meas I/V*). This block uses the **Current Meas Max**, **Measure Time**, and **Meas Rate** buttons to define the sampling parameters.



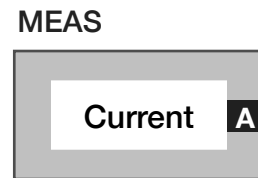
### Meas: Voltage

Measurement block that measures voltage at a PowerVI resource pin (designated by the **Vmeasure** button) via the internal *Meas I/V, 1/2* resource. This block uses the **Voltage Meas Max** button to optimize the internal ADC's dynamic range. The maximum measurable voltage is  $\pm 10V$ .



### Meas: Current

Measurement block that outputs sampled current over time at a resource pin (designated by the **Imeasure** button via the *DPVP Meas I/V*). This block uses the **Current Meas Max** button to optimize the internal ADC's sense resistors for maximum dynamic range.



### EXAMPLE D RI8546 DEVICE POWER MEASUREMENTS

The screenshot shows a graphical programming interface for device power measurements. At the top, it says "Section Defaults" and "Test State: Current Measurements". Below this, there is a list of tests: "Test: Imsr\_DP", "Test: Imsr\_Vcc5-8", "Test: Imsr, VI", and "Test: Mforce/Imsr\_DP". On the right side, there are "Run" and "Repeat" buttons. The main area contains several blocks: a "DutControl" block for "Device Power 1" with "Vcc 3" inside; a "DutControl" block for "Current Meas Max" with "250m", "Vcc3", and "fast" inside; and a "System" block for "Save Amps" with "Imsr\_DP1" inside. A "MEAS" block for "Current" is also visible, connected to the "Imsr\_DP1" block.

### Current Measurement with a Device Power(DP) Pin

## STATICDIGITAL

### PANEL: DEVICE DB

See [Diagram 2](#) at the end of the Edit Panels section for a timing diagram when using the Device Serial modes.

#### Von

Decimal notation input button that sets the fixed voltage level for the logic “on” state for the 8 Device Bit pins DB1 to DB8.

The valid input range is  $\pm 10$  volts.

Von

0

#### Voff

Decimal notation input button that sets the fixed voltage level for the logic “off” state for the 8 Device Bit pins DB1 to DB8.

The valid input range is  $\pm 10$  volts.

Voff

0

Db 1

open

### Db 1 through Db 16

Drop down list buttons that individually control the Device Bit line states. When the associated DB resource is used for serial communication, this button value defines the voltage or logical state of the pin before and after serial communication emits.

*NOTE: DB pins used for communication must be set to ‘on’, ‘off’, or ‘openCol’ (DB2 and DB10 only) within the bit stream emit test panel, section defaults, or global defaults.*

The ‘open’ selection disconnects the associated device bit pin from all internal resources, leaving it as a floating pin.

The ‘on’ selection connects the associated device bit pin to the V ON  $\pm 10V$ , 2 mA resource (Logic state “on”/high voltage value).

The ‘off’ selection connects the associated device bit pin to the V OFF  $\pm 10V$ , 2 mA resource (Logic state “off”/low voltage value).

The ‘openCol’ selection, which is only available on DB2 and DB10 configures these device bit pins as open collector. This mode requires the addition of a pull-up/pulldown resistor on DB2/DB11 either on the device interface board or within the fixture. It is typically used with I2C communication. See the **Serial Type: ‘I2C’** button mode for more details.



## Von High Byte

Decimal notation input button that sets the fixed voltage level for the logic “on” state for the 8 Device Bit pins DB9 to DB16 (high byte). The valid input range is  $\pm 10$  volts.

Von High Byte

0

## Voff High Byte

Decimal notation input button that sets the fixed voltage level for the logic “off” state for the 8 Device Bit pins DB9 to DB16 (high byte). The valid input range is  $\pm 10$  volts.

Voff High Byte

0

## PANEL: DEVICE SERIAL PORT

Data Read

None

### Data Read

Drop down list button that configures the appointed device bit pin (DB1..DB16) to acts as the serial read data pin. The DB line that is designated as the data read line is connected to the DUT’s data output pin to support data reads with speeds to 250 kHz. The **Serial Data Read** button defines the total number of bits to read from a bit stream.

*NOTE: The device bit lines DB1/DB9 (selection ‘Db1’ or ‘Db9’) support faster read speeds up to 1 MHz (with Data: ‘Db2’ or ‘Db10’ and Clock: ‘Db3’ or ‘Db11’ buttons).*

Clock

None

### Clock

Drop down list button that configures which DB pin acts as the serial clock pin. An arbitrary pin selection can support a maximum of 250 kHz. The **Serial Clock Period** button controls the clock speed and the **Serial Clock Polarity** button controls the polarity of the clock rise/fall edges relative to the data stream.

See [Diagram 2](#) for a timing diagram of strobe parameters.

*NOTE: The device bit lines DB3/DB11 (selection 'Db3' or 'Db11') support faster clock speeds up to 1 MHz (with Data Read: 'Db1' or 'Db9' and Data Read: 'Db2' or 'Db10' buttons).*

## Data

Drop down list button that configures which DB pin acts as the serial data write pin to the device under test. The DB line that is designated as the data line is connected to the DUT's data output pin to support data reads with speeds to 250 kHz. The **Serial Direction** button sets the emit order of the bit stream, i.e. most significant bit first or least significant bit first. The **Serial Size** button defines the total number of bits in a single emit stream.

*NOTE: The device bit lines DB2/DB10 (selection 'Db2' or 'Db10') support faster write speeds up to 1 MHz (with Data Read: 'Db1' or 'Db9' and Clock: 'Db3' or 'Db11' buttons).*

Data

None

Strobe 1

None

## Strobe 1

Drop down list button that configures which DB pin acts as a serial strobe or read/write/enable pin to the DUT. The DB line that is designated as the data line is connected to the DUT's strobe or enable pin (s) support for speeds up to 250 kHz.

Strobe 2

None

## Strobe 2

Drop down list button that configures which DB pin acts as a serial strobe or read/write/latch enable pin to the device under test. The DB line that is designated as the data line is connected to the DUT's strobe or enable pin (s) support speeds up to 250 kHz.

Serial Type

DUT Defined

## Serial Type

Drop down list button that defines the serial communication protocol for the selected device bit lines. The selection type inherits and enforces protocol timing behavior on the designated read data, data, clock, and strobe lines.

The 'DUT Defined' selection uses the communication parameters defined in the Device Control Editor under the Formats tab to enable protocol-aware communication with a DUT. It is typically used with devices that contain multiple registers with complex programmable functions. This button selection will override the settings for the **Clock Polarity, Serial Direction, Strobe Length, and Strobe Polarity** buttons found in the 'device serial port' panel. See the [DUT Instrument](#) section for more information.

---

*CAUTION: If multiple RI8546 Device Power/Measure TIMs and/or RI8535 Universal Digital TIMs are part of the test system configuration, only one TIM can use the Serial Type button set to 'DUT Defined' in the test plan.*

---

The 'Local' is for RI internal purposes only.

The 'None' selection does not enforce any protocol timing behavior on the **Serial Data** button emits. Use the **Serial Clock Polarity, Serial Strobe Polarity, Serial Clock Period, Serial Direction, Serial Read Size, and Serial Strobe Length** to define the Clock, Data, Read, and Strobe Characteristics.

The 'Read' is for RI internal purposes only.

The 'I2C' selection applies clock and data timing conventions used in the two bidirectional open-drain lines of the I<sup>2</sup>C protocol as well as automatically generating the Start Condition, ACK (Acknowledge) bit, Stop Condition. The bidirectional Serial Data Line or SDA is defined by the **Data** and **Data Read** buttons. This bidirectional pin is created by tying the user-designated Data and Data Read DB resources to pull-

up/pulldown resistors on the Device Interface board or within the fixture.

*NOTE: The Data button must be set to DB2 or DB10, and the DB2/DB10 state button used must be set to 'openCol' to prevent data or logic collisions between the Data and Data Read DB resources.*

The Serial Clock Line or SCL (defined by **Clock** button) must include pull-up resistors on the DB resource selected by the **Clock** button on the Device Interface board or within the fixture. Data writes are set in a test panel using the **I2C Address, I2C Register, I2C Write** buttons found under the I2C Measure Panel of the Static Digital instrument. Bits are captured using the **I2Cbyte** block also found in the I2C Measure Panel of the Static Digital instrument.

*NOTE: The I<sup>2</sup>C standard typically uses +5 V or +3.3 V logic voltages although other voltages are permitted. The design has a 7-bit or a 10-bit (depending on the device used) address space and common I<sup>2</sup>C bus speeds are 100 kbit/s standard mode and 10 kbit/s low-speed mode, but arbitrary clock frequencies are allowed.*

The 'I3C' selection is no longer supported.

The 'SPI' selection will enforce a reduced duty cycle on the designated clock resource of ~30%. This relaxes hold conditions for writing data to the DUT and capturing read data from the DUT.

The 'Generic' selection provides basic serial bit stream capability via the **Serial Data** button. This mode, like the 'generic' mode, is used for arbitrary serial communication. Use the **Serial Clock Polarity**, **Serial Strobe Polarity**, **Serial Clock Period**, **Serial Direction**, **Serial Read Size**, and **Serial Strobe Length** to define the Clock, Data, Read, and Strobe Characteristics.

The 'Generic Read' is for RI internal purposes only.

## Serial Size

Decimal notation-value button that defines the total number of bits in the serial output word and sets the number of clock edges to correspond with the serial size value. If a strobe condition is defined, this button configures the strobe length to comply with the number of bits defined by the **Serial Data** button. A value of zero will default to the automatic read size defaults designated in the various **Serial Type** button value's configuration settings (bit length may vary by type). The maximum value is 1000 bits for a single read/write operation.

Serial Size

0

## Serial Data

Text string input button that defines a bit pattern for the serial data output from the specified data pin to the DUT. The value is input in

Serial Data

binary. A read operation is input as a mask that is logically AND'd with the read bits using an input value of X's for 'don't cares' and 1's for bit reads. Spaces in the input value are ignored. For example, a 16-bit emit consisting of an 8-bit write of CA(hex) followed by a read of 8-bits would be input to the Serial Data button as: 1100101011111111.

*NOTE: If the Serial Auto Init button in the device serial port panel is set to 'off', this button will only function within premeasure and postmeasure button groups.*

## Serial Clock Polarity

Drop down list button that defines the signal polarity of the user-designated clock pin. When the **Serial Type** button is set to 'DUT Defined', this button's setting is overridden by the settings defined by the user for the DUT in the Device Control Editor under the Formats tab.

The 'positive' selection sets the base value of the clock to binary '0' (voltage value of the **Voff** or **Voff Low Byte** buttons). This is typically used when the data is to be captured on the clock's rising edge (low→high transition) and data is propagated on a falling edge (high→low clock transition).

The 'negative' selection selection sets the base value of the clock to binary '1' (voltage value of the **Von** or **Von High Byte** buttons). This is

Serial Clock Polarity

positive

typically used when the data is to be captured on the clock's falling edge (high→low clock transition) and data is propagated on a rising edge (low→high transition).

See [Diagram 2](#) for a timing diagram of clock parameters.

#### Serial Strobe Polarity

positive

### Serial Strobe Polarity

Drop down list button that defines the signal polarity of the user-designated strobe/enable/activation pin with respect to the clock/data. When the **Serial Type** button is set to 'DUT Defined', this button's setting is overridden by the settings defined by the user for the DUT in the Device Control Editor under the Formats tab.

The 'positive' selection sets the base value of the strobe to zero. This is typically used to designate valid data to be captured after the rising edge and during a high value of the strobe pin (low→high transition) of the designated pin and data is invalid after the falling edge (high→low clock transition) and low value of the strobe pin.

The 'negative' selection sets the base value of the strobe to one. This is typically used to designate valid data to be captured after the falling edge (high→low clock transition) and low value of the strobe pin and data is invalid after the rising edge and during a high value of the strobe pin (low→high transition) of the designated pin.

See [Diagram 2](#) for a timing diagram of strobe parameters.

#### Serial Clock Period

20 u

### Serial Clock Period

Decimal notation-value button that sets the period of the serial data rate. For periods less than 10 $\mu$ s (higher than 100 kHz), the fast-mode pins must be used for the data read (DB1/DB9), data (DB2/DB10), and clock pins (DB3/DB11). The maximum clock speed for the fast-mode pins is 1 MHz.

See [Diagram 2](#) for a timing diagram of clock period parameter.

#### Serial Direction

msb first

### Serial Direction

Drop down list button that designates the order the serial bits within a bit stream are emitted. Setting the Serial Type to 'DUT Defined' overrides this buttons setting.

The 'msb first' selection configures the serial data stream to output the most significant bit first from the tester to the DUT.

The 'lsb first' selection configures the serial data stream to output the least significant bit first from the tester to the DUT.



## Serial Auto Init

### Serial Auto Init

on

Drop down list button that provides serial communication initialization. The button is designed to automate the initialization of communication with the DUT when the supply's ( $V_{ON}/V_{OFF}$ ) driving the device bits (DB1..16) are activated in a test panel, section default, or global default. The concept is to set the device under test into a known state. This would be used when the DUT is powered up the first time: Apply rail voltage (typically using DUT Control lines - DPs), power up the communication subsystem (using the Static Digital lines - DBs), and then set the DUT into a known default state. It is also used to reset the part into a default state after a test or measurement without powering down the DUT:  $V_{ON}$  set to 0 V (off) - no clock, DUT registers are now in an unknown state,  $V_{ON}$  set to >0 V (on), the DUT's registers unknown state is invalidated by an automatic serial initialization into a default state defined by the user.

The default 'on' selection will automatically send the default serial initialization conditions to the DUT's serial registers when the voltage level of the Static Digital's supply  $V_{ON}$  exceeds 0 V. This mode is used with the **Serial Type** button set to 'DUT Defined' and the default register parameters are set by the user using the **Active** button within the DUT instrument (see note below).

*NOTE: The default serial state conditions are defined by the user in the Device Control Editor. This creates a 'DUT Instrument' that can be added to the Edit Panel. Within the 'DUT' instrument is a list-select 'State' button with several default states the user can*

*use to define the initialization state of the device under test. Placing this button in a test panel, section default or global default defines the default register conditions sent to the device when a serial auto-initialization event occurs ( $V_{ON}$  is powered up).*

The 'off' selection disables auto-initialization. In this mode, serial register emits using the **Serial Data** and **I2C Write** buttons will only execute within a premeasure/postmeasure group.

### Serial Read Size

0

## Serial Read Size

Decimal notation input button that defines the number of bits to read after a serial emit, corresponding to the number of clock edges from the **Serial Size** value that will be used for the read capture. A value of zero will default to the automatic read size defaults designated in the various **Serial Type** button value's configuration settings (bit length may vary by type). The maximum value is 1000 bits for a single read or write operation.

### Serial Strobe Length

short

## Serial Strobe Length

Drop down list button that defines the strobe length type. When the **Serial Type** button is set to 'DUT Defined', this button is overridden by the settings defined by the user for the DUT in the Device Control

Editor under the Formats tab. This button is used in conjunction with the **Serial Data** and **Serial Clock Polarity** buttons.

The 'short' selection is the default strobe length condition that extends from the first rising or falling (**Serial Clock Polarity** button) edge of the valid data bit stream, to the last rising or falling edge of the valid data bit stream.

The 'long' selection extends the strobe length condition by one clock period beyond the last valid data bit. This mode is typically used with communication that include bus buffers requiring an extra clock cycle to latch the valid data from the buffer into the device's logic. See [Diagram 2](#) for a timing diagram of strobe parameters.



## Meas: SerialData

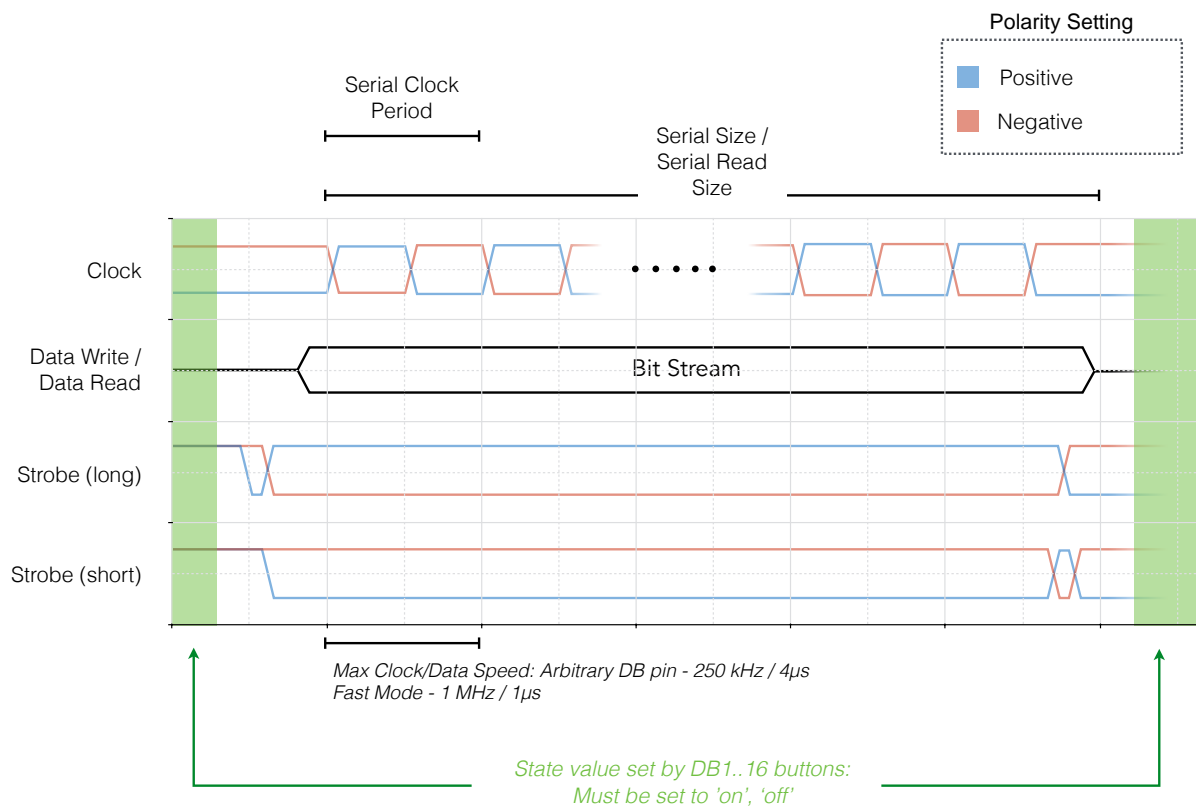
Measurement block that captures a serial data stream and returns the binary values as a float data type value. This block uses the **Serial Read Size** button to define the number of bits to be read from the trailing end of the **Serial Data** value emit. See the [A shift B and C calculation block](#) for manipulating individual bits or bit strings within a serial read capture.

*NOTE: To create a single R/W pin resource, the individual DB resource pins used for the read and write must be physically connected together. The write pin must use DB2*

*or DB10 with the 'openCol' selection and requires the addition of a pull-up/pulldown resistor on DB2/DB11.*

**PANEL: MEASURE**

**DIAGRAM 2 SERIAL DIGITAL SETTINGS & TIMING DIAGRAM**



The above timing diagram shows the behavior of the clock, strobe, and data pins regarding the parameter buttons found in the Device Serial Port pane of the Static Digital Instrument.

**Measure Pin**

None

**Measure Pin**

Drop down list button that defines the data bit pin (DB1..16) that will be connected to the precision current/voltage measurement instrument via the *Monitor* → *DPVP Meas I/V*.

*NOTE: A DB resource pin cannot be driven by a Von/Voff or Von High Byte/Voff High Byte supply and the DPVP Meas I/V in parallel.*

**Sync**

off

**Sync**

Drop down list button that is used to synchronize measurements based on the specified logic condition set. This button is used strictly in a premeasure group that causes the test/measurement start to hold until the button value is true. The maximum wait time is 100 ms.

The 'off' selection is the default state of the button, which enforces no measurement/test synchronization.

The 'Db1High' selection forces the start of a test/measurement in the panel to wait until the logic value on the DB1 pin is above the voltage value specified by the **Von** button.

The 'Db1Low' selection forces the start of a test/measurement in the panel to wait until the logic value on the DB1 pin is below the voltage value specified by the **Voff** button.

The 'Db9High' selection forces the start of a test measurement in the panel to wait until the logic value on the DB9 pin is above the voltage value specified by the **Von** button.

The 'Db9Low' selection forces the start of a test measurement in the panel to wait until the logic value on the DB9 pin is below the voltage value specified by the **Voff** button.

## PANEL: I2C SERIAL

I 2 C Address

11000000

### I2C Address

Data input button that defines the slave address of arbitrary bit length in binary for I<sup>2</sup>C communications using the values '1' and '0' (Spaces are ignored). The IC byte measurement block automatically generates a read by setting the value of the LSB in the I2C Address button to a read bit(logic high).

*NOTE: an ACK bit is automatically generated every eight bits(byte).*

I 2 C Register

10110000

### I2C Register

Data input button that defines the register value in binary of arbitrary length for I<sup>2</sup>C communications using the values '1' and '0' (Spaces are ignored).

*NOTE: an ACK bit is automatically generated every eight bits(byte).*

## I2C Write

Data input button that defines a data write of arbitrary length in binary for I<sup>2</sup>C communications using the values '1' and '0' (Spaces are ignored).

I 2 C Write

11000000

*NOTE: If the Serial Auto Init button in the device serial port panel is set to 'off', then this button will only function within premeasure and postmeasure button groups.*

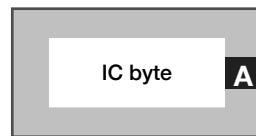
## Meas: IC byte

Measurement block that captures an I<sup>2</sup>C byte/s and returns the binary value as an integer value. This block automatically generates a read bit (logic high bit) in the LSB of the slave address. This measurement block is used with the **Serial Read Size** button to define the number of clock edges for a byte or block(multiple bytes) that follow the slave address defined by the **I2C Address** button. For example, a panel with the **IC byte** measurement block and a **Serial Read Size** button with value 16 would generate the following:

Start Condition, **I2C Address** button value with write bit (logic low), ACK bit, **I2C Register** button value, ACK bit, Start Condition, **I2C**

**Address** button value with read bit (logic high), ACK bit, 16 clock edges defined by the **Serial Read Size** button (with ACK bits between every byte), and then a Stop Condition.

MEAS

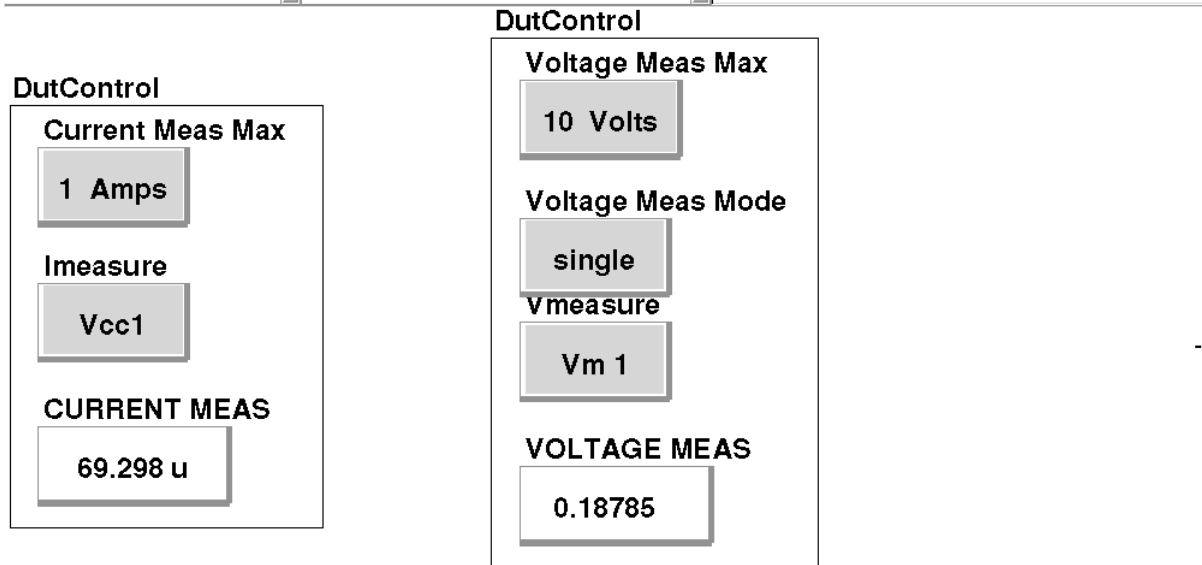
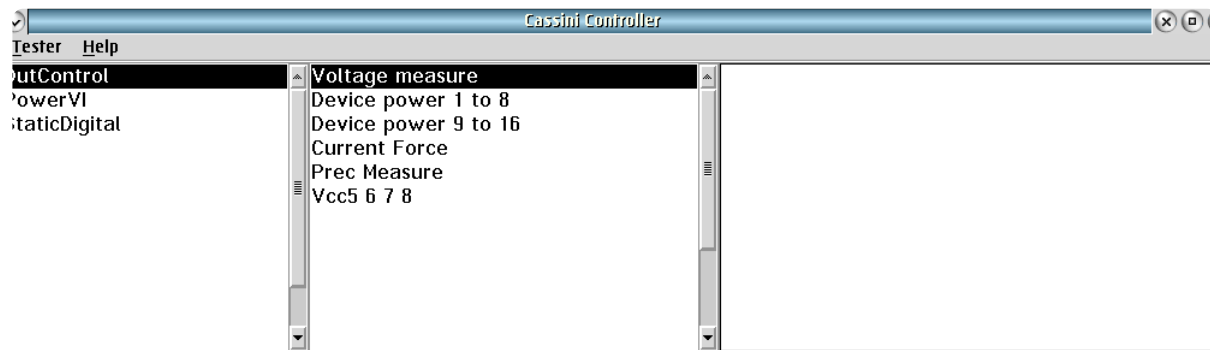




# CONTROL PANELS

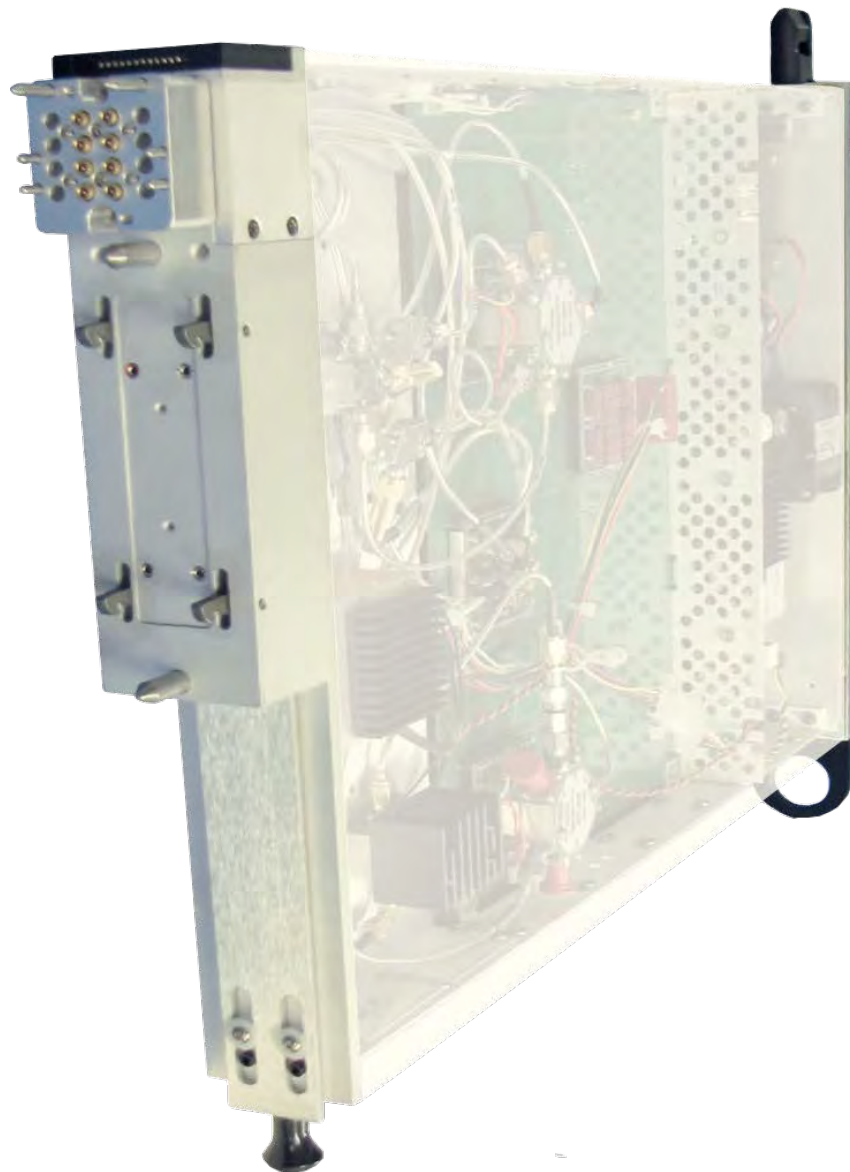
Real-time control of the instruments in this TIM. Only lists buttons not already described in the Edit Panel.

## CONTROL PANELS 5 RI8546 DEVICE POWER



**DUTControl Voltage measure** controls Current and Voltage measurements.

# RI8563: 4GHz TO 40.5GHz TESTSET



## TOPICS

---

[Instruments Provided by this TIM](#)

[Configuration Panels](#)

[Instrument Diagram with Edit Buttons](#)

[Edit Panel Button Descriptions](#)

[Control Panel](#)

Tap the links above to quickly access content

## INSTRUMENTS PROVIDED BY THIS TIM

The instrument in this TIM appear as **Test Head40** in the panel dialog windows.

Model and Name as it appears in the Tester Configuration:

- Test Head40, Ri8563x 4-40.5 GHz Test Set

*NOTE: Multiple RI8563 instruments are enumerated incrementally by the system as “2”, “3”, etc. in the configuration, edit, and control panels (i.e - Test Head40, Test Head402, Test Head403, etc). The “x” in RI8563x denotes the model revision number.*

## CONFIGURATION PANELS

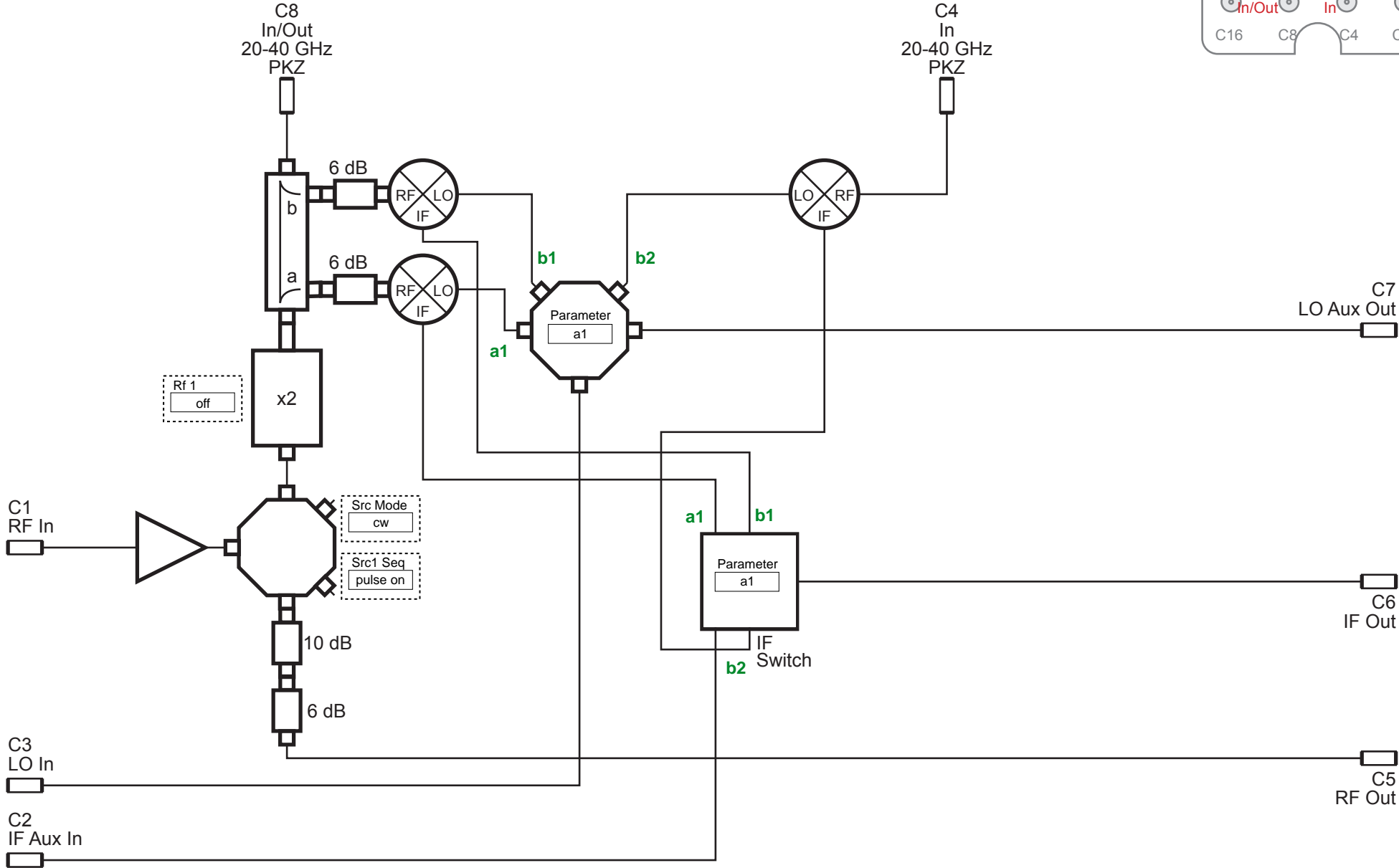
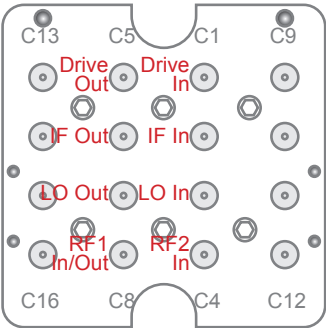
There are two versions of the RI8563 TIM. The RI8563B version also contains a Receiver and does not require and the use of the main system receiver. The Ri8563C streamlined design and requires a system receiver that is connected through the Test Fixture’s interface.

All of the connection path buttons **Lo Input, High Band Input, Lo Band Input, Aux IF Output, Aux RF Output, Second Aux RF Output, External Mixer IF Input #1, 2, and 3, and External Mixer Lo Output #1, 2, and 3** are green as in all the instruments that provide connections to the Test Fixture interface. This means they must be defined by the connections that are listed in the Test Fixture definition, but are still displayed here.

# INSTRUMENT BUTTON DIAGRAM 2.4

The **Rf 1** frequency power settings are controlled by the driving source. For example, if the Source1 TIM is driving the RF In port, then the **Frequency** and **Power** buttons for Source1 will define the

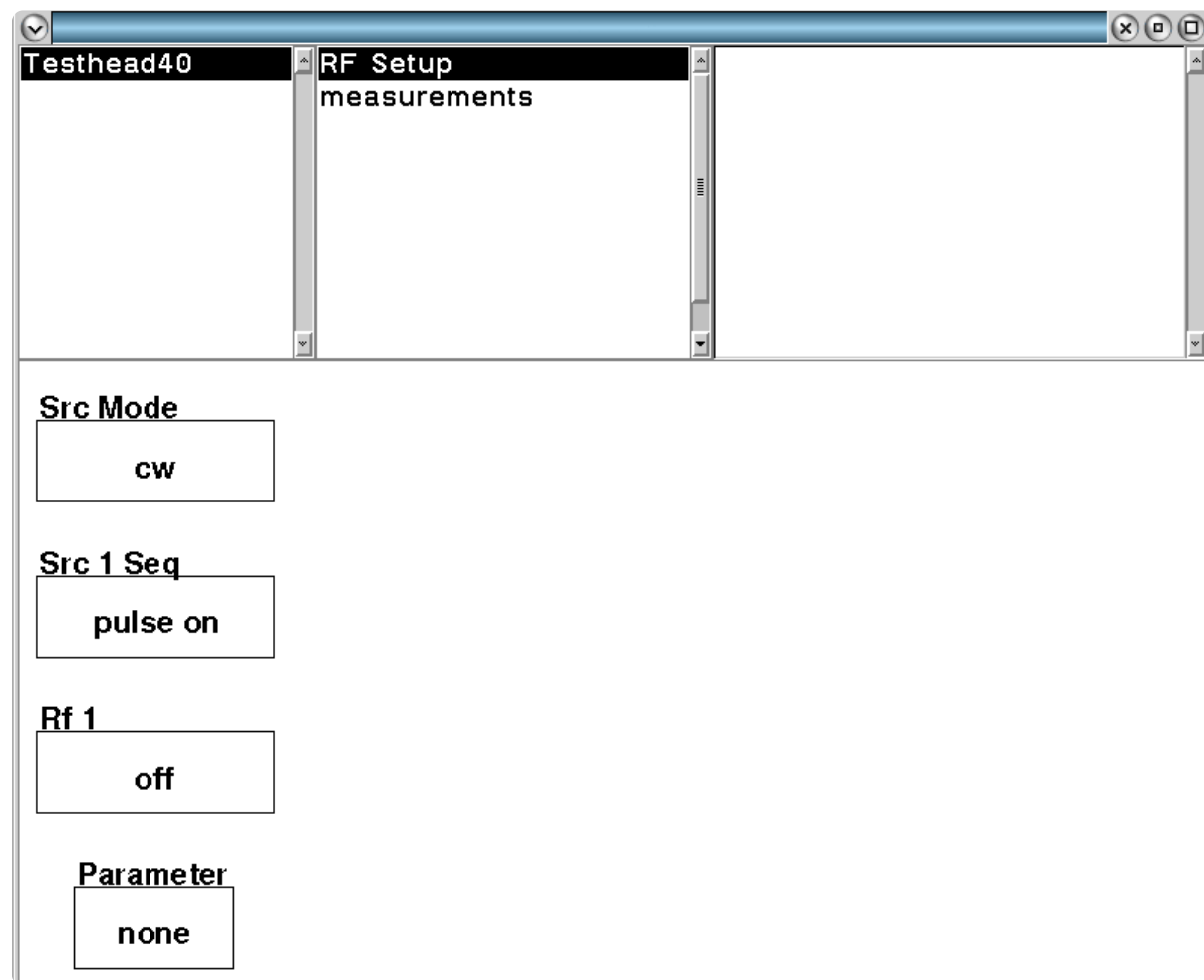
Tap for Zoom View



## EDIT PANELS

The catalog of control buttons for this TIM to be use when building automated Test Programs. These next few panels are common to both the Ri8563B and Ri8563C models.

### EDIT PANELS 7 RI8563 4-40 GHZ TEST SET



Testhead40 RF Setup panel controls RF 1 and Parameter switching of the TIM.

### PANEL: RF SETUP

**The output source frequency and power of the RI8563 are controlled by the driving source Power and Frequency buttons in conjunction with a fixture definition with a connection between the driving source output port and the RI8563's RF In (C1) input ports.**

Src Mode

cw

### Src Mode

A drop down list button that controls a high-speed the source mode of the resource connected to the *RF In (C1)* input port out of the *In/Out 20-40GHz (C8)* output port.

The 'cw' setting is the default mode and provides continuous RF power sourcing.

The 'pulse' setting enables gated RF power sourcing. This mode is used in conjunction with the **Src 1 Seq** button to control the pulse duration.



Src 1 Seq

pulse on

## Src 1 Seq

A drop down list button used in Pre Measure and Post Measure groups to controls RF source pulsing of the resource connected to the *RF In (C1)* input port out of the *In/Out 20-40GHz (C8)* output port. It is used in conjunction with the **Src Mode**: 'pulse' button setting and a **Sequence Delay** button (found in the **System > state** panel of the Editor) to define the duration of the RF pulse.

The 'pulse on' setting starts the RF signal pulse when encountered in the Pre Measure sequence.

The 'pulse off' setting stops the RF signal pulse when encountered in the Pre Measure or Post Measure sequence.

Rf 1

off

## Rf 1

A drop down list button that sets the state of the 8x frequency multiplier in the source path from the *RF In (C1)* input port.

The 'on' selection connects the source path from the *RF In (C1)* port to the microwave multiplier and out of the *In/Out 20-40GHz (C8)* output port.

The 'off' selection disconnects the RF In (*C1*) port source from the 4x frequency multiplier chain.

---

**The measure frequency of the RI8563 is set by the RI8581/RI8587 Receiver TIM's Frequency button in conjunction with a fixture definition defining a connection between one of the Receiver's IF In and LO Out ports and the RI8563's LO In [C3] and IF Out [C6] ports.**

---

Parameter

none

## Parameter

Drop down list button that designates a coupler port that will be routed to the IF switching network for measuring incident/reflected waves and/or computing s-parameters.

The 'none' selection disconnects all IF resources from the downstream receiver chain.

The 'a1' selection routes the down-converted IF signal from the incident signal ( $a_1$  denoted as the 'a' port of the coupler in [Instrument Button Diagram 2.4](#)) of the *In/Out 20-40GHz (C8)* port to the downstream receiver chain.

The 'b1' selection routes the down-converted IF signal from the reflected signal ( $b_1$  denoted as the 'b' port of the coupler in

[Instrument Button Diagram 2.4](#)) of the *In/Out 20-40GHz (C8)* port to the downstream receiver chain.

The 'b2' selection routes the IF signal from the down-converted *In/Out 20-40GHz (C4)* port port (b<sub>2</sub> signal ) to the downstream receiver chain.

**NOTE:**

*a<sub>1</sub> is the incident wave to the input port of the device under test.*

*b<sub>1</sub> is the reflected wave from the input port of the device under test.*

*b<sub>2</sub> is the reflected wave from the output port of the device under test.*

**NOTE:** *The b<sub>2</sub> port measurement is sensitive to mismatch effects because it connects directly to the mixer input port without any attenuation or coupling to control the match.*

## PANEL: MEASUREMENTS

Parameter

std

### Average Mode

A drop down list button that sets the method of averaging used for s-parameter measurements. It is commonly used with the **S11, Thru Measure**, and **S Parameter** measurement blocks.

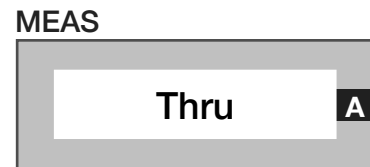
The 'std' (standard) mode measures and averages each individual wave parameter during an s-parameter measurement. The **Averages** button value (found in the **System > state** panel of the Editor) sets the number of samples for the average. For example, a test panel with an **S11** measurement block and **Averages** button value of '4', would measure a<sub>1</sub>, a<sub>1</sub>, a<sub>1</sub>, a<sub>1</sub>, then b<sub>1</sub>, b<sub>1</sub>, b<sub>1</sub>, b<sub>1</sub>.

**NOTE:** *The 'std' is the fastest averaging mode.*

The 'adjacent' mode interleaves the measure of wave parameters during an s-parameter measurement. The **Averages** button value (found in the **System > state** panel of the Editor) sets the number of samples for the average. For example, a test panel with an **S11** measurement block and **Averages** button value of '4', would capture the measurements as a<sub>1</sub>, b<sub>1</sub>, a<sub>1</sub>, b<sub>1</sub>, a<sub>1</sub>, b<sub>1</sub>, a<sub>1</sub>, b<sub>1</sub>.and then average the individual wave parameters. The 'adjacent' averaging mode is

slower than the 'std' mode due to additional signal switching between wave captures, but can minimize memory, temperature and/or signal instability from the DUT during large measurement captures or averages.

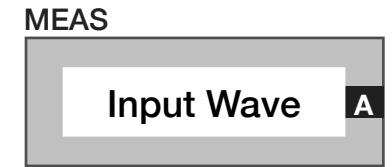
*NOTE: At higher frequencies and with averages greater than 8 to 16, some improvement in accuracy and repeatability are often achieved using the adjacent averaging mode.*



### Meas: Thru

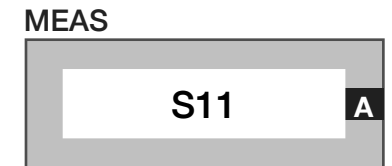
Measurement block that computes the error correction factors for the signal path connecting *In/Out 20-40GHz (C8)* and *In/Out 20-40GHz (C4)* to generate a 'perfect' thru reference from a non-perfect thru standard. The computed error correction factors emulate a perfect thru(lossless) with S11 and S22 terms equal to zero(negative infinity approximated by -180dB), and S21 and S12 equal to one(0dB). The output data type is a complex thru wave format.

*NOTE: This measurement block is typically used as a calibration method to create a perfect thru standard from a generic, non-perfect thru path for relative measurement comparisons.*



### Meas: InputWave

Measurement block that captures the incident and reflected waves as  $a_{11}$  [signal out of *In/Out 20-40GHz (C8)*], measured on the 'a' port of the coupler in [Instrument Button Diagram 2.4](#)) and  $b_{11}$  [signal into *In/Out 20-40GHz (C8)*], measured on the 'b' port of the coupler in [Instrument Button Diagram 2.4](#)). The output data type is two complex voltages for  $a_{11}$  and  $b_{11}$ .



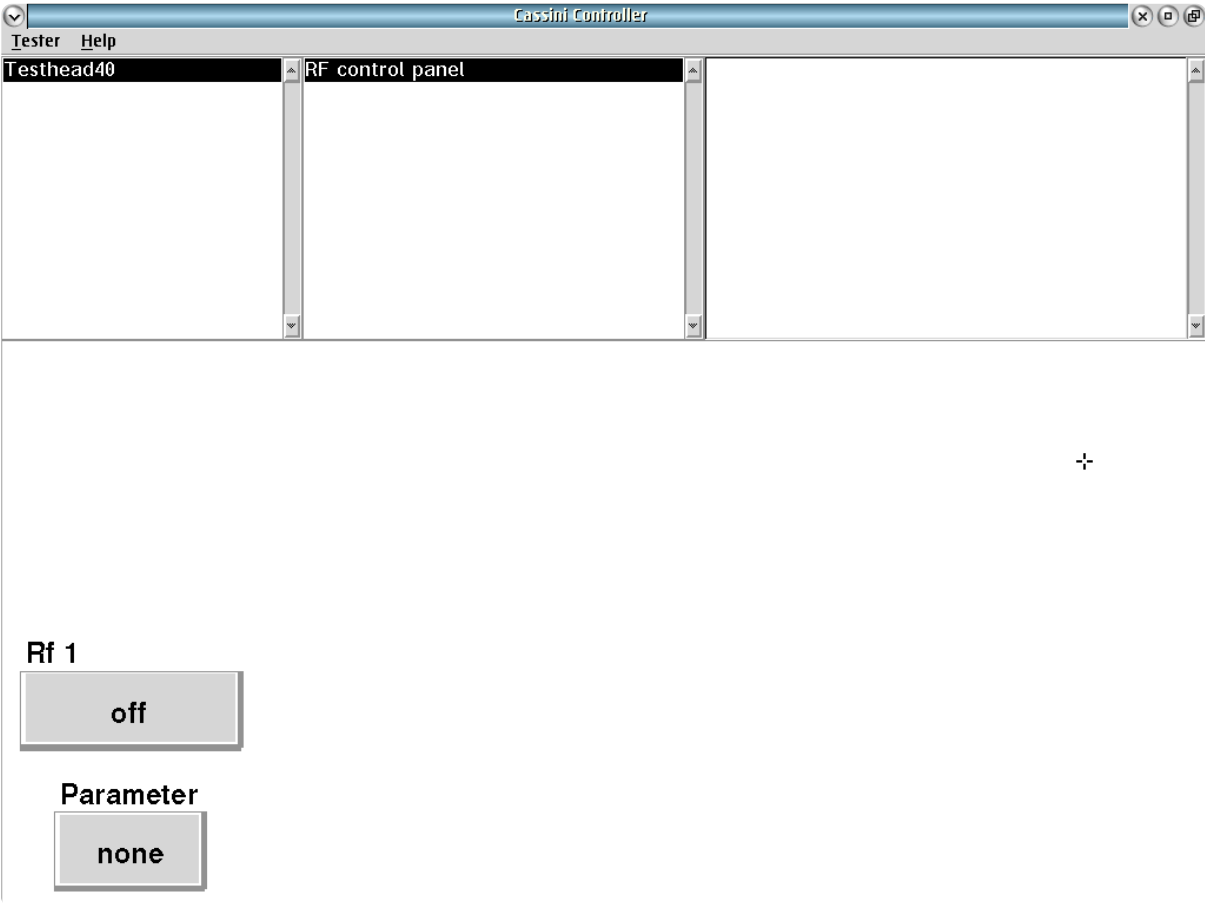
### Meas: S11

Measurement block which performs a series of  $a_1$  and  $b_1$  wave parameter measurements to calculate a vector error-corrected  $S_{11}$  ( $b_1 / a_1$ ) measurement. The output data type is a ratio expressed as a complex voltage.

# CONTROL PANELS

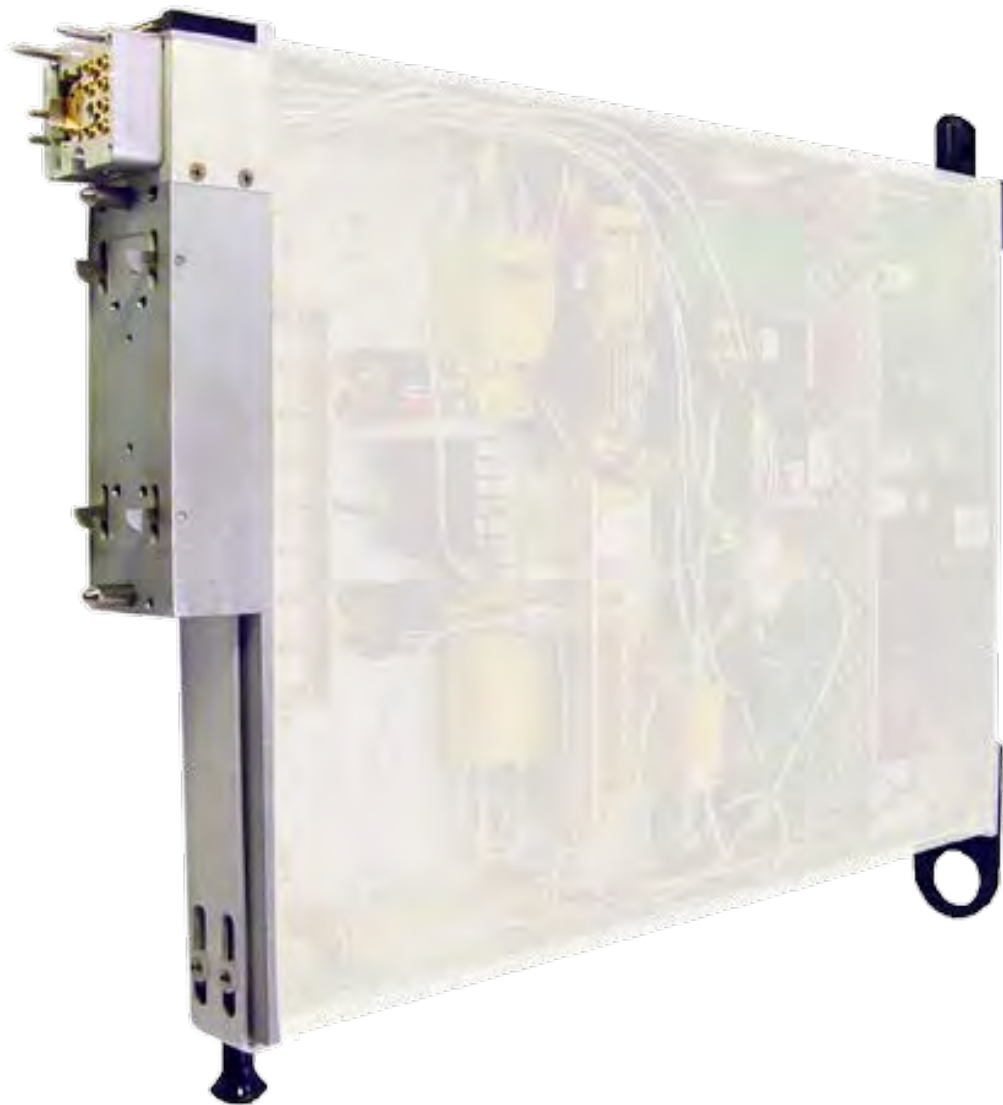
Provides real-time control of the instruments in this TIM. Please refer to the Edit Panels for help with buttons contained in both “Edit” and “Control” panels. RF control panel

## CONTROL PANELS 6 RI8563 4-40 GHZ TEST SET



Testhead40 **RF control panel** provides real time access to switching the 40GHz instrument.

# RI8564: 71GHz TO 86GHz TESTSET



## TOPICS

---

[Instruments Provided by this TIM](#)

[Instrument Diagram with Edit Buttons](#)

[Edit Panel Button Descriptions](#)

[Control Panel](#)

Tap the links above to quickly access content



## INSTRUMENTS PROVIDED BY THIS TIM

The instrument in this TIM appear as **Test Head77** in the panel dialog windows. Model and Name as it appears in the Tester Configuration:

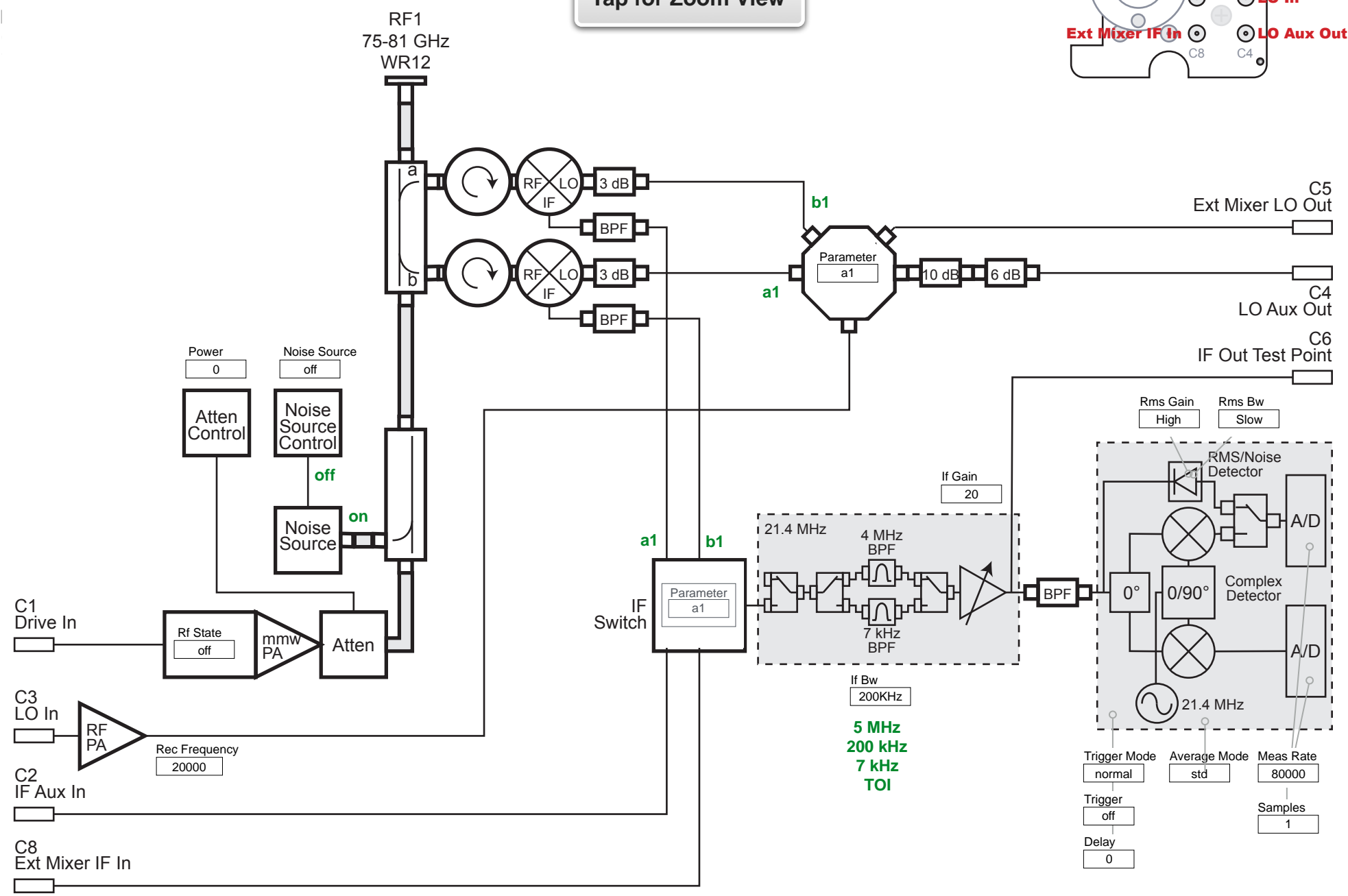
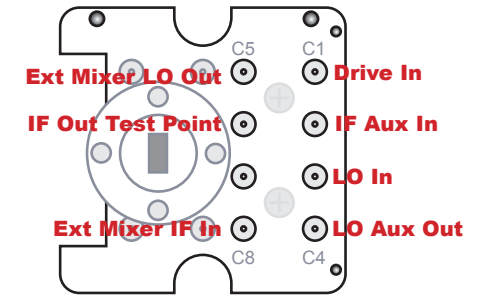
- Test Head77, RI8564x 81 GHz Test Set

*NOTE: Multiple RI8564 instruments are enumerated incrementally by the system as “2”, “3”, etc. in the configuration, edit, and control panels (i.e - Test Head77, Test Head772, Test Head773, etc). The “x” in RI8564x denotes the model revision number.*

INSTRUMENT BUTTON DIAGRAM 2.5: RI8564B VERSION

The **Rf 1** frequency power settings are controlled by the driving source. For example, if the Source1 TIM is driving the **RF In** port, then the **Frequency** and **Power** buttons for Source1 will define the settings.

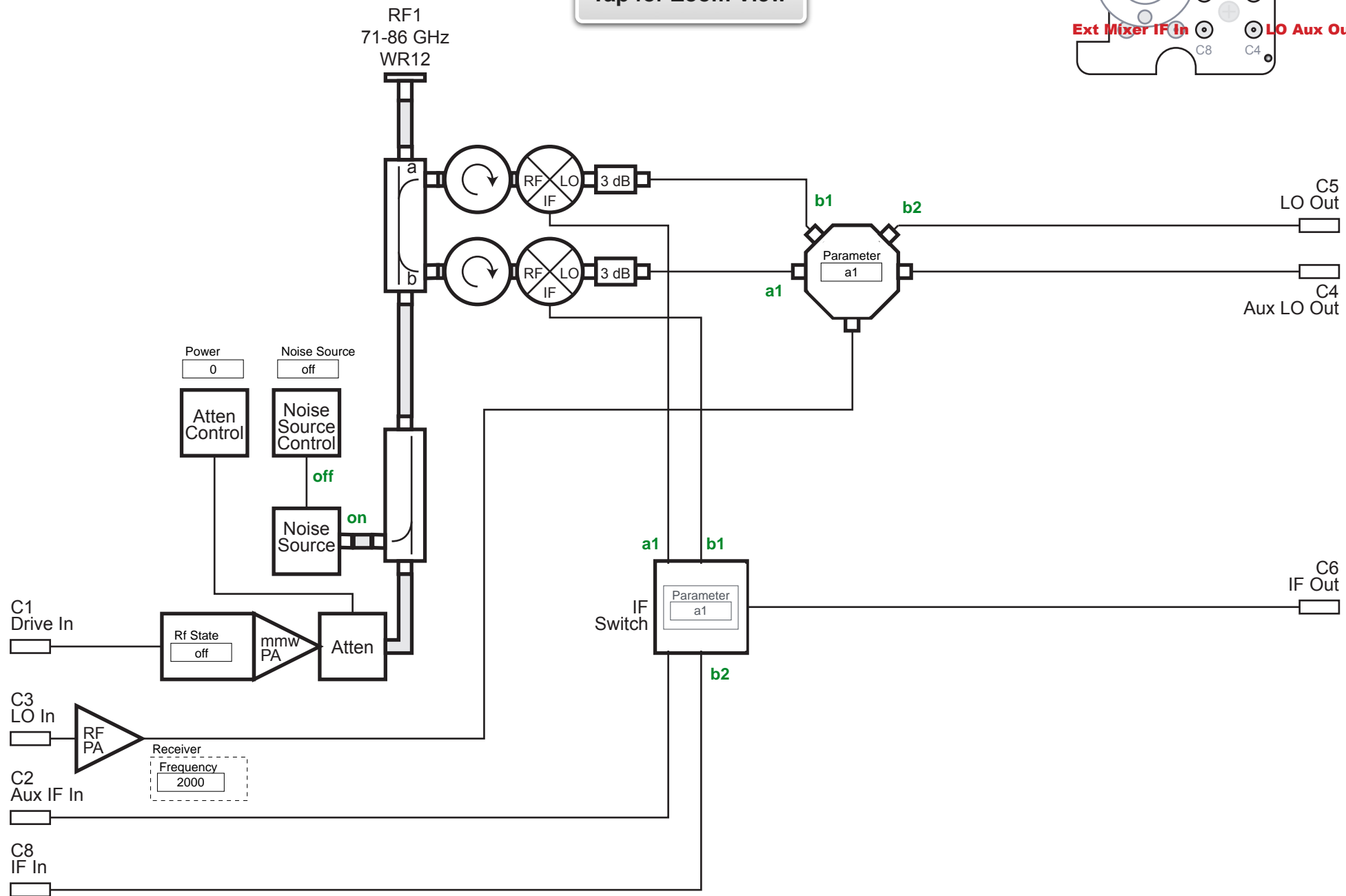
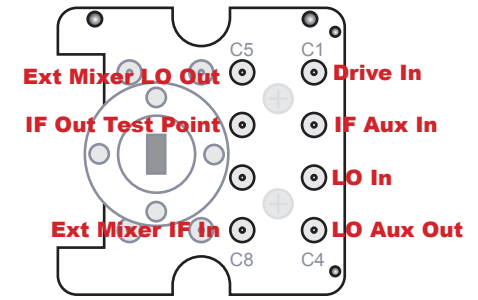
Tap for Zoom View



INSTRUMENT BUTTON DIAGRAM 2.6: RI8564C VERSION

The **Rf 1** frequency power settings are controlled by the driving source. For example, if the Source1 TIM is driving the *RF In* port, then the **Frequency** and **Power** buttons for Source1 will define the settings.

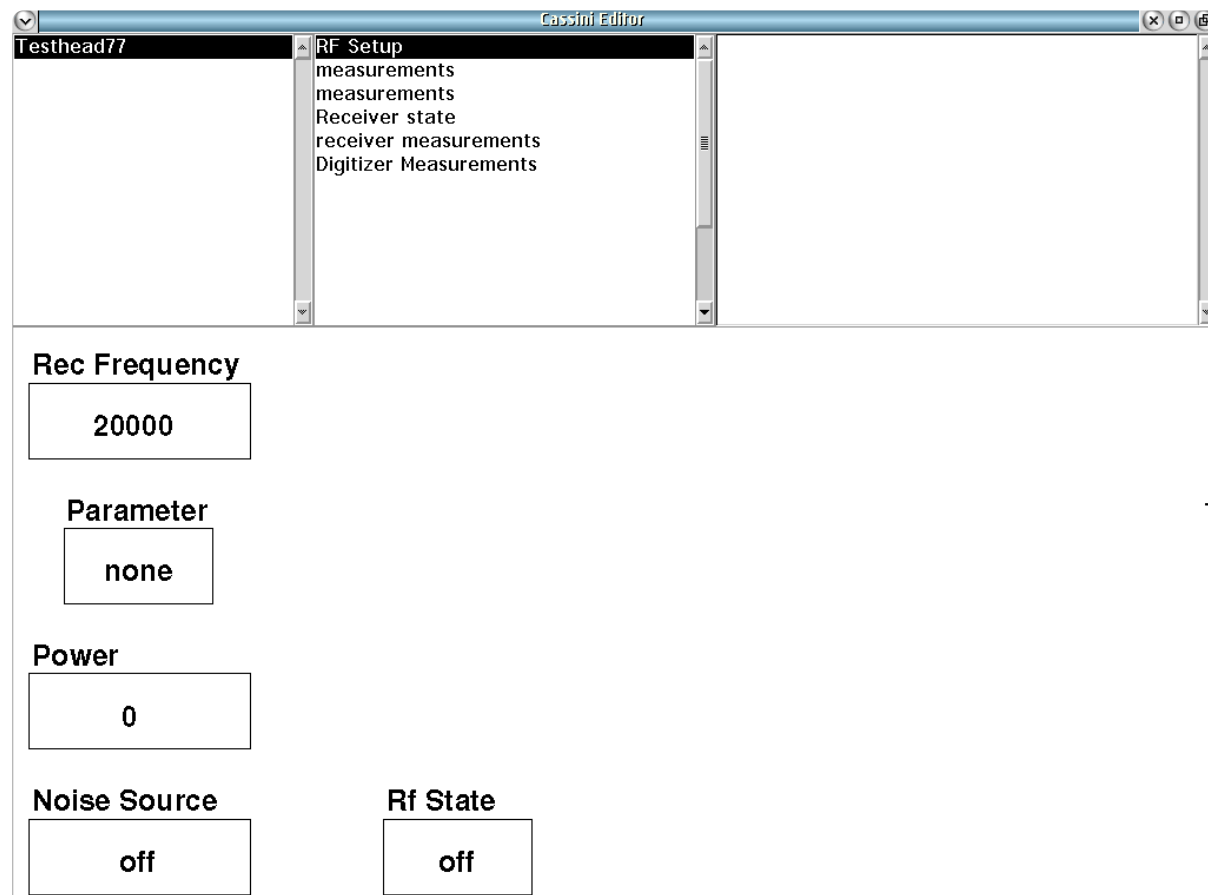
Tap for Zoom View



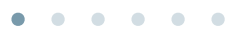
## EDIT PANELS

Automated control of the instruments in this TIM with use by the Test Plan Editor.

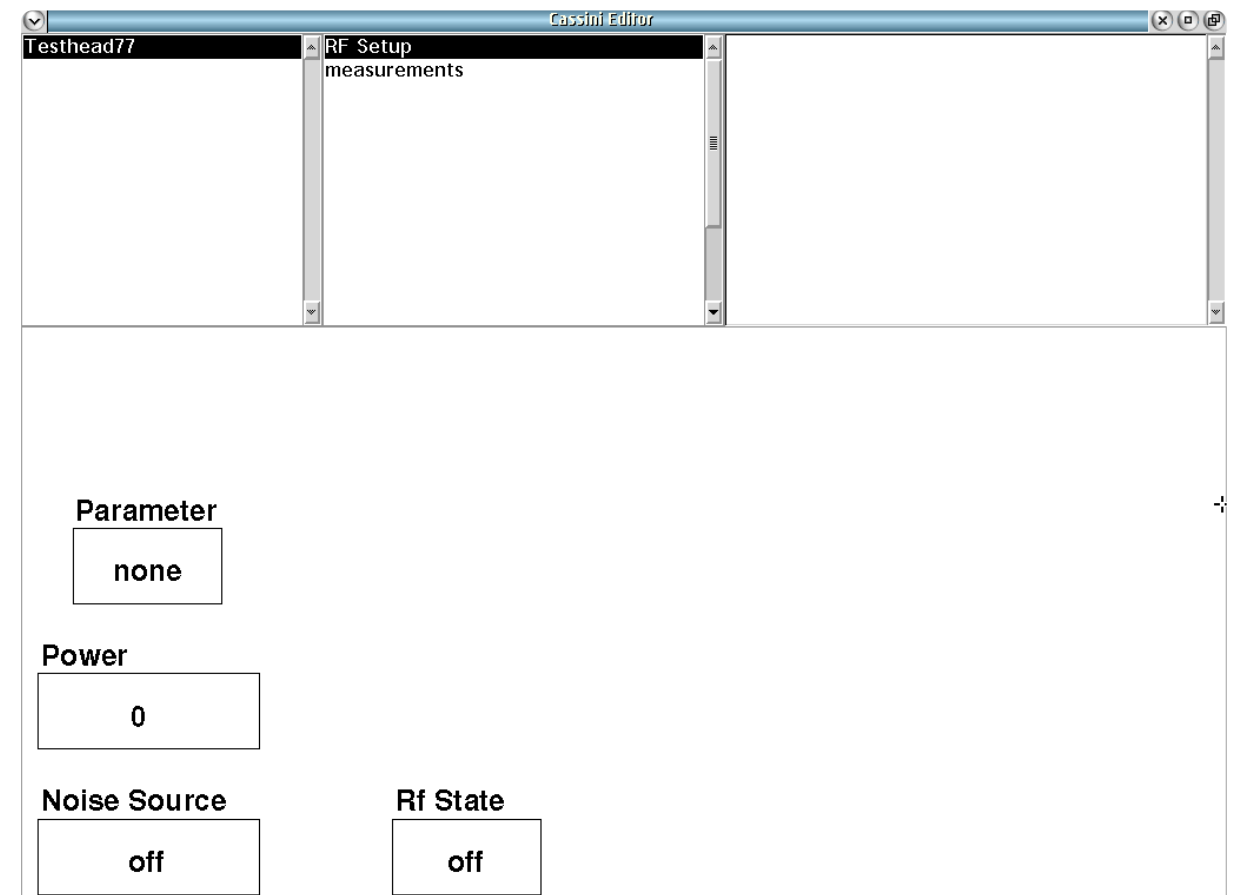
### EDIT PANELS 8 RI8564B: 75-81GHz TEST SET



Testhead77 **RF Setup** panel sets the instrument states for all measurements.



### EDIT PANELS 9 RI8564C: 71-86GHz TEST SET



Testhead77 RF Setup panel sets the instrument states for all measurements.



**PANEL: RF SETUP**

Parameter

none

**Parameter**

Drop down list button that designates the coupler port that will be routed to the internal switching network. This routes the incident/reflected wave signals to the receiver for wave/s-parameter measurements.

The 'none' selection disconnects all IF resources from the downstream receiver chain.

The 'a1' selection configures the internal switches to route the incident signal from coupler arm 'a' ([Instrument Button Diagram 2.5](#) or [Instrument Button Diagram 2.6](#)) to the downstream receiver chain.

The 'b1' selection configures the internal switches to route the coupled arm 'b' ([Instrument Button Diagram 2.5](#) or [Instrument Button Diagram 2.6](#)) to the downstream receiver chain.

The 'b2' selection routes the source connected to the LO In (C3) port out of the LO Out (C5) port to drive an external mixer and routes the *IF In* (C8) down-converted signal from the external mixer to the downstream receiver chain. Reference [Instrument Button Diagram 2.6](#).

The 'Rf4' selection is no longer supported on the RI8564B version.

**NOTE:**

$a_1$  is the incident wave to the input port of the device under test.

$b_1$  is the reflected wave from the input port of the device under test.

$b_2$  is the reflected wave from the output port of the device under test.

Noise Source

off

**Noise Source**

Drop down list button that connects the internal *Noise Source*.

'on' activates the noise source.

'off' deactivates the noise source.

**NOTE:** For noise figure measurements, the source power to Drive In [C1] must be turned off by setting the RI8564 Rf State button 'off'.

Power

0

**Power**

Decimal notation input button that controls the step attenuator in the *Drive In* (C1) path to set the signal power at the *RF1 71-86GHz WR12* output port. Values are input in units of dBm.



The valid input range is -20 to 5 (-20 dBm to +5 dBm). **RI8564B**

The valid input range is -45 to 5 (-45 dBm to +5 dBm). **RI8564C**

---

**The source frequency of the RI8564 is set by the Frequency button of the source connected to the Drive in (C1) input port in conjunction with a fixture definition with a connection between the source's output port and the RI8564's Drive In (C1) ports.**

---

Rec Frequency

20000

## Rec Frequency

Decimal notation input button that sets frequency of the source connected to the *LO In (C3)* port to down convert signals for the internal receiver. The input values are in units of MHz with a valid range of 75000 to 81000 (75GHz to 81GHz).

**(RI8564B only)**

---

**The frequency of the RI8564C is set by the RI8581/RI8587 Receiver TIM's Frequency button in conjunction with a fixture definition defining a connection between one of the Receiver's IF In and LO Out ports and the RI8564C's LO In [C3] and IF Out [C6] ports.**

---

Rf State

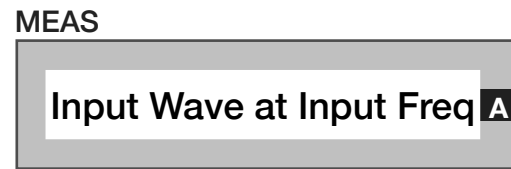
off

## Rf State

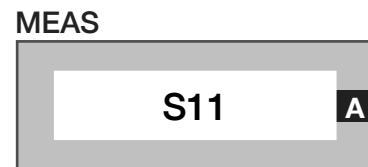
A drop down list button that sets the multiplied RF source signal state.

The 'on' selection connects the source path from the *Drive in (C1)* port to the microwave multiplier and out of the *RF1 71-86GHz WR12* output port.

The 'off' selection disconnects the RF source from the multiplier chain.

**PANEL: MEASUREMENTS****Meas: Input Wave at Input Freq**

Measurement block that captures the incident and reflected waves as  $a_{11}$  (signal out of *W1 71-86GHz* output, measured on the 'a' port of the coupler in [Instrument Button Diagram 2.5](#)) and  $b_{11}$  (signal into *W1 71-86GHz port*, measured on the 'b' port of the coupler in [Instrument Button Diagram 2.5](#)). The output data type is two complex voltages for  $a_{11}$  and  $b_{11}$ . **(RI8564B only)**

**Meas: S11**

Measurement block which performs a series of  $a_1$  and  $b_1$  wave parameter measurements to calculate a vector error-corrected  $S_{11}$  ( $b_1 / a_1$ ) measurement. The output data type is a ratio expressed as a complex voltage.

**Average Mode**

std

**Average Mode**

A drop down list button that sets the method of averaging used for s-parameter measurements. It is commonly used with the **S11, Thru Measure at Input Freq**, and **S Parameter** measurement blocks.

The 'std' (standard) mode measures and averages each individual wave parameter during an s-parameter measurement. The **Averages** button value (found in the **System > state** panel of the Editor) sets the number of samples for the average. For example, a test panel with an **S11** measurement block and **Averages** button value of '4', would measure  $a_1, a_1, a_1, a_1$ , then  $b_1, b_1, b_1, b_1$ .

*NOTE: The 'std' is the fastest averaging mode.*

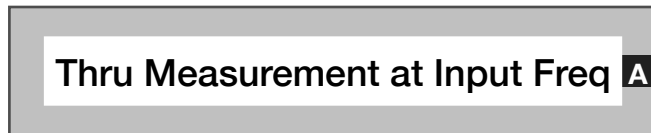
The 'adjacent' mode interleaves the measure of wave parameters during an s-parameter measurement. The **Averages** button value (found in the **System > state** panel of the Editor) sets the number of samples for the average. For example, a test panel with an **S11** measurement block and **Averages** button value of '4', would capture the measurements as  $a_1, b_1, a_1, b_1, a_1, b_1, a_1, b_1$ .and then average the individual wave parameters. The 'adjacent' averaging mode is slower than the 'std' mode due to additional signal switching between wave captures, but can minimize memory, temperature and/or signal

instability from the DUT during large measurement captures or averages.

*NOTE: At higher frequencies and with averages greater than 8 to 16, some improvement in accuracy and repeatability are often achieved using the adjacent averaging mode.*

### Meas: Thru Measurement at Input Freq

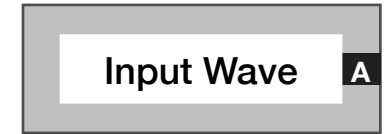
MEAS



Measurement block that computes the error correction factors for the signal path connecting *RF1* and the  $b_2$  downconversion path connected to *IF In (C8)* or *Aux IF In (C2)* to generate a 'perfect' thru reference from a non-perfect thru standard. The computed error correction factors emulate a perfect thru (lossless) with  $S_{11}$  and  $S_{22}$  terms equal to zero (negative infinity approximated by -180dB), and  $S_{21}$  and  $S_{12}$  equal to one (0dB). The resulting data is corrected absolute power, with default units of Watts. **(RI8564C Only)**

*NOTE: This measurement block is typically used as a calibration method to create a perfect thru standard from a generic, non-perfect thru path for relative measurement comparisons.*

MEAS



### Meas: Input Wave

Measurement block that captures the incident and reflected waves as  $a_{11}$  (signal out of *W1 71-86GHz* output, measured on the 'a' port of the coupler in [Instrument Button Diagram 2.6](#)) and  $b_{11}$  (signal into *W1 71-86GHz port*, measured on the 'b' port of the coupler in [Instrument Button Diagram 2.6](#)). The output data type is two complex voltages for  $a_{11}$  and  $b_{11}$ . **(RI8564C Only)**

**PANEL: RECEIVER STATE**

If Bw

200 kHz

**If Bw**

Drop down list select button that sets the internal receiver's analog detection bandwidth within the *IF Board, 21.4 MHz* in the [Instrument Button Diagram 2.5](#).

The '5 MHz' option is the full bandwidth of the receiver's front-end.

The '7 KHz' value is a bandpass filter applied before the IF signal is converted to zero IF/baseband.

The '200 kHz' is a low pass filter applied after IF conversion to zero IF.

The 'TOI' value activates a filtering/gain/attenuator mode that selects the '7 kHz' IF filter and optimizes the ratio of the gain scheme for the amplifiers on the input and output sides of the IF filter to place all of the gain on the output side for high-fidelity third order intercept measurements. In 'TOI' mode the **If Gain** button is limited to values of '8' and '14'. **(RI8564B only)**

*NOTE: The If BW button value is ignored and a 10 MHz IF bandwidth is used when a RMS Power, RMS Power vs. Time, or RMS Voltage measurement block is used in a test panel.*

If Gain

20

**If Gain**

Drop down list select button that sets the gain of an amplifier in units of dB within the *IF Board, 21.4 MHz* in the [Instrument Button Diagram 2.5](#). This value should be optimized for best dynamic range. The selection options of '8', '14', '20', '26', '32', '38', '44', '50', '56', '62', and '68' are in units of dB. **(RI8564B only)**

*NOTE: Optimal settings are achieved by increasing the value until an overflow messages appears in the message window during test compile or run and then selecting the value below the setting that causes an overflow warnings.*

*When used with the If Bw button set to the 'TOI' option, the If Gain setting is the ratio between the input and output amplifiers of the IF filters to place all of the gain on the output side. In this mode, only the '8' and '14' values of the IF gain button are valid.*

If Bw

80000

**Meas Rate**

Decimal notation input button that sets the sample rate of the receiver's digitizer in units of Hz. The maximum sample rate is 200 kHz. **(RI8564B only)**

Rms Bw

Slow

## Rms Bw

Drop down list select button that sets the post-detection bandwidth for Root Mean Squared (RMS) measurements. This button is used to optimize the settling speed of the detectors lock and measure speed. It is commonly used with the **RMS Power**, **RMS Voltage**, and **Delayed RMS Power** measurement blocks. **(RI8564B only)**

*NOTE: The 'Fast' setting can be susceptible to increased measurement instability due to DUT and fixture path dependent settling times.*

An RMS measurement overrides the **If Bw** button and uses a 10 MHz IF bandwidth.

*NOTE: The RMS detector receive path is automatically selected when an RMS Power, RMS Voltage, or Delayed RMS Power measurement block is used.*

Rms Gain

High

## Rms Gain

Drop down list button that sets the post-detection gain. This button is commonly used with the **RMS Power**, **RMS Voltage**, and **Delayed RMS Power** measurement blocks. **(RI8564B only)**

The 'High' setting is approximately 0dB.

The 'Low' setting is approximately -20dB.

*NOTE: The RMS detector receive path is automatically selected when an RMS Power, RMS Voltage, or Delayed RMS Power measurement block is used.*

Samples

1

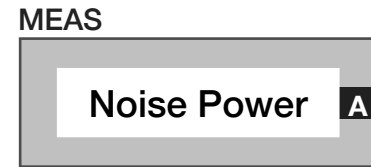
## Samples

Integer value button that sets the number of samples per measurement block. The maximum number of samples is 2000. **(RI8564B only)**

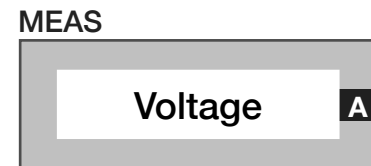


**PANEL: RECEIVER MEASUREMENTS****Meas: Noise Power**

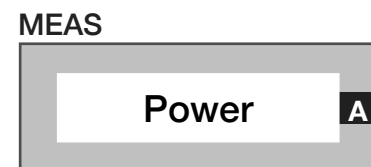
Measurement block that performs a noise power measurement for the current path. **(RI8564B only)**

**Meas: Voltage**

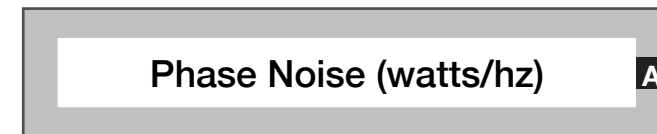
Measurement block that performs a complex voltage measurement for the current path. **(RI8564B only)**

**Meas: Power**

Measurement block that measures error-corrected (calibrated) power for the current path. It converts voltage measurements to power and then averages the result. **(RI8564B only)**

**Meas: Phase Noise (watts/hz)**

MEAS



Measurement block that calculates the noise power within a 1Hz bandwidth using the configured setup. Uses the Noise Power measurement as its base. **(RI8564B only)**

**Meas: Voltage Vs Time**

Measures an RF signal complex voltage amplitude/voltage vector and records the value with its corresponding measurement time. **(RI8564B only)**

MEAS

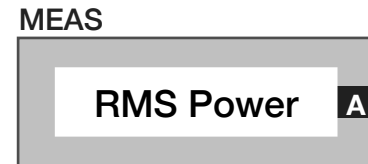
**Meas: RMS Power Vs Time**

Measures RMS power for the selected port using the dedicated RMS/Noise detector path and records the corresponding measurement time. **(RI8564B only)**

MEAS

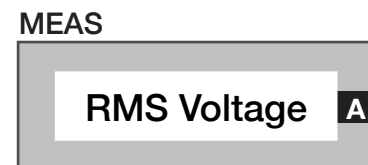


*NOTE: The If BW button value is ignored and a 10 MHz IF bandwidth is used when this measurement block is used in a test panel.*

**Meas: RMS Power**

Measurement block that performs a RMS power measurement for current path using the internal RMS/Noise detector. **(RI8564B only)**

*NOTE: The If BW button value is ignored and a 10 MHz IF bandwidth is used when this measurement block is used in a test panel.*

**Meas: RMS Voltage**

Measurement block measures RMS voltage by converting the complex voltage vector into a scalar amplitude vector and then computes the root mean square value. **(RI8564B only)**

*NOTE: The If BW button value is ignored and a 10 MHz IF bandwidth is used when this measurement block is used in a test panel.*

**PANEL: DIGITIZER MEASUREMENTS**

Trigger

off

**Trigger**

Drop down list button that is used in a pre/post measure groups to activate ('on') or deactivate ('off') triggered receiver measurements. This button is commonly used with the **Delay** button in the pre/post measure group and the **Trigger Mode** button in the test panel or section default. **(RI8564B only)**

Trigger Mode

normal

**Trigger Mode**

Drop down list button that configures the receiver's detector hardware for different trigger/pulse type measurements. This button is commonly used in test panels with the **Trigger** and **Delay** buttons placed in pre/post measure groups. **(RI8564B only)**

The 'normal' selection uses the receiver's voltage detector for triggered measurements.

The 'voltage' selection performs the same function as the 'normal' mode.

The 'power' selection uses the RMS detector for triggered measurements.

The 'V vs T' selection uses the voltage detector for triggered **Voltage vs Time** block measurements.

Delay  
0

## Delay

Decimal notation input button used within pre/post measure groups to delay the start of a triggered measurement with a user-defined duration. The value is in units of seconds with a maximum value of 0.01 seconds and a resolution of 1 $\mu$ s. This button is commonly used with the **Trigger** button. **(RI8564B only)**

MEAS  
Delayed RMS Power A

## Meas: Delayed RMS Power

Measurement block that performs a RMS power calculation after a the time specified in the **Delay** button. **(RI8564B only)**

## Meas: Delayed Voltage

MEAS  
Delayed Voltage A

Measurement block that performs a complex voltage calculation after the time specified in the **Delay** button. **(RI8564B only)**

## Meas: Triggered Digitizer

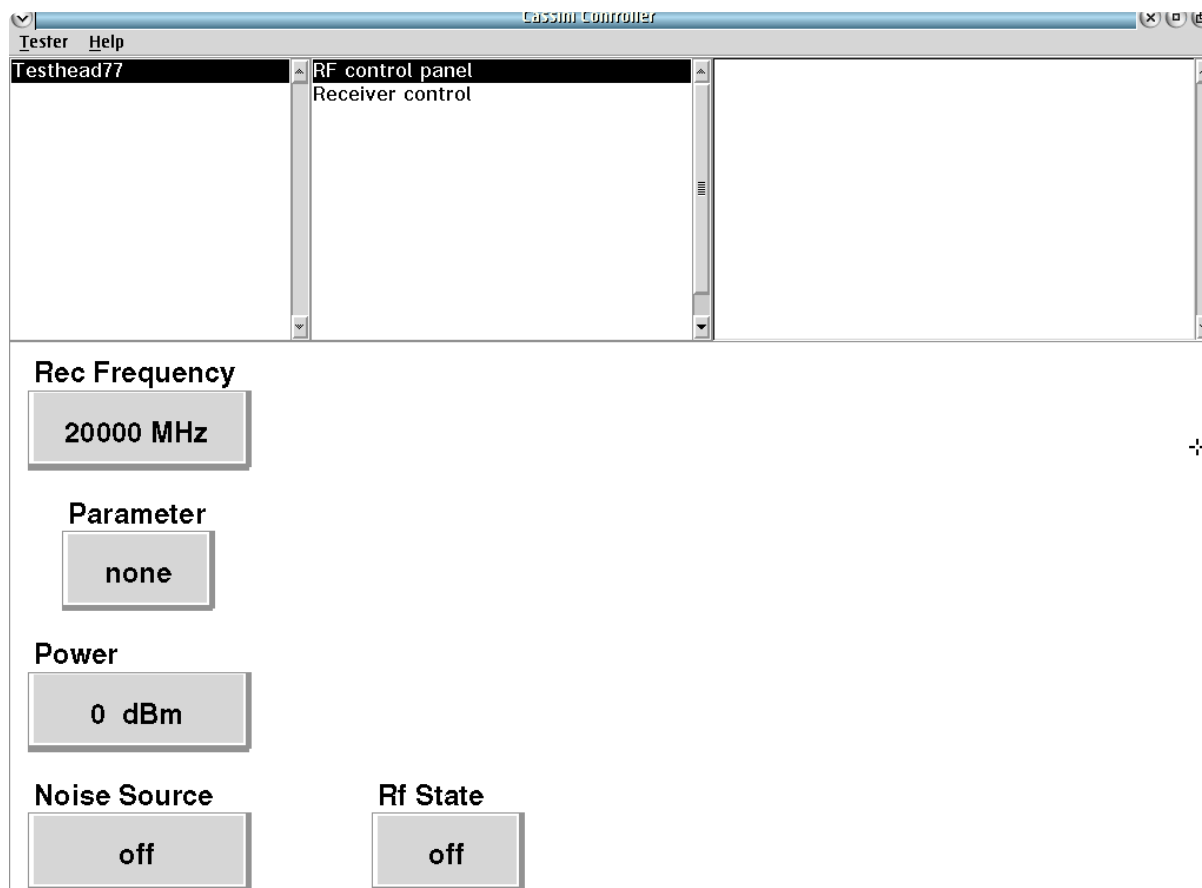
MEAS  
Triggered Digitizer A

Measurement block that performs a complex voltage vs time calculation relative to the specified **Trigger Mode** and **Trigger** buttons in the premeasure group. **(RI8564B only)**

## CONTROL PANELS

Real-time control of the instruments in this TIM.

### CONTROL PANELS 7 RI8564B 75-81GHz TEST SET



**Testhead77 RF control panel** provides real-time control of the switched instruments in this TIM.



## RECEIVER CONTROL

### POWER DBM, VOLTAGE DBM, NOISE DBM/HZ, RMSDBM

The above values are live and refresh when the button is LMB clicked.

# RI8567: 0.01 TO 12GHZ TESTSET



## TOPICS

---

[Instruments Provided by this TIM](#)

[Instrument Diagram with Edit Buttons](#)

[Edit Panel Button Descriptions](#)

[Control Panel](#)

Tap the links above to quickly access content



## INSTRUMENTS PROVIDED BY THIS TIM

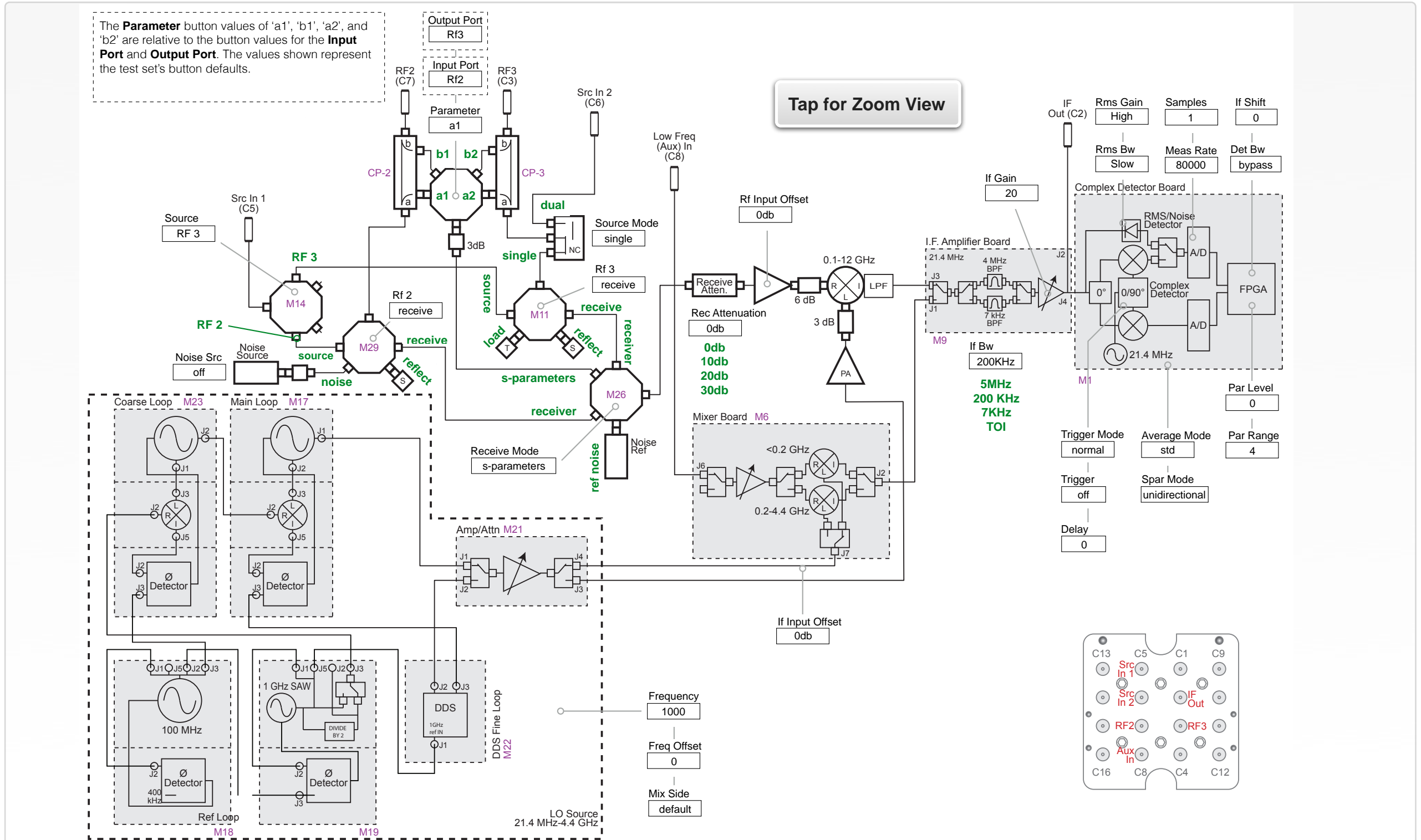
The instrument in this TIM appear as **RFMeasure1** in the panel dialog windows.

Model and Name as it appears in the Tester Configuration:

- RfMeasure1, RI8567x 2 port Testset+Receiver

*NOTE: Multiple RI8567 instruments are enumerated incrementally by the system as “2”, “3”, etc. in the configuration, edit, and control panels (i.e - RFMeasure1, RFMeasure2, RFMeasure3, etc). The “x” in RI8567x denotes the model revision number.*

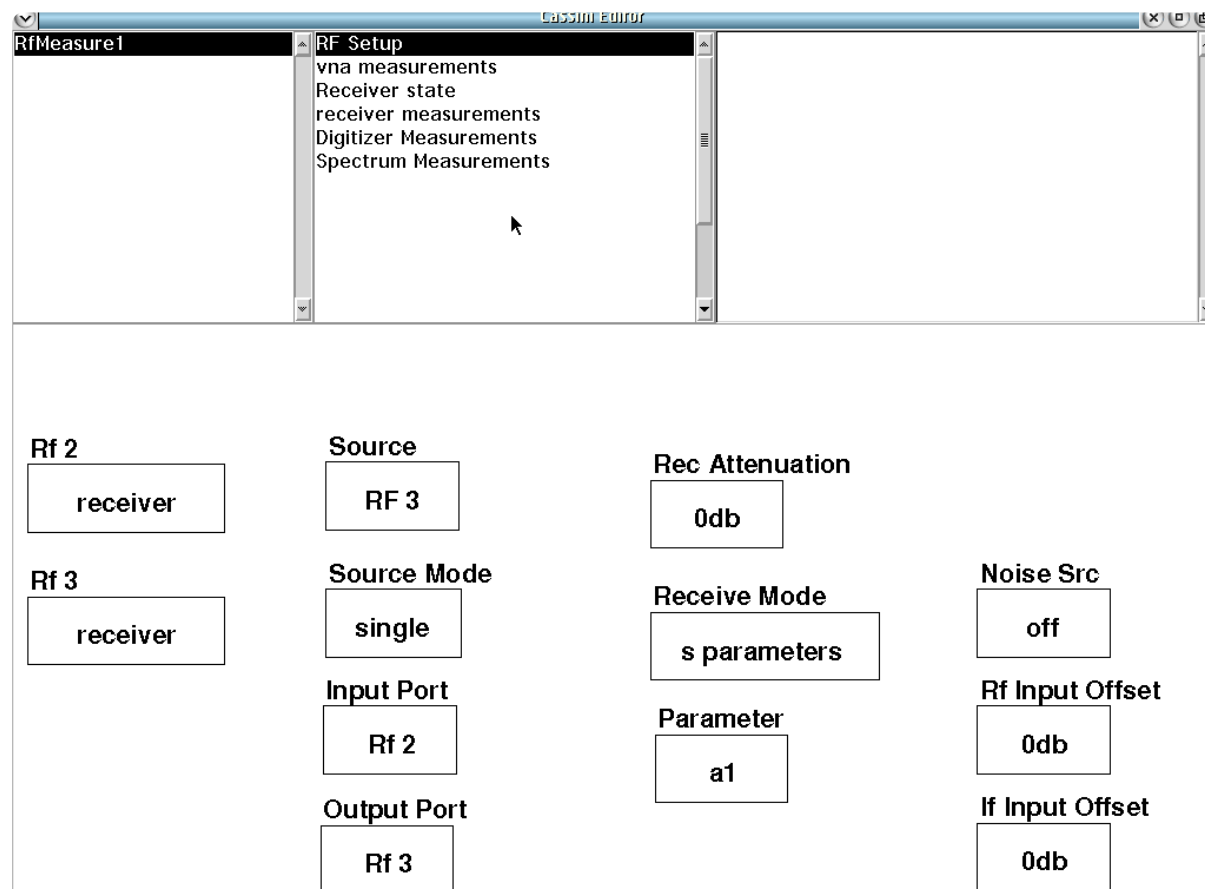
### INSTRUMENT BUTTON DIAGRAM 2.7 RI8567



## EDIT PANELS

Automated control of the instruments in this TIM with use by the Test Plan Editor.

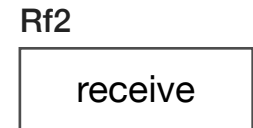
### EDIT PANELS 10 RI8567: 100 KHZ - 12GHZ TEST SET



**RFMeasurement# RF Setup** panel provides switched resource control for instruments in this TIM.



## PANEL: RF SETUP



### Rf 2

Drop down list button that controls the resource connections to the *RF2 (C7)* coupled input/output port. The button configures the *M29* solid-state switch (reference the [Instrument Button Diagram 2.7](#)) to connect *RF2* to various internal resources.

This button in combination with the **Source** and **Receive Mode** buttons set the signal path routing through the TIM's internal mechanical relay connections.

The 'source' selection connects *RF2 (C7)* to the *M14* solid-state switch controlled by the **Source** button for using *RF2 (C7)* as an output port driven by a signal from *Src In 1 (C5)*.

The 'receive' selection connects *RF2 (C7)* to the internal solid-state switch *M26* controlled by **Input Port**, **Output Port**, and **Receive Mode** buttons for using *RF2 (C7)* as an input for s-parameter or direct receiver measurements.

The 'reflect' selection connects *RF2 (C7)* to the internal "short" termination on the *M11* solid-state switch at port position 2.

The 'noise' selection connects *RF2 (C7)* as an output port driven by the noise source at port position 3 on the *M29* solid-state switch.

Rf3

receive

## Rf 3

Drop down list button that controls the resource connections to the *RF3* (C3) coupled input/output port. The button configures the mechanical relay and solid-state switch *M11* (reference the [Instrument Button Diagram 2.7](#)) to connect *RF3* to various internal resources.

This button in combination with the **Source**, **Source Mode**, and **Receive Mode** buttons set the signal path routing through the TIM's internal mechanical relay connections.

The 'source' selection connects *RF3* (C3) to the *M14* solid-state switch controlled by the **Source** button for using *RF3* (C3) as an output port driven by a signal from *Src In 1* (C5).

The 'receive' selection connects *RF3* (C3) to the internal solid-state switch *M26* controlled by **Input Port, Output Port, and Receive Mode buttons** for using *RF3* (C3) as an input for s-parameter or direct receiver measurements.

The 'reflect' selection connects *RF3* (C3) to the internal "short" termination on the *M11* solid-state switch at port position 2.

The 'load' selection connects *RF3* (C3) to the internal 50Ω "load" termination on the *M11* solid-state switch at port position 3.

Source

RF 3

## Source

Drop down list button that controls the solid-state switch *M14* (reference the [Instrument Button Diagram 2.7](#)) for routing the *Src In 1* (C5) resource to the specified port.

The 'RF 2' selection connects *Src In 1* (C5) to switch position 1 of *M14* for routing to *RF2* (C7).

The 'RF 3' selection connects *Src In 1* (C5) to switch position 4 of *M14* for routing to *RF3* (C3).

Source Mode

single

## Source Mode

Drop down list button provides resource routing for *Src In 2* (C6) and *Src In 1* (C5) to *RF3* (C3) by directly controlling the mechanical relay attached to the CP-3 coupler.

The 'single' sets the relay in the "normally closed" position, to connect *Src In 1* (C5) to *RF3* (C3). Use **Rf 3** and **Source** buttons to route signals through to *RF3* (C3).

'dual' sets the relay in the "normally open" position, to connect *Src In 2* (C6) to *RF3* (C3), bypassing the switches controlled by **Rf 3** and **Source** buttons.

## Input Port

This drop down list selection button that designates which of the RF coupled ports *RF2 (C7)*, *RF3 (C3)* will be defined as the input port to the Device Under Test for protocol-aware, s-parameter measurements. This button designates the coupled ports and switch state for the  $a_1$  and  $b_1$  signals for all wave parameter measurements and automates the load condition for forward/incident waves. The **Output Port** and **Receive Mode** buttons are used with the **Input Port** button.

*NOTE: The Input Port value must differ from the Output Port button setting.*

Input Port

Rf 2

## Output Port

This drop down list selection button that designates which of the RF coupled ports *RF2 (C7)*, *RF3 (C3)* will be defined as the output port to the Device Under Test for protocol-aware, s-parameter measurements. This button designates the coupled ports and switch state for the  $a_2$  and  $b_2$  signals for all wave parameter measurements and automates the load condition for forward/incident waves. The

Output Port

Rf 3

**Input Port** and **Receive Mode** buttons are used with the **Output Port** button.

*NOTE: The Input Port value must differ from the Output Port button setting.*

## Rec Attenuation

This drop down list selection button configures the receive attenuator found at the common port output of the *M26* switch (reference the block diagram in the [Appendix](#)). The solid-state attenuator has calibrated attenuation steps of 0 dB, 10 dB, 20 dB, or 30 dB. This button is commonly used in s-parameter and power measurement receive measurements to prevent overdriving/saturating the downstream receiver's RF front-end or optimizing the RF input signal power for best dynamic range with the receiver.

Rec Attenuation

0db

## Receive Mode

This drop down list selection button selects which resource is routed to the internal receiver by directly setting the solid-state switch position of *M26* (reference the block diagram in the [Appendix](#)).

Receive Mode

s-parameters



The ‘s-parameters’ selection connects the receiver to the coupled ports pairs *RF2/RF3* depending on the settings of the **Input Port**, **Output Port** and the **Parameter** buttons. For example, setting **Input Port** to ‘RF2’, **Output Port** to ‘RF3’ and **Parameter** to ‘a1’ would route the incident signal on the CP-2 coupler’s ‘a’ port to the receiver via switch *M26:Position 3*.

‘ref noise’ connects the the internal noise reference located on switch *M26: Position 1* to the receiver.

*NOTE: This noise reference is used as a stable power reference strictly for the instrument’s internal self-check.*

‘receiver’ connects RF2/RF3 as input ports to the receiver via *M26: Position 2* or *M26: Position 4*. This mode is used with the **Rf 2:**‘receiver’ or **Rf 3:**‘receiver’ button settings.

The ‘Aux Input’ routes the *Low Freq (Aux) In (C8)* input port to the receiver. This mode is used for measuring signals from baseband to 4.4GHz with the receiver through the auxiliary port.

Parameter

a1

**Parameter**

Drop down list button that designates which of the coupler ports [CP-2 (RF2), CP-3 (RF3), CP-6 (RF6), CP-7 (RF7)] will be routed to the

switching network. It is typically used for routing incident/reflected wave signals to the receiver for wave/s-parameter measurements.

The a1, ‘b1’, ‘a2’, and ‘b2’ selections use the compiler’s expert system to automatically select the correct switch routing. These selections require an RF port to be set by **Input Port**, **Output Port**, and **Receive Mode:**‘s-parameters’ buttons.

*NOTE:*

*a<sub>1</sub> is the incident wave to the input port of the device under test.*

*b<sub>1</sub> is the reflected wave from the input port of the device under test.*

*a<sub>2</sub> is the incident wave to the output port of the device under test.*

*b<sub>2</sub> is the reflected wave from the output port of the device under test.*

Noise Src

off

**Noise Src**

Drop down list button that controls the state of the internal noise source standard *Noise Source 1*.

The ‘on’ selection powers the noise source, producing an RF calibrated “Hot” noise power.

The ‘Off’ selection deactivates power from the noise diode. This mode can be used for so called “cold” noise power measurements.

*NOTE: The calibration factors for Noise Source 1 are frequency dependent and are selected by the compiler based on the Frequency button definition found in the System instrument of the Edit Panel.*

## Rf Input Offset

This drop down list select button directly controls the receive attenuator and LNA for the receiver. They are located between the last solid state switch M26 and the receiver's mixer (reference the block diagram in the [Appendix](#)). The receive attenuator and LNA allow the user to optimize incoming signal power levels typically to prevent saturation of the receiver's RF mixers. This is useful for compensating for the gain of active device, or losses from passive components for s-parameter/receiver type measurements.

The list options '-30', '-20', '-10', '0', '10', '20', '30' are displayed in units of dB.

*NOTE: Saturation of the downstream RF mixers in the receiver TIM will cause nonlinear behavior in the form of signal harmonics at the downconverter's output and subsequent measurement instability.*

Rf Input Offset

0db

If Input Offset

0db

## If Input Offset

This drop down list select button is a modifier of the **If Gain** button value found in the RI8587 or RI8581 Receiver TIM. It provides relative IF gain modification, i.e **If Gain**: '44' and **If Input Offset**: '-12' would result in an actual IF Gain in the receiver of '32'. This button is typically used to offset output signals from high-gain devices or losses from passive DUTs to maintain consistent signal power into the receiver.

The list options '-12', '-6', '0', '6', '12', '18', '24' are in units of dB.

## PANEL: VNA MEASUREMENTS

Average Mode

std

### Average Mode

A drop down list button that sets the method of averaging used for s-parameter measurements. It is commonly used with the **S11, Thru Measure at Input Freq**, and **S Parameter** measurement blocks.

The 'std' (standard) mode measures and averages each individual wave parameter during an s-parameter measurement. The **Averages** button value (found in the **System > state** panel of the Editor) sets the number of samples for the average. For example, a test panel with an **S11** measurement block and **Averages** button value of '4', would measure  $a_1, a_1, a_1, a_1$ , then  $b_1, b_1, b_1, b_1$ .

*NOTE: The 'std' is the fastest averaging mode.*

The 'adjacent' mode interleaves the measure of wave parameters during an s-parameter measurement. The **Averages** button value (found in the **System > state** panel of the Editor) sets the number of samples for the average. For example, a test panel with an **S11** measurement block and **Averages** button value of '4', would capture the measurements as  $a_1, b_1, a_1, b_1, a_1, b_1, a_1, b_1$ .and then average the individual wave parameters. The 'adjacent' averaging mode is

slower than the 'std' mode due to additional signal switching between wave captures, but can minimize memory, temperature and/or signal instability from the DUT during large measurement captures or averages.

*NOTE: At higher frequencies and with averages greater than 8 to 16, some improvement in accuracy and repeatability are often achieved using the adjacent averaging mode.*

Spar Mode

unidirectional

### Spar Mode

This list select button defines the calculation mode for two-port, vector error-corrected scattering parameters. The mode selection affects the compiler's decisions for load and source routing schemes in the TIM and the subsequent calculation methods for s/wave parameter measurements.

The 'unidirectional' mode computes s-parameters by applying the source to the input of the DUT and using a bi-state, load pull condition on the output port to compute the  $a_1, b_1$ , and  $b_2$  wave parameters. This mode infers the  $a_2$  wave parameter and thus  $S_{22}$ , and is faster than the bidirectional mode. Unidirectional mode is optimal for unilateral active devices (essentially zero reverse transmission coefficient, i.e.  $S_{12}=0$ ) such as power amplifiers.

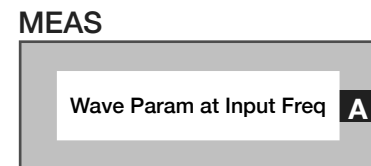
The ‘bidirectional’ mode computes s-parameters using the traditional switched source methodology for measuring all eight transmission parameters and then computing scattering parameters. This selection executes all four source/load conditions on the DUT, providing the most accurate s/wave parameters possible. The bidirectional mode is optimal for passive, low-gain, or low-loss devices.

This button is commonly used with the **Input Port**, **Output Port**, **Parameter**, **Receive Mode**: ‘s-parameter’ and corresponding **Rf 2** and **Rf 3** button designations.

### Meas: Wave Param at Input Freq

Measurement block performs a two-port, error-corrected wave parameter measurement resulting in all 8 transmission parameters:  $a_{11}$ ,  $a_{12}$ ,  $a_{21}$ ,  $a_{22}$ ,  $b_{11}$ ,  $b_{12}$ ,  $b_{21}$ ,  $b_{22}$  for a given device input frequency. It uses the bi-state load pull method with the result in absolute voltage. The receiver’s tuned frequency for this button is defined by the **Freq Reference**, **Input Freq Offset**, and/or **Input Freq Scale** buttons found in the System instrument panel. This block is typically used for user-custom s/wave parameter-like calculations.

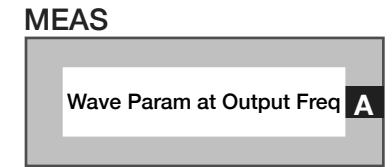
*NOTE: The frequency control button set is typically used for measuring frequency converting devices.*



### Meas: Wave Param at Output Freq

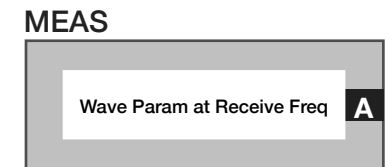
Measurement block performs a two-port, error-corrected wave parameter measurement resulting in all 8 transmission parameters:  $a_{11}$ ,  $a_{12}$ ,  $a_{21}$ ,  $a_{22}$ ,  $b_{11}$ ,  $b_{12}$ ,  $b_{21}$ ,  $b_{22}$  for a given device output frequency. It uses the bi-state load pull method with the result in absolute voltage. The receiver’s tuned frequency for this button is defined by the **Freq Reference**, **Output Freq Offset**, and/or **Out Freq Scale** buttons found in the System instrument panel. This block is typically used for user-custom s/wave parameter-like calculations.

*NOTE: The frequency control button set is typically used for measuring frequency converting devices.*



### Meas: Wave Param at Receive Freq

Measurement block performs a two-port, error-corrected wave parameter measurement resulting in all 8 transmission parameters:  $a_{11}$ ,  $a_{12}$ ,  $a_{21}$ ,  $a_{22}$ ,  $b_{11}$ ,  $b_{12}$ ,  $b_{21}$ ,  $b_{22}$  for a given frequency. It uses the bi-state load pull method with the result in absolute voltage. The receiver’s tuned frequency for this button is defined by the **Frequency**, and/or **Freq Offset** buttons found in the Receiver’s



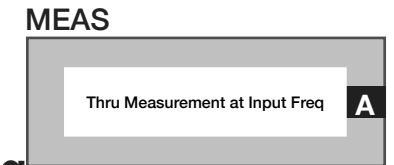
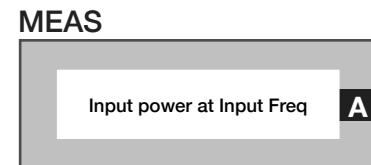
instrument panel. This block is typically used for user-custom s/wave parameter-like calculations.

*NOTE: The phase is only defined within a set and not with any other readings.*

### Meas: Input power at Input Freq

Measurement block performs an error-corrected a11 (forward/incident wave at input with output terminated) measurement with the receiver set to measure at the frequency defined by the **Freq Reference**, **Input Freq Offset**, and/or **Input Freq Scale** buttons found in the System instrument panel. The resulting data is corrected absolute power, with default units of Watts

*NOTE: Units can be changed to dBm using the Convert button found in System > General Calculation panel.*



### Meas: Thru Measurement at Input Freq

Measurement block that computes the error correction factors for the signal path connecting *RF2 (C7)* and *RF3 (C3)* to generate a 'perfect' thru reference from a non-perfect thru standard. The computed error correction factors emulate a perfect thru (lossless) with *S11* and *S22* terms equal to zero (negative infinity approximated by -180dB), and *S21* and *S12* equal to one (0dB). The input frequency is defined by the **Freq Reference**, **Input Freq Offset**, and/or **Input Freq Scale** buttons found in the System instrument panel of the Editor. The resulting data is corrected absolute power, with default units of Watts.

*NOTE: This measurement block is typically used as a calibration method to create a perfect thru standard from a generic, non-perfect thru path for relative measurement comparisons.*



**PANEL: RECEIVER STATE**

Frequency

**Frequency**

Decimal notation input button that sets the tuned frequency of the receiver in MHz. This frequency value is set by the **System Reference** button (found in the 'System' > 'Input Output State' panel of the Editor) when using a virtual instrument such as: VNA, noise figure, or other multi-TIM measurements.

*NOTE: This button is only used for measurements defined by the receiver instrument such as a power or vector voltage measurement.*

Freq Offset

**Freq Offset**

Decimal notation input button that sets the receiver output offset frequency in MHz. Maximum offset range is  $\pm 5$  MHz.

*NOTE: A maximum offset range of  $\pm 10$  MHz is possible within certain frequency ranges. Consult the message window during compile to ensure offset compliance for a given center frequency.*

Mix Side

**Mix Side**

Drop down list select button that selects the 'High' (upper) or 'Low' (lower) sideband of the down-converted signal image to be digitized by the receiver. The 'default' value allows the compiler to select the optimal value.

*NOTE: Changing from the default setting can affect tester accuracy. The 'high' or 'low' button settings should only be used if there is spurious or undesirable spectral content from the device under test in the default sideband which interferes with the measurement. For best accuracy, the 'default' setting should be used.*

If Gain

**If Gain**

Drop down list select button that sets the gain of an amplifier in units of dB within the "IF Board, 21.4MHz" shown in the block diagram. This value should be optimized for best dynamic range. The selection options of '8', '14', '20', '26', '32', '38', '44', '50', '56', '62', and '68' are in units of dB.

*NOTE: Optimal settings are achieved by increasing the value until an overflow messages appears in the message window during test compile or run and then selecting the value below the setting that causes an overflow warnings.*

If Bw

200 kHz

**If Bw**

Drop down list select button that sets the receiver's analog detection bandwidth within the "IF Board, 21.4MHz" in the block diagram. The '5MHz' option is the full bandwidth of the receiver's front-end.

The '7kHz' value is a bandpass filter applied before the IF signal is converted to zero IF/baseband.

The '200 kHz' is a low pass filter applied after IF conversion to zero IF.

The 'TOI' value activates a filtering/gain/attenuator mode that selects the '7kHz' IF filter and optimizes the IF and baseband gain/attenuator scheme for third order intercept measurements. In 'TOI' mode the **If Gain** button is limited to values of '8' and '14'.

*NOTE: The button value is ignored and a 10 MHz bandwidth is used when an RMS Power, Computed RMS, or RMS Power vs. Time measurement block is used in a test panel.*

Samples

1

**Samples**

Decimal notation input button that sets the total number of measurement samples.

Meas Rate

80000

**Meas Rate**

Decimal notation input button that sets the sample rate of the receiver's digitizer in units of Hz. The maximum sample rate is 200 kHz.

Rms Bw

slow

**Rms Bw**

Drop down list select button that sets the post-detection bandwidth when an **RMS Power**, **Computed RMS**, or **RMS Power vs. Time** measurement block is used. This button is used to optimize the settling speed of the detectors lock and measure speed.

*NOTE: The 'Fast' option setting can be susceptible to increased measurement instability due to DUT and fixture path dependent settling times.*

*NOTE: The RMS detector receive path is automatically selected when an RMS Power, RMS Voltage, or RMS PowerVsTime measurement block is used.*

Rms Gain

High

## Rms Gain

Drop down list button that sets the post-detection gain.

'High' is approximately 0dB.

'Low' is approximately -20dB.

## PANEL: RECEIVER MEASUREMENTS

MEAS

Computed RMS **A**

### Meas: Computed RMS

Measurement block computes an RF signals RMS power using the complex voltage detector in the receiver.

*NOTE: The If BW button value is ignored and a 10 MHz IF bandwidth is selected when this measurement block is used in a test panel.*

MEAS

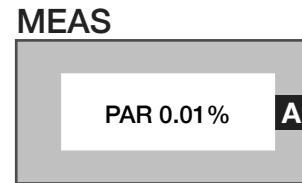
CCDF **A**

### Meas: CCDF

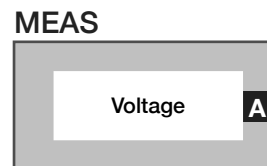
This measure block computes the Complex Cumulative Distribution Function (CCDF). Measure the CCDF at the given Par Level measureRate and samples. Result is ratio of samples above the PAR level to total samples

**Meas: PAR 0.01%**

Measures and compute the power of the Peak to Average Ratio at 0.01%. It is used in conjunction with the **Par Level** and **Par Range** buttons and commonly used with the **Averages** and **Samples** buttons to determine the average power and number of sample points to use for peak detection respectively.

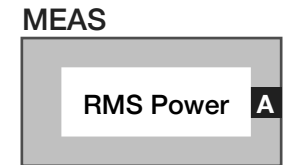
**Meas: Voltage**

Measures the RF signal's complex voltage amplitude for the selected port. The input signal is mixed with the receiver's orthogonal tuning signals, providing input signal phase and amplitude represented as a complex voltage value or voltage vector. It is commonly used with the **Average** button found in the **System > state** panel of an Editor.

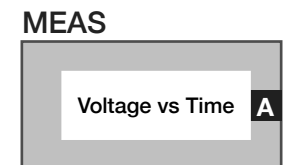
**Meas: RMS Power**

Measurement block that computes the RMS power for the selected port using the RMS/Noise detector. The **Rf 2**: 'receive' and/or **Rf 3**: 'receive' buttons settings are used to select the measurement port for this block.

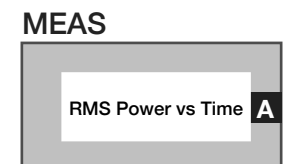
*NOTE: The If BW button value is ignored and a 10 MHz IF bandwidth is selected when this measurement block is used in a test panel.*

**Meas: Voltage vs Time**

Measures an RF signal complex voltage amplitude/voltage vector and records the value with it's corresponding measurement time.

**Meas: RMS Power vs Time**

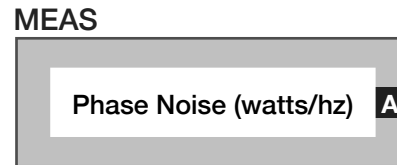
Measures RMS power for the selected port using the dedicated RMS/Noise detector path and records the corresponding measurement time.



*NOTE: The If BW button value is ignored and a 10 MHz IF bandwidth is selected when this measurement block is used in a test panel.*

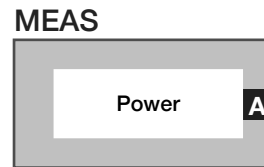
### Meas: Phase Noise (watts/hz)

Measure the noise power in units of Watts/Hz in a 1 Hz bandwidth with the user-defined setup. Uses the Noise Power measurement as its base.



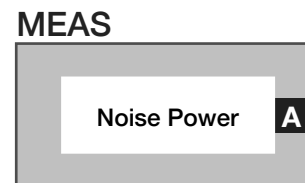
### Meas: Power

Measures the corrected signal power for the selected port and path. The block converts complex voltage to a scalar power value.



### Meas: Noise Power

Measurement block measures noise power for a selected port using the dedicated noise detector in the receiver's baseband subsystem.



Par Level

### Par Level

Decimal notation input button that defines the expected peak or maximum power level of the stimulus signal in dBm. This button is used with the **Par Range** button and **PAR 0.01%** and **CCDF** measurement blocks.

Par Range

### Par Range

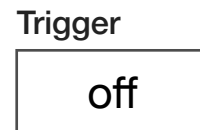
Decimal notation input button that defines the power level range in dBm below the **Par Level** button setting that will be divided into 8 power step measurement levels when measuring the signal power levels for PAR or CCDF of a stimulus signal. The **Par Level** and **Par Range** buttons combine to define the measurement dynamic range and power step size, i.e - a **Par Level** value of '0' and Par Range value of '4' defines an expected peak signal power of 0dBm with a measurement resolution of 0.5dB/step size (4dBm/8 steps) below the expected peak power. This button is used with the **PAR 0.01%** and **CCDF** measurement blocks.



## PANEL: DIGITIZER MEASUREMENTS

### Trigger

Drop down list button that is used in a pre/post measure groups to activate ('on') or deactivate ('off') triggered receiver measurements. This button is commonly used with the **Delay** button in the pre/post measure group and the **Trigger Mode** button in the test panel or section default.

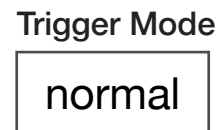


### Trigger Mode

Drop down list button that configures the receiver's detector hardware for different trigger/pulse type measurements. This button is commonly used in test panels with the **Trigger** and **Delay** buttons placed in pre/post measure groups.

The 'normal' selection uses the receiver's voltage detector for triggered measurements.

The 'voltage' selection performs the same function as the 'normal' mode.

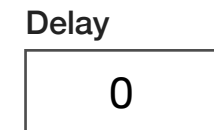


The 'power' selection uses the RMS detector for triggered measurements.

The 'V vs T' selection uses the voltage detector for triggered **Voltage vs Time** block measurements.

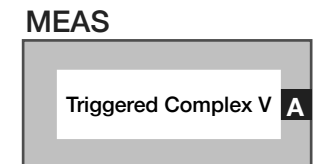
### Delay

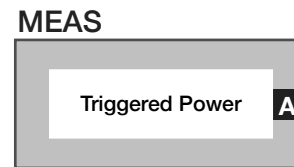
Decimal notation input button used within pre/post measure groups to delay the start of a triggered measurement with a user-defined duration. The value is in units of seconds with a maximum value of 0.01 seconds and a resolution of 1 $\mu$ s. This button is commonly used with the **Trigger** button.



### Meas: Triggered Complex V

Measurement block that calculates an RF signals complex voltage vector vs. time relative to a specified trigger in the premeasure. This measurement block is commonly used with the **Trigger**, **Trigger Mode**, and/or **Delay** buttons.





## Meas: Triggered Power

Measurement block computes RF signal power vs. time from measured complex voltage relative to a specified trigger in the premeasure. This measurement block is commonly used with the **Trigger**, **Trigger Mode**, and/or **Delay** buttons.

## PANEL: SPECTRUM MEASUREMENTS

If Shift

0

### If Shift

Decimal notation input button that sets the frequency offset for the FPGA-based mixer within the digital signal processor subsystem. Values are in units of Hz with a range of 0 to 100 kHz.

Det Bw

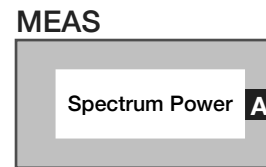
bypass

### Det Bw

Drop down list button that configures the bandwidth of a post-measure, low-pass digital filter in the receive detector's FPGA-based DSP chain. These provide selectable, narrow-band filters with typically 60 dB of stop band attenuation. The 'bypass' selection is the default, applying no digital filter. The other options are 3 MHz, 2 MHz, 1 MHz, 500 kHz, 200 kHz, 100 kHz, 50 kHz, 25k Hz, 10k Hz, 5k Hz, 2.5 kHz, and 1 kHz bandwidth filters.

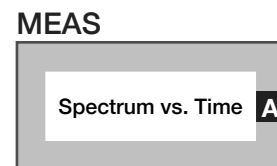
### Meas: Spectrum Power

Measurement block computes the spectral power in units of Watts/Hz using the receiver's FPGA-based, real-time DSP.



### Meas: Spectrum Voltage

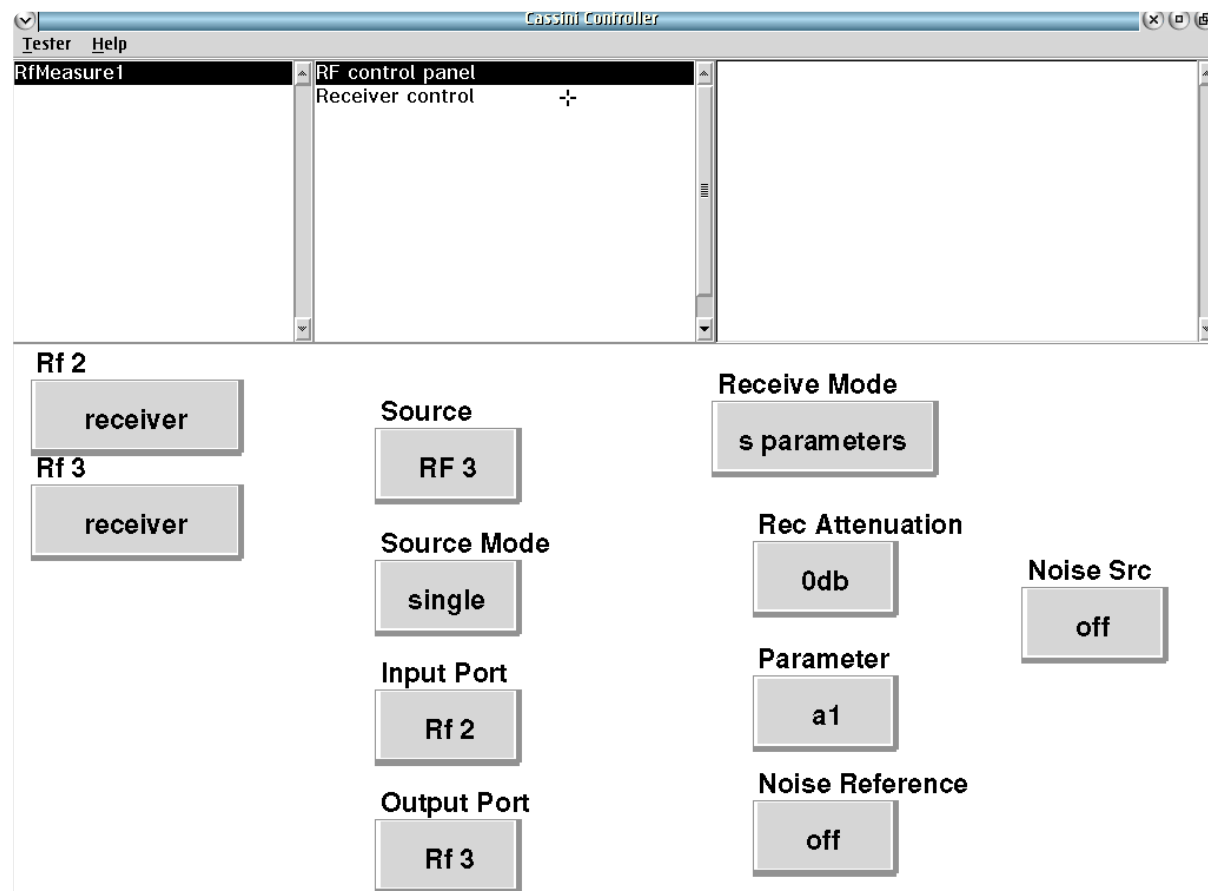
Measurement block computes spectral voltage vectors (complex voltage) versus time using the receiver's FPGA-based, real-time DSP.



# CONTROL PANELS

Real-time control of the instruments in this TIM.

## CONTROL PANELS 8 RI8567: 100 kHz - 12GHz TEST SET



RfMeasure# **Rf control panel** controls the states of the receiver in real time.

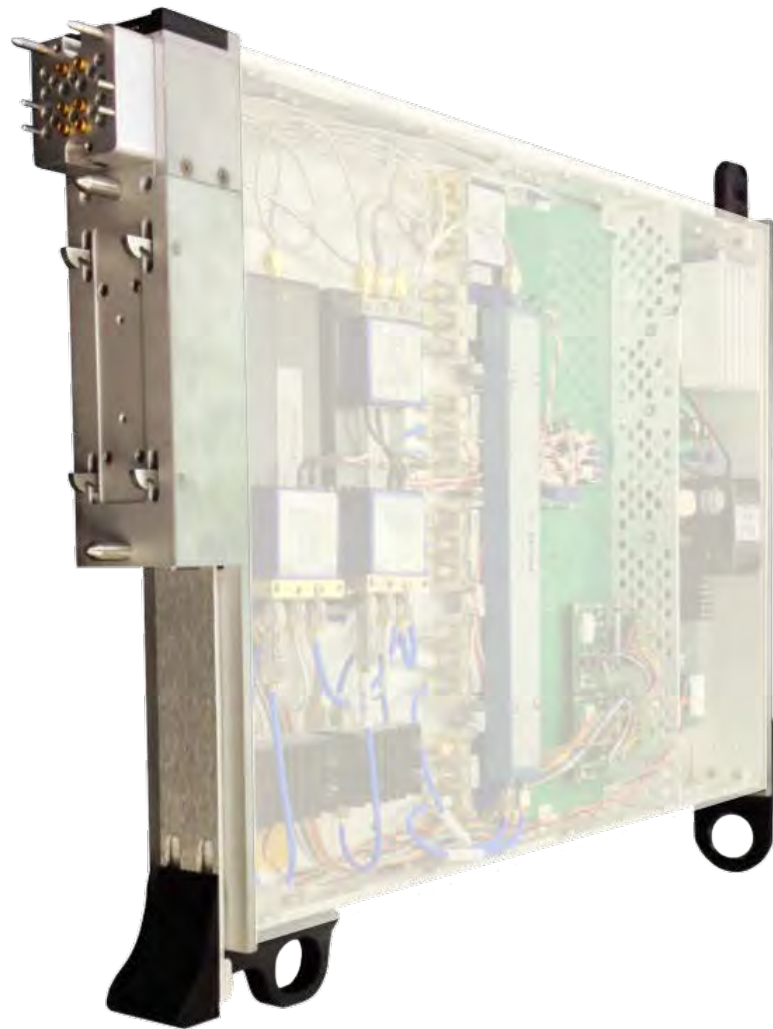


## RECEIVER CONTROL PANEL

### POWER DBM, VOLTAGE DBM, NOISE DBM/HZ, RMS DBM, Path Gain

All above measurements are refreshed in real-time when clicked.

# RI8572: WAVEFORM GENERATOR & MEASURE



## TOPICS

---

[Instruments Provided by this TIM](#)

[Configuration Panel](#)

[Instrument Diagram with Edit Buttons](#)

[Edit Panel Button Descriptions](#)

[Control Panel](#)

Tap the links above to quickly access content



## INSTRUMENTS PROVIDED BY THIS TIM

The instrument in this TIM appear as **Oscilloscope**, **SineGen**, and **Waveform** in the panel dialog windows.

Model and Name as it appears in the Tester Configuration:

- Oscilloscope, RI74105x Hi Spd scope/counter/BER
- SineGen, Ri7403x Dual Sine Source
- Waveform, Ri74211x Complex Waveform

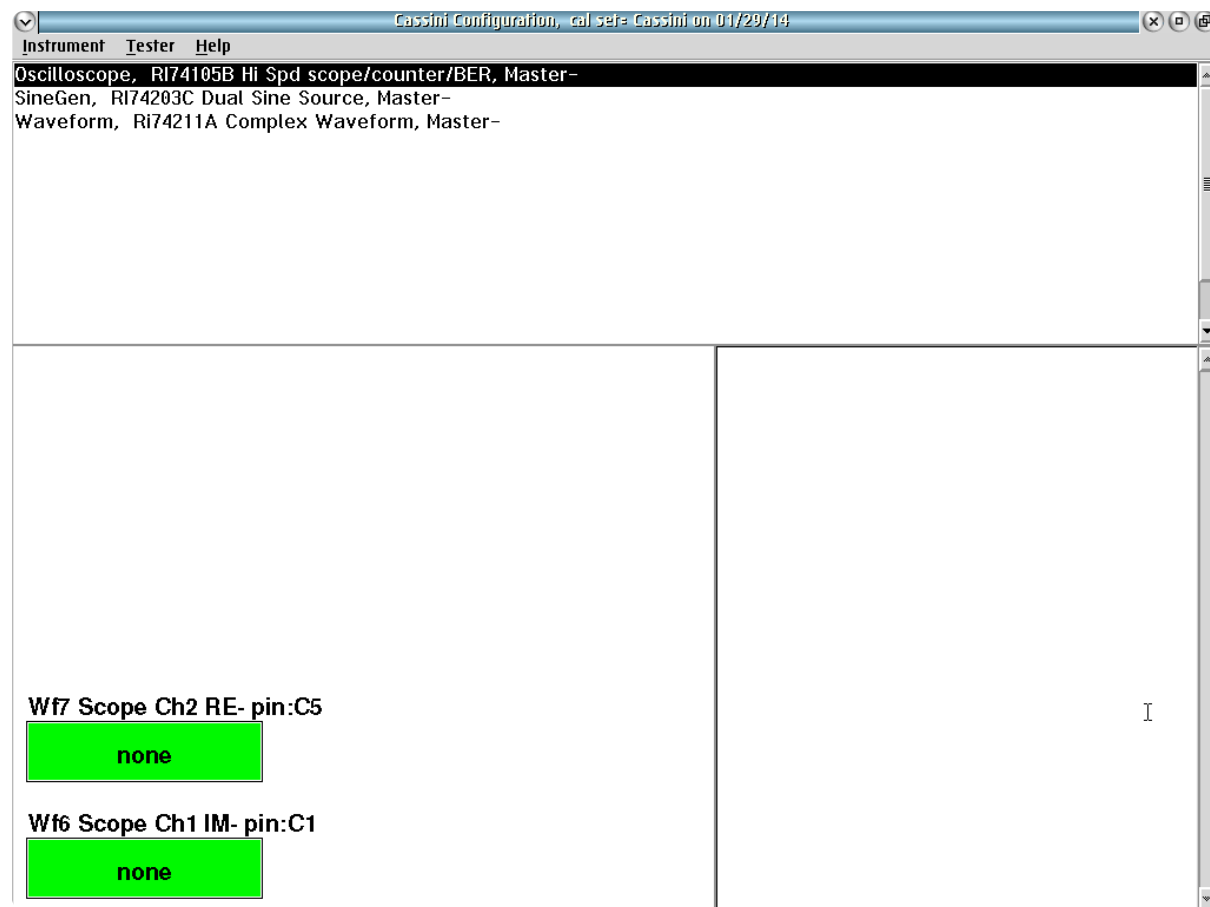
*NOTE: Multiple RI8594 instruments are enumerated incrementally by the system as “2”, “3”, etc. in the configuration, edit, and control panels (i.e - Oscilloscope, SineGen, Waveform; Oscilloscope2, SineGen2, Waveform2; Oscilloscope2, SineGen2, Waveform2; etc).*

*The “x” in RI8594x denotes the model revision number.*

## CONFIGURATION PANELS

Configure the Instruments in this TIM.

### CONFIGURATION PANELS 4 RI8572: WAVEFORM GENERATOR & MEASURE



Shows the **Oscilloscope** connections.



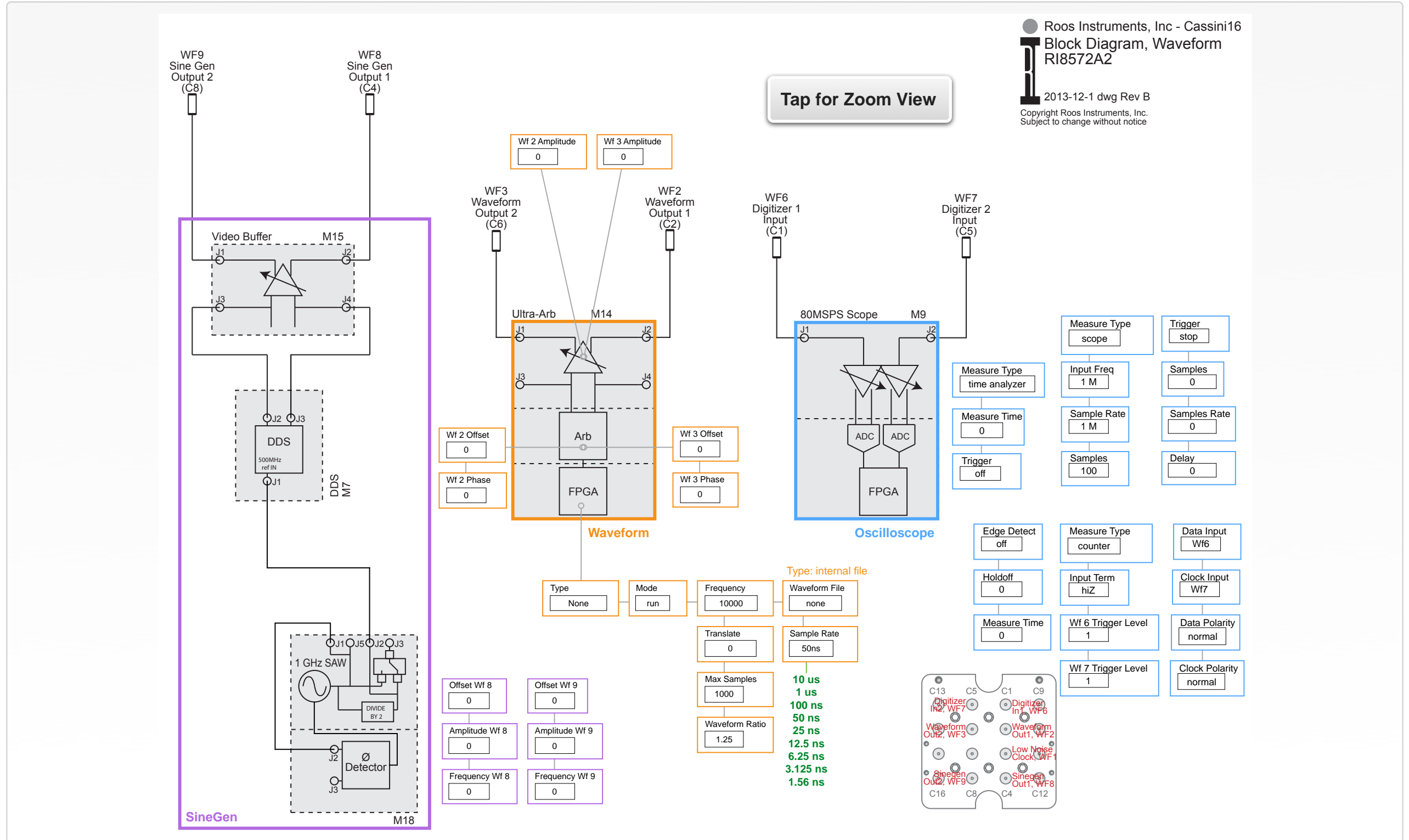
## WAVEFORM

### EDIT PATTERNS

This button displays the current waveform/pattern loaded into the Waveform instrument's arbitrary waveform generator. A left-button click on the button opens the Edit Waveform Patterns window (See [Figure 2.1](#)). The left pane of the Edit Patterns window displays a list of all waveforms that have been loaded into the instruments on-board memory. Selecting any of these waveforms with a left-mouse button displays more information in the right pane: start address in memory, number of samples, sample clock rate, peak magnitude, RMS magnitude in dB, and information about the original waveform file from Guru. New waveforms can be added to the list by selecting 'Pattern' > 'add from Guru' from the menu options. The user can then select a waveform from Guru and specify additional information.

*NOTE: Waveforms are programmed into memory sequentially. While waveforms can be removed from the list view by selecting them and using the menu option "Pattern > remove," they are not erased from the memory. To make used memory available again, all waveforms must be purged using the "Pattern > Erase > All Patterns" menu option.*

### INSTRUMENT BUTTON DIAGRAM 2.8



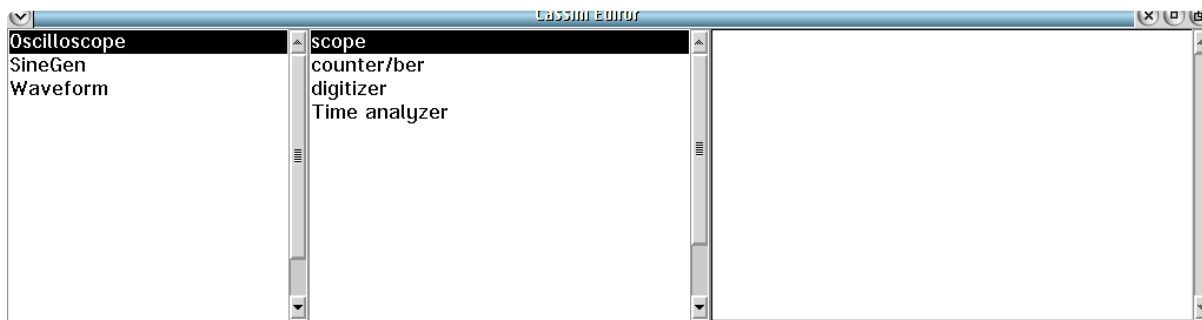
Roos Instruments, Inc - Cassini16  
 Block Diagram, Waveform RI8572A2  
 2013-12-1 dwg Rev B  
 Copyright Roos Instruments, Inc.  
 Subject to change without notice

Tap for Zoom View

## EDIT PANELS

Automated control of the instruments in this TIM with use by the Test Plan Editor.

### EDIT PANELS 11 RI8572: WAVEFORM GENERATOR & MEASURE



**Measure Type**

scope

**Input Freq**

1 M

**Sample Rate**

1 M

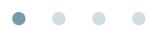
**Samples**

100

**MEAS**

Complex vs Time **A**

Oscilloscope **scope** panel provides basic state and measurement buttons.



## OSCILLOSCOPE

### PANEL: SCOPE

**Measure Type**

counter

### Measure Type

Drop down list button that sets the operation type for the oscilloscope instrument. This button is found in the ‘scope’, ‘counter/ber’, and ‘time analyzer’ subsystem panes of the oscilloscope. Buttons and blocks found in these subsystem panes are settings/parameters used by the corresponding function choice of this button. The description of each function is as follows:

The ‘scope’ setting is an oscilloscope function optimized for signal capture of sinusoidal waveforms from 1 Hz to 80 MHz.

The ‘digitizer’ setting is a digitizing oscilloscope function for arbitrary signals from 1 Hz to 80 MHz.

The ‘counter’ setting performs frequency counting operation of sinusoidal, square-wave, and pulse signals. This function requires a voltage reference or trigger and several periods of the input signal to accurately compute signal frequency.

The ‘time analyzer’ setting performs timing computations of signal events using a trigger and a user-defined measurement timing window.

The 'ber' setting performs a bit error rate calculation. A predefined, pseudo-random gray code bit stream is emitted from the user-selected port. The digitizer captures the return signal after a user-specified wait or trigger time and then calculates the bit error rate.

The 'reciprocal' setting performs a signal frequency count using a reciprocal count method optimized for faster computation of signals below 1 MHz. The reciprocal counter uses the input signal as a trigger and counts the internal clock edges across one period of the input signal.

Input Freq

1 M

### Input Freq

Decimal notation input button that sets the frequency of the expected input signal in units of Hz. The expected input frequency value enables accurate signal reconstruction of input signals with frequency values greater than the Nyquist sample rate of the oscilloscope.

*NOTE: This button enables a Cassini system compiler directive to compensate for signal path calibrations for a known frequency value.*

Samples

100

### Samples

Decimal notation input button that sets the total number of samples in the oscilloscope capture window.

*NOTE: Maximum number of samples is 2000.*

Sample Rate

1 M

### Sample Rate

Decimal notation input button that sets the oscilloscope's sample rate in units of Hz.

*NOTE: Maximum sample rate is 80MS/s*





### Meas: Complex vs Time

Measurement block that computes an RiComplex Voltage vs time result. Using port WF7 as the real (in-phase) signal component and the WF6 port as the imaginary (quadrature) signal component, the block computes a voltage vector representation of an I/Q baseband signal by digitizing each channel independently and then time-interleaving the channels.

### PANEL: COUNTER/BER

Measure Time

0

### Measure Time

Decimal notation input button that sets the measurement window for counter measurement gating in units of seconds. Maximum time limit is  $2000 \times \text{Sample Rate}$ .

Edge Detect

off

### Edge Detect

Drop down list button that sets the edge detector mode. Option 'off' deactivates edge detection. The 'rising' option sets the detector to generate edges, trigger, or count on rising edge event types in the data input. The 'both' option sets the detector to generate edges, trigger, or count on both rising and falling edge event types in the data input.

*NOTE: This button must be set to either 'rising' or 'both' for event counting.*

## Data Polarity

Drop down list button that sets the data input polarity for counter or bit error rate measurements. The 'normal' option is positive or rising edge count/trigger. The 'inverted' option is falling or negative edge count/trigger.

Data Polarity

normal

## Data Input

Drop down list select button that selects the instrument resource port for measurements. The option 'Wf6' sets WF6, located at port position C1 on the instrument head, as input to the digitizer. The option 'Wf7' sets WF7, located at port position C5 on the instrument head, as input to the digitizer. The option 'off' internally disconnects all input ports or paths from the digitizer instrument.

Data Input

Wf6

## Clock Polarity

Drop down list button that sets the polarity of the clock. The 'normal' option is positive or rising edge count/trigger. The 'inverted' option is falling or negative edge count/trigger.

Clock Polarity

normal

## Clock Input

Drop down list select button selects the clock input for bitt error rate measurements. The 'Wf6' sets the signal available at the WF6 port located at position C5 on the instrument head as the clock input. The 'Wf7' sets the signal available at the WF7 port located at position C1 on the instrument head as the clock input. The 'off' option uses the instruments internal clock.

Clock Input

off

## Wf 7 Trigger Level

Decimal notation input button that sets the trigger comparator level voltage for WF7. Valid range of inputs is  $\pm 0.4V$

Wf7 Trigger Level

1

## Wf 6 Trigger Level

Decimal notation input button that sets the trigger comparator level voltage for WF6. Valid range of inputs is  $\pm 0.4V$

Wf6 Trigger Level

1

### Input Term

Drop down list button sets the input termination value to 'hiZ' representing a high impedance value of approximately 10kΩ or '50ohm' for 50Ω.

Input Term

### Holdoff

Decimal notation input button that sets the time in seconds that the edge/gate is disabled after sensing a trigger event. The range of values is 150ns to 25μs.

Holdoff

*NOTE: Typically set to the rise time of the edge.*

### Meas: Frequency

Measurement block that computes signal frequency of the selected input port set by **Data Input** button. The **Measure Time** button sets the capture window time.

MEAS

A rectangular icon with a grey border and a white background. The word "Frequency" is centered in the white area. A small black square with a white letter "A" is in the bottom right corner.

*NOTE: A minimum of two edge/rise or fall time events is required for accurate frequency count.*

### Meas: Period

Measurement block that computes the time between signal edges of the selected input port set by **Data Input** button. The block uses the **Measure Time** button to set the capture window time.

*NOTE: A minimum of two edge/rise or fall time events is required for accurate period measurement.*

MEAS

A rectangular icon with a grey border and a white background. The word "Period" is centered in the white area. A small black square with a white letter "A" is in the bottom right corner.

### Meas: Bit Error Rate

Measurement block computes the ratio of errors to bits (BER) in a bitstream of the selected input port set by **Data Input** button. The **Measure Time** button sets the capture window time.

MEAS

A rectangular icon with a grey border and a white background. The words "Bit Error Rate" are centered in the white area. A small black square with a white letter "A" is in the bottom right corner.

**PANEL: DIGITIZER**

Delay

**Delay**

Decimal notation input button that sets the delay in units of seconds with a resolution of 1µs before a digitizer measurement or to offset the start of a record. Maximum delay value is 2000\***Sample Rate**.

Sample Rate

**Sample Rate**

Decimal notation input button that sets the digitizer sample rate in Hz. The valid sample rate range is 1 Hz to 80 MHz.

Trigger

**Trigger**

Drop down list button that is used within a pre-measure group to set the start and stop times of signal captures or bit error rate measurements. The ‘start’ option triggers an event collection. The ‘stop’ option ends the event collection.

*NOTE: This button is used in conjunction with triggered measurements types.*

Samples

**Samples**

Decimal notation input button that sets the measurement record length for the digitizer. Maximum value is 2000.

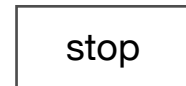
MEAS

**Meas: Triggered Voltage**

Measurement block computes a single voltage vector sample from an I/Q input signal voltage vector using a pre-measure group trigger button. The sample point is set by the system measure reference plus any user specified delay using the **Delay** button. The block generates a single RiComplexVoltage value.

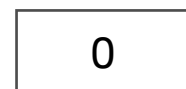
**MEAS****Meas: Triggered Digitizer**

Measurement block computes multiple samples of an I/Q input signal's voltage vector using a pre-measure group trigger button. Sample points begin at the system measure ref plus any user specified delay using the **Delay** button. The block computes and time-interleaves the two signal channels into RiComplexVoltage values.

**PANEL: TIME ANALYZER****Trigger****Trigger**

Drop down list button that is used within a pre-measure group to set the start and stop times of signal captures or bit error rate measurements. The 'start' option triggers an event collection. The 'stop' option ends the event collection.

*NOTE: This button is used in conjunction with triggered measurements types.*

**Measure Time****Measure Time**

Decimal notation input button that sets the measurement window for counter measurement gating in units of seconds. Maximum time limit is 2000 samples\***Sample Rate**

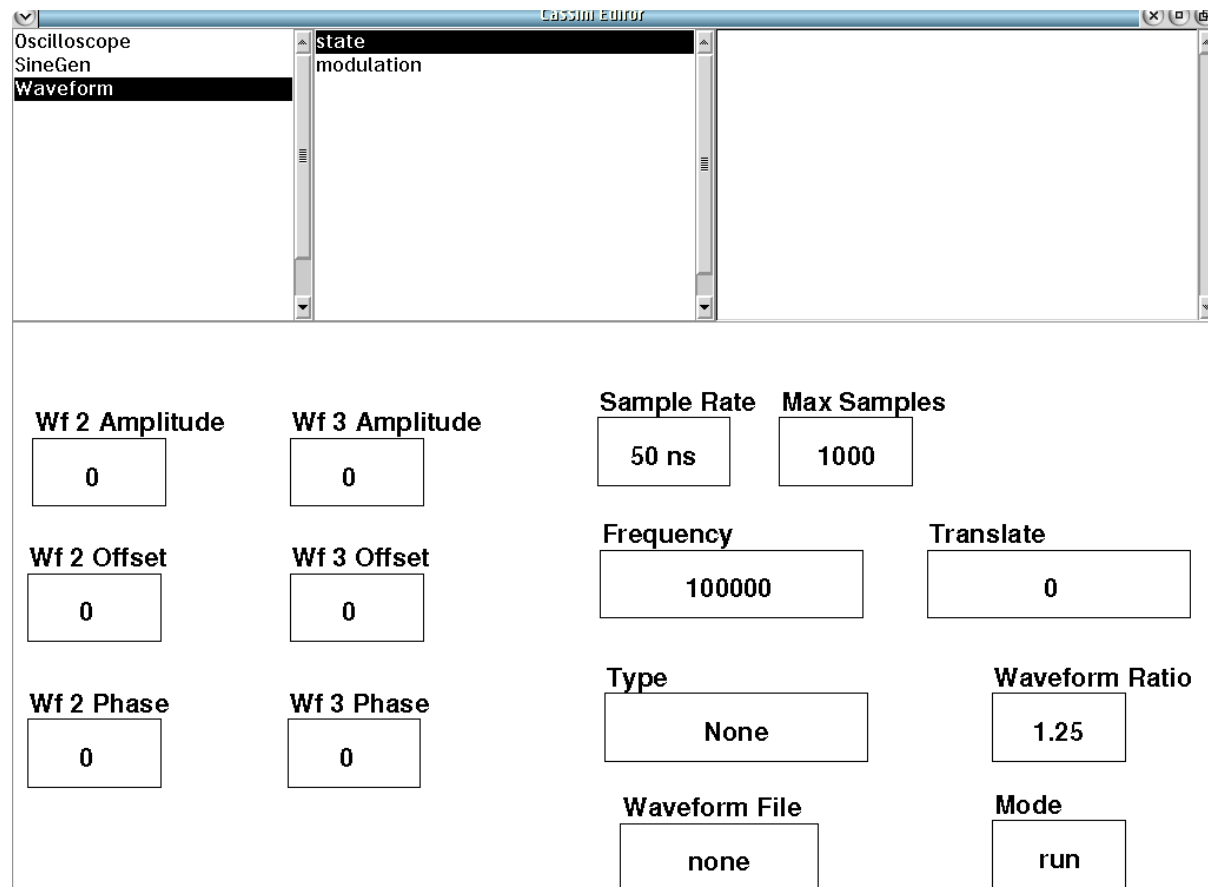


**MEAS****Meas: TriggeredTimeStamp**

Measures events from the counter system. Generates an RiTimeD data type with an entry for each edge. Measure is started and stopped by the Trigger in the pre-measure. Use MeasureTime for the length to examine. Samples must exceed the measure time such that several samples occur after the time completes.

## WAVEFORM

### EDIT PANELS 12 RI8572: WAVEFORM GENERATOR & MEASURE



Waveform **state** panel provides basic state buttons for the waveform instrument.



## PANEL: STATE

Wf3 Amplitude

### Wf 3 Amplitude

Decimal notation input button that sets the amplitude of the open circuit peak voltage of the in-phase (real) signal component. The signal is available at WF3 located at position C6 on the instrument head. Maximum value is 2.5 volts peak.

Wf3 Phase

### Wf 3 Phase

Decimal notation input button that sets the waveform delay in units of degrees of the in-phase (real) signal at WF3 located at position C6 on the instrument head. The range of values is  $\pm 180$ .

Wf3 Offset

### Wf 3 Offset

Decimal notation button that sets the signal offset voltage for the waveform at WF3 located at position C6 on the instrument head. Available range is  $\pm 3V$ .

*NOTE: The output waveform plus the offset cannot exceed  $\pm 3$  volts.*

## Wf 2 Amplitude

Decimal notation input button that sets the amplitude of the open circuit peak voltage of the quadrature (imaginary) signal component. The signal is available at WF2 located at position C2 on the instrument head. Maximum value is 2.5 volts peak.

Wf2 Amplitude

0

## Wf 2 Phase

Decimal notation input button that sets the waveform delay in units of degrees of the quadrature (imaginary) signal at WF2 located at position C2 on the instrument head. The range of values is  $\pm 180$ .

Wf2 Phase

0

## Wf 2 Offset

Decimal notation button that sets the signal offset voltage for the waveform at WF2 located at position C2 on the instrument head. Available range is  $\pm 3V$ .

Wf2 Offset

0

*NOTE: The output waveform plus the offset cannot exceed  $\pm 3$  volts.*

Frequency

100000

## Frequency

Decimal notation input button that sets the waveform frequency in units of Hz. When modulating the signal/s this button sets the center frequency. The range of frequencies available are 1 kHz to 35 MHz

Translate

0

## Translate

Decimal notation input button that generates two sinusoidal tones on WF2 and/or WF3 on either side of the **Frequency** button value by a user-defined value in units of Hz. For example, a **Frequency** value of 1 MHz and a **Translate** value of 100 kHz generates tones at 900 kHz and 1.1 MHz. Range of **Frequency**  $\pm$  **Translate** values must remain between 1 Hz - 20 MHz.

*NOTE: The translate button provides direct control of the arbitrary waveform generator's DDS and can be used to generate a sinusoidal signal on WF2/WF3 up to 80 MHz by setting the Sample Rate button to '1.56 ns', the Frequency button to 0 Hz, and the Wf2/Wf3 Amplitude button to the desired level. This multi-purpose feature can also be used to generate low frequency two-tone signals for intermodulation measurements.*

**Type**

none

**Type**

A drop down list button that outputs a two-channel, baseband waveform on WF2 (quadrature/imaginary) and WF3 (in-phase/real) from built-in modulation waveform types:

‘Quad’ - Quadrature sinusoidal waveforms (WF3 leads WF2 in phase by 90 degrees).

‘Fast Quad’ - This mode is no longer supported.

‘Sine’ - produces a sinusoidal waveforms on WF6 and/or WF7 with parameters defined by the user.

‘Dual Sine’ - This mode is no longer supported.

‘SSB Dual Sine’ - Single sideband, dual sine waves on WF6/WF7. This mode produces two sinusoidal waveforms on a single channel specified by the user with Frequency 1= **Frequency** setting, and Frequency 2=**Frequency** \* **Frequency Ratio**.

‘SqWave’ - produces a square-wave signal on WF6 and/or WF7 with parameters defined by the user.

‘modulation’ - produces a modulated waveform using the button parameters found in the modulation pane of the waveform instrument.

‘file’ - This mode is no longer supported.

‘internal file’ - enables a user-defined signal specified by the **Waveform File** button in the edit panel. The list of waveforms in the **Waveform File** button can be edited by adding or removing waveform files to the TIM from Guru via the **Edit Patterns** button in the Configuration Panel. ‘internal file’ - This mode is no longer supported.

**Waveform Ratio**

1.25

**Waveform Ratio**

Decimal notation input button that used with the ‘SSB Dual Sine’ mode to generate two sinusoidal tones at frequency values that are a ratio value of each other on a single channel for WF6 or WF7. For example, a **Frequency** value of 2 MHz and **Waveform Ratio** of 1.25 produces a tone at 2 MHz and 2.5 MHz. Range of valid inputs is 1 to 2.

**Sample Rate**

50 ns

**Sample Rate**

A drop down list button that sets the time between the waveform data’s next sample output. Sample rates options are ‘10  $\mu$ s’ (100 kHz), ‘1  $\mu$ s’ (1 MHz), ‘100 ns’(10 MHz), ‘50 ns’(20 MHz), ‘25 ns’ (40 MHz), and ‘12.5 ns’ (80 MHz), ‘6.25 ns’ (160 MHz), ‘3.125 ns’(320 MHz), and ‘1.56 ns’(640 MHz).

For 'sine', 'quad', and 'SSB Dual Sine', the **Sample Rate** must be typically **Sample Rate**  $\geq 8 \times$  **Frequency** for accurate signal generation.

*NOTE: For the "Pattern" type files the maximum sample rate is '25 ns'*

### Max Samples

Decimal notation input button that sets the number of samples in the emitted waveform. Maximum value is 2000.

Max Samples

1000

### Mode

Drop down list button that enables or triggers a burst of an emitted waveform.

The 'run' value is used in global or section defaults or within a test panel to initiate a waveform.

The 'stop' value is used in global or section defaults or within a test panel to cease a waveform.

The 'pmStart' value is used to trigger a burst of the waveform with a precision start time designated by the user within a test panel using a pre-measure sequence grouping.

Mode

run

The 'pmStop' value is used to trigger the end of a waveform burst with a precision stop time designated by the user within a test panel using a post-measure sequence grouping.

The 'trigger' value is used to start a waveform burst with a pre-set start time of 0 and is terminated by the user within a test panel using a 'pmStop' in the post-measure sequence grouping.

*NOTE: 'pmStart' and 'pmStop' must be used together within a test panel for the desired result of syncing the waveform with an event or user start time.*

### Waveform File

Drop down list button chooses waveforms that have been preloaded into the instrument.

Waveform File

none



**PANEL: MODULATION****Filter**

A drop down list button that selects a digital filter type to be applied to the waveform. Built-in types include: “Raised Cosine”, “Gaussian”, “GMSK”, or a user-defined filter type provided by the **Filter File** button.

Filter

none

**Filter Bw**

A decimal notation input button that sets the ratio of the selected filter’s bandwidth with the symbol bandwidth.

Filter Bw

1.0

**Filter Taps**

Decimal notation input button that sets the total number of digital filter coefficients.

Filter Taps

0

**Mod Index**

A decimal notation input button that sets the ratio of the excursions of the modulated signal to the level of the unmodulated carrier.

Mod Index

1.0

**Data Bits**

An integer value button that sets the number of data points per record.

Data Bits

100

**Data Rate**

An integer value button that sets the output data point rate in units of Hz

Data Rate

1000000

**Modulation Type**

A drop down list button that selects a modulation from the built-in standards: “Ran FSK” - Random Frequency Shift Keying, “8PSK” - 8

Modulation Type

none

Symbol Phase Shift Keying, 'Edge', 'QPSK' Quadrature Phase Shift Keying, 'FM Tone', and 'AM Tone'.

### Filter File

A drop down list button that selects the file name of a user-defined digital filter taps or coefficients file.

Filter File

none

### Prn Type

A drop down list button that selects the size of the pseudo random number seed used in the sequence generator. i.e "PN5", "PN7", "PN9", etc.

Prn Type

none

### Data Delay

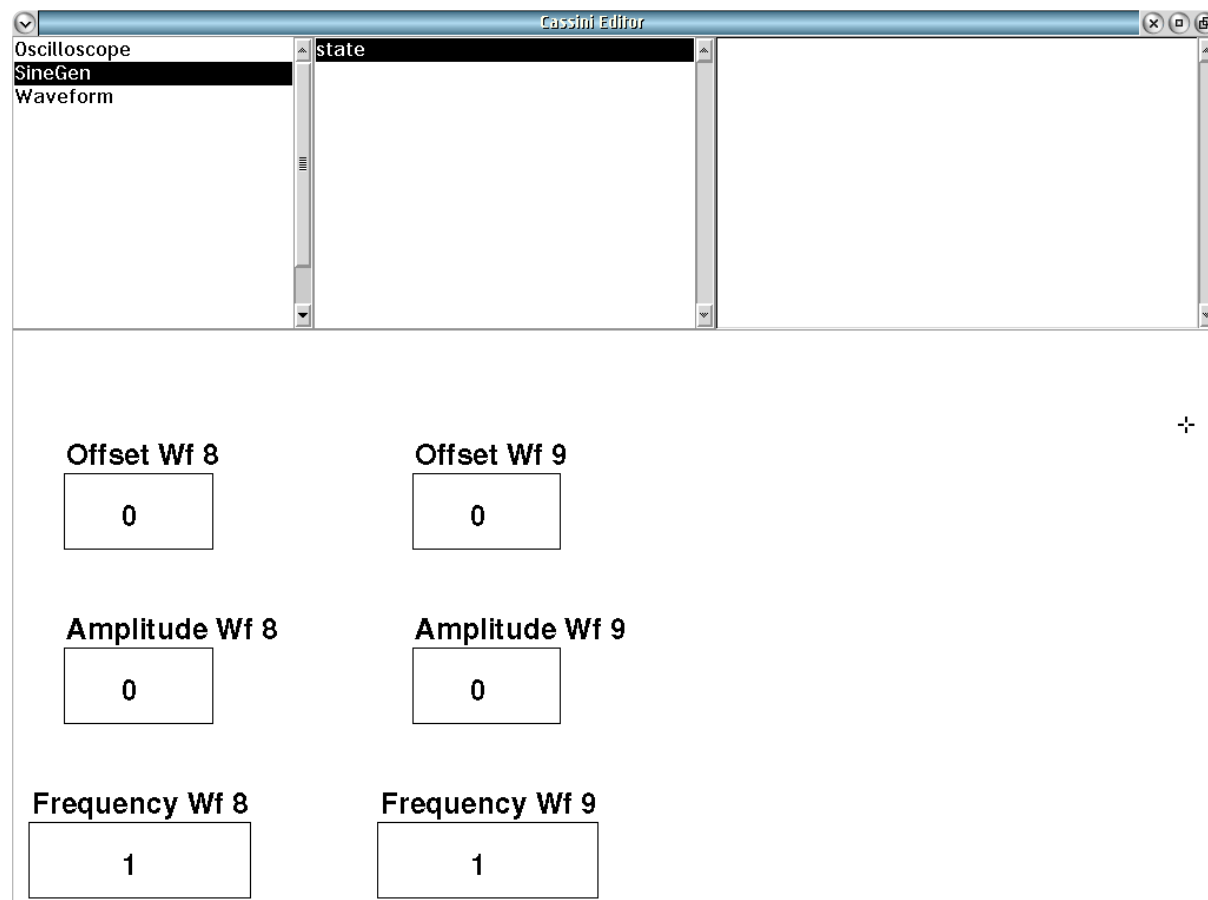
A decimal notation input button that sets the data output delay in units of seconds with a resolution of 1  $\mu$ s.

Data Delay

0

# SINEGEN

## EDIT PANELS 13 RI8572: WAVEFORM GENERATOR & MEASURE



SineGen **state** panel provides basic state buttons for the simple sine wave generator.

### PANEL: STATE

#### Frequency Wf 8

#### Frequency Wf 8

Decimal notation button that sets the output sine wave's frequency in MHz. The range of frequencies are 1kHz to 90MHz.

#### Amplitude Wf 8

#### Amplitude Wf 8

Decimal notation input button that sets the amplitude of the open-circuit, peak-to-peak voltage of the in-phase (real) signal component. The signal is available at WF8 located at position C4 on the instrument head. Input value is peak-to-peak voltage (i.e - a value of 2 results in a +1 V to -1 V signal). Maximum value is 2.5 volts.

#### Offset Wf 8

#### Offset Wf 8

Decimal notation button that sets the signal DC offset voltage for the waveform at WF8 located at position C4 on the instrument head. Available range is  $\pm 3V$ .

*NOTE: The output waveform plus the offset cannot exceed  $\pm 3$  volts.*

**Frequency Wf 9****Frequency Wf 9**

Decimal notation button that sets the output sine wave's frequency in MHz.

**Amplitude Wf 9****Amplitude Wf 9**

Decimal notation input button that sets the amplitude of the open-circuit, peak-to-peak voltage of the quadrature (imaginary) signal component. The signal is available at WF9 located at position C8 on the instrument head. Input value is peak-to-peak voltage (i.e a value of 2 results in a +1 V to -1 V signal). Maximum value is 2.5 volts.

**Offset Wf 9****Offset Wf 9**

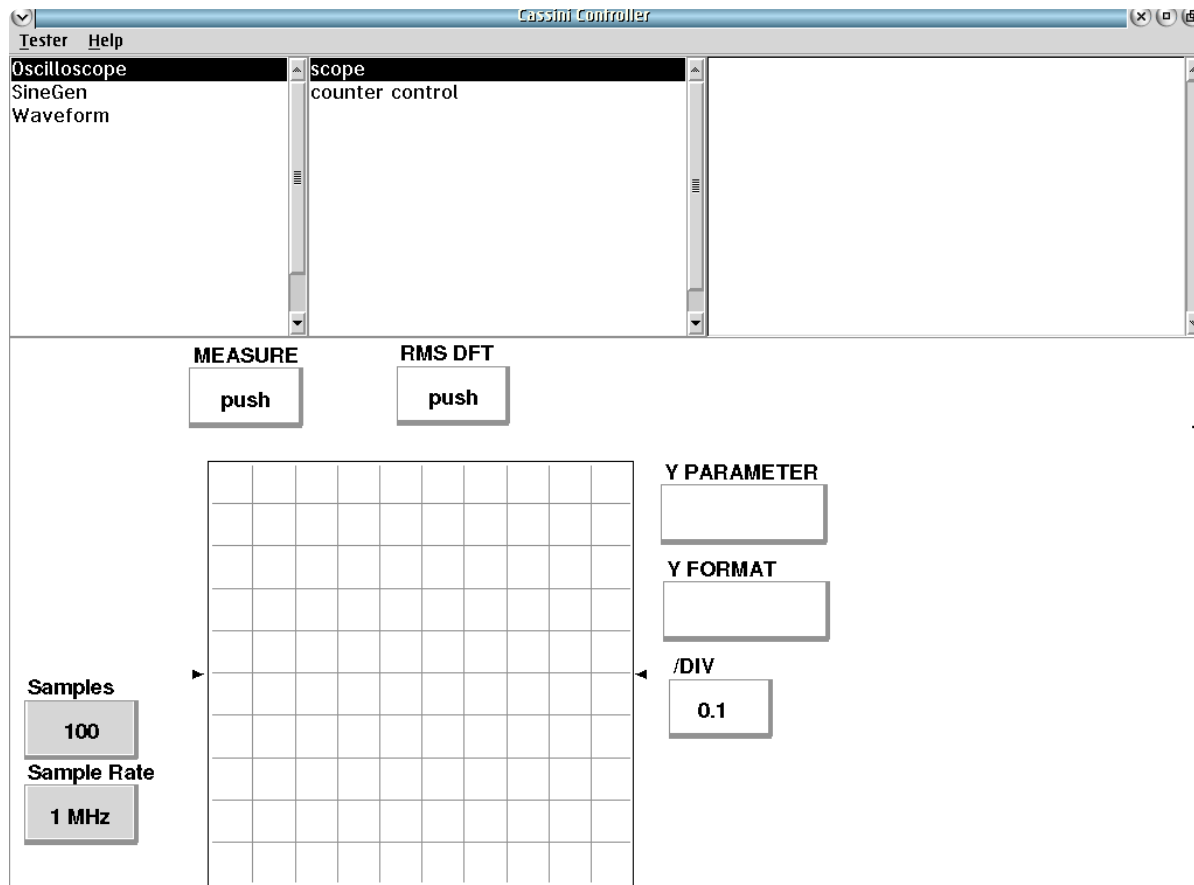
Decimal notation button that sets the signal DC offset voltage for the waveform at WF9 located at position C8 on the instrument head. Available range is  $\pm 3$  V.

*NOTE: The output waveform plus the offset cannot exceed  $\pm 3$  volts.*

# CONTROL PANELS

Real-time control of the instruments in this TIM.

## CONTROL PANELS 9 RI8572: WAVEFORM GENERATOR & MEASURE



Oscilloscope **Scope** panel displays oscilloscope measurements graphically.



# OSCILLOSCOPE

## SCOPE

### MEASURE, RMS DFT, Y PARAMETER, Y FORMAT, /DIV

Update the graph with measured values in real-time.

### COUNTER CONTROL

### Edge Period, COUNTER FREQ, COUNTER

Click to update measurement in real-time.



# RI8574: SYSTEM CONTROLLER (EPC)



## TOPICS

---

[Instruments Provided by this TIM](#)

[Edit Panel Button Descriptions](#)

[Temperature Control Buttons](#)

[Control Panel](#)

Tap the links above to quickly access content

## INSTRUMENTS PROVIDED BY THIS TIM

The instruments in this TIM appear as **DataSim** and **System** and the Infrastructure provides a **Tester** instrument in the panel dialog windows.

Model and Name as it appears in the Tester Configuration:

- System, System Resources 2

Infrastructure includes one of the following:

- Tester, Ri8568x Cassini 16 Slot Tester, Master
- Tester, Ri8549x Cassini 8 Slot Tester, Master

*NOTE: The “x” in the model number denotes the revision of the Instrument. In this case, the Infrastructure provides the hardware the Tester instrument displays.*

Optional Instruments may include:

- TempControl, Temptronics TP04310A Temperature Controller (or compatible)

## EDIT PANELS

Automated control of the system level instrument in this TIM with use by the Test Plan Editor.

*NOTE: TempControl is an optional feature that requires a RIFL pod for instrument control.*

### EDIT PANELS 14 RI8574: SYSTEM CONTROLLER



System **data saves** panel enables datalog and local variable control in a test plan.



**PANEL: DATA SAVES****Save Unspecified**

An input block used to save single datapoint or multiple numerical data values from a test panel to the data log worksheet. This save type enables measurement data to be offloaded as CSV, STDF, RITdB or other standard data log format. The name of the data save is defined by the user by right-clicking within the gray area of the block and selecting 'Data Name' from the pop-up menu list.

Data Type Information

The data type of the stored value or values is inherited from the connected measurement/calculation block. Accordingly, the data unit choices are limited to the data type of the connected measurement/calculation blocks. The unit options can be accessed by a right-click and selection of 'Data Format' from the pop-up menu list.

Viewing Data Save Values in a Plot

Data saved to this block can be viewed in a data plot after the test plan has been compiled and executed by left-clicking within the gray area of the block and selecting the plot type from the pop-up window list.

**Save Unspecified**Applying Measurement Limits to Data Save Values

Measurement limits can be applied to this data save type by right-clicking within the gray area of the block and selecting 'Single-valued Limit' or 'Multi-valued Limit' if more than one measurement value is saved.

*NOTE: If a single numerical value is saved, the measurement limit will default to a single-value limit. If multiple numerical values are saved, the measurement limit will allow a multi-value limit option.*

**Array**

An input block that can store a single datapoint or multiple numerical data values as a local variable with the associated instrument setting values used in the panel or test section defaults to index the stored values as a multi-dimensional array. The storage structure of an **Array** block allows measurement data to be sorted and/or plotted relative to an instrument state or multiple states (typically frequency or power sweeps) in which the data was saved in a test panel by using the same instrument setting blocks in the test panel. This allows cross referencing measured values against multiple instrument state indices such as signal power, frequency, voltage settings, etc. when displaying in a plot or when accessed using an **Array**, **Array Src**, or

**Array**

**Array Element** output block in subsequent test panels or sections. The name of the array can be defined by the user by right-clicking within the gray area of the block and selecting 'Var Name' from the pop-up menu list.

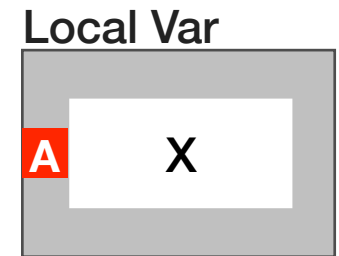
#### Data Type Information

The data type of the stored value or values is inherited from the connected measurement/calculation blocks. There are no measurement units associated with an **Array**.

#### Viewing Array Values in a Plot

Data saved to this block can be viewed in a data plot after the test plan has been compiled and executed by left-clicking within the gray area of the block and selecting the plot type from the pop-up window list.

If multi-dimensional data is saved to an array, i.e - measurement data with more than one independent variable(multiple instrument settings) associated with a measured datapoint, the multi-variable plot window will open when left-clicking within the gray area of the block. This window allows the user to define the which instrument index will define the independent variable on the x-axis, and color code the plots based on a second instrument setting independent variable.



### Local Var

An input block used to save single datapoint or multiple numerical data values from the the test plan to a local variable. The name of the local variable can be defined by the user by right-clicking within the gray area of the block and selecting 'Var Name' from the pop-up menu list.

#### Data Type Information

The data type of the stored value or values is inherited from the upstream connected measurement/calculation block. There are no measurement units associated with **Local Var** data.

#### Viewing Local Var Values in a Plot

Data saved to this block can be viewed in a data plot after the test plan has been compiled and executed by left-clicking within the gray area of the block and selecting the plot type from the pop-up window list.



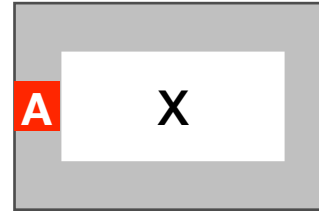
## Local Var Put

An input block used to save a single numerical measurement value from a test panel to a local variable. If multiple data values are input to the **Local Var Put** input block, i.e - measurements from a sweep of power or frequency for instance, every subsequent data point overwrites the previous value. The name of the local variable can be defined by the user by right-clicking within the gray area of the block and selecting 'Var Name' from the pop-up menu list. The value stored in this block can be called using a **Local Var** output block in separate test panel or test section.

### Data Type Information

The data type of the stored value is inherited from the connected measurement/calculation block. There are no measurement units associated with **Local Var** data.

### Local Var Put



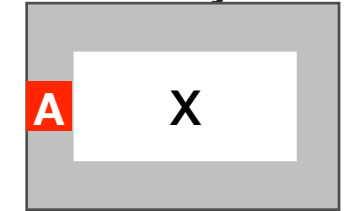
## Sorted by data

An input block that stores a single datapoint or multiple numerical data values to a local variable that can be sorted in ascending order by a parameter of the data such as power or phase. This block is typically used to index data according to ascending measurement value when calling the local variable with a **Local Var** output block or when viewing data in a plot. The name of the **Sorted by data** local variable can be defined by the user by right-clicking within the gray area of the block and selecting 'Var Name' from the pop-up menu list.

### Sort by Data

The data organization can be defined by the user by right-clicking within the gray area of the block and selecting 'Index by...' from the pop-up menu list. A list of available sort types are displayed in the pop-up window based on the data type of the variable.

### Sorted by data



### Data Type Information

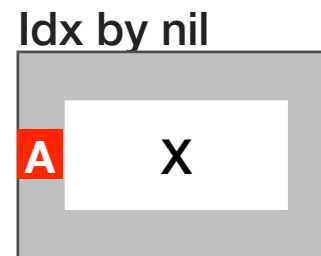
The data type of the stored value or values is inherited from the connected measurement/calculation blocks. There are no measurement units associated with **Sorted by data** variables.

### Viewing Values in a Plot

Data saved to this block can be viewed in a data plot after the test plan has been compiled and executed by left-clicking within the gray area of the block and selecting the plot type from the pop-up window list.

## Idx by nil

The “Index by” input block stores a single datapoint or multiple numerical data values in a local variable with each data point sorted relative to an instrument state in which the data was saved in a test panel. This controls the order in which the measured values are stored relative to an instrument state setting such as signal power, frequency, etc. when displaying in a plot or when accessed using an **Local Var** output block in subsequent test panels or sections. The name of the array can be defined by the user by right-clicking within the gray area of the block and selecting ‘Var Name’ from the pop-up menu list.



### Indexing Data Values

To index measurement data by an instrument setting the input block owner must be changed from the default setting of ‘System’ to the desired instrument. To change the owner, right click anywhere within the white space area contained by the ‘System’ box that surrounds the gray block and select ‘Change Owner’ from the pop-up menu list. A list of available instruments in the current tester configuration will pop-up allowing the user to select the desired instrument. Once the desired instrument owner has been designated, the list of available instrument settings associated with that instrument can be accessed by right clicking within the gray area of the block and selecting ‘State Name’ from the pop-up menu list.

*NOTE: In practical applications, the “Index by” block owner is typically set to an instrument that is being swept across a range of values such as voltage, current, power, or frequency in a test panel or test section. The “Index by” parameter is set to the instrument setting that is being swept in a test panel or test section.*

### Data Type Information

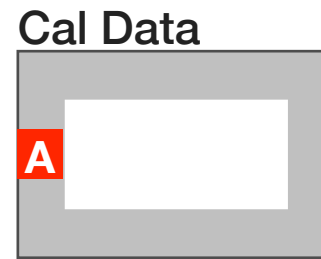
The data type of the stored value or values is inherited from the connected measurement/calculation blocks. There are no measurement units associated with “Indexed by” local variables.

### Viewing Values in a Plot

Data saved to this block can be viewed in a data plot after the test plan has been compiled and executed by left-clicking within the gray

area of the block and selecting the plot type from the pop-up window list.

## Cal Data



A specialized input block that stores a single datapoint or multiple numerical data values (indexed by frequency or power) to a calibration table for an instrument or fixture signal path. The data format saved by the block is translated by the tester as signal path loss compensation, phase reference, or mismatch correction. If calibration data for the specified path or instrument exists, it is overwritten by the measured data when the block is used in a test plan.

This button is typically used in conjunction with the **Cal Reset** button.

---

**WARNING: Altering or otherwise amending instrument calibration data can cause unwanted and/or erratic behavior that may result in instrument or device damage and will void the performance specifications of the Cassini test system.**

---

### Data Type Information

The data type of the stored value or values is inherited from the connected measurement/calculation blocks. The **Cal Data** block requires specific instrument owner and data parameters that allows

the software to automatically apply the measured data as a calibration correction or “error adapter” as it is often called.

### Calibration Naming Conventions

To associate the calibration data to a fixture path, the block owner must be changed from the default setting of ‘System’ to ‘Fixture’. Right click anywhere within the white space area contained by the ‘System’ box that surrounds the gray block and select ‘Change Owner’ from the pop-up menu list.

*NOTE: A fixture must be physically connected and checked into the tester or a fixture definition must be activated in the Configuration Window to access the ‘Fixture’ owner.*

The name of the **Cal Data** block can be defined by the user by right-clicking within the gray area of the block and selecting ‘Cal Name...’ from the pop-up menu list. In order for the calibration data to be applied, the ‘Cal Name’ of the block must match the path name specified in the Device Connection editor for the associated fixture/fixture definition.

---

*CAUTION: Some restricted Cal Data names and instrument owner pairs are reserved for instrument calibration parameters. Contact [support@roos.com](mailto:support@roos.com) before creating and executing test plans that may alter or overwrite instrument calibration data.*

---

### Viewing Values in a Plot

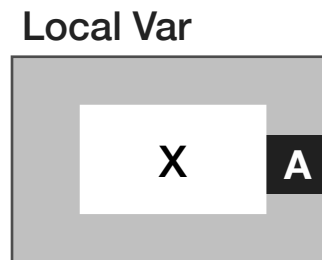
Data saved to this block can be viewed in a data plot after the test plan has been compiled and executed by left-clicking within the gray

area of the block and selecting the plot type from the pop-up window list.

Saving & Applying Calibration Data

After a test plan using a **Cal Data** block is complete, the calibration data will be temporarily active in the associated fixture path while the fixture remains connected or the fixture definition remains active in the Configuration Window. The calibration data can be saved permanently to the fixture by

**Cal Data** blocks used in a calibration or fixture calibration test plan typically include measurement limits or validation test plans to verify the quality/efficacy of the resulting calibration data. These test plan types when executed by a Calibration Executive or Fixture Executive program automatically save the associated path/instrument calibration data from the **Cal Data** block permanently upon completion of a test plan pass.



**Local Var**

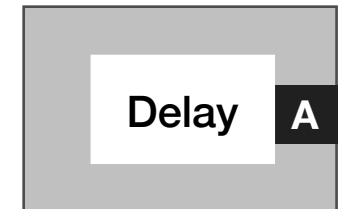
An output block that calls previously saved local variable data(single or multiple values) generated by a **Local Var** or **Local Var Put** input block. The data type of recalled values are set by the inherited data

type when the data was captured in a **Local Var** or **Local Var Put** Input block.

The local variable can be selected by right-clicking anywhere within the gray area of the block and selecting 'Var Name' from the pop-up menu list. A window list of available local variables will be displayed from which a single variable can be selected.

*NOTE: The local variable data is not valid in the test panel in which the data was saved to a Local Var or Local Var Put input block. A call to a local variable must occur in a test section or test panel that occurs after the local variable save.*

**Instr State Source**



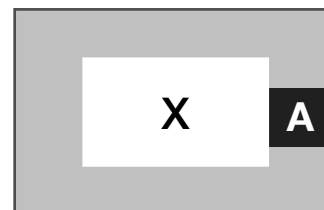
**Instr State Source**

An output block that provides instrument settings as a numerical value or multiple values from the current test panel. For example, if a test panel swept the Source1 frequency from 1GHz to 10GHz in 100MHz steps, the 101 frequency setting points of Source1 could be accessed by placing the **Instr State Source** button in the panel, setting 'Source1' as the owner, and 'Frequency' as the instrument state source parameter.

To access an instrument's available settings the owner must be changed from the default setting of 'System' to the desired instrument. To change the button owner, right click anywhere within the white space area contained by the 'System' box that surrounds the gray block and select 'Change Owner' from the pop-up menu list. A list of available instruments in the current tester configuration will pop-up allowing the user to select the desired instrument. Once the desired instrument owner has been designated, the list of available instrument settings associated with that instrument can be accessed by right clicking within the gray area of the block and selecting 'State Name' from the pop-up menu list.

*NOTE: The instrument state source button incurs no test or measurement time impact because there is no measurement associated with the instrument setting values. The instrument values are available to the Instr State Source block at compile time.*

### Array Src



### Array Src

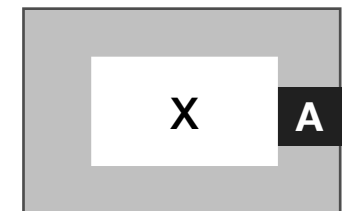
An output block that emits all stored data of the selected array variable as a RIData datatype without the need for indexing the array with instrument buttons. The array variable can be selected by right-clicking anywhere within the gray area of the block and selecting 'Var

Name' from the pop-up menu list. A window list of available local variables will be displayed from which a single variable can be selected.

The local variable data inherits the data type of upstream measurement connected to the **Local Var** input block.

*NOTE: The array variable data is not valid in the test panel in which the data was saved to an Array input block. A call to a Array Src variable must occur in a test section or test panel that occurs after the Array variable save.*

### Array Element



### Array Element

An output block that provides a single datapoint from the selected array variable. The datapoint is extracted by placing an instrument button state of the desired datapoint in the panel with the **Array Element** block to index and extract the value.

*NOTE: The instrument button type and value used to extract the datapoint must match an instrument button type and value used when creating the array.*

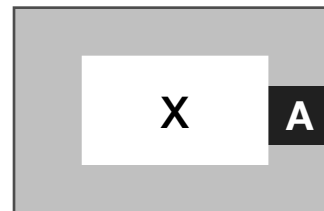


### Data Type Information

The data type of the stored value or values is inherited from the connected measurement/calculation blocks of the **Array** input block. There are no measurement units associated with Array local variables.

*NOTE: The array variable data is not valid in the test panel in which the data was saved to a Array input block. A call to an Array Element value must occur in a test section or test panel that occurs after the Array variable save.*

### Array



### Array

An output block that provides data values from an array variable by using the same instrument panel button/s values used with the associated **Array** input block to index the stored values.

If a group of test panels with arrays have common instrument button sweeps/ranges then the array variables will align the stored values based on that range index. If there is no shared ranges then the entire variable is emitted as a vector.

*NOTE: The instrument button sweep or range used to create the array input block variable must be used to extract the values from the array output block. The button type, values, and range dimension must match the indices used when the array was captured.*

An array local variable can be selected by right-clicking within the gray area of the block and selecting 'Var Name' from the pop-up menu list. A window list of available local variables will be displayed from which a single variable can be selected.

### Data Type Information

The data type of the stored value or values is inherited from the connected measurement/calculation blocks of the **Array** input block. There are no measurement units associated with Array local variables.

*NOTE: The array variable data is not valid in the test panel in which the data was saved to a Array input block. A call to an Array variable must occur in a test section or test panel that occurs after the Array variable save.*

### Cal Data



### Cal Data

An output block that recalls the measured data stored in the user specified **Cal Data** input block. This button is typically used in conjunction with the **Cal Reset** button.

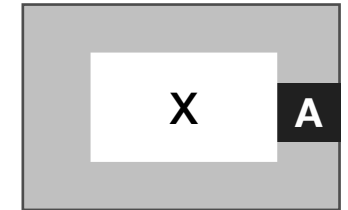
*NOTE: The calibration data from a Cal Data output block is not valid in the test panel in which the data was saved to a Cal Data input block. A call to the calibration data must occur in a test section or test panel that occurs after the calibration data save.*

### Data Type Information

The data type of the stored value or values is inherited from the connected measurement/calculation blocks of the **Cal Data** input block. To recall the calibration data from a previous **Cal Data** input block, the block owner must be changed from the default setting of 'System' to match the owner of the **Cal Data** save. To change the owner, right click anywhere within the white space area contained by the 'System' box that surrounds the gray block and select 'Change Owner' from the pop-up menu list. Once the owner has been changed, the calibration data can be recalled by changing the name of the **Cal Data** output block to match the associated **Cal Data** input block by right-clicking within the gray area of the block and selecting 'Cal Name...' from the pop-up menu list.

*NOTE: To access fixture calibration data, the fixture must be physically connected and checked into the tester or a fixture definition must be activated in the Configuration Window to access the 'Fixture' owner.*

### Cal Point



### Cal Point

An output block that returns a single point cal factor from a specified **Cal Data** input block based on an index determined by an associated instrument's state button (typically a frequency or power setting) placed in the test panel or test section. This button is typically used in conjunction with the **Cal Reset** button.

*NOTE: The calibration data from a Cal Data output block is not valid in the test panel in which the data was saved to a Cal Data input block. A call to the calibration data must occur in a test section or test panel that occurs after the calibration data save.*

### Data Type Information

The data type of the stored value or values is inherited from the connected measurement/calculation blocks of the **Cal Data** input block. To recall the calibration data from a previous **Cal Data** input block, the block owner must be changed from the default setting of 'System' to match the owner of the **Cal Data** save. To change the owner, right click anywhere within the white space area contained by the 'System' box that surrounds the gray block and select 'Change Owner' from the pop-up menu list. Once the owner has been changed, the calibration data can be recalled by changing the name

of the **Cal Data** output block to match the associated **Cal Data** input block by right-clicking within the gray area of the block and selecting 'Cal Name...' from the pop-up menu list.

*NOTE: To access fixture calibration data, the fixture must be physically connected and checked into the tester or a fixture definition must be activated in the Configuration Window to access the 'Fixture' owner.*

Cal Reset



## Cal Reset

A list selection button that resets the calibration data of the user-specified entry to its default value when the test plan is compiled. This button is typically used in conjunction with the **Cal Data** input and output blocks.

---

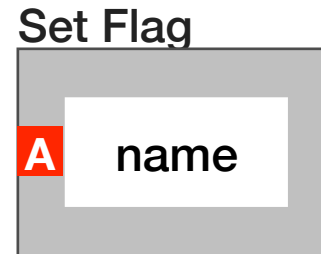
**WARNING: Overwriting or altering instrument calibration data can cause unwanted instrument behavior that may result in instrument or device damage and will void the performance specifications of the Cassini test system.**

---

To reset calibration data, the **Cal Reset** button owner must be changed from the default setting of 'System' to match the owner of the intended path (typically 'Fixture') or instrument. To change the owner, right click anywhere within the white space area contained by the 'System' box that surrounds the Cal Reset parameter box and

select 'Change Owner' from the pop-up menu list. Once the owner has been changed, the calibration data to be reset can be selected by changing the name of the **Cal Reset** button to match the intended fixture path or instrument resource name by right-clicking within the Cal Reset parameter box of the button and selecting 'Cal Name...' from the pop-up menu list.

*NOTE: To reset fixture calibration data, the fixture must be physically connected and checked into the tester or a fixture definition must be activated in the Configuration Window to access the 'Fixture' owner.*

**PANEL: FLOW CONTROL****Set Flag**

An input block that creates a conditional flag based on a single datapoint or multiple data points provided to the block. When placed in a test panel and executed, this block sets the true/false logic conditions of the flag for the **skipIfTrue**, **abortIfTrue**, **skipIfFalse**, and/or **abortIfFalse** buttons that execute conditional test program actions. If multiple data points and limits are applied to a **Set Flag** input block the results are logically OR'ed, i.e - all limit conditions must be true for the flag to be true.

The name of the flag is defined by the user by right-clicking within the gray area of the block and selecting 'Flag Name' from the pop-up menu list.

Conditional data limits are applied to the flag by right-clicking within the gray area of the block and selecting 'Flag Limits' or 'Limit File' if more than one measurement value is saved. Flag limits are displayed on the Set Flag block above the name for reference.

*NOTE: If a single numerical value is saved, the measurement limit will default to a single-value limit. If multiple numerical values are saved, the measurement limit will allow a multi-value limit option.*

skipIfTrue

**skipIfTrue**

A drop down list button placed in the Conditional Statement panel of a test section that skips all test panels within the section if the selected flag specified by a **Set Flag** input block is true. The flag pointer is set by right clicking within the name field of the button and selecting 'Flag Name' from the pop-up menu. A pop-up window then provides the list of available conditional flags based on the Set Flag input blocks used.

*NOTE: The skipIfTrue button must be placed in the Conditional Statement panel of a Test Section. If multiple skipIfTrue buttons are placed in the same Conditional Statement panel, any true flag can cause a skip.*

## abortIfTrue

A drop down list button placed in the Conditional Statement panel of a test section that aborts the test program if the selected flag specified by a **Set Flag** input block is true. The flag pointer of the **abortIfTrue** button is set by right clicking within the name field of the button and selecting 'Flag Name' from the pop-up menu. A pop-up window then provides the list of available conditional flags based on the Set Flag input blocks used.

*NOTE: The abortIfTrue button must be placed in the Conditional Statement panel of a Test Section. If multiple abortIfTrue buttons are placed in the same Conditional Statement panel, any true flag can cause the test program to abort.*

abortIfTrue

name

## skipIfFalse

A drop down list button placed in the Conditional Statement panel of a test section that skips all test panels within the section if the selected flag specified by a **Set Flag** input block is false. The flag pointer of the **skipIfFalse** button is set by right clicking within the name field of the button and selecting 'Flag Name' from the pop-up

skipIfFalse

name

menu. A pop-up window then provides the list of available conditional flags based on the Set Flag input blocks used.

*NOTE: The skipIfFalse button must be placed in the Conditional Statement panel of a Test Section. If multiple skipIfFalse buttons are placed in the same Conditional Statement panel, any false flag can cause a skip.*

abortIfFalse

name

## abortIfFalse

A drop down list button placed in the Conditional Statement panel of a test section that aborts the test program if the selected flag specified by a **Set Flag** input block is false. The flag pointer of the **abortIfFalse** button is set by right clicking within the name field of the button and selecting 'Flag Name' from the pop-up menu. A pop-up window then provides the list of available conditional flags based on the Set Flag input blocks used.

*NOTE: The abortIfFalse button must be placed in the Conditional Statement panel of a Test Section. If multiple abortIfFalse buttons are placed in the same Conditional Statement panel, any true flag can cause the test program to abort.*



promptIfFalse

name
------

## promptIfFalse

A drop down list button placed in the Conditional Statement panel of a test section that pauses the test program and opens a user prompt window if the selected flag specified by a **Set Flag** input block is false. The user prompt window provides two options for the operator: 'Continue' - proceeds with the test program

'Abort' - terminates the test program immediately.

The flag pointer of the **promptIfFalse** button is set by right clicking within the name field of the button and selecting 'Flag Name' from the pop-up menu. A pop-up window then provides the list of available conditional flags based on the Set Flag input blocks used.

*NOTE: The promptIfFalse button must be placed in the Conditional Statement panel of a Test Section.*

Prompt

Click OK to Continue
----------------------

## Prompt

A text string input button placed in a Conditional Statement panel of a test section that pauses the test program at the beginning of a test section and opens a user prompt window and displays the text string input by the user to the button. The prompt window displays the text string and provides two options for the operator: "Continue" - proceeds with the test program; "Abort" - terminates the test program immediately.

*NOTE: The Prompt button must be placed in the Conditional Statement panel of a Test Section.*

**PANEL: STATE**

Sequence Delay

0

**Sequence Delay**

An integer value input button used only in Pre Measure and Post Measure groups that forces a test pause and hold of all instrument settings in the sequence. The **Sequence Delay** button input value is in units of microseconds with 100ns resolution.

*NOTE: The Sequence Delay button is only valid in Pre Measure and Post Measure groups. Within a Pre/Post Measure group, buttons are executed in a sequenced order from left to right as they are placed in the panel.*

Averages

1

**Averages**

An integer value input button that sets the number of measurements taken and used to compute a mean or average value. When placed in a test panel or test section, the **Averages** button applies to all measurements present in the same test panel or test section accordingly. A value of 1 will take only one measurement.

Pause

0

**Pause**

An integer value input button that forces a test pause and hold of all instrument settings in a test panel before a measurement is executed. If a **Pause** button is placed in a test section or test panel, the pause and hold is executed after all instrument button settings are set and before any measurements are taken. If a **Pause** button is placed within a Measure group, the pause and hold is executed after all instrument button settings within the Measure group are set and before the measurement within the Measure group is taken. If a **Pause** button is placed in Global/Section default, the value is ignored. The **Pause** button input value is in units of microseconds with 100ns resolution.

Repeat

0

**Repeat**

An integer value input button that when placed in a test panel, sets the number of times to repeat the measurements in that panel. When the repeat value is greater than one, single data point saves or local variable are represented as multi-point measurements with the repeat number defining the index and the independent axis in plots. It is typically used as a test program debug tool for determining measurement stability.

## Index

An integer value input button that is used as the numeric sorting parameter for data measured using a lock step group. The index button is placed within a lock step group, typically with a measurement block and an instrument parameter such as frequency, power, voltage, etc. When an instrument parameter is swept across a range of values, the **Index** button must also be configured as a range with the same number of values as the instrument sweep parameter. This allows the measured data to be stored in ascending numeric order of the index button values while still conducting the measurement according to ascending instrument parameter values.

*NOTE: When used with an instrument sweep/range, the index button only defines the storage indexing of the sweep, not the execution order of the instrument sweep.*

Index

0

## Trigger Spacing

A decimal notation input button that sets a delay between the trigger reference (represented by a **Trigger Ref** button placed to the left of the **Trigger Spacing** button) and a measurement block. The Trigger Spacing button does not incur any additional execution time during a

Trigger Spacing

0

pre measure sequence and is therefore used to provide precise timing of DC or RF pulse widths. The input value is in units of seconds with a resolution of 100ns.

This button is used with time-based measurements such as **Voltage vs Time**, **Current vs. Time** and/or **Delayed Voltage** measurement blocks.

*NOTE: Only valid in a pre/post measure or measure sequence. The input value to the Trigger Spacing button must be positive.*

## Outer Loop

An integer value button that assigns a state change cost value for all instrument state changes contained in a single test panel in which it is placed. The **Outer Loop** button is a compiler directive that incorporates the input value as an additional cost value associated with changing to the instrument settings of a test panel or the instrument state changes contained within a [Lock Step group](#) in which it is also placed. A higher input value denotes an additional cost value that raises the overall cost value compared to another **Outer Loop** button with a smaller value. The cost value is used by the compiler to prioritize the execution of multiple test panels within a test section in order of the lowest cost values to the highest cost values.

Outer Loop

1

By default the **Outer Loop** button has a higher cost value than the **Inner Loop** button. **Outer Loop** buttons can be used in conjunction with **Inner Loop** buttons within a [Lock Step group](#) to control the execution order of two or more instrument button parameter sweeps/ranges within one test panel. State changes associated with **Inner Loop** buttons with ascending input values are executed before **Outer Loop** buttons with ascending values. The combination of the two buttons enable nested instrument range sweeps across multiple instrument parameters with a user-specified execution order.

*NOTE: When used within a lock step group with an instrument range sweep, the Outer Loop index size must match the sweep index size, i.e. the number of Outer Loop buttons must match the number of points in the sweep.*

Inner Loop

1

## Inner Loop

An integer value button that assigns a state change cost value for all instrument state changes contained in a single test panel in which it is placed. The **Inner Loop** button is a compiler directive that incorporates the input value as an additional cost value associated with changing to the instrument settings of a test panel or the instrument state changes contained within a [Lock Step group](#) in which it is also placed. A higher input value denotes an additional cost value that raises the overall cost value compared to another **Inner**

**Loop** button with a smaller value. The cost value is used by the compiler to prioritize the execution of multiple test panels within a test section in order of the lowest cost values to the highest cost values.

By default the **Inner Loop** button has a lower cost value than the **Outer Loop** button. **Inner Loop** buttons can be used in conjunction with **Outer Loop** buttons within a [Lock Step group](#) to control the execution order of two or more instrument button parameter sweeps/ranges within one test panel. State changes associated with **Inner Loop** buttons with ascending input values are executed before **Outer Loop** buttons with ascending values. The combination of the two buttons enable nested instrument range sweeps across multiple instrument parameters with a user-specified execution order.

*NOTE: When used within a lock step group with an instrument range sweep, the Inner Loop index size must match the sweep index size, i.e. the number of Inner Loop buttons must match the number of points in the sweep.*

Meas Ref

0

## Meas Ref

A decimal notation input button in units of seconds that marks the preceding instrument state button in a pre measure as the start event reference of the measurement block in the panel, offset by the value entered. The input value is in units of seconds with 1 microsecond resolution. A positive input value offsets the measurement time

reference later in time from the start event reference by the input value. A negative input value moves the measurement time reference earlier than the start event reference by the input value. The measurement reference defines the zero index or left-most edge of data plots.

This button is used with time-based measurements such as **Voltage vs Time**, **Current vs. Time** and/or **Delayed Voltage** measurement blocks.

Delay Cost

0.01

## Delay Cost

A decimal notation input button that sets a user-defined, time cost value(in units of seconds) for the compiler's test optimization function. This button is a compiler directive that incorporates the input as the expected time delay incurred when executing state changes typically related to the device under test. When placed in a test panel, the time cost information is added to the known instrument state change timing information. This is used by the compiler to prioritize test order and test execution of all test panels within the test section in order to achieve optimum test speed. A larger **Delay Cost** input value denotes a longer state change time and higher time cost associated with all of the state changes in the panel. The optimizer will seek to minimize changes to all of the states found within a panel with a large time cost across all of the tests found in the same test section.

Delay Settling

0.01

## Delay Settling

A decimal notation input button that sets the settling time(in units of seconds) for the state of an entire test panel. This button is a compiler directive that adds a user-defined delay after all of the instrument and device state changes have been executed.

Trigger Ref

0

## Trigger Ref

A decimal notation input button that marks the preceding button in a pre measure sequence as the time reference event for the **Trigger Spacing** button, offset by the value entered. The input value is in units of seconds with 1 microsecond resolution. A positive input value offsets the trigger time reference later in time from the start event reference by the input value. A negative input value moves the trigger time reference earlier than the start event reference by the input value.

This button is used with time-based measurements such as **Voltage vs Time**, **Current vs. Time**, **Triggered Voltage**, and **Triggered Digitizer** measurement blocks.



**Test Type**

standard

**Test Type**

A drop down list button that when placed in a test panel, defines the order of priority of the test panel relative to other test panels in the same test section. The Test Type button is a compiler directive that informs the optimizer if or when the test panel measurements occur within a test section:

The ‘standard’ option is the system default setting that allows the compiler’s test optimizer to decide the order of test panels within the test sections based on an time cost analysis of state changes.

The ‘first’ option designates that the measurements in the associated test panel should be executed before all other test panels within the same test section.

The ‘last’ option designates that the measurements in the associated test panel should be executed after all other test panels within the same test section.

The ‘calculation’ option designates that there are no measurements in the associated test panel, and forces the test optimizer to execute the panel as a calculation operation. Typically this is used in test panels where mathematical, algorithmic, data type conversion, and/or data save operations of local variables and data saves are executed. The function of the ‘calculation’ option of the **Test Type** button is identical to the **Calculation Only** block.

*NOTE: Instrument sweeps used as indices for extracting data values from variable arrays or data saves within designated calculation panels do not act on the instrumentation, i.e - instrument sweeps for indexing purposes do not incur any test time impact.*

**Do If True**

none

**Do If True**

A drop down list button that compiles and executes a test section, test panel, or lock step group during test plan run time if the selected symbol value is non zero (logical true). This button enables additional tests and/or measurements to be compiled and executed depending on the logic condition (value) of a user-defined symbol.

To select the symbol to be used for the logic argument, left-click within the parameter field and select the desired symbol from the pop-up list.

*NOTE: A symbol can be created from the Set Symbol button or from creating/activating a symbol table from the test plan menu options: ‘Options’>‘Edit Symbol’.*

To execute a test section upon a true symbol condition with multiple test panels, place the **Do If True** button in the Conditional Statement of a test section.

To execute a single test panel upon a true symbol condition the **Do If True** button can be placed anywhere within the desired test panel.

To execute an additional lock step upon a true symbol condition with multiple test panels, place the **Do If True** button within the Lock Step group of buttons and measurement.

Self Cal

Precompile

## Self Cal

The Self Cal button is hard coded to the Precompile condition as the test system's default and only setting. Before a compile is executed, the test system performs a self calibration of instruments that contain thermally sensitive components. This self calibration measures and corrects any thermal drift offsets prior to test execution.

## PANEL: INPUT OUTPUT STATE

Freq Reference

none

### Freq Reference

A drop down list button that selects an Instrument as the frequency index of measurements when using virtual instruments such as the Vector Network Analyzer or Noise Figure Meter. By default, all measured data is referenced/indexed by the instrument frequency designated as the input with the Input button of the virtual instrument. This button allows the user to select another instrument as the frequency index reference. This button is typically used with the **Input Freq Offset**, **Input Freq Scale**, **Output Freq Offset**, and **Output Freq Scale** buttons.

*NOTE: Only instruments active in the test system are available in the Freq Reference drop down list.*

Input Freq Offset

0

### Input Freq Offset

A decimal notation input button that defines a constant shift or offset of the index frequency that is designated by either the **Freq**

**Reference** or virtual instrument **Input** button. The frequency units are defined by the instrument frequency parameter specified by the **Freq Reference** button. The input index frequency value is defined by the equation below:

$$IndexFrequency = FreqReference[frequency] * InputFreqScale + InputFreqOffset$$

Input Freq Scale

### Input Freq Scale

A decimal notation input button that defines a multiplier value applied to the index frequency that is designated by either the **Freq Reference** or virtual instrument **Input** button. The input index frequency value is defined by the equation below:

$$IndexFrequency = FreqReference[frequency] * InputFreqScale + InputFreqOffset$$

Out Freq Offset

### Out Freq Offset

A decimal notation input button that defines a constant shift or offset of the index frequency that is designated by either the **Freq Reference** or virtual instrument **Output** button. The frequency units are defined by the instrument frequency parameter specified by the **Freq Reference** button. This button is typically used in applications

to define a frequency index for measurements of a device under test that performs frequency translation such as an RF mixer or divider/multiplier. The Output index frequency value is defined by the equation below:

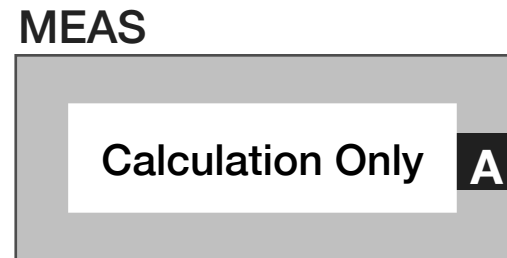
$$IndexFrequency = FreqReference[frequency] * OutputFreqScale + OutputFreqOffset$$

Out Freq Scale

### Out Freq Scale

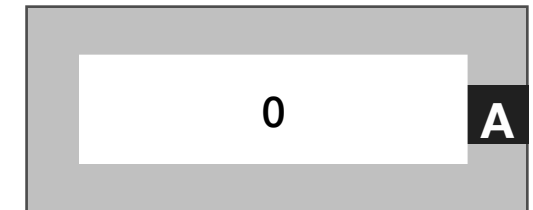
A decimal notation input button that defines a multiplier value applied to the index frequency that is designated by either the **Freq Reference** or virtual instrument **Output** button. The frequency units are defined by the instrument frequency parameter specified by the **Freq Reference** button. This button is typically used in applications to define a frequency index for measurements of a device under test that performs frequency translation such as an RF mixer or divider/multiplier. The Output index frequency value is defined by the equation below:

$$IndexFrequency = FreqReference[frequency] * OutputFreqScale + OutputFreqOffset$$

**PANEL: GENERAL CALCULATIONS****Meas: Calculation Only**

This block is a compiler directive that designates the panel as a calculation only panel, i.e - there are no measurements in the associated test panel. This block forces the test optimizer to execute the panel as a calculation operation, using instrument button settings or sweeps as index parameters only. Typically this block is used in test panels where mathematical, algorithmic, data type conversion, and/or data save operations of local variables and data saves are executed. The function of the **Calculation Only** block is identical to the **Test Type** button with the 'calculation' option selected.

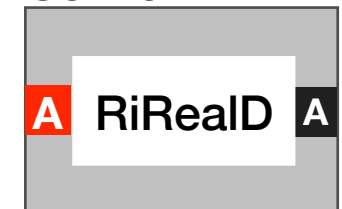
*NOTE: Instrument sweeps used as an index for extracting data values from variable arrays or data saves within designated Calculation Only test panels do not act on the instrumentation, i.e - instrument sweeps for indexing purposes do not incur any test time impact.*

**Constant****Constant**

A calculation block that outputs a user-defined, fixed numerical value. It is typically used as an input to arithmetic functions and/or logic arguments. The value of a constant is defined by right-clicking within the gray area of the block and selecting 'Default...' from the pop-up menu list.

Data Type Information

The data type of the constant value can be defined by right-clicking within the gray area of the block and selecting 'DataType...' from the pop-up menu list. The unit scaling options can be defined by right-clicking within the gray area of the block and selecting 'Units Scale' from the pop-up menu list.

**Convert****Convert**

A one-input calculation block that converts the data type of measurements or calculation data that is supplied to the input of the

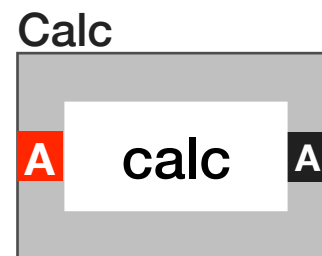
block (red A on left side). The converted data is supplied to subsequent measurement, local variable, or data save blocks by connecting the output of the block (black A on left side).

To set the conversion data type, connect the input of the Convert block to a measurement, local variable output block, or calculation block. Right-click within the gray area of the block and select 'DataType...' from the pop-up menu list.

## Calc

The one input calculation block performs arithmetic operations on data provided by a single measurement or data output block. The calculation options are defined by the measurement block that is connected to the input of the block (red A on left side). The output data from the **Calc** block can be connected to multiple downstream operations or data/variable saves.

To select a calculation option for a given data type, connect the measurement data or variable output block to the **Calc** input. Once connected, right-click on the **Calc** block and select 'Calculation' from the menu. The calculation operations available for the given data type are provided in the calculation window list.



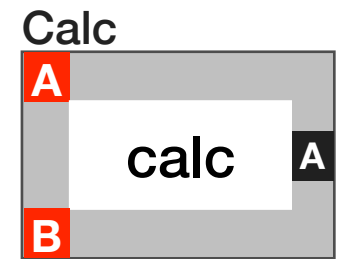
*NOTE: The data type of the values supplied to the input of the Calc block is displayed at the top of the calculation window.*

## Calc (Two Input)

The two-input calculation block performs arithmetic operations on data provided by two measurement or data output blocks. The calculation options are defined by the measurement or data output block connected to the 'A' input of the block (red A on left side). The output data from the **Calc** block can be connected to multiple downstream operations or data/variable saves.

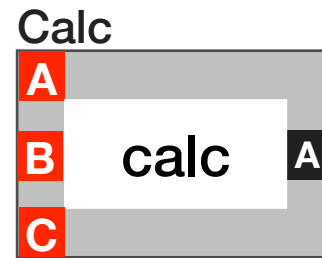
To select a calculation option for a given data type, connect the measurement or data output blocks to the **Calc** buttons inputs. Once connected, right-click on the **Calc** block and select 'Calculation' from the menu. The calculation operations available for the given data type are provided in the calculation window list.

*NOTE: The datatype and by extension the calculation options of the two-input calc block are defined by the data source connected to the 'A' input.*





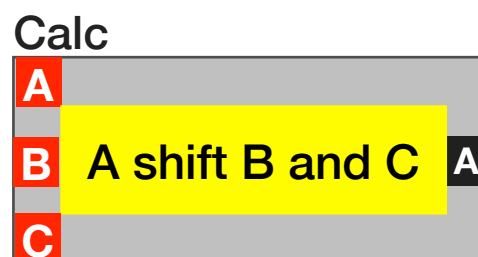
## Calc (Three Input)



The three-input calculation block performs arithmetic operations on data provided by three measurement or data output blocks. The calculation options are defined by the measurement or data output block connected to the 'B' input of the block (red B on left side). The output data from the **Calc** block can be connected to multiple downstream operations or data/variable saves.

To select a calculation option for a given data type, connect the measurement or data output blocks to the **Calc** buttons inputs. Once connected, right-click on the **Calc** block and select 'Calculation' from the menu. The calculation operations available for the given data type are provided in the calculation window list.

*NOTE: The datatype and by extension the calculation options of the three-input calc block are defined by the data source connected to the 'B' input.*



A Shift B and C

A specialized three-input calculation block that performs a binary shift operation followed by a logical AND operation. It is used to extract individual or groups of bits from a larger bit string. Data bits from a **Serial Read** measurement block connected to the 'B' input are shifted by the number of bits specified by the 'A' input (typically a **Constant** output block) and then logically AND'd with a bit mask connected to the 'C' input (typically a **Constant** output block) to truncate the bit string. The 'A' and 'C' inputs are expressed in decimal form.

### To create the A Shift B and C calculation block:

1. Place a three-input calculation block in a test panel.
2. Right click within the gray area of the block and select **Edit Block...** from the menu options.
3. In the Block Edit window enter the following code:
 

```
[ :a | (RiRealD fromFloat: (((a at:1)
asInteger) bitShift: (((a at:2) asFloat)
rounded negated)) bitAnd:(((a at:3) asFloat))
rounded asInteger))]
```
4. From the Block Edit menu option select **Save > Save**
5. In the Enter Button Text window, the user can input a block name, i.e. 'A shift B and C' and click **OK**.

6. In the Select Data Type window select 'RiRealD' from the list to output the result as a decimal value and click **OK** to complete the calculation block.

*NOTE: The calculation block will change to a yellow color to indicate a custom function.*

Set Symbol X

0.0

## Set Symbol

A decimal notation input button that sets the value of a user-specified symbol. This button can be used to create a symbol and set its value within the global defaults, section defaults, or a test panel. Multiple instances of the same **Set Symbol** button name can be used in a test plan. A **Set Symbol** button in a test panel will override the symbol value in the section defaults, global defaults, and/or symbol table.

The **Set Symbol** button defaults to a symbol name of 'X'. The symbol name can be changed by right-clicking on the button and selecting 'Symbol Name...' from the pop-up menu list. From the name prompt, a new symbol can be created by entering the name in the empty field. A previously defined symbol value can be changed from by selecting 'Cancel' in the name prompt and selecting from the list of symbols.

### Data Type Information

The data type of the symbol value can be defined by right-clicking on the button and selecting 'DataType...' from the pop-up menu list. The unit scaling options can be defined by right-clicking within the gray area of the block and selecting 'Units Scale' from the pop-up menu list.

Var Prompt

X

## Var Prompt

A decimal notation input button that creates a user prompt with an input field, and stores the user input value to the specified variable during test plan execution. This button is used to create a new variable and set its value within a test panel.

The variable name can be changed by right-clicking on the button and selecting 'Var Name...' from the pop-up menu list.

The text visible in the user prompt can be defined by right-clicking on the button and selecting 'Prompt Text...' from the pop-up menu list.

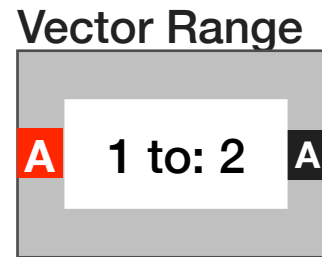
*NOTE: During test plan execution, the operator must select 'OK' (press enter) in the prompt for the test program to continue.*

### Data Type Information

The data type of the variable can be defined by right-clicking on the button and selecting 'DataType...' from the pop-up menu list.

## Vector Range

A calculation block that outputs a subset of a single connected data output block with indexed data values such as arrays, index by variables, instrument state sources, and/or calibration data. The index range can be specified by the user by setting the start and stop indices of the vector range desired: Right-click within the gray area of the block and select 'Start Index' to select the initial value and select 'Stop Index' to select the final value of the index range.



## TEMPTRONICS TP04310A TEMPERATURE CONTROLLER

*PANEL: TEMPERATURE*

Test Plan Controlled

no

### Test Plan Controlled

A drop down list button to set to 'yes' if used within the Test Plan. Use to quickly disable all temperature operations, useful for debugging.

Temperature

20

### Temperature

A decimal notation input button with units in °C to set the Temperature. Use the **Soak** and **Max Error** buttons to control the time needed before testing continues.

Head

up

### Head

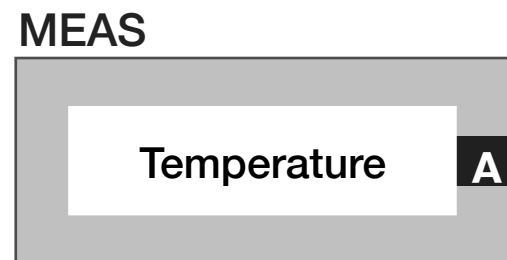
A drop down list button to raise or lower the ThermoStream head.

## Flow



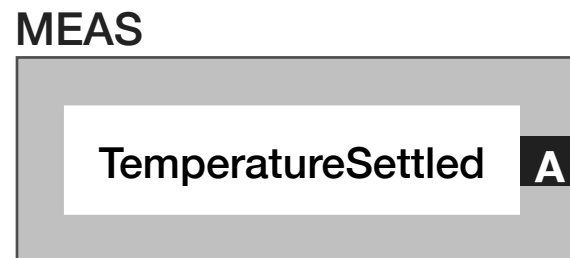
A drop down list button to set air flow to on or off.

## Meas: Temperature



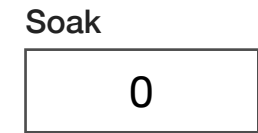
A measurement block that outputs the measured temperature in °C.

## Meas: TemperatureSettled



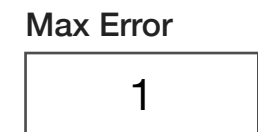
A measurement block that sets the time in seconds to wait until the temperature is within MaxError, then wait the number of seconds specified by the **Soak** button.

## Soak



A decimal notation input button to set a wait time in units of seconds once the temperature set by the **Temperature** button is reached.

## Max Error



A decimal notation input button to set the temperature error in °C at which **Soak** time starts.

## RI8568X CASSINI 16 SLOT TESTER

### PANEL: STATE

---

The 'Tester' instrument provides power supplies for the fixtures. These buttons are used to control the power supplies for fixture modules or supply voltage to additional instrumentation internal to the fixture or present on the device interface board PCB.

Fixture 28v

off

### Fixture 28v

A drop down list button to control the 28 V supply to the fixture. This supply provides voltages to drive additional RF switches, relays, etc. added to the internal of the fixture or device interface board PCB. The supply provides voltage through the fixture's RIFL interface to the fixture carrier board.

The 'on' setting provides  $\pm 5$  volt and  $\pm 15$  volt supplies to the fixture.

The 'off' setting provides sets the supplies to 0 volts.

---

**WARNING: There is a risk of electrical shock if there is no fixture installed on the test head when the Fixture 28v is set to 'on' in a test plan. The Fixture 28v button should be left in the default**

**setting of 'off' or removed from test plans if no fixture is installed on the test head.**

---

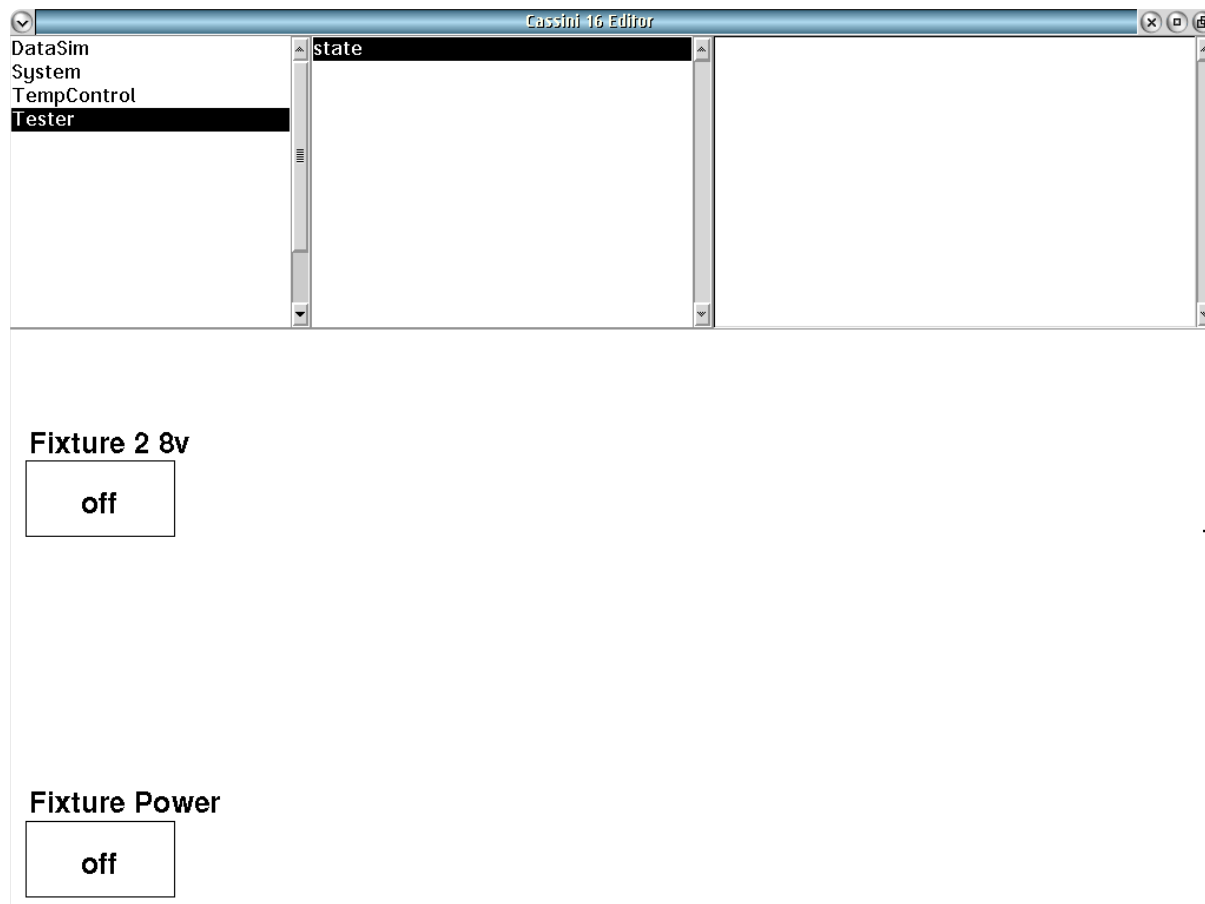


## Fixture Power

Fixture Power

off

## EDIT PANELS 15 RI8574: SYSTEM CONTROLLER



Tester **state** panel shows fixture power states.

A drop down list button to control the  $\pm 5$  V and  $\pm 15$  V supplies to the fixture. The fixture supply provides voltage through the fixture's RIFL interface to the fixture carrier board to power on fixture modules.

The 'on' setting provides  $\pm 5$  volt and  $\pm 15$  volt supplies to the fixture.

The 'off' setting provides sets the supplies to 0 volts.

---

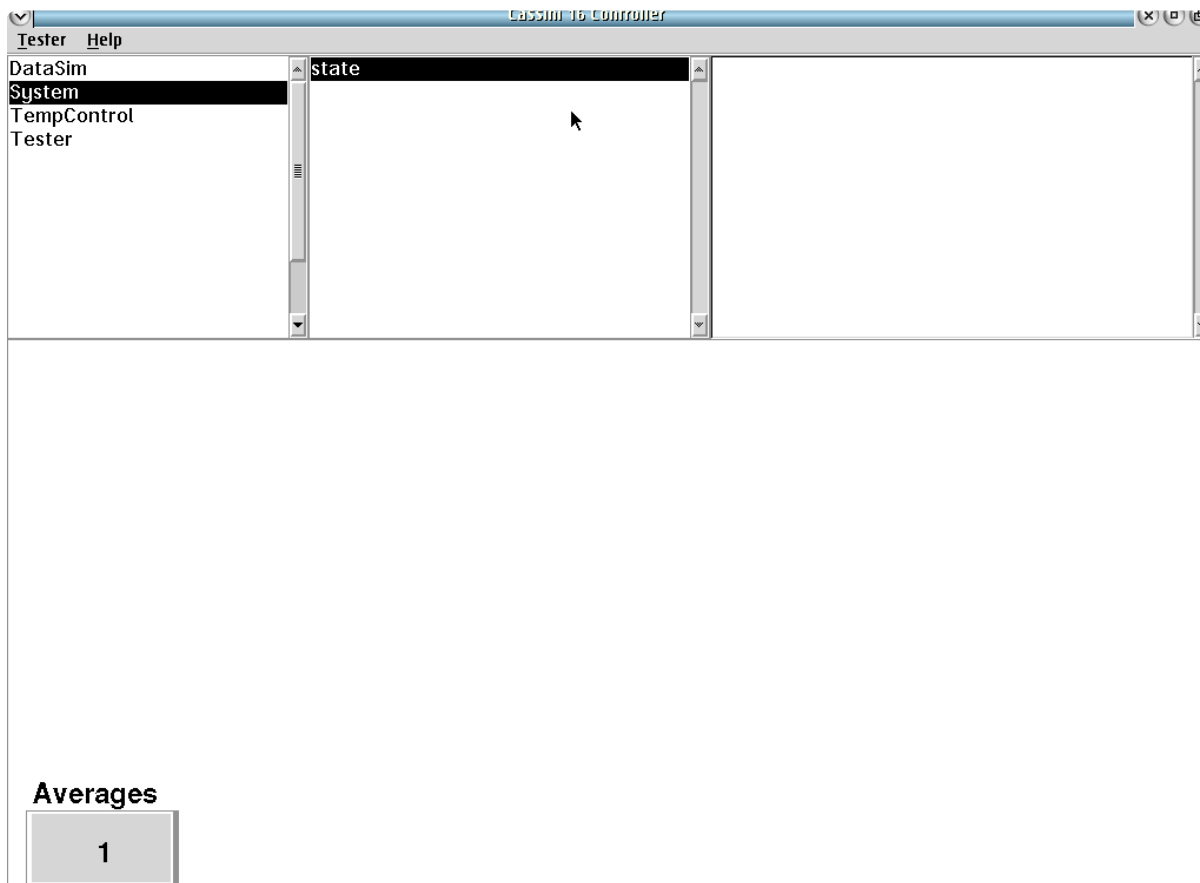
**WARNING: There is a risk of electrical shock if there is no fixture installed on the test head when the Fixture 28v is set to 'on' in a test plan. The Fixture 28v button should be left in the default setting of 'off' or removed from test plans if no fixture is installed on the test head.**

---

## CONTROL PANELS

Real-time control of the instruments in this TIM. Most buttons behave exactly like described in the Edit Panel. Only controls that are not included in the Edit panel are listed in this section.

### CONTROL PANELS 10 RI8574: SYSTEM CONTROLLER



System **state** button provides real-time control over the number of averages measurements take.



## SYSTEM

### STATE PANEL

#### Averages

Many measurements support averaging. Use this button to set the averaging factor.

## TEMPCONTROL

### CONTROL PANEL

#### Temperature

Measure the current temperature in °C. (Read Only)

# RI8575: PHASE NOISE MEASURE



## TOPICS

---

[Instruments Provided by this TIM](#)

[Instrument Diagram with Edit Buttons](#)

[Edit Panel Button Descriptions](#)

[Control Panel](#)

Tap the links above to quickly access content

## INSTRUMENTS PROVIDED BY THIS TIM

The instrument in this TIM appear as **PhaseNoiseAnalyzer** in the panel dialog windows.

Model and Name as it appears in the Tester Configuration:

- PhaseNoiseAnalyzer, RI8575x 1 - 16 GHz Phase Noise Analyzer

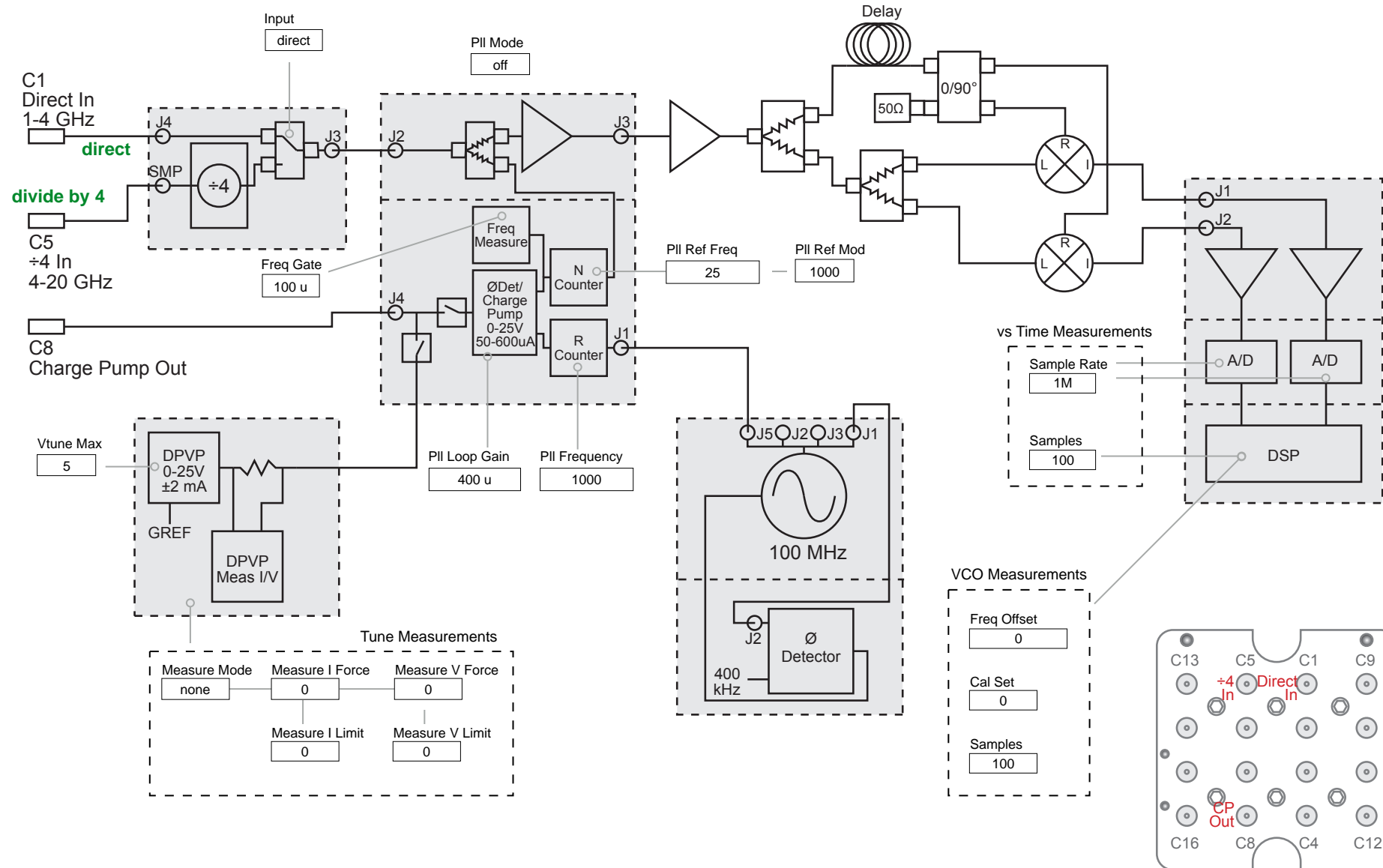
*NOTE: Multiple RI8575 instruments are enumerated incrementally by the system as “2”, “3”, etc. in the configuration, edit, and control panels (i.e - PhaseNoiseAnalyzer, PhaseNoiseAnalyzer2, PhaseNoiseAnalyzer3, etc). The “x” in RI8575x denotes the model revision number.*

# INSTRUMENT BUTTON DIAGRAM 2.9

Roos Instruments, Inc - Cassini  
 Block Diagram, Phase Noise Discriminator TIM  
 RI8575A

2012-03-21  
 Copyright Roos Instruments, Inc.  
 Subject to change without notice

Tap for Zoom View

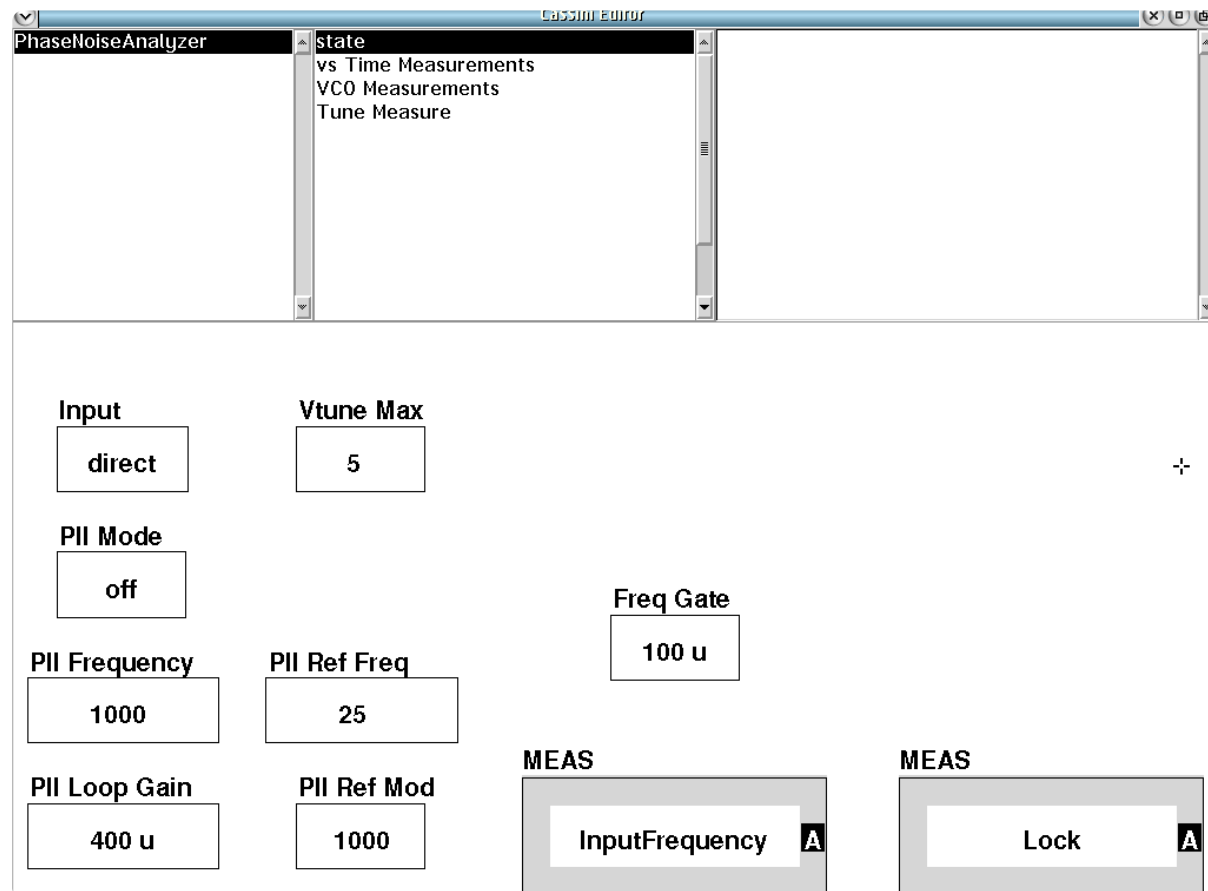




## EDIT PANELS

Automated control of the instruments in this TIM with use by the Test Plan Editor.

### EDIT PANELS 16 RI8575: PHASE NOISE MEASURE



PhaseNoiseAnalyzer **state** panel shows state and measurement buttons for the instrument in this TIM.



### PANEL: STATE

PII Frequency

1000

### PII Frequency

A floating-point input button with units of MHz that defines the lock frequency of the DUT. If the frequency range is between 800 MHz to 4000 MHz, set the **Input** button to the 'direct' setting. If the frequency range is between 2000 MHz to 4000 MHz, set the **Input** button to the '/4' (divide by 4) setting. The **PII Ref Freq** button (internal reference oscillator frequency) must also be set to correspond with the expected frequency from the DUT. The ratio of the **PII Frequency** value to the **PII Ref Freq** value sets the *N Counter*. The value of the **PII Ref Mod** button defines the allowable fractional component of the *N Counter* and thus the resolution of the lock frequency.

*NOTE: The frequency resolution of an input to the Direct port is defined as: Pll Ref Freq / Pll Ref Mod*

*The frequency resolution of an input to the ÷4 Port (C5) is defined as: (Pll Ref Freq / Pll Ref Mod) × 4*

**PII Ref Freq**

25

**PII Ref Freq**

A integer value input button that sets the reference frequency of the phase detector for the internal reference PLL in units of MHz. This reference value sets the R Counter parameter in the phase lock circuitry of the internal reference PLL. The R counter provides 100 MHz signal. This R counter drives a frequency divider for adjusting the locking value to match the DUT's using the formula:  $100 \text{ MHz} \div R$ . The range of R is 4 to 1023. This allows a maximum frequency value of 25 MHz. When **PII Mode** is set to 'count', the **PII Frequency** and **PII Ref Freq** buttons are used to set the N Counter.

*NOTE: It is recommended that the Pll Ref Freq button be set to 25 MHz when Pll Mode is set to 'count' mode.*

**PII Ref Mod**

1000

**PII Ref Mod**

An integer data input button with units of MHz that sets the fractional modulus from 0 to 4095. This button is used with the **PII Frequency** and **PII Ref Freq** buttons to define the frequency locking and phase synchronization of the DUT with the internal reference PLL.

**PII Loop Gain**

400 u

**PII Loop Gain**

A floating-point input button that sets the phase detector current gain with units of Amps. The maximum current value is 625uA and the minimum value is 10uA. The loop gain is primarily a function of the external loop filter and the DUT VCO's kV. This button is used with the **Vtune Max** button.

**PII Mode**

off

**PII Mode**

List select button that sets the function of the internal PLL and measure instruments.

The 'off' setting disconnects the RF input paths from the phase detector and charge pump. This mode is useful when using the parametric measure capability (DPVP Meas I/V) for leakage current measurements.

The 'lock' setting activates the PLL's phase detector and connects the charge pump to the *Charge Pump Out (C8)* port to phase lock the input source for measurements using the phase noise discriminator.

The 'count' setting activates the frequency counter/measure function of the PLL. This setting is commonly used with the **Measure Mode**

button to capture tuning voltages with the parametric measure (DPVP Meas I/V) on the *Charge Pump Out (C8)* port.

The ‘Disc’ setting is the ‘discriminator only’ mode which disconnects the charge pump from the *Charge Pump Out (C8)* port and disables the phase detector to measures phase noise with the phase discriminator without phase locking the DUT.

### Input

Drop-down list button that selects either the *Direct In 1-4GHz (C1)* or *÷ 4 4-20 GHz (C5)* RF input ports to the phase detector and PLL locking loop. The ‘direct’ value routes the *Direct In 1-4 GHz Input (C1)* port to the phase lock loop. The ‘/4’ value routes the *÷ 4 4-20 GHz (C5)*.

This button is commonly used with the **Pll Mode**, **Pll Ref Freq**, **Pll Frequency**, **Pll Ref Mod**, and **Vtune Max** buttons.

*NOTE: The ‘Direct In’ port supports frequencies from 800 MHz to less than 4 GHz and the ‘÷ 4’ port supports frequencies from 4 GHz to 20 GHz with -5 dBm to +10 dBm typical performance.*

Input

direct

Freq Gate

100 u

### Freq Gate

Integer value button that sets the frequency counter/measure instruments capture time in seconds. The frequency counter depth is 16 bits. The frequency resolution in Hz is defined as:

$$(1 \div \text{Freq Gate}) \times (\text{Pll Frequency} \div \text{Pll Ref Freq})$$

The maximum **Freq Gate** value is:

$$(\text{Pll Frequency} \div \text{Input Frequency}) \times (1 \div \text{Pll Ref Freq})$$

*NOTE: If the input frequency and Pll Ref Freq button value are set to the recommended 25 MHz, the Maximum Freq Gate value is 2.6 msec.*

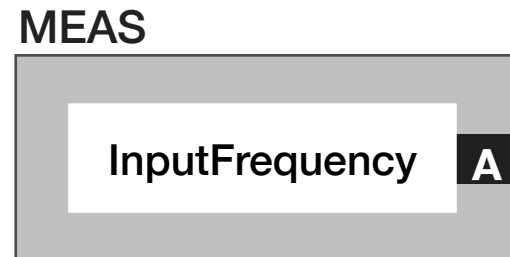
Vtune Max

5

### Vtune Max

Floating-point button that sets the upper limit or maximum value of the drive voltage for tuning the DUT frequency. This setting provides a voltage upper limit clamp to prevent the *DPVP 0-25V ±2mA* supply from exceeding the DUT’s supply or rail voltage. The maximum voltage value is 25 volts and minimum is 5 volts.

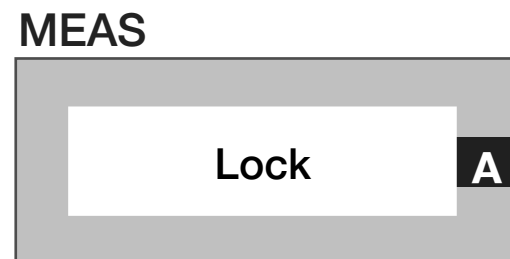
This button is commonly used with the **PII Mode** button in the 'lock' setting with the **Input**, **PII Ref Freq**, **PII Frequency**, **PII Ref Mod** buttons.



**Meas: Input Frequency**

Measurement block that calculates the input frequency in MHz. This block is only valid with a **PLLFrequency** button set to the maximum expected frequency.

The **PIIMode** button can be set to count for unlocked measurements or lock if the **MeasureMode** button is not set to 'none.'



**Meas: Lock**

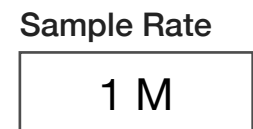
Measurement block where the result is a floating point value of 1.0 if the loop is locked (true). This block is only valid in **PII lock** mode when the **MeasureMode** button is set to 'none'.

**PANEL: VS TIME MEASUREMENTS**



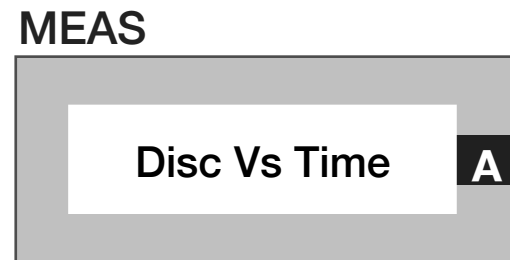
**Samples**

Integer value button that sets the number of samples to use in a phase measurement with the discriminator. The maximum value is 1024. Together with the **Sample Rate** button, this button defines the total measurement time for **Noise Vs Time** and **Tune Voltage Vs Time** measurement blocks.

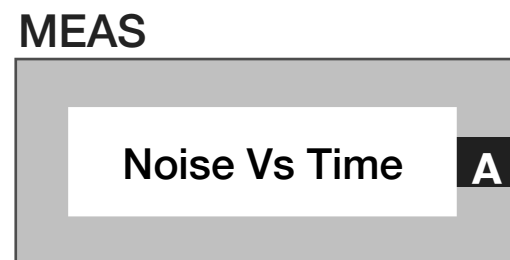


**Sample Rate**

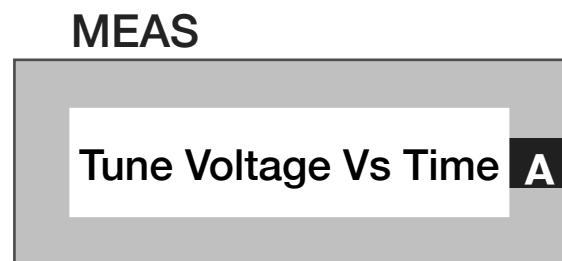
Decimal notation input button that sets the sample rate for phase measurements with the discriminator in Hertz. The maximum sample rate is 40 MHz. Together with the **Sample Rate** button, this button defines the total measurement time for **Noise Vs Time** and **Tune Voltage Vs Time** measurement blocks.

**Meas: Disc Vs Time**

Measurement block that calculates the DC output of the discriminator. Used to get carrier frequency information.

**Meas: Noise Vs Time**

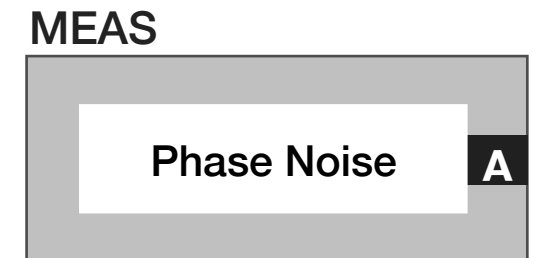
Measurement block that computes the AC output of the discriminator. It is used for raw FM measurements.

**Meas: Tune Voltage Vs Time**

Measure block that computes the tune voltage. The **Measure Mode** button must be set 'Meas V' to capture voltage values on the *Charge Pump Out (C8)* tune line.

**PANEL: VCO MEASUREMENTS****Meas: Sideband**

The measurement block assumes a FM tone sideband and gives the ratio of the sideband power to the carrier power. The measured value is a one sided calculation of the carrier as seen on a spectrum analyzer and is  $B/2$ .

**Meas: Phase Noise**

Discriminator power measurement adjusted for offset frequency in dBc/hz. The result is a one sided calculation similar to the measurement computed on a spectrum analyzer.

**Freq Offset**

Integer value button that sets the frequency offset in units of Hertz for the DSP mixer.

Freq Offset

0

**Samples**

Integer value button that sets the number of samples used in a measurement. For DSP measurements this is the number of averages. The maximum value for VCO measurements with the DSP is 3000 samples.

Samples

100

**Cal Set**

Local variable input button used for RI internal purposes only.

Cal Set

0

**PANEL: TUNE MEASURE**

Measure Mode

none

**Measure Mode**

Drop down list button that select the mode of the *Charge Pump Out (C8)* port.

Drop down list button that sets the mode of the precision measure instrument (*DPVP Meas I/V*).

The 'none' selection disconnects the precision measure resource from the *Charge Pump Out (C8)* port.

The 'Meas I' selection forces a voltage defined by the **Measure V Force** button and measures on the *Charge Pump Out (C8)* port. The **Measure I Limit** button restricts the maximum amount of current delivered by the supply (*DPVP 0-25V, ±2 mA*) during the measurement to avoid damaging the device pin if there is a DUT failure.

The 'Meas V' selection forces a current defined by the **Measure I Force** button and measures the resulting voltage on the *Charge Pump Out (C8)* port. The **Measure V Limit** button restricts the maximum voltage applied by *DPVP 0-25V, ±2 mA* during the measurement. Typically the **Measure V Limit** button is set to the DUT's supply rail or ground depending on the polarity of the **Measure I Force** button to avoid damaging the device pin.



*NOTE: This mode is typically used for continuity tests or testing protection diodes on DUT pins.*

The 'Leakage' selection measures the current on the *Charge Pump Out (C8)* port. This mode sets the precision measure's sense resistor to it's lowest current measurement range and incorporates a built-in, recursive averaging method to measure DC leakage currents in the pA range. Leakage forces voltage with a 50u max current.

*NOTE: This mode can be used in continuity tests for device pins with large in-rush currents or long duration time constants during power up.*

The 'Leak Cal' selection is the same mode as the 'Meas I' mode with the exception that the voltage limit settings are deactivated. The value set with the **Measure V Limit** is ignored, and the supply(DPVP 0-25V,  $\pm 2$  mA) will provide as much available voltage as possible to force the current condition defined by the **Measure I Force** button.

*NOTE: Use caution with this mode, as pin voltages can exceed the rail voltages of the device under test.*

**Measure I Force**

0

### Measure I Force

Force current in iMeas mode. Max is 2 mA.

**Measure V Force**

0

### Measure V Force

Force voltage in Force V mode. Range is -2 to +25 volts.

**Measure V Limit**

0

### Measure V Limit

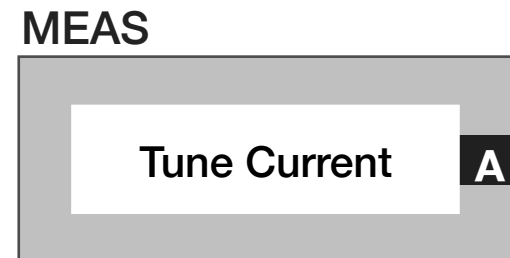
Voltage limit in I Force mode. Range is 0 to 25 volts

**Measure I Limit**

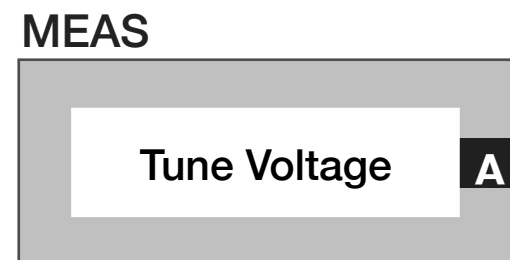
0

### Measure I Limit

Current limit in vMeas mode. Max is 2 mA.

**Meas: Tune Current**

Measure the current on the tune line. Range is  $\pm 2$  mA or  $\pm 50\mu\text{A}$  in leakage mode. When not in leakage mode then setting Measure I Limit to less than  $500\mu\text{A}$  selects a finer resolution.

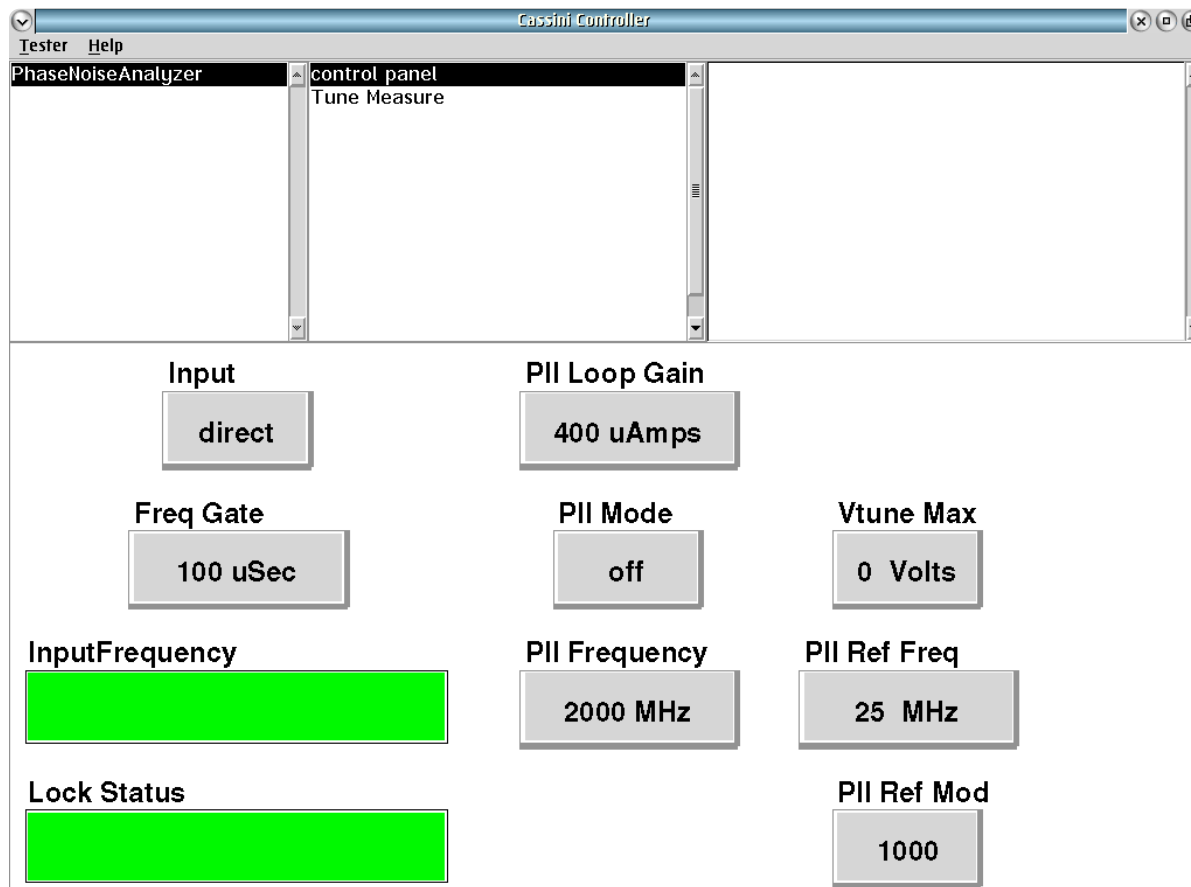
**Meas: Tune Voltage**

Measure the voltage on the tune line. Range is -3v to + 25v

## CONTROL PANELS

Real time control of the instruments in this TIM.

### CONTROL PANELS 11 RI8575: PHASE NOISE MEASURE



PhaseNoiseAnalyzer **control panel** shows state and connection buttons for real-time control of the instrument in this TIM.

• •

## CONTROL PANEL

### InputFrequency

Displays the input frequency.

### Lock Status

Displays the lock status.

## TIME MEASURE

## VOLTAGE

Displays the Voltage.

## CURRENT

Displays the Current.

# RI8577: SOURCE COMBINER



## TOPICS

---

[Instruments Provided by this TIM](#)

[Configuration Panel](#)

[Instrument Diagram with Edit Buttons](#)

[Edit Panel Button Descriptions](#)

[Control Panel](#)

Tap the links above to quickly access content.

## INSTRUMENTS PROVIDED BY THIS TIM

The instrument in this TIM appear as **Src12Output** in the panel dialog windows. Additional TIMs appear as Src12Output# with # replaced by the number of TIM.

Model and Name as it appears in the Tester Configuration:

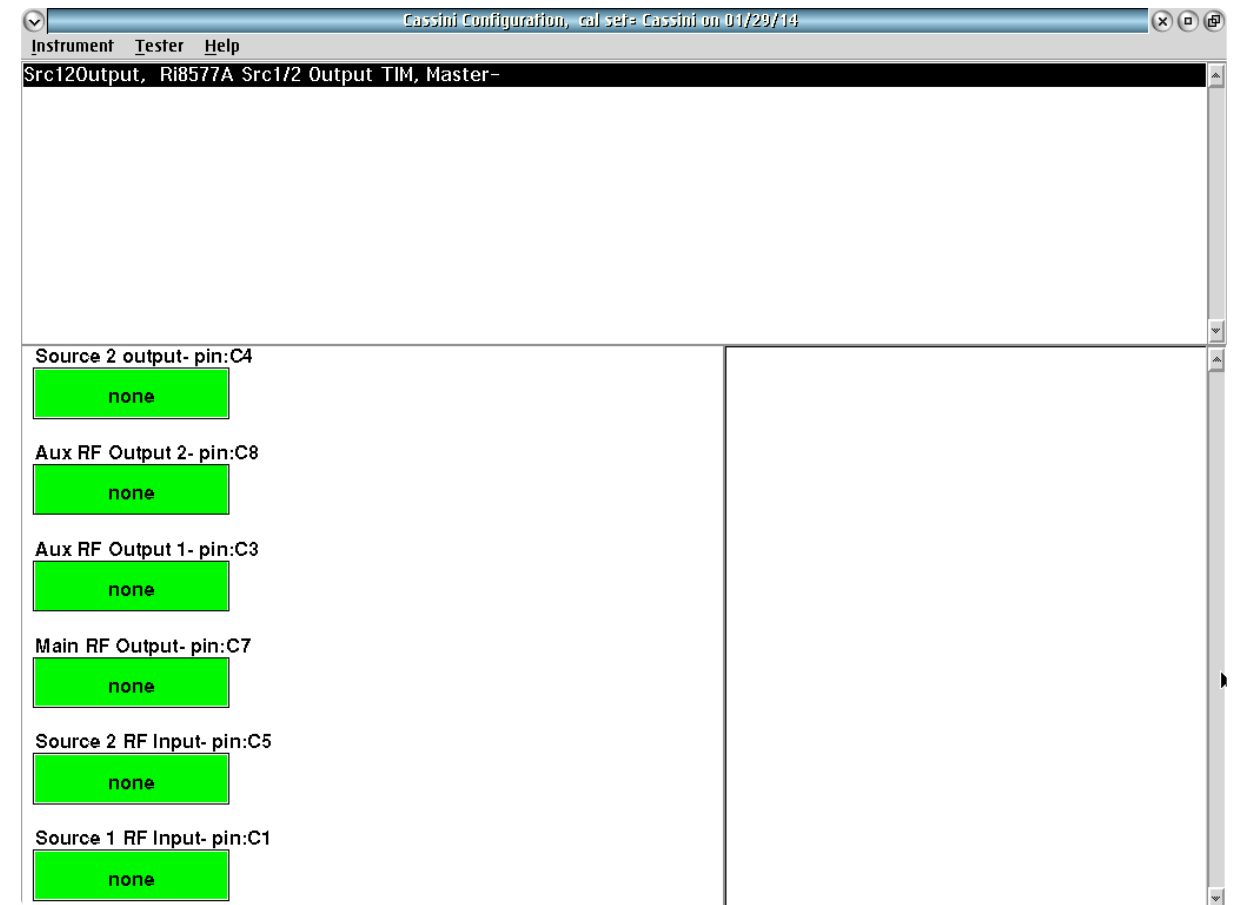
- Src12Output, Ri8577x Src1/2 Output TIM

*NOTE: Multiple RI8577 instruments are enumerated incrementally by the system as “2”, “3”, etc. in the configuration, edit, and control panels (i.e - Src12Output, Src12Output2, Src12Output3, etc). The “x” in RI8577x denotes the model revision number.*

## CONFIGURATION PANELS

All of the connection path buttons **Source1 RF Input- pin:C1**, **Source2 RF Input -pin:C5**, **Main RF Output -pinC7**, **Aux RF Output1 -pin:C3**, **Aux RF Output2 -pinC8**, and **Source2 Output -pinC4** are green because they provide connections to the Test Fixture interface. This means they must be defined by the connections that are listed in the Test Fixture definition, but are still displayed here.

## CONFIGURATION PANELS 5 RI8577: SOURCE COMBINER



Displays connection paths entering and leaving this TIM.

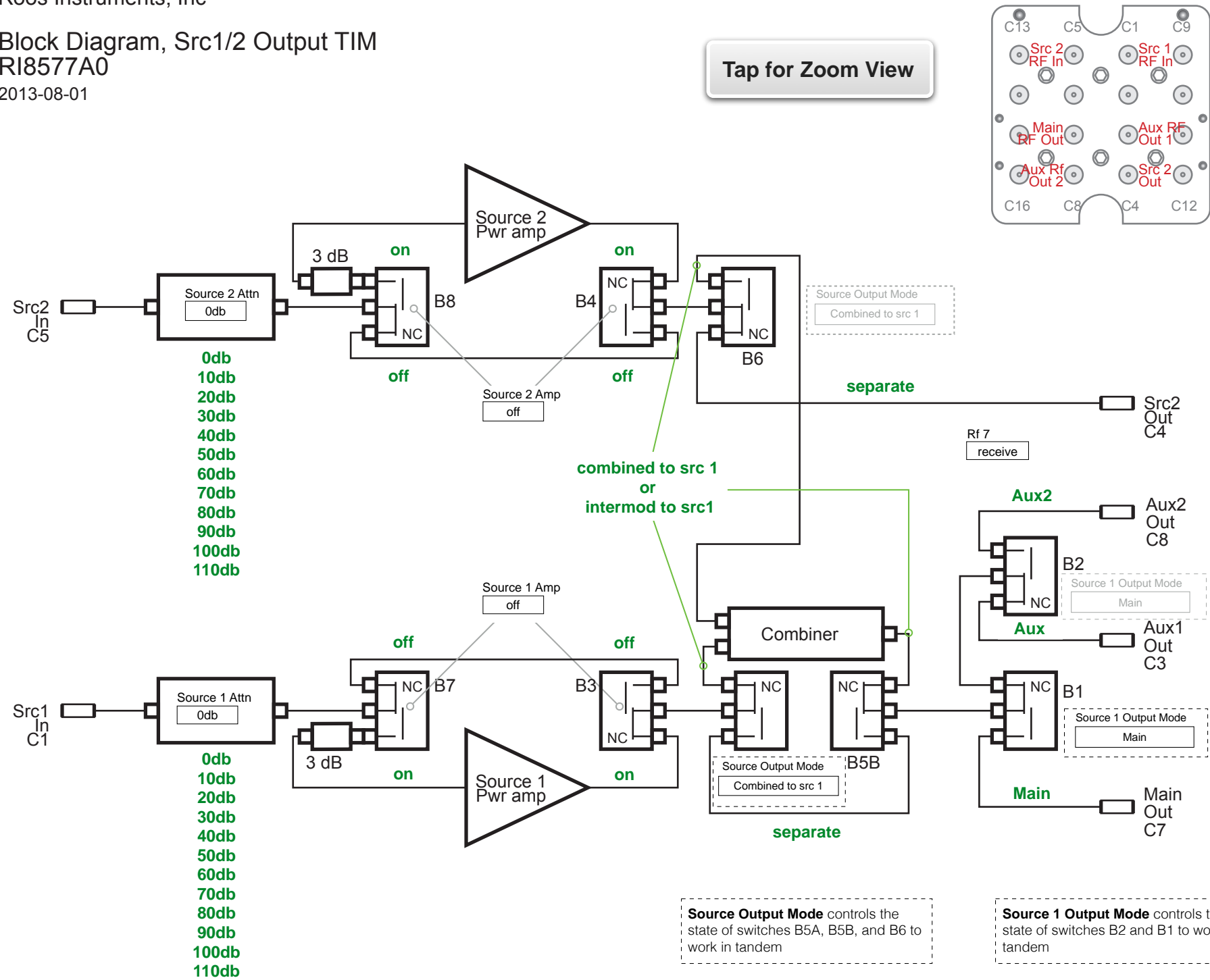


INSTRUMENT BUTTON DIAGRAM 2.10

Roos Instruments, Inc

**I** Block Diagram, Src1/2 Output TIM  
RI8577A0  
2013-08-01

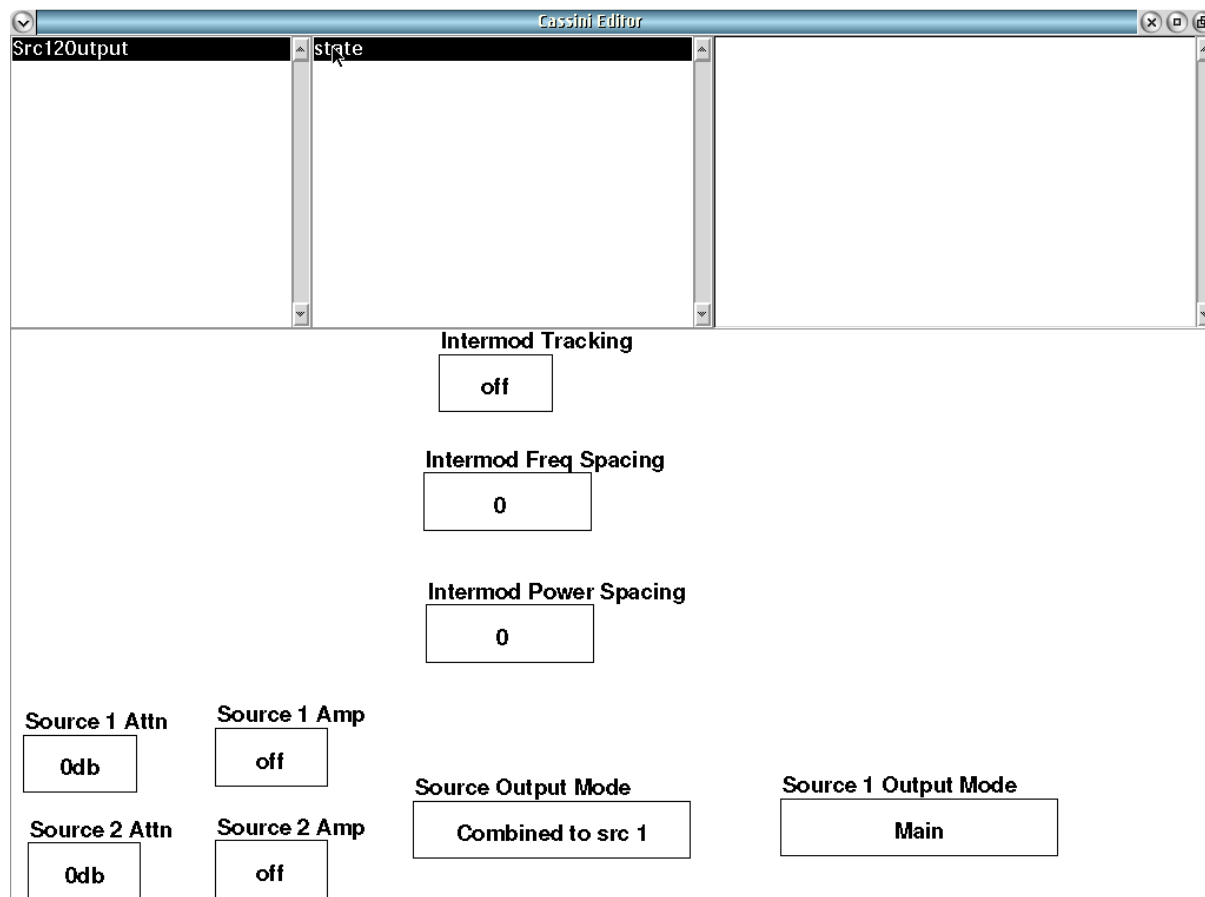
Tap for Zoom View



## EDIT PANELS

Automated control of the instruments in this TIM with use by the Test Plan Editor.

### EDIT PANELS 17 RI8577: SOURCE COMBINER



Src12Output controls the signal paths going through this instrument.

#### PANEL: STATE

Source 1 Attn

#### Source 1 Attn

A drop down list button for path 1 that switches in the steps of the 110 dB mechanical attenuator offered in 10 dB steps.

*NOTE: The "0" dB step is relative to the other steps.*

Source 2 Attn

#### Source 2 Attn

A drop down list button for path 2 that switches in the steps of the 110 dB mechanical attenuator offered in 10 dB steps.

*NOTE: The "0" dB step is relative to the other steps.*

## Source 1 Amp

A drop down list button that in the “on” state connects a 20 dB gain amp into the output path. (usable only 500 MHz to 6 GHz)

Source 1 Amp

off

## Source 2 Amp

A drop down list button that in the “on” state connects a 20 dB gain amp into the output path. (usable only 500 MHz to 6 GHz)

Source 2 Amp

off

## Intermod Tracking

A drop down list button that in the “on” state directs the compiler to use the information in the “Intermod Frequency Spacing” button, and “Intermod Power Spacing” buttons tracking and redirect the Source1 and Source 2 instruments-parameters.

Intermod Tracking

off

Intermod Freq Spacing

0

## Intermod Freq Spacing

A floating-point input button with units of MHz that sets the spacing between the two Sources to setup a Two tone measurement. Source 1 will be set above its requested frequency by 1/2 the intermod frequency spacing and Source2 will be set below the requested frequency of Source 1 was set to by the same amount. This is only valid when the Source Output Mode is set to “intermod to Src 1” mode.

Intermod Power Spacing

0

## Intermod Power Spacing

A floating-point input button with units of dB that sets the output power difference between the two Sources. Source1 is set to its requested power and Source2 is offset from that set in Source 1 by the value of the Intermod Power Spacing button. This only has effect when the Source Output Mode is set to “Intermod to src1” mode.

### Source Output Mode

A drop down list button that sets the internal source routing to be combined with a passive power combiner or still conditioned but as separate outputs.

The “separate” mode routes the Source 1 output directly to the output selected with the Source 1 Output Mode button. Source 2 is set to the Src 2 out directly.

The “Combined to src1” mode routes the two sources into a passive power combiner and then routes the combined signal to the output selected with the Source 1 Output Mode button. The Src2 output is disconnected.

The “Intermod to src1” mode again routes the two sources into a passive power combiner and then routes the combined signal to the output selected with the Source 1 Output Mode button. The Src2 output is again disconnected. In addition this mode directs the compiler to alter the values of both Source1 and Source2’s Frequency and Power output settings to take into account the values listed in the “Intermod Freq Spacing” and “Intermod Power Spacing buttons.

Source Output Mode

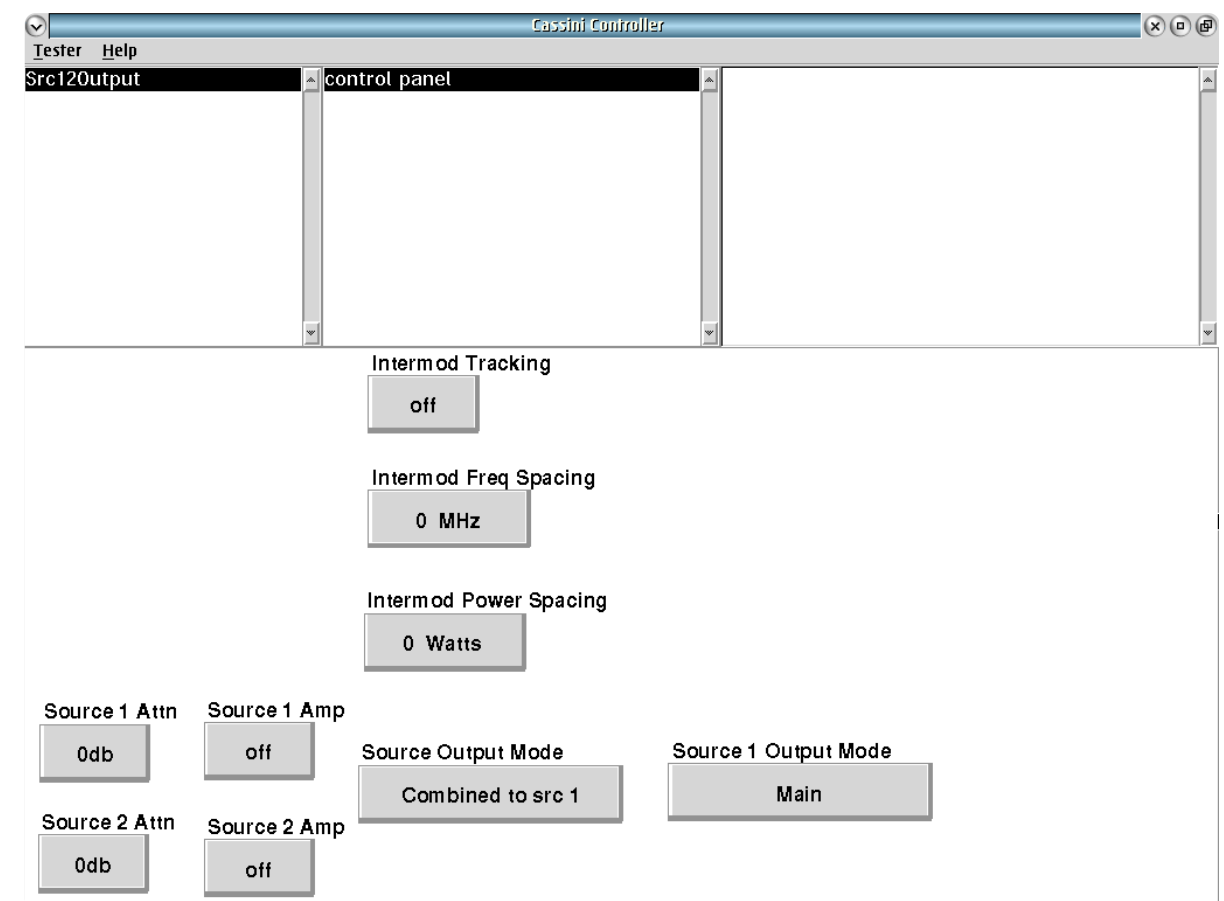
Combined to src 1

### Source 1 Output Mode

Source 1 Output Mode

Main

### CONTROL PANELS 12 RI8577: SOURCE COMBINER



Src12Output **control panel** provides real-time control of signals going through this TIM.

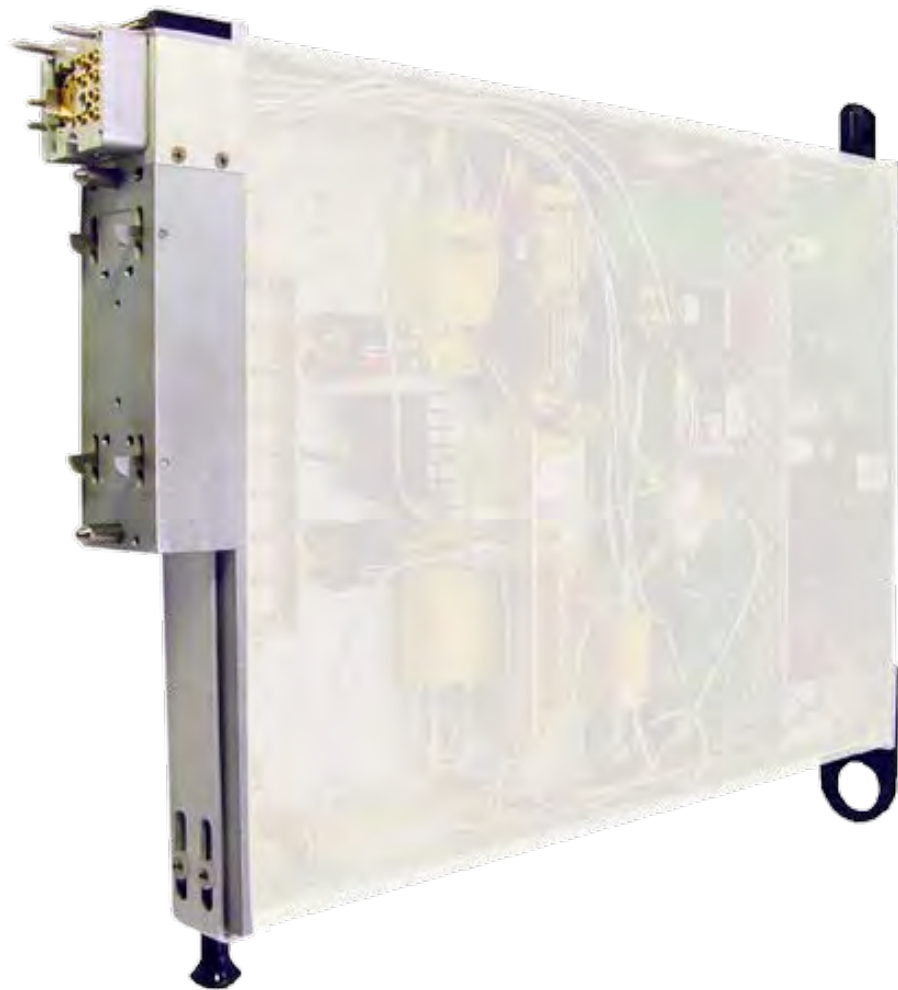
A drop down list button that sets the internal source routing to connect the output of the Source 1 path to either the “Main”, “Aux”, or “Aux2” output ports.

---

## CONTROL PANELS

Real time control of the instruments in this TIM. Please refer to the Edit Panels for help with buttons contained in both the “Edit” and “Control” panels.

# RI8580: 57GHz TO 64GHz TESTSET



## TOPICS

---

[Instruments Provided by this TIM](#)

[Edit Panel Button Descriptions](#)

[Control Panel](#)

Tap the links above to quickly access content



## INSTRUMENTS PROVIDED BY THIS TIM

The instrument in this TIM appear as **Test Head66** in the panel dialog windows.

Model and Name as it appears in the Tester Configuration:

- Test Head66, RI8580x 66 GHz Test Set

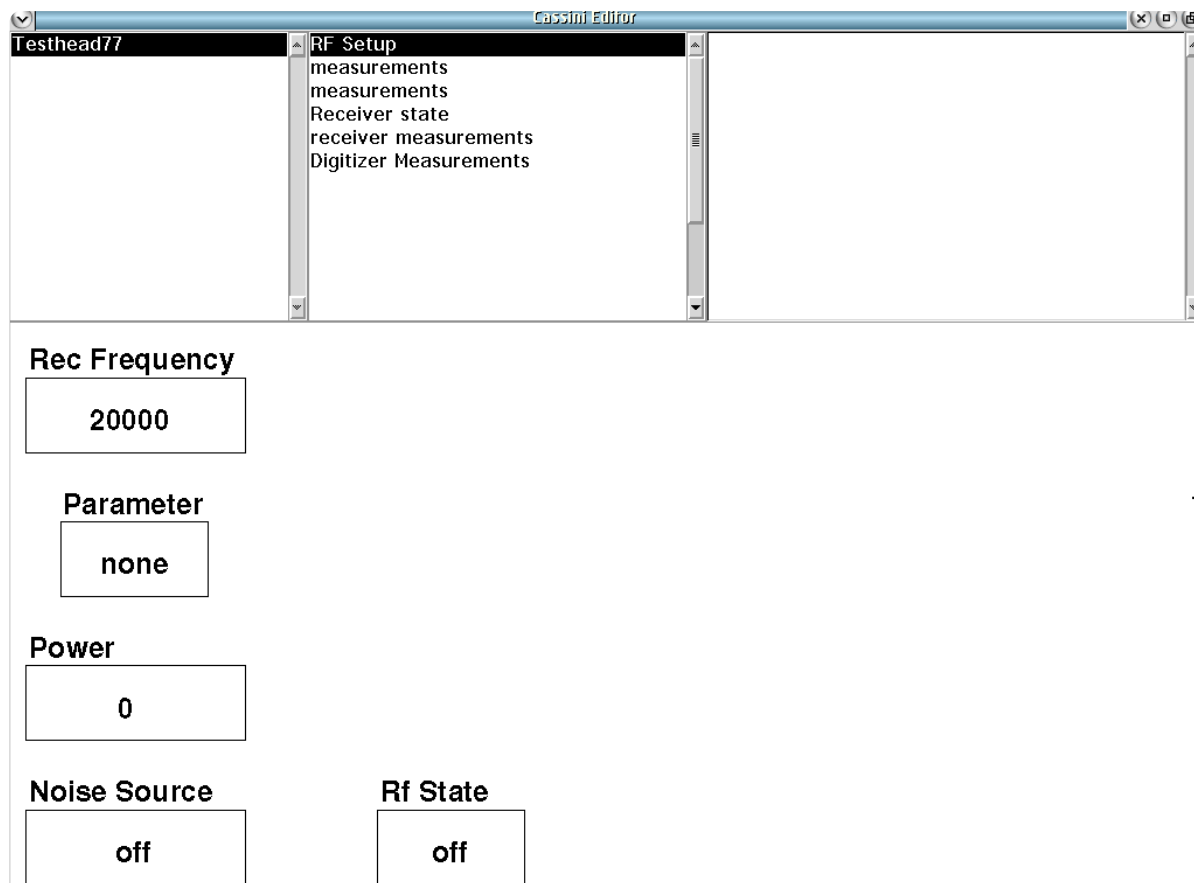
*NOTE: Multiple RI8580 instruments are enumerated incrementally by the system as “2”, “3”, etc. in the configuration, edit, and control panels (i.e - Test Head66, Test Head662, Test Head663, etc). The “x” in RI8580x denotes the model revision number.*

## EDIT PANELS

Automated control of the instruments in this TIM with use by the Test Plan Editor.

*Note: Screenshots show Test Head66 buttons, subject to change.*

### EDIT PANELS 18 RI8580: 57 TO 64GHZ TEST SET



Testhead66 RF Setup shows state configuration options.

## PANEL: RF SETUP

Parameter

none

### Parameter

Drop down list button that designates which of the coupler ports will be routed to the switching network. It is typically used for routing incident/reflected wave signals to the receiver for wave/s-parameter measurements.

Choices: a1, b1, b2, Rf4

The 'a1', 'b1'. and 'b2' selections uses the compiler's expert system to automatically select the correct switch routing. These selections require an RF port to be set by **Input Port** and **Output Port** buttons and corresponding **Rf 2/Rf 3**, **Rf 6** or **Rf 7** button selections.

*Note:*

*a1 is the incident wave to the input port of the device under test.*

*b1 is the reflected wave from the input port of the device under test.*

*b2 is the reflected wave from the output port of the device under test.*

**Noise Source**

Drop down list select button that sets Noise Source on or off

Noise Source

off

**Power**

Decimal notation input button that sets power at the device to a dBm value. Resolution is 0.1 dBm.

Power

0

**Rec Frequency**

Decimal notation input button that sets the receiver frequency in MHz.

Rec Frequency

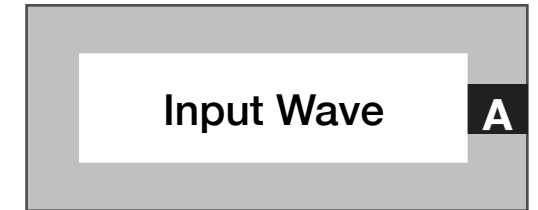
20000

**Rf State**

A drop down list button that sets the RF source output to the “on” or “off” state.

Rf State

off

**PANEL: MEASUREMENTS****MEAS****Meas: Input Wave**

Measurement block that performs power corrected one port wave parameters at the receive Frequency.

**MEAS****Meas: Corrected S11**

Measurement block that performs a corrected S11 parameter measurement.

Average Mode

std

**Average Mode**

A drop down list button that is associated with the higher-level macro measurement buttons that sets the method of averaging used.

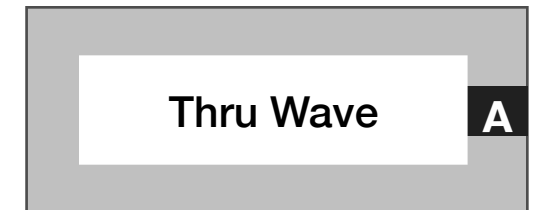
The “std” mode uses the number of Averages set by the System Button when measuring and completes all the averages of each of the parameters in a high-level macro button before moving to the next parameter. For example, on an S11 measurement with 4 averages, the tester would measure a<sub>1</sub>, a<sub>1</sub>, a<sub>1</sub>, a<sub>1</sub>, then b<sub>1</sub>, b<sub>1</sub>, b<sub>1</sub>, b<sub>1</sub>. This is the fastest averaging mode, but if the signal drifts while the a<sub>1</sub> measurements are being made, the measurement can be less accurate.

The “adjacent” mode uses the number of **Averages** set by the System Button as above, but when measuring to satisfy a high-level macro button, it takes data from each of the parameters needed one at a time, before completing another round of measurements for the average. For example, on an S<sub>11</sub> measurement with 4 averages, the tester would measure a<sub>1</sub>, b<sub>1</sub>, a<sub>1</sub>, b<sub>1</sub>, a<sub>1</sub>, b<sub>1</sub>, a<sub>1</sub>, b<sub>1</sub>. This makes the a<sub>1</sub> and b<sub>1</sub> measurements virtually simultaneous. The “adjacent averaging” mode is slightly slower than the “std” mode, but can minimize the effects of any signal drift especially for large number of averages.

*NOTE: At higher frequencies and with averages greater than 8 to 16, some improvement in accuracy and repeatability are often achieved using the adjacent averaging mode.*

## PANEL: MEASUREMENTS

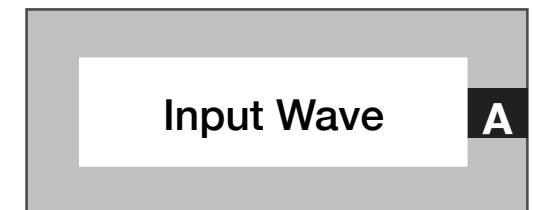
### MEAS



### Meas: Thru Wave

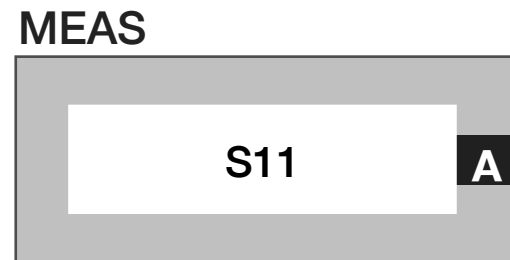
Measurement block that performs a<sub>11</sub> and b<sub>21</sub> measurement at the input frequency. The result is corrected to be absolute voltage. note that the phase is only defined within a test and not with any other readings.

### MEAS



### Meas: Input Wave

Measurement block that performs a power corrected wave measurement.



### Meas: Corrected S11

Measurement block that performs a corrected S11 parameter measurement.

### PANEL: RECEIVER STATE

If Bw

200 kHz

### If Bw

Drop down list select button that sets the receiver's analog detection bandwidth within the "IF Board, 21.4 MHz" in the block diagram. The '5 MHz' option is the full bandwidth of the receiver's front-end.

The '7 KHz' value is a bandpass filter applied before the IF signal is converted to zero IF/baseband.

The '200 kHz' is a low pass filter applied after IF conversion to zero IF.

The 'TOI' value activates a filtering/gain/attenuator mode that selects the '7 kHz' IF filter and optimizes the IF and baseband gain/attenuator scheme for third order intercept measurements. In 'TOI' mode the **If Gain** button is limited to values of '8' and '14'.

**If Gain**

20

**If Gain**

Drop down list select button that sets the gain of an amplifier in units of dB within the “IF Board, 21.4MHz” shown in the block diagram. This value should be optimized for best dynamic range. The selection options of ‘8’, ‘14’, ‘20’, ‘26’, ‘32’, ‘38’, ‘44’, ‘50’, ‘56’, ‘62’, and ‘68’ are in units of dB.

*NOTE: Optimal settings are achieved by increasing the value until an overflow messages appears in the message window during test compile or run and then selecting the value below the setting that causes an overflow warnings.*

**Samples**

1

**Samples**

A integer button that is the number of samples per waveform measure points.

**Meas Rate**

80000

**Meas Rate**

Decimal notation data button that sets the measure rate. The fastest is 200 KHz

**Rms Bw**

Slow

**Rms Bw**

Sets the post detection bandwidth. RMS uses a 10 MHz IF bandwidth always.

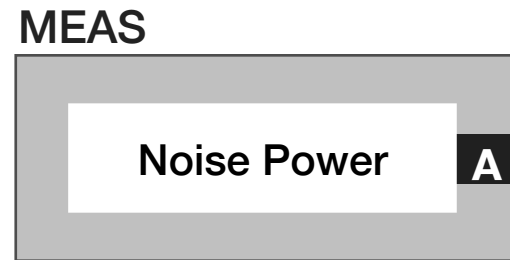
**Rms Gain**

High

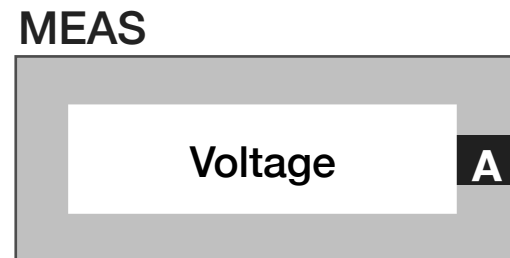
**Rms Gain**

Drop down list button that sets the post-detection gain. ‘Low’ is approximately -20dB.

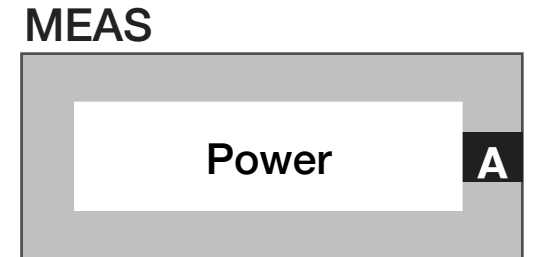


**PANEL: RECEIVER MEASUREMENTS****Meas: Noise Power**

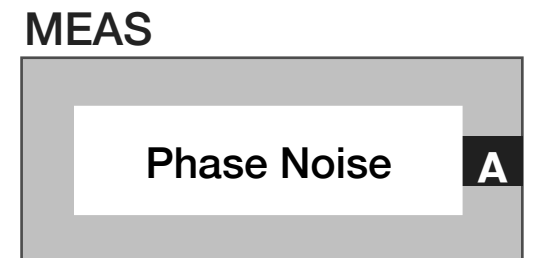
Measurement block that performs a noise power measurement for the current path.

**Meas: Voltage**

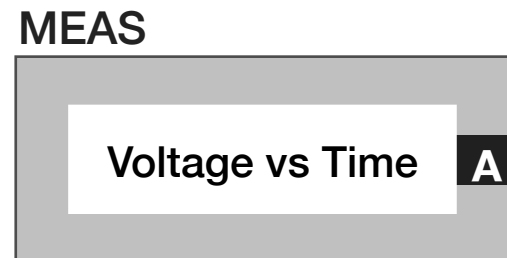
Measurement block that performs a complex voltage measurement for the current path.

**Meas: Power**

Measurement block that performs a corrected power measurement for the current path. Converts voltage to power and then averages the result

**Meas: Phase Noise**

Measurement block that performs the noise power measurement in a 1 Hz bandwidth using the current path. Uses the **Noise Power** measurement as its base.

**Meas: Voltage Vs Time**

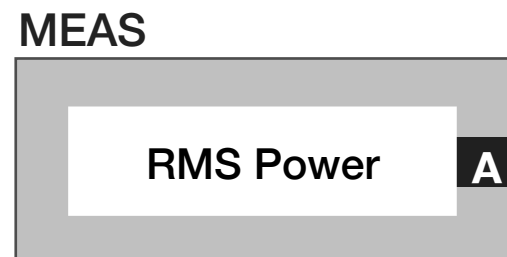
Measurement block that creates a vector of complex voltage measurements vs Time. The vector is a Complex data type.

**Meas: RMS Power Vs Time**

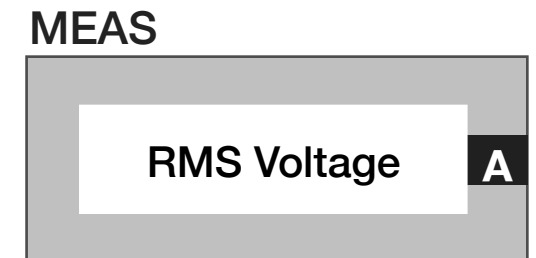
MEAS



Measurement block that creates a vector of RMS Power measurements vs. Time.

**Meas: RMS Power**

Measurement block that performs RMS power measurement for current path using the RMS/Noise detector.

**Meas: RMS Voltage**

Measurement block that performs a RMS voltage measurement using hardware RMS calculation.

*Note: Fully error corrected Scalar data type.*

## PANEL: DIGITIZER MEASUREMENTS

Trigger

off

### Trigger

Drop down list button that is used in a pre/post measure groups to activate ('on') or deactivate ('off') triggered receiver measurements. This button is commonly used with the **Delay** button in the pre/post measure group and the **Trigger Mode** button in the test panel or section default.

Trigger Mode

normal

### Trigger Mode

Drop down list button that configures the receiver's detector hardware for different trigger/pulse type measurements. This button is commonly used in test panels with the **Trigger** and **Delay** buttons placed in pre/post measure groups.

The 'normal' selection uses the receiver's voltage detector for triggered measurements.

The 'voltage' selection performs the same function as the 'normal' mode.

The 'power' selection uses the RMS detector for triggered measurements.

The 'V vs T' selection uses the voltage detector for triggered **Voltage vs Time** block measurements.

Delay

0

### Delay

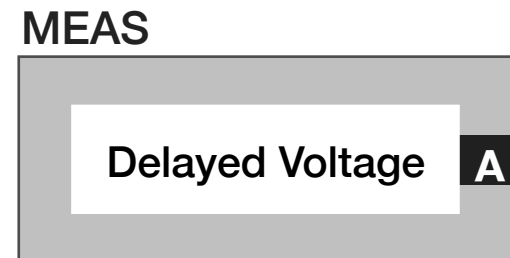
Decimal notation input button used within pre/post measure groups to delay the start of a triggered measurement with a user-defined duration. The value is in units of seconds with a maximum value of 0.01 seconds and a resolution of 1 $\mu$ s. This button is commonly used with the **Trigger** button.

MEAS

Delayed Power A

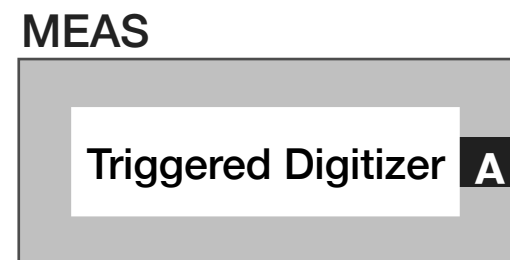
### Meas: Delayed Power

Measurement block that performs a RMS power measurement after a specified delay time set by the **Delay** button.



### Meas: Delayed Voltage

Measurement block that performs a complex voltage after a specified delay time set by the **Delay** button.



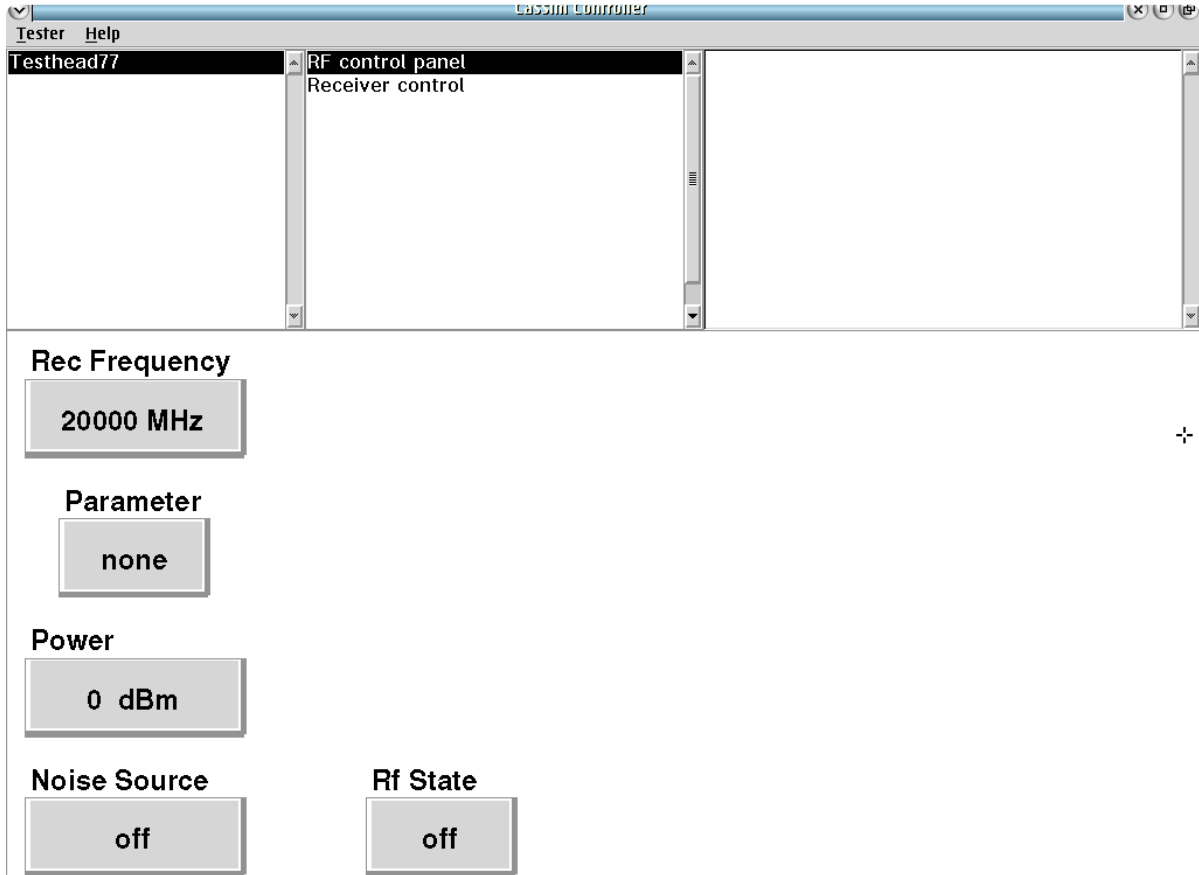
### Meas: Triggered Digitizer

Measurement block that performs a complex voltage measurement vs time relative to a trigger in the premeasure group set by **Trigger** and **Trigger Mode** buttons.

# CONTROL PANELS

Real time control of the instruments in this TIM.

## CONTROL PANELS 13 RI8564: 75 TO 81GHZ TEST SET



Testhead66 **RF Control panel** provides real-time state controls for this TIM.



## RECEIVER CONTROL

### POWER DBM, VOLTAGE DBM, NOISE DBM/HZ, RMSDBM

The above values are refreshed when LMB clicked within the button.

# RI8581: 100kHz TO 20GHz RECEIVER



## TOPICS

---

[Instruments Provided by this TIM](#)

[Instrument Diagram with Edit Buttons](#)

[Edit Panel Button Descriptions](#)

[Control Panel](#)

Tap the links above to quickly access content



## INSTRUMENTS PROVIDED BY THIS TIM

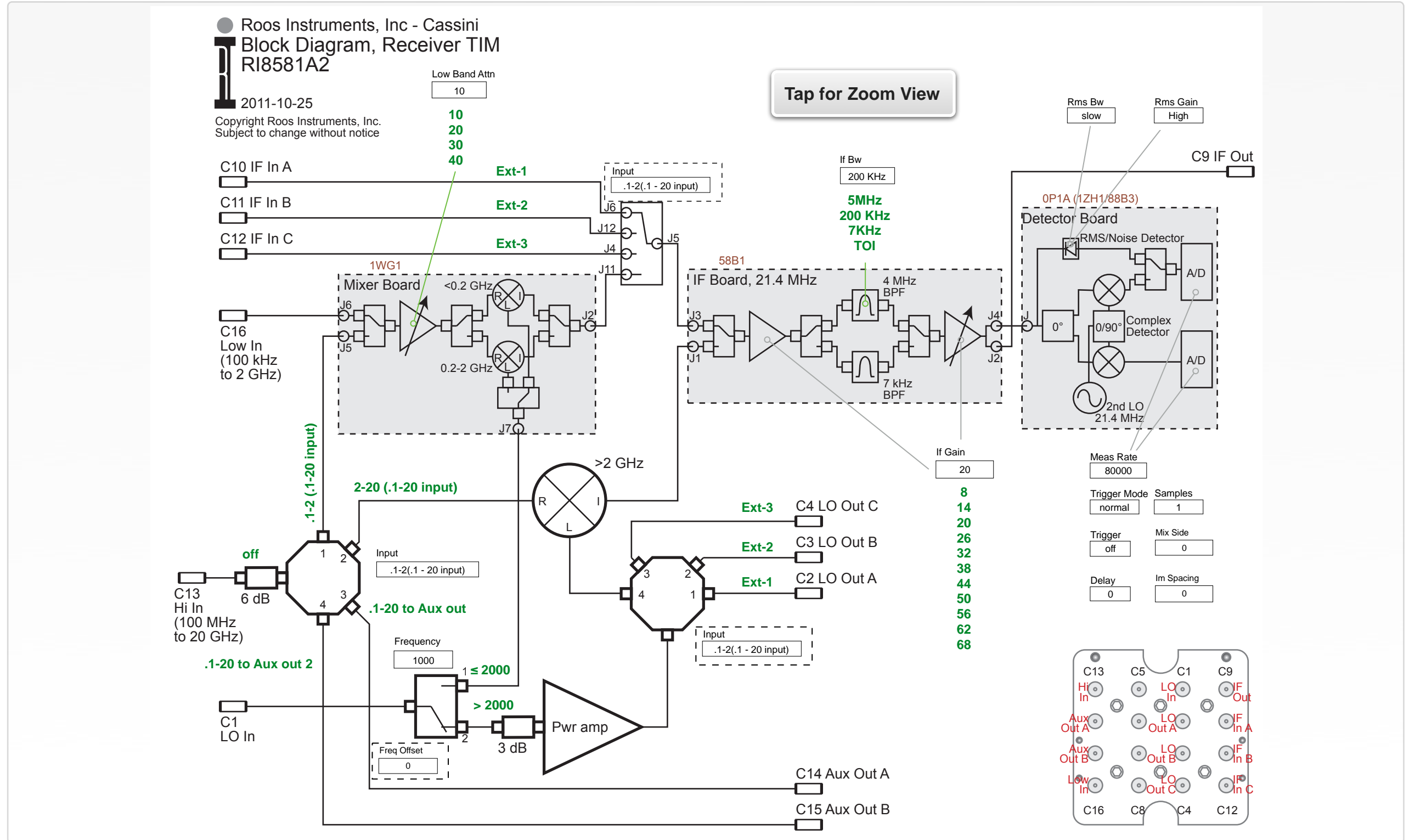
The instrument in this TIM appear as **Receiver** in the panel dialog windows.

Model and Name as it appears in the Tester Configuration:

- Receiver, RI8581x .01 to 20 GHz Complex Receiver TIM

*NOTE: Multiple RI8581 instruments are enumerated incrementally by the system as "2", "3", etc. in the configuration, edit, and control panels (i.e - Receiver, Receiver2, Receiver3, etc). The "x" in RI8581x denotes the model revision number.*

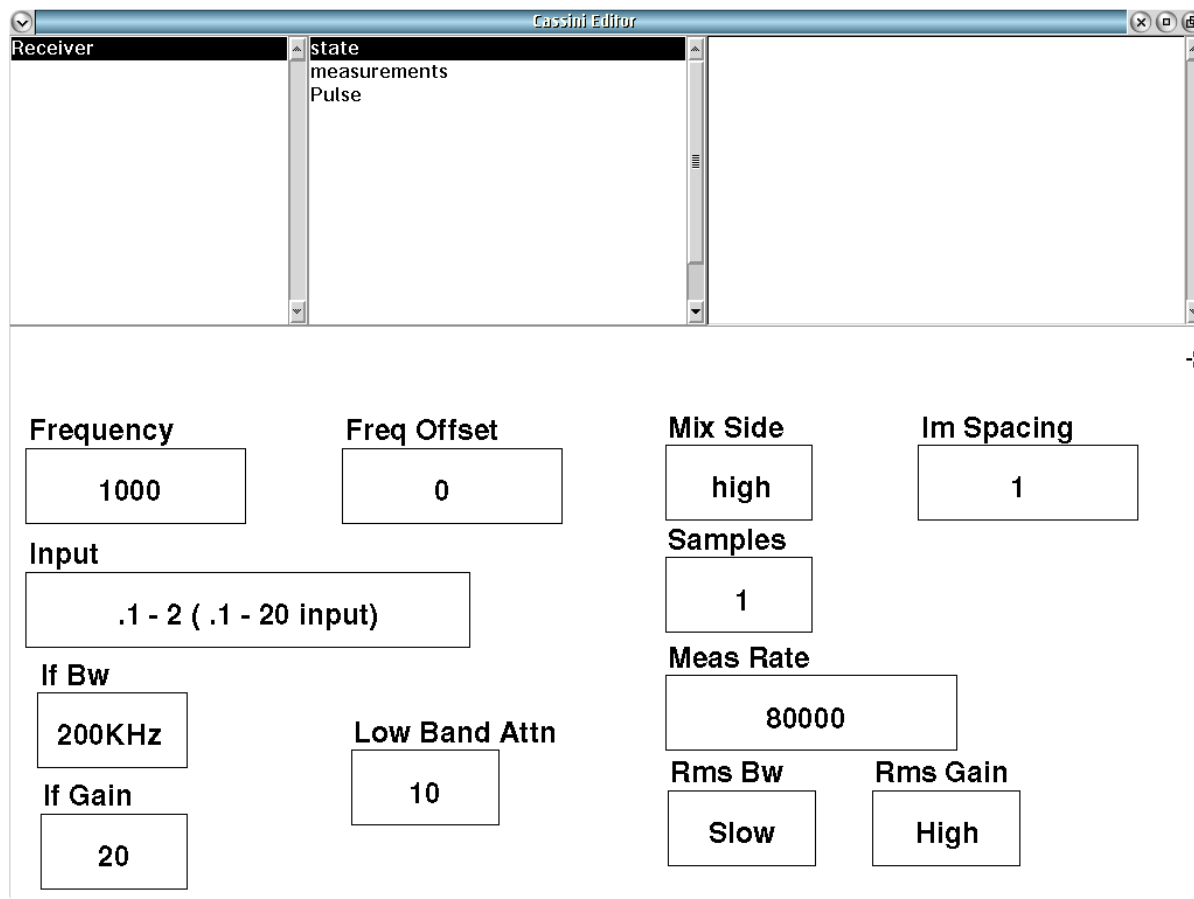
# INSTRUMENT BUTTON DIAGRAM 2.11



## EDIT PANELS

Automated control of the instruments in this TIM with use by the Test Plan Editor.

### EDIT PANELS 19 RI8581: 100MHZ TO 20GHZ RECEIVER



Receiver **state** buttons for control of the receiver.



### PANEL: STATE

Frequency

1000

### Frequency

Decimal notation input button that sets the tuned frequency of the receiver in MHz. This frequency value is set by the system reference button when using a virtual instrument such as: VNA, noise figure, or other multi-TIM measurement.

*NOTE: This button is only used for measurements defined by the receiver instrument such as a power or vector voltage measurement.*

Freq Offset

0

### Freq Offset

Decimal notation input button that sets the receiver output offset frequency in MHz. Typical offset range is  $\pm 5$  MHz.

*NOTE: A maximum offset range of  $\pm 10$  MHz is possible within certain frequency ranges. Consult the message window during compile to ensure offset compliance for a given center frequency.*

## Mix Side

Drop down list select button that selects the 'High' (upper) or 'Low' (lower) sideband of the down-converted signal image to be digitized by the receiver. 'Default' allows the compiler to select the optimal value.

*NOTE: Changing from the default setting can affect tester accuracy. The 'high' or 'low' button settings should only be used if there is spurious or undesirable spectral content from the device under test in the default sideband which interferes with the measurement. For best accuracy, the 'default' setting should be used.*

Mix Side

high

## Im Spacing

Set the spacing in MHz between the two signals used for an intermodulation measurement.

NOTE: The receiver frequency must be set to the frequency value that is center and equidistant between the two signals of interest.

Im Spacing

1

Input

.1-2 (.1 - 20 input)

## Input

Drop down list select button that routes the selected physical input port to the receiver's downconversion/digitizer path or to another port on the instrument test head.

'1-2 (.1-20 input)' and '2-20 (.1-20 input)' options connect input port *Hi In* located at C13 on the instrument test head to the downconverter/digitizer.

'1 - 20 to Aux out' routes the input port **Hi In** located at C13 on the instrument test head to the output port *Aux Out A* located at C14 on the instrument test head.

'1 - 20 to Aux out 2' routes the input port *Hi In* (C13) to the output port *Aux Out B* (C15) on the instrument test head.

'005 - 2 Input' connects the input port *Low In* (C16) to the downconverter/digitizer.

'off' disconnects all input ports from the receiver's downconverter/digitizer.

'Cal' is used for RI internal purposes only.

'LO Cal' connects *LO In* (C16) to the receiver's downconverter/digitizer.

'Ext-1' routes *IF In A* (C10) as an input to the receiver and routes *LO In* (C1) to *LO Out A* (C2) as an output.

'Ext-2' routes *IF In A* (C10) as an input to the receiver and routes *LO In* (C1) to *LO Out A* (C2) as an output.

'Ext-3' routes *IF In A* (C10) as an input to the receiver and routes *LO In* (C1) to *LO Out A* (C2) as an output.

*NOTE: The 'Ext-1', 'Ext-2', and 'Ext-3' options are used to support the IF and LO port routing requirements for frequency converting testsets (RI8560: 56GHz to 67GHz TestSet, RI8563: 4GHz to 40.5GHz TestSet, RI8564: 71GHz to 83GHz TestSet) or external mixer/frequency converters in the fixture.*

## Samples

Decimal notation input button that sets the total number of measurement samples.

Samples

1

## If Bw

Drop down list select button that sets the receiver's analog detection bandwidth within the "IF Board, 21.4 MHz" in the block diagram. The '5 MHz' option is the full bandwidth of the receiver's front-end.

If Bw

200 KHz

The '7 KHz' value is a bandpass filter applied before the IF signal is converted to zero IF/baseband.

The '200 kHz' is a low pass filter applied after IF conversion to zero IF.

The 'TOI' value activates a filtering/gain/attenuator mode that selects the '7 kHz' IF filter and optimizes the ratio of the gain scheme for the amplifiers on the input and output sides of the IF filter to place all of the gain on the output side for high-fidelity third order intercept measurements. In 'TOI' mode the **If Gain** button is limited to values of '8' and '14'.

*NOTE: The If BW button value is ignored and a 10 MHz IF bandwidth is used when a RMS Power, RMS Power vs. Time, or RMS Voltage measurement block is used in a test panel.*

## Low Band Attn

Drop down list select button that sets the baseband gain attenuator found at the output of the "Mixer Board" in the block diagram to optimize the receiver analog path for best dynamic range. The options '10', '20', '30', and '40' represent attenuation values in units of dB.

Low Band Attn

10

## If Gain

Drop down list select button that sets the gain of an amplifier in units of dB within the “IF Board, 21.4MHz” shown in the block diagram. This value should be optimized for best dynamic range. The selection options of ‘8’, ‘14’, ‘20’, ‘26’, ‘32’, ‘38’, ‘44’, ‘50’, ‘56’, ‘62’, and ‘68’ are in units of dB.

*NOTE: Optimal settings are achieved by increasing the value until an overflow messages appears in the message window during test compile or run and then selecting the value below the setting that causes an overflow warnings.*

*When used with the If Bw button set to the ‘TOI’ option, the If Gain setting is a ratio between the input and output amplifiers of the IF filters to place all of the gain on the output side. In this mode, only the ‘8’ and ‘14’ values of the IF gain button are valid.*

If Gain

20

## Meas Rate

Decimal notation input button that sets the sample rate of the receiver’s digitizer in units of Hz. The maximum sample rate is 200 kHz.

Meas Rate

80000

## Rms Bw

Drop down list select button that sets the post-detection bandwidth for Root Mean Squared (RMS) measurements. This button is used to optimize the settling speed of the detectors lock and measure speed. It is used with the **RMS Power**, **RMS Voltage**, and **RMS PowerVsTime** measurement blocks.

*NOTE: The ‘Fast’ setting can be susceptible to increased measurement instability due to DUT and fixture path dependent settling times.*

An RMS measurement overrides the **If Bw** button and uses a 10 MHz IF bandwidth setting.

*NOTE: The RMS detector receive path is automatically selected when an RMS Power, RMS Voltage, or RMS PowerVsTime measurement block is used.*

Rms Bw

slow



Rms Gain

High

## Rms Gain

Drop down list button that sets the post-detection gain. This button is commonly used with the **RMS Power**, **RMS Voltage**, and **RMS PowerVsTime** measurement blocks.

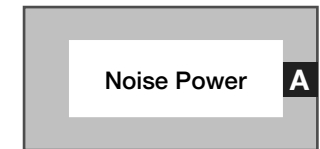
The 'High' setting is approximately 0dB.

The 'Low' setting is approximately -20dB.

*NOTE: The RMS detector receive path is automatically selected when an RMS Power, RMS Voltage, or RMS PowerVsTime measurement block is used.*

## PANEL: MEASUREMENTS

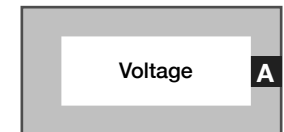
MEAS



### Meas: Noise Power

Measures noise power for a selected port using the dedicated noise detector in the receiver's baseband subsystem.

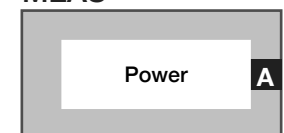
MEAS



### Meas: Voltage

Measures an RF signals complex voltage amplitude for the selected port. The input signal is mixed with the receiver's orthogonal tuning signals, providing input signal phase and amplitude represented as a complex voltage value or voltage vector.

MEAS

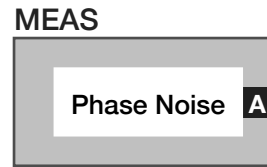


### Meas: Power

Measures the corrected signal power for the selected port and path. The block converts complex voltage to a scalar power value and then averages the result.

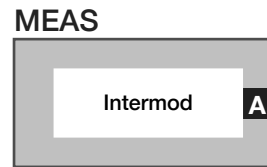
### Meas: Phase Noise

Measure the noise power in units of Watts/Hz in a 1 Hz bandwidth using the current setup. Uses the Noise Power measurement as its base.



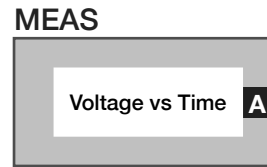
### Meas: Intermod

Use this button to measure the intermod intercept point of an amplifier in watts. The intermod signals are assumed to be above and below the center frequency and both sidebands are used to compute the intercept



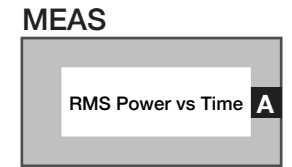
### Meas: VoltageVsTime

Measures an RF signal complex voltage amplitude or voltage vector and records the value with its corresponding measurement time.



### Meas: Rms Power Vs Time

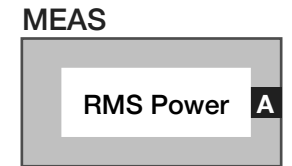
Measures RMS power for the selected port using the dedicated RMS/Noise detector path and records the corresponding measurement time.



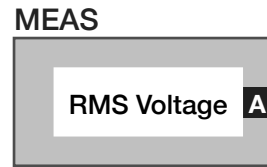
*NOTE: The If BW button value is ignored and a 10 MHz IF bandwidth is used when this measurement block is used in a test panel.*

### Meas: RMS Power

Measure the RMS power for the selected port using the RMS/Noise detector.



*NOTE: The If BW button value is ignored and a 10 MHz IF bandwidth is used when this measurement block is used in a test panel.*



### Meas: RMS Voltage

Measurement block measures RMS voltage by converting the complex voltage vector into a scalar amplitude vector and then computes the root mean square value.

*NOTE: The If BW button value is ignored and a 10 MHz IF bandwidth is used when this measurement block is used in a test panel.*

### PANEL: PULSE

Trigger

off

### Trigger

Drop down list button that activates ('on') or deactivates ('off') the trigger option on receiver measurements. Trigger on starts a measurement series

Trigger Mode

normal

### Trigger Mode

Drop down list button sets the trigger mode for the receiver's pulse/trigger measurement functions. Option 'normal' triggers normally, 'voltage' triggers on voltage value, 'power' triggers on power value, 'V vs T' triggers on Voltage vs Time value.

Delay

0

### Delay

Decimal notation input button that sets the delay between measurements in units of seconds for the pulse mode measurements. Resolution is 1µs.

## Meas: TriggeredDigitizer

Measures an RF signals complex voltage/voltage vector vs. time relative to a specified trigger in the premeasure.



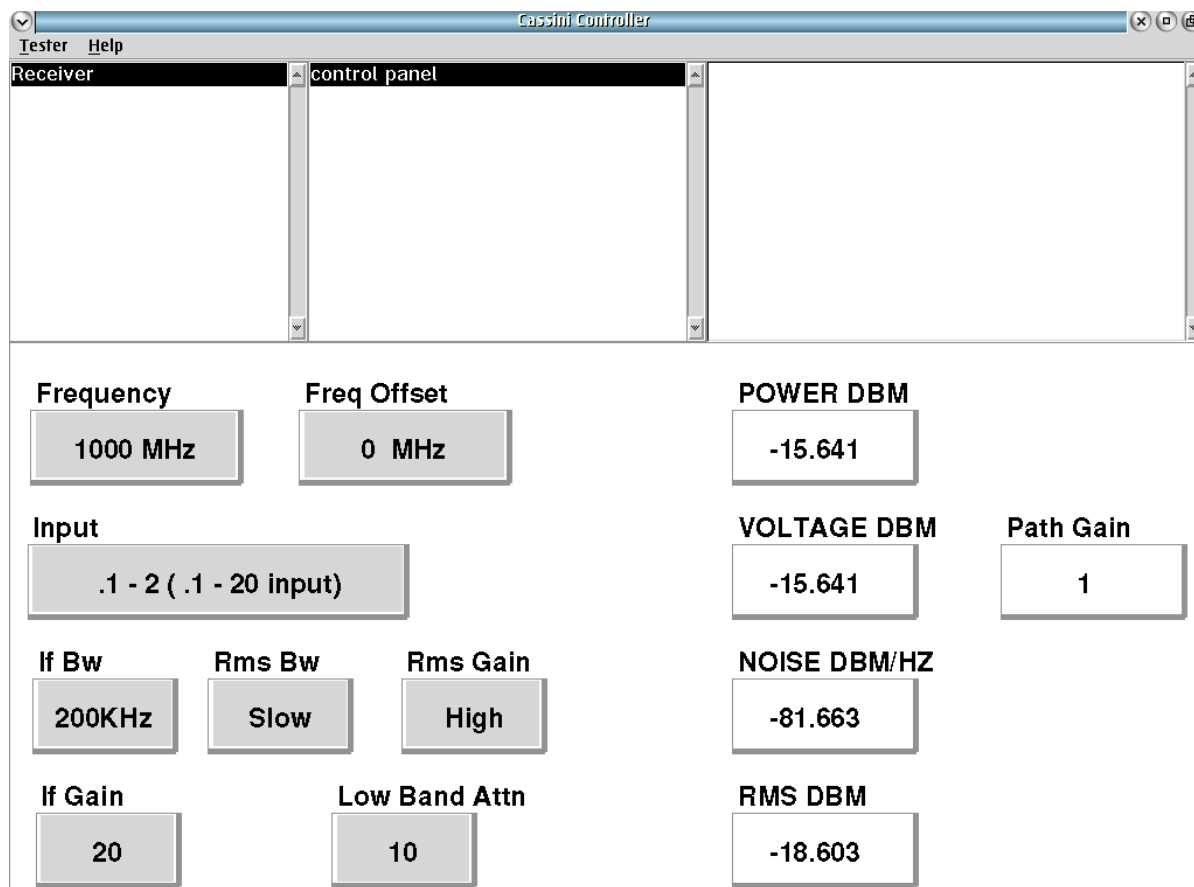
---

## CONTROL PANELS

Real time control of the instruments in this TIM.

## RECEIVER CONTROL

### CONTROL PANELS 14 RI8581: 100MHZ TO 20GHZ RECEIVER



Receiver **control panel** provides Power, Voltage, Noise and path gain as well as receiver state.

## POWER DBM, VOLTAGE DBM, NOISE DBM/HZ, RMS DBM, Path Gain

The above values are live, refreshed when clicked.

# RI8587: 100kHz TO 20GHz DSP RECEIVER



## TOPICS

---

[Instruments Provided by this TIM](#)

[Instrument Diagram with Edit Buttons](#)

[Edit Panel Button Descriptions](#)

[Control Panel](#)

Tap the links above to quickly access content



## INSTRUMENTS PROVIDED BY THIS TIM

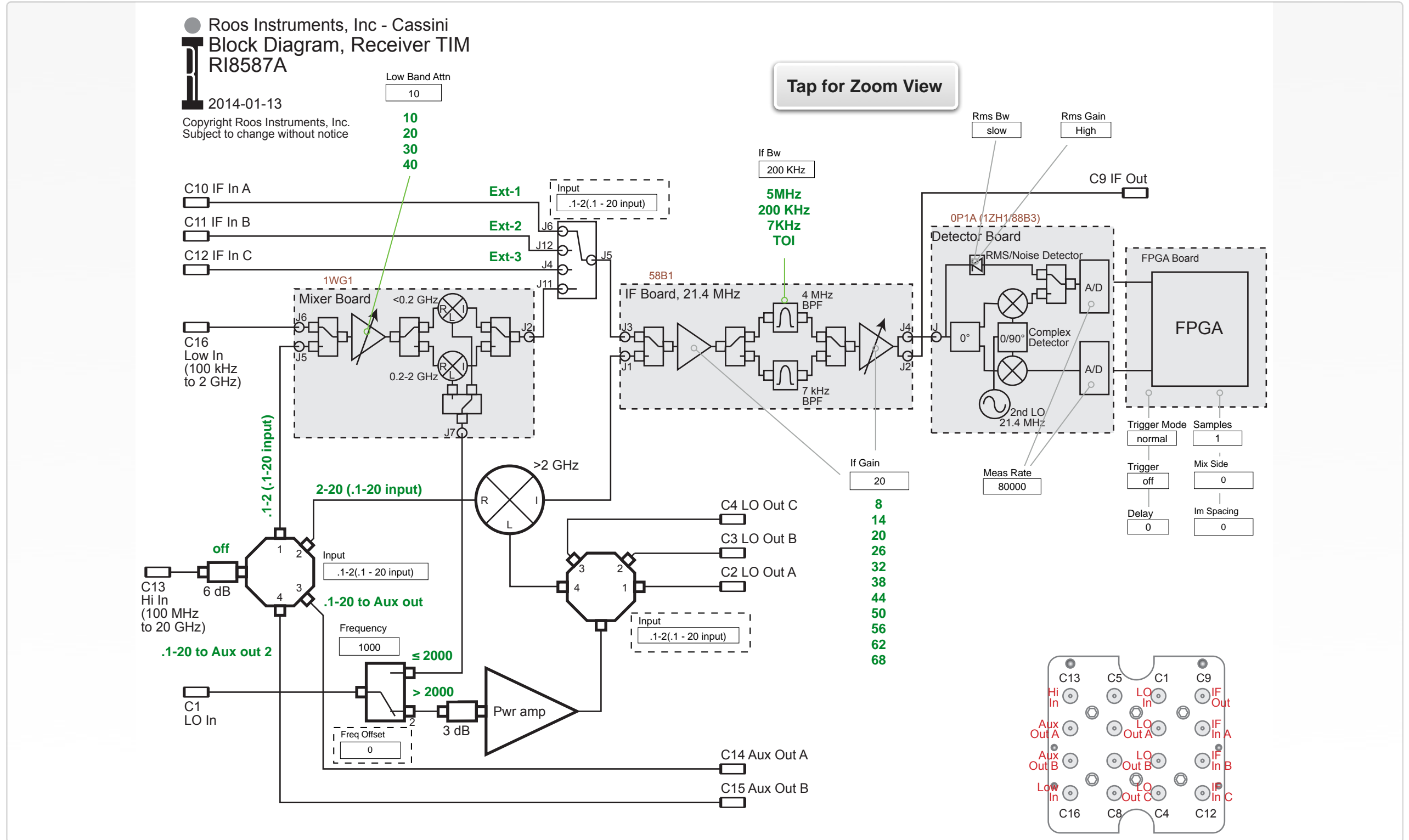
The instrument in this TIM appear as **Receiver** in the panel dialog windows.

Model and Name as it appears in the Tester Configuration:

- Receiver, RI8587x .01 to 20GHz Complex Receiver TIM w DSP

*NOTE: Multiple RI8587 instruments are enumerated incrementally by the system as “2”, “3”, etc. in the configuration, edit, and control panels (i.e - Receiver, Receiver2, Receiver3, etc). The “x” in RI8587x denotes the model revision number.*

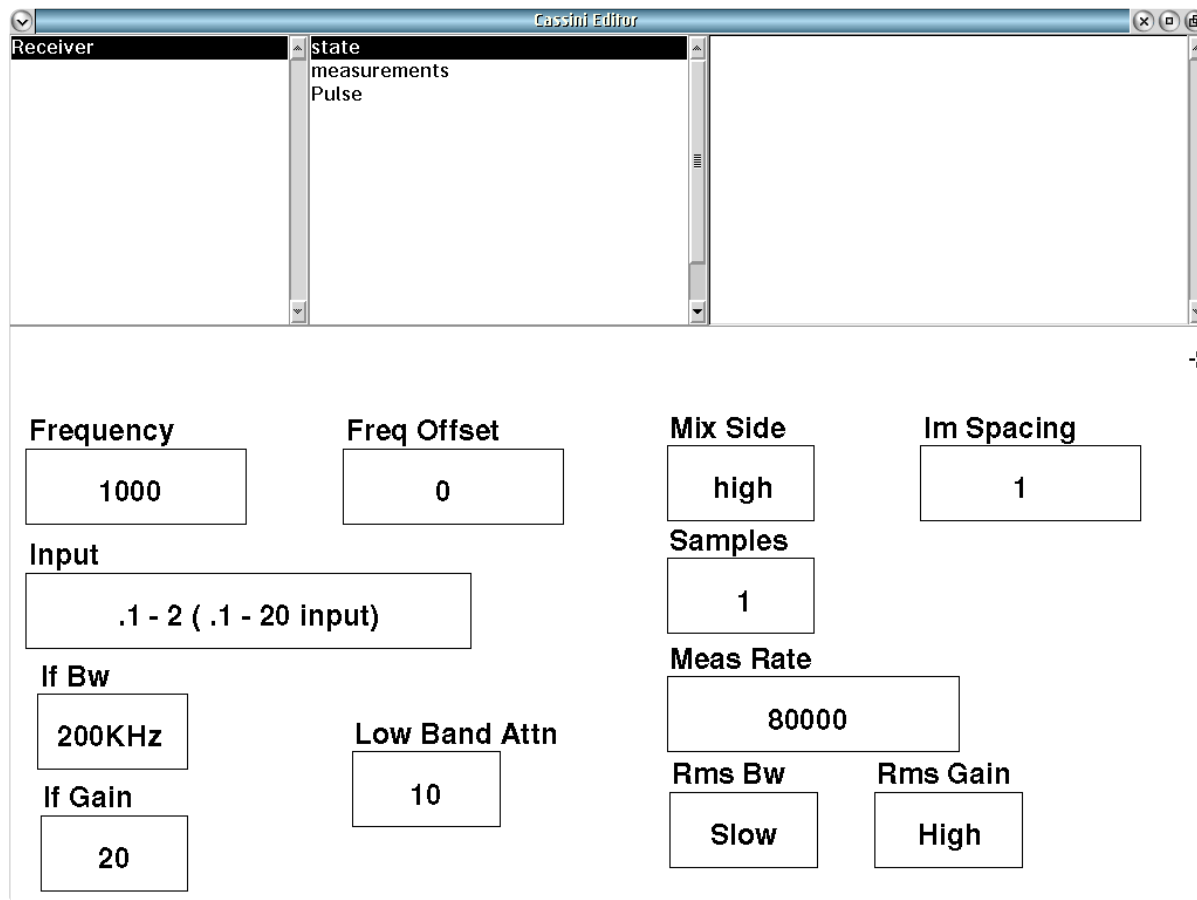
INSTRUMENT BUTTON DIAGRAM 2.12



## EDIT PANELS

Automated control of the instruments in this TIM with use by the Test Plan Editor.

### EDIT PANELS 20 RI8587: 100MHZ TO 20GHZ RECEIVER



Receiver **state** panel shows state options for the receiver.



### PANEL: STATE

Frequency

1000

### Frequency

Decimal notation input button that sets the tuned frequency of the receiver in MHz. This frequency value is set by the system reference button when using a virtual instrument such as: VNA, noise figure, or other multi-TIM measurement.

*NOTE: This button is only used for measurements defined by the receiver instrument such as a power or vector voltage measurement.*

Freq Offset

0

### Freq Offset

Decimal notation input button that sets the receiver output offset frequency in MHz. Typical offset range is  $\pm 5$  MHz.

*NOTE: A maximum offset range of  $\pm 10$  MHz is possible within certain frequency ranges. Consult the message window during compile to ensure offset compliance for a given center frequency.*

## Mix Side

Drop down list select button that selects the 'High' (upper) or 'Low' (lower) sideband of the down-converted signal image to be digitized by the receiver. 'Default' allows the compiler to select the optimal value.

*NOTE: Changing from the default setting can affect tester accuracy. The 'high' or 'low' button settings should only be used if there is spurious or undesirable spectral content from the device under test in the default sideband which interferes with the measurement. For best accuracy, the 'default' setting should be used.*

Mix Side

high

## Im Spacing

Set the spacing in MHz between the two signals used for an intermodulation measurement.

NOTE: The receiver frequency must be set to the frequency value that is center and equidistant between the two signals of interest.

Im Spacing

1

Input

.1-2 (.1 - 20 input)

## Input

Drop down list select button that routes the selected physical input port to the receiver's downconversion/digitizer path or to another port on the instrument test head.

'1-2 (.1-20 input)' and '2-20 (.1-20 input)' options connect input port *Hi In* located at C13 on the instrument test head to the downconverter/digitizer.

'1 - 20 to Aux out' routes the input port **Hi In** located at C13 on the instrument test head to the output port *Aux Out A* located at C14 on the instrument test head.

'1 - 20 to Aux out 2' routes the input port *Hi In* (C13) to the output port *Aux Out B* (C15) on the instrument test head.

'005 - 2 Input' connects the input port *Low In* (C16) to the downconverter/digitizer.

'off' disconnects all input ports from the receiver's downconverter/digitizer.

'Cal' is used for RI internal purposes only.

'LO Cal' connects *LO In* (C16) to the receiver's downconverter/digitizer.

'Ext-1' routes *IF In A* (C10) as an input to the receiver and routes *LO In* (C1) to *LO Out A* (C2) as an output.

'Ext-2' routes *IF In A* (C10) as an input to the receiver and routes *LO In* (C1) to *LO Out A* (C2) as an output.

'Ext-3' routes *IF In A* (C10) as an input to the receiver and routes *LO In* (C1) to *LO Out A* (C2) as an output.

*NOTE: The 'Ext-1', 'Ext-2', and 'Ext-3' options are used to support the IF and LO port routing requirements for frequency converting testsets (RI8560: 56GHz to 67GHz TestSet, RI8563: 4GHz to 40.5GHz TestSet, RI8564: 71GHz to 83GHz TestSet) or external mixer/frequency converters in the fixture.*

## Samples

Decimal notation input button that sets the total number of measurement samples.

Samples

1

## If Bw

Drop down list select button that sets the receiver's analog detection bandwidth within the "IF Board, 21.4 MHz" in the block diagram. The '5 MHz' option is the full bandwidth of the receiver's front-end.

If Bw

200 KHz

The '7 KHz' value is a bandpass filter applied before the IF signal is converted to zero IF/baseband.

The '200 kHz' is a low pass filter applied after IF conversion to zero IF.

The 'TOI' value activates a filtering/gain/attenuator mode that selects the '7 kHz' IF filter and optimizes the ratio of the gain scheme for the amplifiers on the input and output sides of the IF filter to place all of the gain on the output side for high-fidelity third order intercept measurements. In 'TOI' mode the **If Gain** button is limited to values of '8' and '14'.

*NOTE: The If BW button value is ignored and a 10 MHz IF bandwidth is used when a RMS Power, RMS Power vs. Time, or RMS Voltage measurement block is used in a test panel.*

## Low Band Attn

Drop down list select button that sets the baseband gain attenuator found at the output of the "Mixer Board" in the block diagram to optimize the receiver analog path for best dynamic range. The options '10', '20', '30', and '40' represent attenuation values in units of dB.

Low Band Attn

10

If Gain

20

## If Gain

Drop down list select button that sets the gain of an amplifier in units of dB within the “IF Board, 21.4 MHz” shown in the block diagram. This value should be optimized for best dynamic range. The selection options of ‘8’, ‘14’, ‘20’, ‘26’, ‘32’, ‘38’, ‘44’, ‘50’, ‘56’, ‘62’, and ‘68’ are in units of dB.

*NOTE: Optimal settings are achieved by increasing the value until an overflow messages appears in the message window during test compile or run and then selecting the value below the setting that causes an overflow warnings.*

*When used with the If Bw button set to the ‘TOI’ option, the If Gain setting is the ratio between the input and output amplifiers of the IF filters to place all of the gain on the output side. In this mode, only the ‘8’ and ‘14’ values of the IF gain button are valid.*

Meas Rate

80000

## Meas Rate

Decimal notation input button that sets the sample rate of the receiver’s digitizer in units of Hz. The maximum sample rate is 200 kHz.

Rms Bw

slow

## Rms Bw

Drop down list select button that sets the post-detection bandwidth for Root Mean Squared (RMS) measurements. This button is used to optimize the settling speed of the detectors lock and measure speed. It is commonly used with the **RMS Power**, **RMS Voltage**, and **RMS PowerVsTime** measurement blocks.

*NOTE: The ‘Fast’ setting can be susceptible to increased measurement instability due to DUT and fixture path dependent settling times.*

An RMS measurement overrides the **If Bw** button and uses a 10 MHz IF bandwidth.

*NOTE: The RMS detector receive path is automatically selected when an RMS Power, RMS Voltage, or RMS PowerVsTime measurement block is used.*



Rms Gain

High

## Rms Gain

Drop down list button that sets the post-detection gain. This button is commonly used with the **RMS Power**, **RMS Voltage**, and **RMS PowerVsTime** measurement blocks.

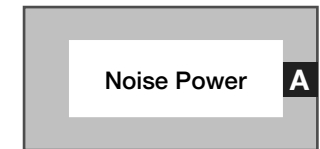
The 'High' setting is approximately 0dB.

The 'Low' setting is approximately -20dB.

*NOTE: The RMS detector receive path is automatically selected when an RMS Power, RMS Voltage, or RMS PowerVsTime measurement block is used.*

## PANEL: MEASUREMENTS

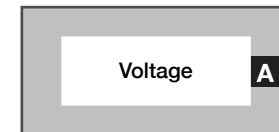
MEAS



### Meas: Noise Power

Measurement block measures noise power for a selected port using the dedicated noise detector in the receiver's baseband subsystem.

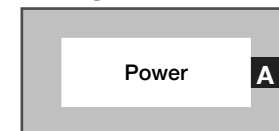
MEAS



### Meas: Voltage

Measures an RF signals complex voltage amplitude for the selected port. The input signal is mixed with the receiver's orthogonal tuning signals, providing input signal phase and amplitude represented as a complex voltage value or voltage vector.

MEAS

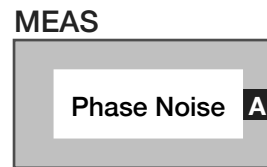


### Meas: Power

Measures the corrected signal power for the selected port and path. The block converts complex voltage to a scalar power value and then averages the result.

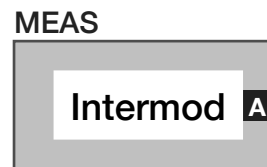
## Meas: Phase Noise

Measure the noise power in units of Watts/Hz in a 1Hz bandwidth using the current setup. Uses the **Noise Power** measurement block as the base measurement.



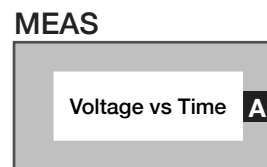
## Meas: Intermod

Use this button to measure the intermod intercept point of an amplifier in watts. The intermod signals are assumed to be above and below the center frequency and both sidebands are used to compute the intercept



## Meas: Voltage Vs Time

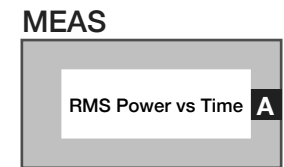
Measures an RF signal complex voltage amplitude/voltage vector and records the value with it's corresponding measurement time.



## Meas: RMS Power Vs Time

Measures RMS power for the selected port using the dedicated RMS/Noise detector path and records the corresponding measurement time.

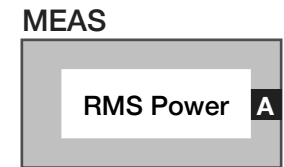
*NOTE: The If BW button value is ignored and a 10 MHz IF bandwidth is used when this measurement block is used in a test panel.*



## Meas: RMS Power

Measure the RMS power for the selected port using the RMS/Noise detector.

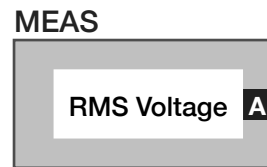
*NOTE: The If BW button value is ignored and a 10 MHz IF bandwidth is used when this measurement block is used in a test panel.*



## Meas: RMS Voltage

Measurement block measures RMS voltage by converting the complex voltage vector into a scalar amplitude vector and then computes the root mean square value.

*NOTE: The If BW button value is ignored and a 10 MHz IF bandwidth is used when this measurement block is used in a test panel.*



## PANEL: PULSE

### Trigger

Drop down list button that is used in a pre/post measure groups to activate ('on') or deactivate ('off') triggered receiver measurements. This button is commonly used with the **Delay** button in the pre/post measure group and the **Trigger Mode** button in the test panel or section default.

Trigger

off

Trigger Mode

normal

### Trigger Mode

Drop down list button that configures the receiver's detector hardware for different trigger/pulse type measurements. This button is commonly used in test panels with the **Trigger** and **Delay** buttons placed in pre/post measure groups.

The 'normal' selection uses the receiver's voltage detector for triggered measurements.

The 'voltage' selection performs the same function as the 'normal' mode.

The 'power' selection uses the RMS detector for triggered measurements.

The 'V vs T' selection uses the voltage detector for triggered **Voltage vs Time** block measurements.

Delay  
0

### Delay

Decimal notation input button used within pre/post measure groups to delay the start of a triggered measurement with a user-defined duration. The value is in units of seconds with a maximum value of 0.01 seconds and a resolution of 1 $\mu$ s. This button is commonly used with the **Trigger** button.

MEAS  
Triggered Digitizer A

### Meas: TriggeredDigitizer

Measurement block measures an RF signals complex voltage vector vs. time relative to a specified trigger in the premeasure. This measurement block is commonly used with the **Trigger**, **Trigger Mode**, and/or **Delay** buttons.

## PANEL: SPECTRUM MEASUREMENTS

If Shift

0

### If Shift

Decimal notation input button that sets the frequency offset for the FPGA-based mixer within the digital signal processor subsystem. Values are in units of Hz with a range of 0 to 100 kHz.

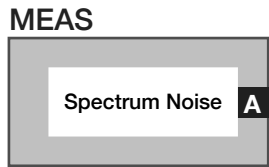
Det Bw

bypass

### Det Bw

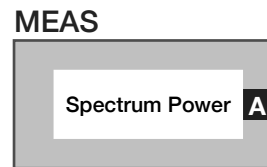
Drop down list button that configures the bandwidth of a post-measure, low-pass digital filter in the receive detector's FPGA-based DSP chain. These provide selectable, narrow-band filters with typically 60dB of stop band attenuation. The 'bypass' selection is the default, applying no digital filter. The other options are 200 kHz, 100 kHz, 50 kHz, 25 kHz, 10 kHz, 5 kHz, 2.5 kHz, and 1 kHz bandwidth filters.

## Meas: Spectrum Noise



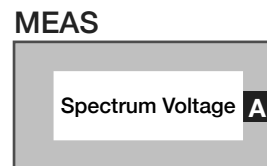
Measurement block computes noise using the receiver's FPGA-based, real-time DSP.

## Meas: Spectrum Power



Measurement block computes power vectors (complex power) using the receiver's FPGA-based, real-time DSP.

## Meas: Spectrum Voltage

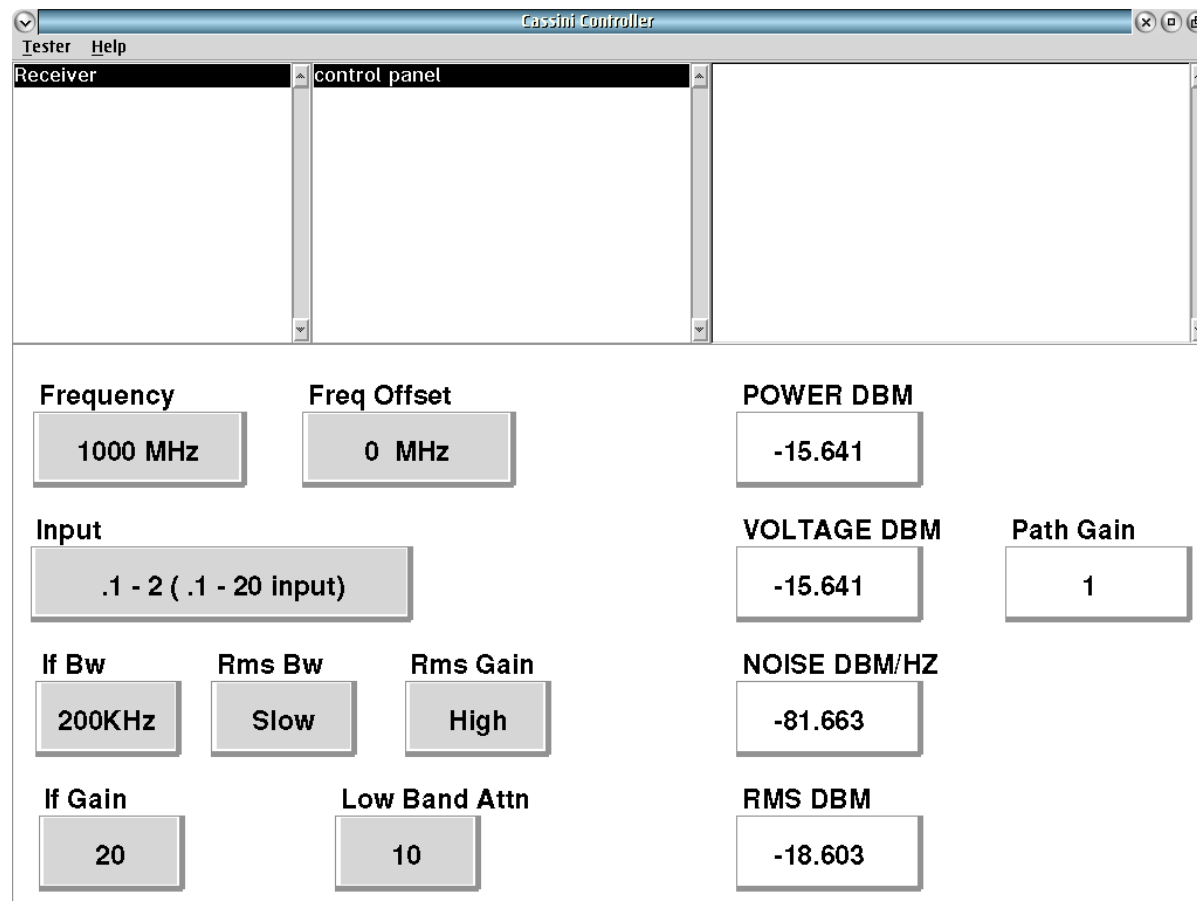


Measurement block computes spectral voltage vectors (complex voltage) versus time using the receiver's receiver's FPGA-based, real-time DSP.

## CONTROL PANELS

Real time control of the instruments in this TIM.

### CONTROL PANELS 15 RI8587: 100MHZ TO 20GHZ RECEIVER



The screenshot shows a window titled "Cassini Controller" with a menu bar containing "Tester" and "Help". Below the menu bar is a tabbed interface with a tab labeled "Receiver" and a sub-tab labeled "control panel". The main area of the window displays a grid of control panels for a receiver. The parameters shown are:

Frequency	Freq Offset	POWER DBM	VOLTAGE DBM	Path Gain	NOISE DBM/HZ	RMS DBM
1000 MHz	0 MHz	-15.641	-15.641	1	-81.663	-18.603

Additional parameters shown in the interface include:

- Input: .1 - 2 ( .1 - 20 input)
- If Bw: 200KHz
- Rms Bw: Slow
- Rms Gain: High
- If Gain: 20
- Low Band Attn: 10

Receiver **control panel** shows real-time states and Power, Voltage, Noise measurements made by the receiver.

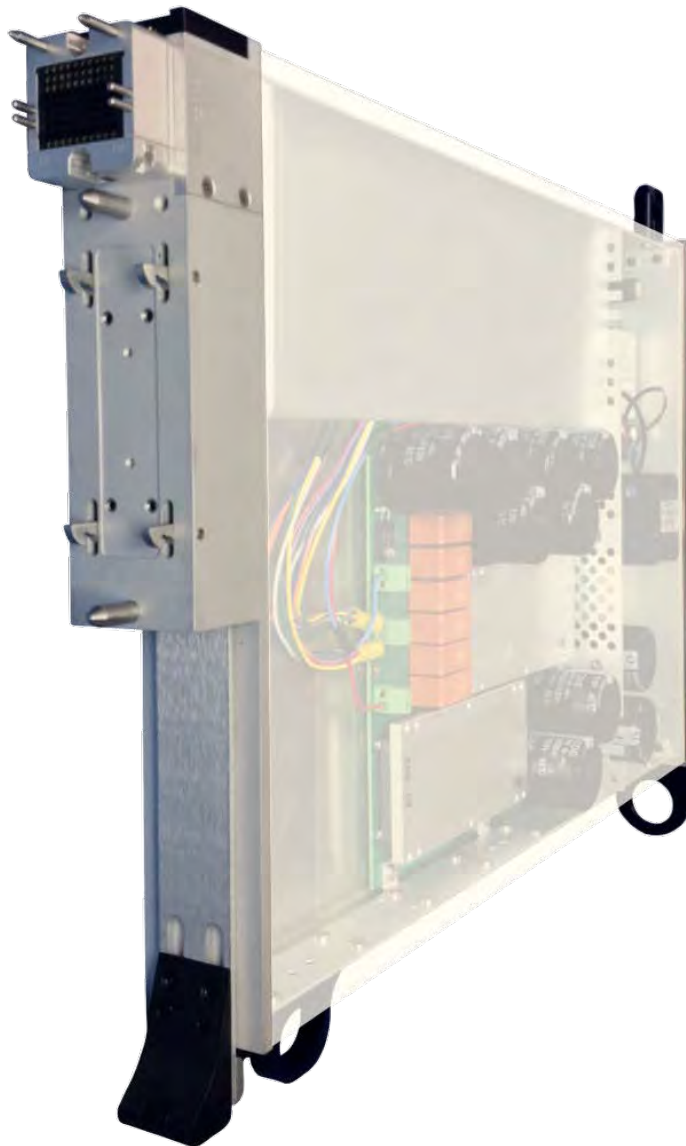
## CONTROL PANEL

### POWER DBM, VOLTAGE DBM, NOISE DBM/HZ, RMS DBM, Path Gain

Click to update these measurements in real-time.



# RI8589: HIGH POWER SUPPLY/PULSER



## TOPICS

---

[Instruments Provided by this TIM](#)

[Instrument Diagram](#)

[Edit Panel Button Descriptions](#)

[Control Panel](#)

[Example Test Panels](#)

Tap the links above to quickly access content

## INSTRUMENTS PROVIDED BY THIS TIM

The instrument in this TIM appear as **FetPulser** in the panel dialog windows.

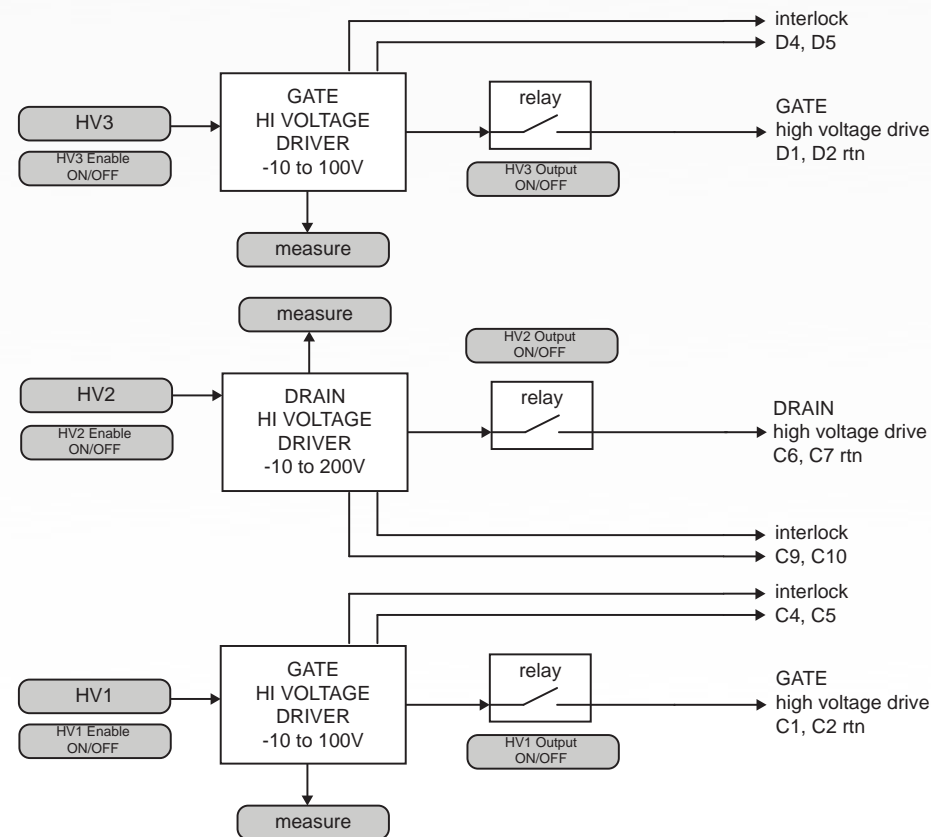
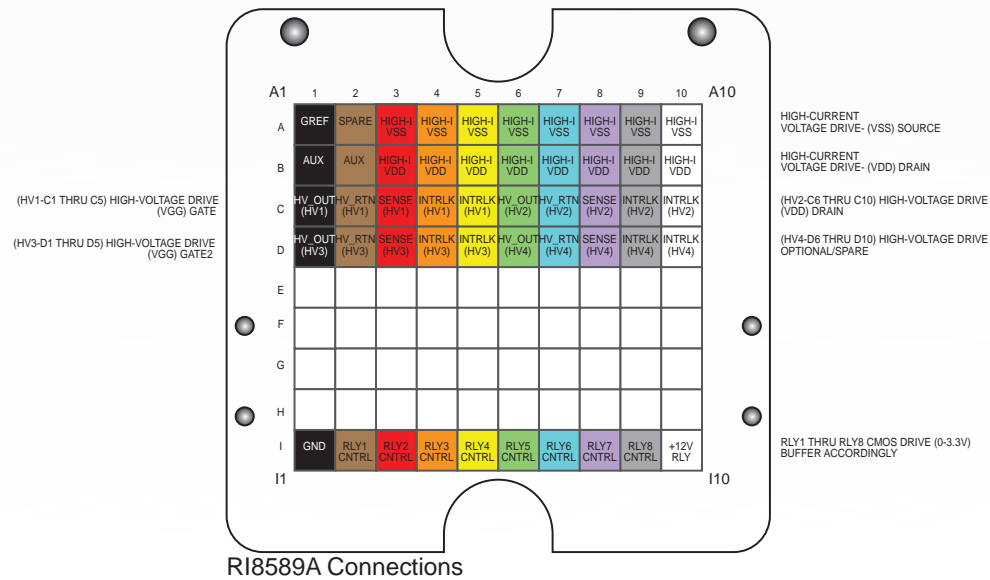
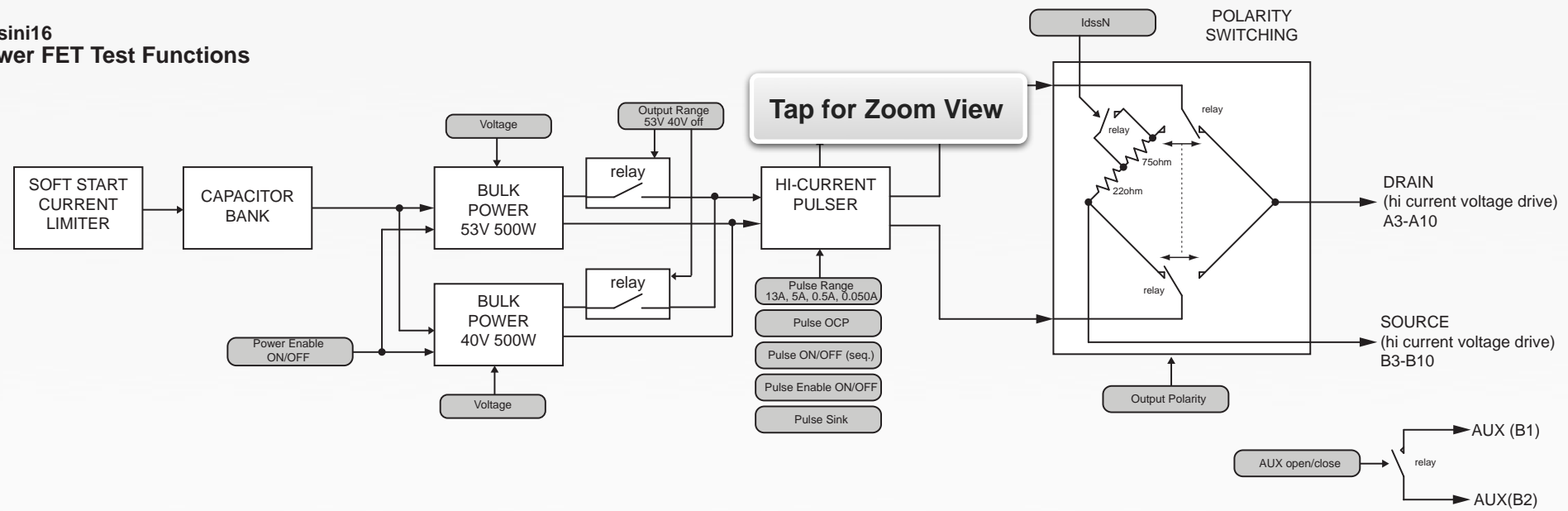
Model and Name as it appears in the Tester Configuration:

- FetPulser, RI8589x Fet Pulser

*NOTE: Multiple RI8589 instruments are enumerated incrementally by the system as “2”, “3”, etc. in the configuration, edit, and control panels (i.e - FetPulser, FetPulser 2, FetPulser 3, etc). The “x” in RI8589x denotes the model revision number.*

BLOCK DIAGRAM 2.1

Roos Instruments, Inc - Cassini16  
**Block Diagram, Bulk Power FET Test Functions**  
**RI589A4**  
 12-14-2015 rev E

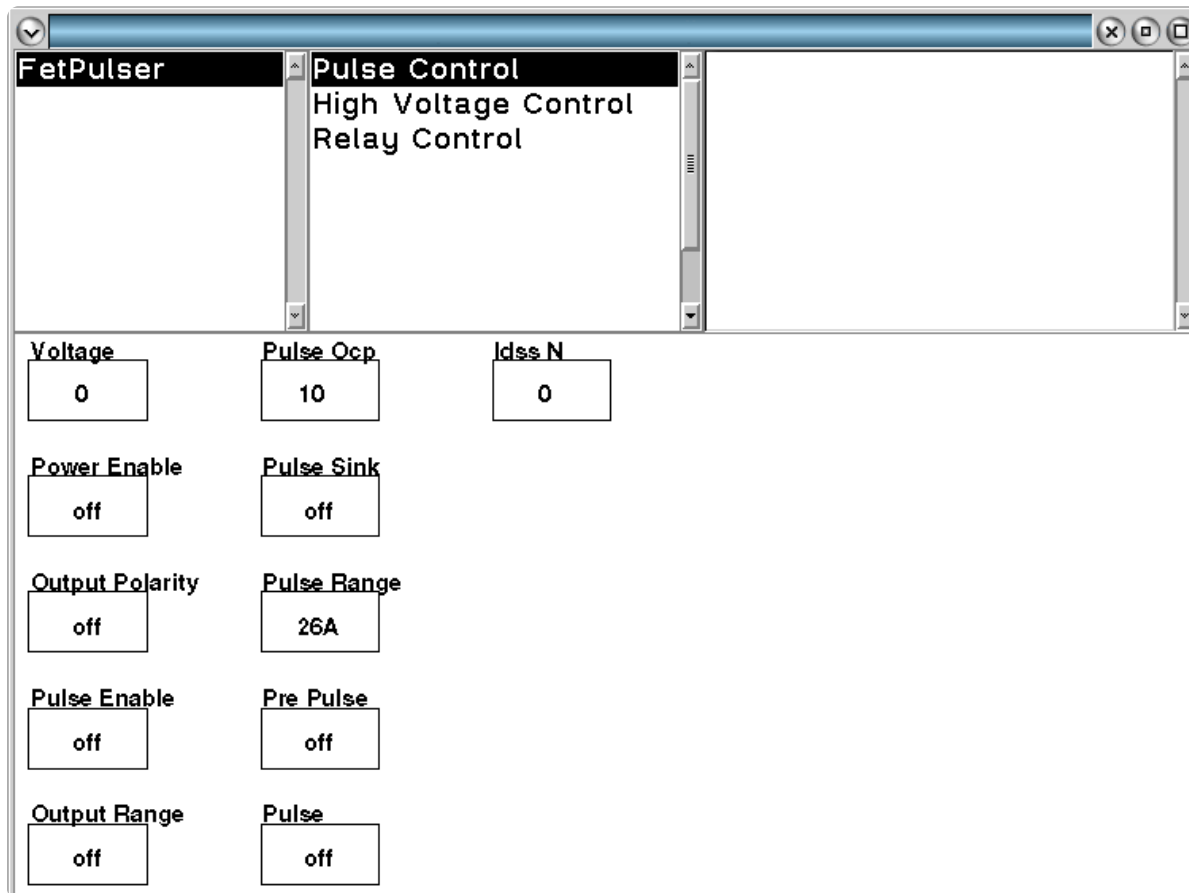


Copyright Roos Instruments, Inc.  
 Subject to change without notice

## EDIT PANELS

Graphical programming buttons and blocks are placed in test panels to define instrument control settings and measurements for this instrument.

### EDIT PANELS 21 RI8589: HIGH POWER SUPPLY/PULSER



Pulse Control buttons configure the high-current voltage pulse start time, pulse length, and voltage of the High-I VDD/VSS resources.



## PANEL: PULSE CONTROL

Voltage

0

### Voltage

Decimal notation input button that sets the amplitude value of the pulse on the *High-I VDD* resource. The value is in units of volts with an input range of 8V to 52V with a resolution of 20mV.

Power Enable

off

### Power Enable

Drop down list button that controls the internal power supply used in the pulse driver circuit. This button is used in conjunction with the **Voltage**, **Pulse Enable**, **Pulse**, and/or **Idss N** buttons.

‘on’ turns the internal supply on for normal operation.

‘off’ turns the internal supply off.

‘<18V’ configures the internal supply for low-voltage accuracy to support pulse values from 6V to 18V.

## Output Polarity

Drop down list button that sets the state of the *High-I VDD* and *High-I VSS* pins relative to the internal high power pulser and bulk power supplies via the polarity switching relays. See [Block Diagram 2.1](#).

‘pos’ routes the positive side of the internal power supplies to the *High-I VDD* pins and the negative (ground) terminal of the internal power supplies to the *High-I VSS* pins.

‘neg’ routes the positive side of the internal power supplies to the *High-I VSS* pins and the negative (ground) terminal of the internal power supplies to the *High-I VDD* pins.

‘off’ is the default mode and disconnects all internal resources from the *High-I VDD* and *High-I VSS* pins, leaving the pins in an open state.

‘aux’ disconnects the internal pulse driver and supplies from the *High-I VDD* and *High-I VSS* pins and closes the relay between the *Aux (B1)* input pin and the *Aux (B2)* output pin. This mode is used to route an auxiliary resource connected to the *Aux (B2)* input to the *Aux (B1)* output pin (that is typically connected in parallel to the *High-I VDD* pins).

‘test’ is for RI internal use only.

‘short’ configures the polarity relays to short the *High-I VDD* and *High-I VSS* pins together.

Output Polarity

off

‘zero’ connects the *High-I VSS* pins to ground (0V) and disconnects the *High-I VDD* from all internal circuits, leaving the resource pins floating.

Pulse Enable

off

## Pulse Enable

Drop down list button that controls the relays connecting the internal pulse drive circuit to the *High-I VDD/High-I VSS* pins. It is used in conjunction with the **Voltage** and **Pulse** buttons.

‘on’ closes the relay that connects the pulse driver circuit to the pin resources.

‘off’ opens the relay that connects the pulse driver circuit to the pin resources.

*NOTE: This button is commonly used in measure sequence groups to disconnect the pulse driver circuit load from the High-I-VDD/High-I VSS pins while concurrently measuring voltage, current, or temperature of the DUT.*

## Output Range

Drop down list button that sets the maximum output voltage range of the current pulser. This configures/connects the internal power supplies that drive the internal pulse circuitry.

'off' disconnects the internal power supplies from the pulse driver.

'40v' connects the internal 40 volt power supply to the pulse driver.

'53v' connects the internal 53 volt power supply to the pulse driver.

'hi current' connects both the 40 and 53 volt supplies in parallel with the added capacitor bank to supply the maximum current capacity. The maximum output voltage is 40 volts.

Output Range

off

## Pulse Ocp

Decimal notation input button that sets the peak current limit (Over Current Protection) on the pulse output in Amps. The maximum current is 26 Amps with a set resolution of ~100mA. This button is commonly used with the **Pulse**, **Pulse Enable**, and **Pulse Range** buttons.

Pulse Ocp

10

*NOTE: When the supplied current exceeds the Pulse Ocp value, the pulse driver circuit goes into shutdown by disconnecting from the output pins to prevent damage to the DUT. To recover from the pulse driver shutdown mode, the 'Pulse' button must set to 'off' or the Pre Pulse button must be set to 'Clr OCP' in the test panel.*

**WARNING: When the Pulse Range mode is set to '500mA' or '50mA', the Pulse Ocp button value should be set to a value less than or equal to the Pulse Range button to prevent damage to the sense resistors of the internal current measurement module.**

## Pulse Sink

Drop down list button that sets the pre-pulse current conditions on the *High-I VDD/High-I VSS* pins.

'off' is the default mode that disables any pre-pulse current.

'on' configures the *High-I VDD* pins to pull a constant 10mA from the output pins down to a voltage limit of -10V.

Pulse Sink

off



Pulse Range

26A

## Pulse Range

Drop down list button that sets the maximum expected current amplitude for pulsed measurements, optimizing the dynamic range of the internal ADC's input capture. This button is used with the **Pulse**, **Pulse Enable**, and **Pulse Ocp** buttons in conjunction with **Current** and **Current vs. Time** measurement blocks.

'26A' is the default mode and maximum absolute current range.

'10A' sets the dynamic range of the measurement with a maximum value of 10A.

'500mA' sets the dynamic range of the measurement with a maximum value of 500mA.

---

**WARNING: When the '500mA' mode is selected, the Pulse OCP button must be set to a value of 1A or less to prevent damage to the sense resistor of the internal current measurement module.**

---

'50mA' sets the dynamic range of the measurement with a maximum value of 50mA.

---

**WARNING: When the '50mA' mode is selected, the Pulse OCP button must be set to a value of 50mA to prevent damage to the sense resistor of the internal current measurement module.**

---

'cal' for RI internal use only

*NOTE: Exceeding the current of the Pulse Range value will result in erroneous computed values of measured current.*

Pre Pulse

off

## Pre Pulse

Drop down list button that connects in an internal load to the pulse driver circuit to stabilize voltage regulation for pulses less than 12 volts. Placing this button in a test panel with a value of 'on' with a **Pulse** button set to 'on' in a premeasure preloads the voltage source for 15ms.

'on' connects the internal load to the pulse driver before a pulse event.

'off' is the default mode that disconnects the internal load to the pulse driver before a pulse event.

'Clr OCP' re-initiates/reconnects the pulse driver circuit to the output pins after a current event exceeds the Pulse OCP value.

*NOTE: Without a load connected for voltage values less than 12V, typically the initial pulse voltage will be higher than the set value.*

## Pulse

Drop down list button that defines the start point of a pulse in a premeasure grouping and the stop point in a post measure group, effectively defining the pulse duration. It is used in conjunction with the **Voltage** and **Pulse Enable** buttons.

'on' initiates the pulse and is placed in a premeasure group with a sequence delay button to define the length of the pulse on condition.

'off' terminates the pulse and is placed in a pre or post measure group to define the endpoint of the pulse.

*NOTE: The Pulse button is only valid in premeasure and post measure groups.*

Pulse

off

## Idss N

Decimal notation input button that sets the current value for a drain diode test. This button overrides the voltage setting for the **Voltage** button to allow for the current value specified. This button sets the polarity switching relay network (see [Block Diagram 2.1](#)) to force current out of the *High-I VSS* resource pins and to sink the resulting

Idss N

0

current from the DUT's diode into the *High-I VDD* resource pins. The maximum current setting is 10A.

*NOTE: The voltage value on the High-I VSS resource in this mode is set by the series  $22\Omega$  resistance of the polarity switching network and the current setting of the Idss N button.*

**PANEL: HIGH VOLTAGE CONTROL****Hv 1**

Decimal notation input button that sets the *HV\_OUT (HV1)* resource pin voltage. The input value is in units of volts with a range of -10V to +65V and resolution of 5mV. This button is used in conjunction with the **Hv 1 Output** and **Hv 1 Current Range** buttons.

*NOTE: The HV\_OUT (HV1) [C1] and SENSE (HV1) [C3] pins must be connected on the device interface board to provide accurate voltage regulation.*

Hv 1

0

**Hv 1 Enable**

Drop down list button that controls the *HV1* high voltage generator.

'on' activates the high voltage generator.

'off' disables the high voltage generator.

Hv 1 Enable

on

**Hv 1 Output**

Drop down list button that controls the solid-state relay between the HV1 supply and *HV\_Out (HV1)* resource pin.

'off' disconnects the supply from the HV1 resource pin.

'on' connects the HV1 supply to its output pin.

*NOTE: The INTRLK (HV1) [C4] and INTRLK (HV1) [C5] interlock pins must be connected by a device interface board to enable voltage output on the HV\_Out (HV1) pin.*

Hv 1 Output

off

**Hv 1 Current Range**

Drop down list button that selects the maximum expected current for the *HV1* power supply for optimum measurement dynamic range. This is used to select an internal sense resistor for measuring current on the supply resource.

'20 mA' selects the sense resistor for a maximum expected current of 20mA.

Hv 1 Current Range

20 mA

'10 mA' selects the sense resistor for a maximum expected current of 10mA.

'1 mA' selects the sense resistor for a maximum expected current of 1mA.

'100 uA' selects the sense resistor for a maximum expected current of 100µA.

'cal' is for RI internal use only.

Hv 2  
0

## Hv 2

Decimal notation input button that sets the *HV\_OUT (HV2)* resource pin voltage. The input value is in units of volts with a range of -5V to +185V and resolution of 20mV. This button is used in conjunction with the **Hv 2 Output** and **Hv 2 Current Range** buttons.

*NOTE: The HV\_OUT (HV2) [C6] and SENSE (HV2) [C8] pins must be connected on the device interface board to provide accurate voltage regulation.*

## Hv 2 Enable

Drop down list button that controls the *HV2* high voltage generator.

'on' activates the high voltage generator.

'off' disables the high voltage generator.

Hv 2 Enable

on

## Hv 2 Output

Drop down list button that controls the solid-state relay between the HV2 supply and *HV\_Out (HV2)* resource pin.

'off' disconnects the *HV2* supply from the resource pin.

'on' connects the *HV2* supply to the resource pin.

*NOTE: The INTRLK (HV2) [C9] and INTRLK (HV2) [C10] interlock pins must be connected by a device interface board to enable voltage output on the HV\_Out (HV1) pin.*

Hv 2 Output

off

**Hv 2 Current Range**

20 mA

**Hv 2 Current Range**

Drop down list button that selects the maximum expected current for the *HV2* power supply for optimum measurement dynamic range. This is used to select an internal sense resistor for measuring current on the supply resource.

'20 mA' selects the sense resistor for a maximum expected current of 20mA.

'10 mA' selects the sense resistor for a maximum expected current of 10mA.

'1 mA' selects the sense resistor for a maximum expected current of 1mA.

'100 uA' selects the sense resistor for a maximum expected current of 100µA.

'cal' is for internal RI use only.

**Hv 3**

0

**Hv 3**

Decimal notation input button that sets the *HV\_OUT (HV3)* resource pin voltage. The input value is in units of volts with a range of -10V to +65V and resolution of 5mV. This button is used in conjunction with the **Hv 3 Output** and **Hv 3 Current Range** buttons.

'off' disconnects the *HV3* supply from the resource pin.

'on' connects the *HV3* supply to the resource pin.

*NOTE: The HV\_OUT (HV3) [D1] and SENSE (HV3) [D3] pins must be connected on the device interface board to provide accurate voltage regulation.*

**Hv 3 Enable**

on

**Hv 3 Enable**

Drop down list button that controls the HV3 high voltage generator.

'on' activates the high voltage generator.

'off' disables the high voltage generator.

## Hv 3 Output

Drop down list button that controls the solid-state relay between the HV3 supply and *HV\_Out (HV3)* resource pin.

Hv 3 Output

off

*NOTE: The INTRLK (HV3) [D4] and INTRLK (HV3) [D5] interlock pins must be connected by a device interface board to enable voltage output on the HV\_Out (HV1) pin.*

## Hv 3 Current Range

Drop down list button that selects the maximum expected current for the HV3 power supply for optimum measurement dynamic range. This is used to select an internal sense resistor for measuring current on the supply resource.

'20 mA' selects the sense resistor for a maximum expected current of 20mA.

'10 mA' selects the sense resistor for a maximum expected current of 10mA.

Hv 3 Current Range

20 mA

'1 mA' selects the sense resistor for a maximum expected current of 1mA.

'100 uA' selects the sense resistor for a maximum expected current of 100µA.

'cal' is for internal RI use only.

Measure

Hv1 V

## Measure

Drop down list button that selects the resource and measurement type. See [Example E](#) measurement test panels.

'Hv1 V' measures voltage of the *HV1* supply and is commonly used with the **Voltage** and **Voltage vs Time** measurement blocks.

'Hv1 Vlo' measures voltage on the *HV1* supply using the enhanced sensitivity mode for improved accuracy of voltage values less than 10V. This setting is commonly used with the **Voltage** and **Voltage vs Time** measurement blocks.

'Hv1 I' measures the current of the *HV1* supply and is commonly used with the **Current** and **Current vs Time** measurement blocks.

'Hv2 V' measures voltage of the *HV2* supply and is commonly used with the **Voltage** and **Voltage vs Time** measurement blocks.



'Hv2 Vlo' measures voltage on the *HV2* supply using the enhanced sensitivity mode for improved accuracy of voltage values less than 20V. This setting is commonly used with the **Voltage** and **Voltage vs Time** measurement blocks.

'Hv2 I' measures the current of the *HV2* supply and is commonly used with the **Current** and **Current vs Time** measurement blocks.

'Hv3 V' measures voltage of the *HV1* supply and is commonly used with the **Voltage** or **Voltage vs Time** measurement blocks.

'Hv3 Vlo' measures voltage on the *HV3* supply using the enhanced sensitivity mode for improved accuracy of voltage values less than 10V. This setting is commonly used with the **Voltage** or **Voltage vs Time** measurement blocks.

'Hv3 I' measures the current of the *HV3* supply and is commonly used with the **Current** or **Current vs Time** measurement blocks.

'Pulse V' measures the pulse voltage across the *High-I VDD* and *High-I VSS* resource path via the internal pulse driver circuit. This setting is commonly used with the **Voltage** or **Voltage vs Time** measurement blocks.

'Pulse V Low' measures pulse voltage across the *High-I VDD* and *High-I VSS* resources via the internal pulse driver circuit using the enhanced sensitivity mode for improved accuracy of voltage values less than 5V. This setting is commonly used with the **Voltage** or **Voltage vs Time** measurement blocks.

'Pulse I' measures the pulse current flowing through the *High-I VDD* and *High-I VSS* resource path via the internal pulse driver circuit. This setting is commonly used with **Pulse**, **Pulse Enable**, and **Pulse OCP** buttons in conjunction with **Current** or **Current vs Time** measurement blocks.

'VdssN' measures the voltage across the *High-I VDD* and *High-I VSS* resources. This setting is commonly used with the **Voltage** or **Voltage vs Time** measurement blocks.

'IdssN' measures the pulsed current through the *High-I VDD* and *High-I VSS* resource path with a DUT's diode on. This setting is commonly used with **Current** or **Current vs Time** measurement blocks.

'Temp' returns the computed temperature using the DUT as a temperature diode during a pulse event on the *High-I VDD* and *High-I VSS* resource path. This setting is used with the **Voltage** or **Voltage vs Time** measurement blocks which return a temperature value. A **Convert** button from the 'System > General Calculation' instrument is required to convert the datatype to an RiTemperature when saving to the worksheet in units of degree C.

*NOTE: Because the absolute temperature characteristics of different DUTs vary, the 'Temp' mode is used for computing relative temperature change (heating and cooling effects) between successive measurements of the DUT.*

Delay

0

## Delay

A decimal notation input button that defines the duration of time between the **Trigger: start** and the **Voltage vs. Time** measurement capture start. The value of the Delay button therefore defines the MIN X value of the plot window.

*NOTE: Feature only available on RI8589B models.*

Trigger

off

## Trigger

Drop down list button that is used within a pre-measure group to initiate a trigger for **Voltage vs. Time** or **Current vs. Time** measurements. The 'start' option initiates the capture collection. The 'off' disables the trigger. This button is used in conjunction with the **Trigger Ref**, **Trigger Spacing**, and **Meas Ref** buttons found in the System instrument.

*NOTE: Feature only available on RI8589B models.*

Meas Width

1000 u

## Meas Width

Decimal notation input button that defines the duration of the capture window of **Voltage vs. Time** or **Current vs. Time** measurements in units of seconds at a fixed capture rate of 1Msps.

*NOTE: Feature only available on RI8589B models.*

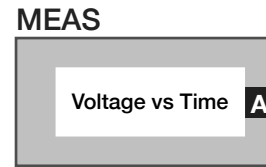
MEAS

Voltage

A

## Meas: Voltage

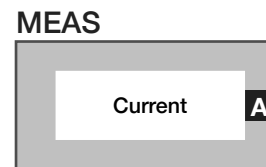
Measurement block that returns the voltage from the resource designated by the **Measure** button as a 'RiVoltageD' datatype. This block is used in conjunction with the *FETPulser* instrument's **Meas Rate** button and the *System* instrument's **Averages** button to define the measurement capture parameters.



## Meas: Voltage vs Time

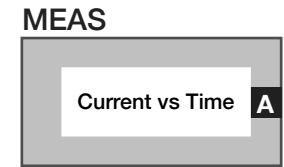
Measurement block that returns a voltage value indexed by time from the resource designated by the **Measure** button as a 'RiVoltageVsTimeInt' datatype. This block is used in conjunction with the *FETPulser* instrument's **Meas Rate**, **Trigger** and **Delay** buttons to define the measurement capture parameters.

*NOTE: Feature only available on RI8589B models.*



## Meas: Current

Measurement block that returns the current from the resource designated by the **Measure** button as a 'RiCurrentD' datatype. This block is used in conjunction with the *FETPulser* instrument's **Meas Rate** button and the *System* instrument's **Averages** button to define the measurement capture parameters.



## Meas: Current vs Time

Measurement block that returns a current value indexed by time from the resource designated by the **Measure** button as a 'RiVoltageVsTimeInt' datatype. This block is used in conjunction with the *FETPulser* instrument's **Meas Rate**, **Trigger** and **Delay** buttons to define the measurement capture parameters.

*NOTE: Feature only available on RI8589B models.*

## PANEL: RELAY CONTROL

---

Relay 1

off

### Relay 1

Drop down list button that provides a relay control voltage of +5V on the *RLY1 CNTRL [I2]* pin. The drive current capacity is 8mA.

*NOTE: Relay GND pins must be connected to the external relay circuit to provide a return path. The 12V [I10] pin provides the supply for an external electromechanical relay.*

### Relay 2/3/4/5/6/7/8

See **Relay 1** description as it applies to the corresponding relay.

EXAMPLE E RI8589 TESTPLAN EXAMPLES

The screenshot shows a graphical programming environment. The top menu bar includes File, Edit, Tester, Limits, Options, Debug, and Help. The left sidebar lists test plan settings, with 'Test: HV1 Voltage Set; Measure Current' highlighted. The main workspace contains a block diagram. On the left, there are four 'FetPulser' blocks: 'Hv 1' (value 50), 'Hv 1 Enable' (value on), 'Hv 1 Output' (value on), and 'Hv 1 Current Range' (value 20 mA). In the center, a 'Measure' block contains 'FetPulser Measure' (value Hv1 I) and 'FetPulser MEAS' (value Current A). A line connects the 'Current A' block to a 'System Save Amps' block labeled 'HV1\_current'. The bottom left corner shows a timestamp: '05/10/17 at 11:07:52 am'. On the right side of the window, there are buttons for 'Compile', 'Run', 'Repeat', and 'Retest'.

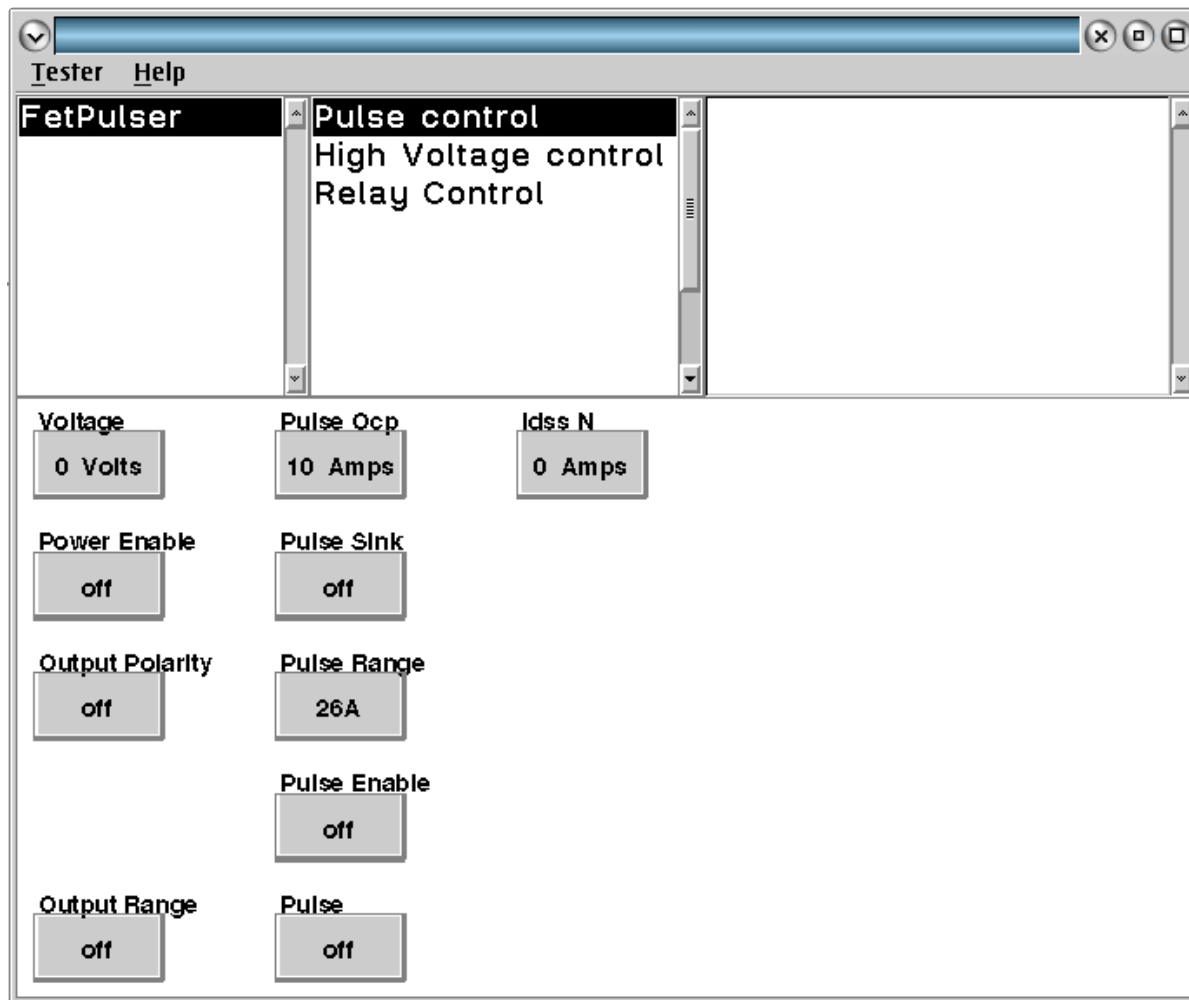
The above example demonstrates how to set the HV1 supply to 50V and measure the current flowing through HV1.



## CONTROL PANELS

Real time control of the instruments in this TIM.

### CONTROL PANELS 16 RI8589: HIGH POWER SUPPLY/PULSER



Pulse Control allows real-time control of the High-I VDD/VSS pulse settings.





# RI8594: HIGH PERF. WAVEFORM GENERATOR & MEASURE



## TOPICS

---

[Instruments Provided by this TIM](#)

[Configuration Panel](#)

[Instrument Diagram with Edit Buttons](#)

[Edit Panel Button Descriptions](#)

[Control Panel](#)

Tap the links above to quickly access content

## INSTRUMENTS PROVIDED BY THIS TIM

The instrument in this TIM appear as **LowNoiseClock**, **Oscilloscope**, **SineGen**, and **Waveform** in the panel dialog windows.

Model and Name as it appears in the Tester Configuration:

- LowNoiseClock, Ri8585x Low Noise Source
- Oscilloscope, RI74105x Hi Spd scope/counter/BER
- SineGen, Ri7403x Dual Sine Source
- Waveform, Ri74211x Complex Waveform

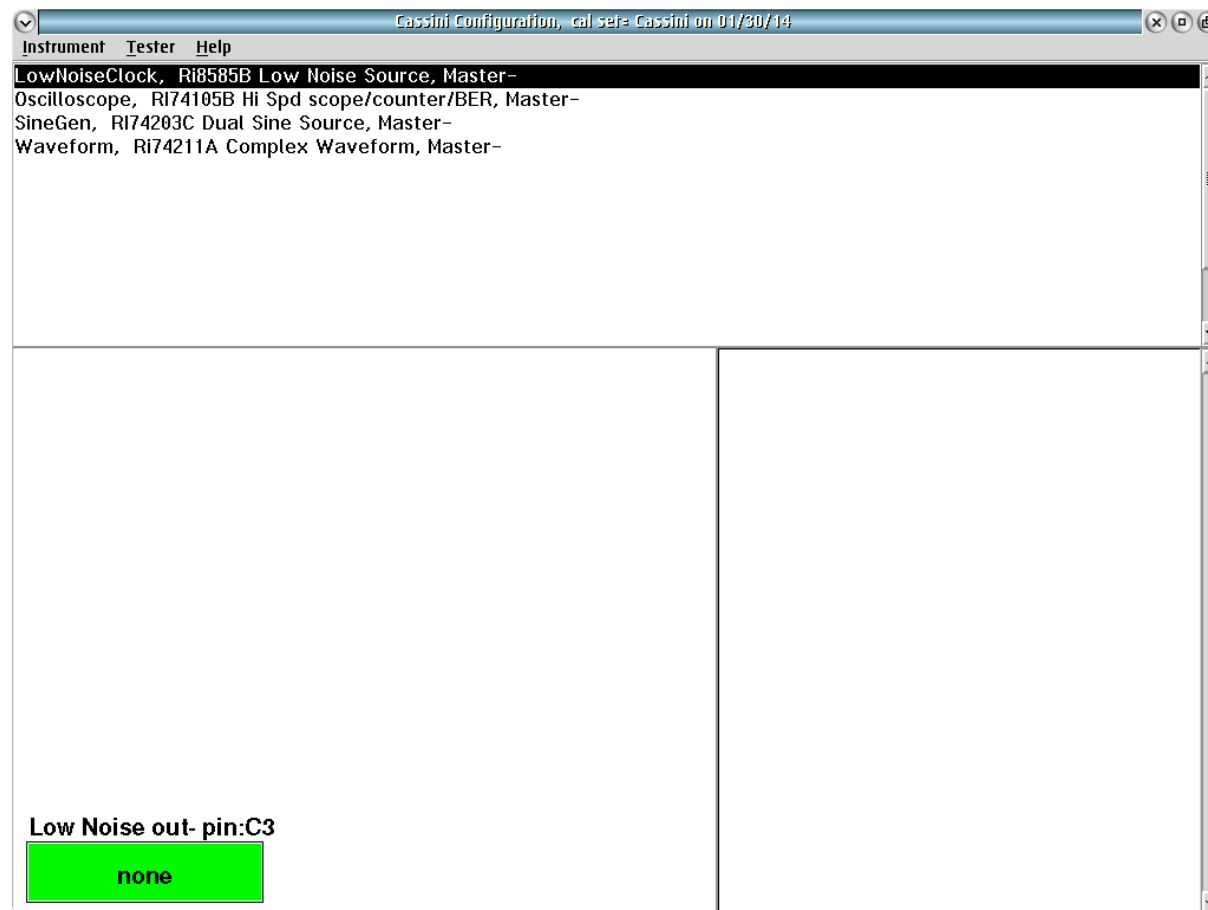
*NOTE: Multiple RI8594 instruments are enumerated incrementally by the system as “2”, “3”, etc. in the configuration, edit, and control panels (i.e - Oscilloscope, SineGen, Waveform, LowNoiseClock; Oscilloscope2, SineGen2, Waveform2, LowNoiseClock2; Oscilloscope3, SineGen3, Waveform3, LowNoiseClock3, etc).*

*The “x” in RI8594x denotes the model revision number.*

## CONFIGURATION PANELS

Configure the Instruments in this TIM.

### CONFIGURATION PANELS 6 RI8572: WAVEFORM GENERATOR & MEASURE



LowNoiseClock shows connections from this instrument.



## LOWNOISECLOCK

The LowNoiseClock instrument provides one resource allocation in the configuration panel: **Low Noise out-pin:C3**.

*NOTE: Green buttons can only be configured with a fixture definition.*

## OSCILLOSCOPE

The Oscilloscope instrument provides two resource allocations in the configuration panel: **Wf7 Scope Ch2 RE-pin:C5** and **Wf6 Scope Ch1 IM-pin:C1**.

*NOTE: Green buttons can only be configured with a fixture definition.*

## SINEGEN

The SineGen instrument provides two resource allocations in the configuration panel: **Wf9 Sine Out- pin:C8** and **Wf8 Sine Out-pin:C4**.

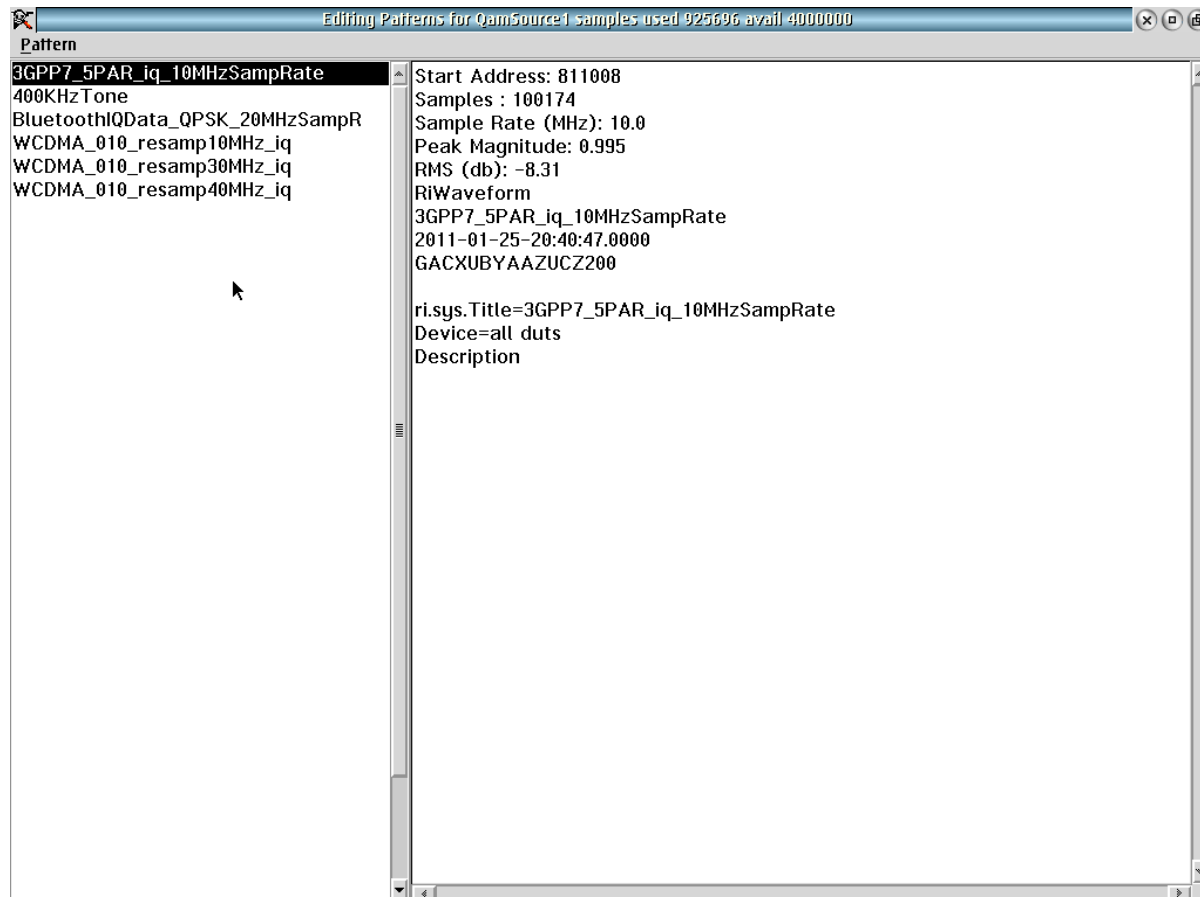
*NOTE: Green buttons can only be configured with a fixture definition.*

## WAVEFORM

The Waveform instrument provides three resource allocations in the configuration panel: **Edit Patterns, Wf 3, Wf 2**.

*NOTE: Green buttons can only be configured with a fixture definition.*

**IMAGE 2.1 EDIT PATTERNS DIALOG**

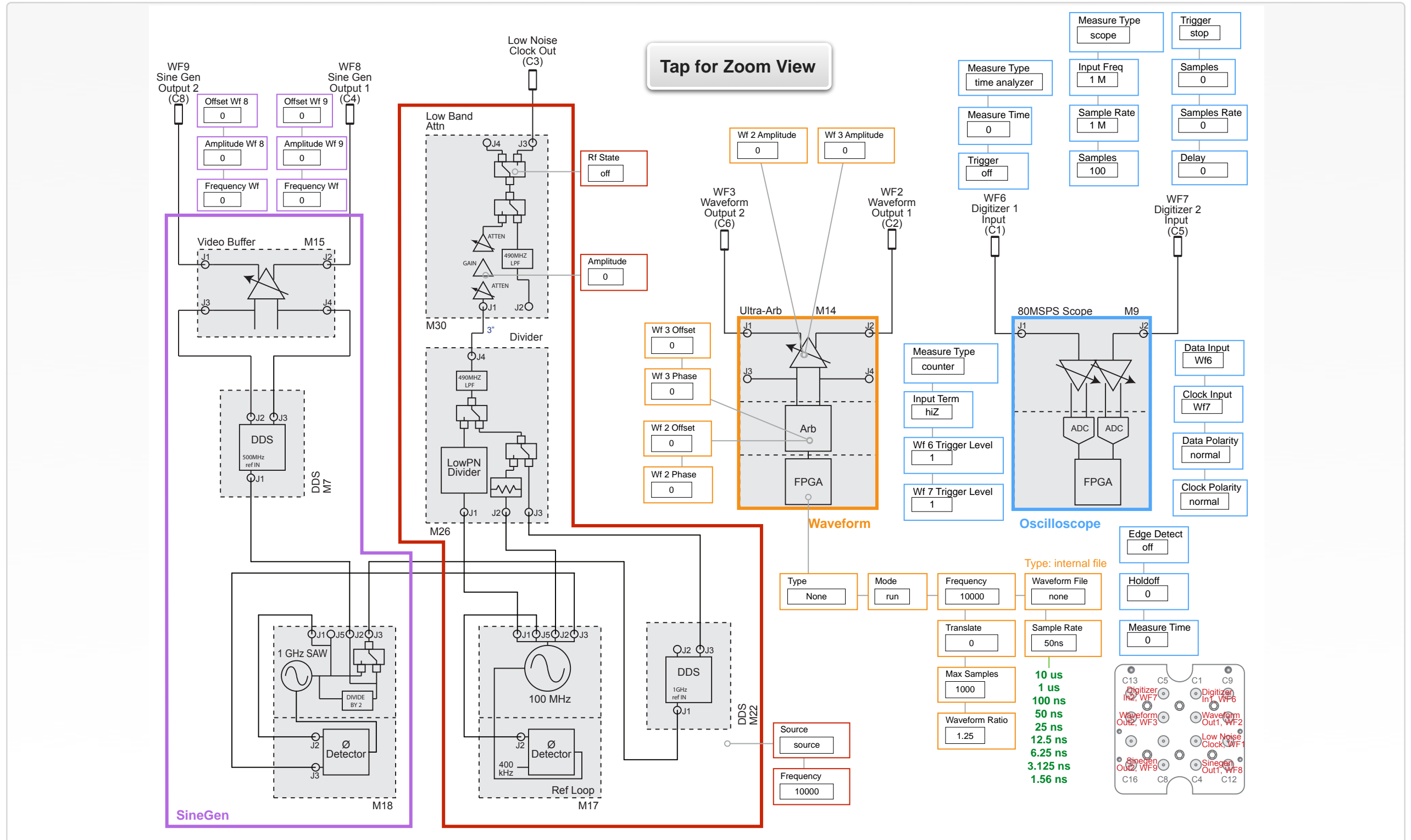


## Edit Waveforms

This button displays the current waveform/pattern loaded into the Waveform's arbitrary waveform generator. Clicking on the button opens the Edit Patterns window (See [Image 2.1](#)). The left pane of the Edit Patterns window displays a list of all waveforms that have been loaded into the instruments on-board memory. Selecting any of these waveforms displays more information in the right pane: start address in memory, number of samples, sample clock rate, peak magnitude, RMS magnitude indB, and more information about the original waveform file from Guru. New waveforms can be added to the list using the Pattern pull down menu at the top left of the window and then selecting "add from Guru." The user can specify a different pattern name from the Guru version for test program purposes.

*NOTE: Waveforms are programmed into memory sequentially. While waveforms can be removed from the list view by selecting them and using the menu option "Pattern > remove", they are not erased from the memory. To make used memory available again, all waveforms must be purged using the "Pattern > Erase > All Patterns" menu option.*

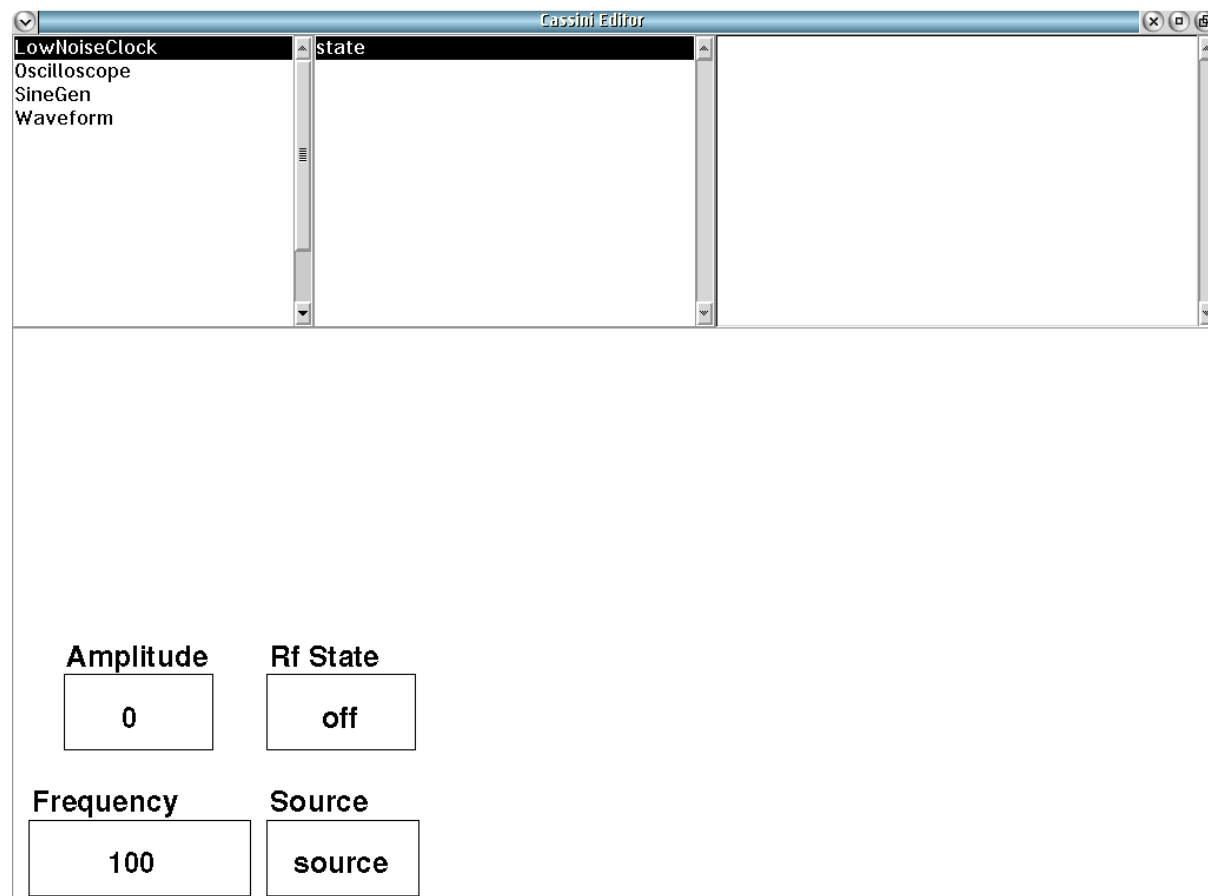
INSTRUMENT BUTTON DIAGRAM 2.13



## EDIT PANELS

Automated control of the instruments in this TIM with use by the Test Plan Editor.

### EDIT PANELS 22 RI8572: WAVEFORM GENERATOR & MEASURE



## LOWNOISECLOCK

### PANEL: STATE

Frequency

### Frequency

Decimal notation input button that sets the source output frequency in MHz. The frequency range is 0 to 400 MHz.

*NOTE: The button's value is dependent on the Source button selected. For frequency values between 0 to 100 MHz, for 100 MHz it is 100 MHz and with a the divider, it is 5, 6.25, 10, 12.5, 20, 25, 50 MHz.*

Amplitude

### Amplitude

Decimal notation input button that sets the low-noise clock signal amplitude in units of dBm. The range of valid input values are -60 to +10.



## Rf State

Drop down list button makes the clock signal active ('on') or inactive ('off') at the clock output port located at position C3 of the instrument test head.

Rf State

off

## Source

Drop down list button that sets the reference source for the low-noise clock.

The 'source' option selects the Direct Digital Synthesizer (DDS) that sources frequency values between 200 Hz to 400 MHz.

The '100 MHz' option selects the ultra-low phase noise 100 MHz crystal oscillator.

The 'divider' option selects the 100 MHz crystal oscillator with frequency division to provide the highest phase noise performance at set frequency values of 5, 6.25, 10, 12.5, 20, 25, 50 and 100 MHz.

*NOTE: The typical phase noise performance of the 100 MHz oscillator is approximately 148 dBc/Hz. The 'divider' option has typical noise performance of approximately  $148 \text{ dBc/Hz} + 20 \log(100 \text{ MHz/Frequency}) \text{ dBc/Hz}$ .*

Source

source

## OSCILLOSCOPE

### PANEL: SCOPE

Measure Type

counter

### Measure Type

Drop down list button that sets the operation type for the oscilloscope instrument. This button is found in the 'scope', 'counter/ber', and 'time analyzer' subsystem panes of the oscilloscope. Buttons and blocks found in these subsystem panes are settings or parameters used by the corresponding function choice of this button. The description of each function is as follows:

The 'scope' setting is an oscilloscope function optimized for signal capture of sinusoidal waveforms from 1 Hz to 80 MHz.

The 'digitizer' setting is a digitizing oscilloscope function for arbitrary signals from 1 Hz to 80 MHz.

The 'counter' setting performs frequency counting operation of sinusoidal, square-wave, and pulse signals. This function requires a voltage reference or trigger and several periods of the input signal to accurately compute signal frequency.

The 'time analyzer' setting performs timing computations of signal events using a trigger and a user-defined measurement timing window.

The 'ber' setting performs a bit error rate calculation. A predefined, pseudo-random gray code bit stream is emitted from the user-selected port. The digitizer captures the return signal after a user-specified wait or trigger time and then calculates the bit error rate.

The 'reciprocal' setting performs a signal frequency count using a reciprocal count method optimized for faster computation of signals below 1 MHz. The reciprocal counter uses the input signal as a trigger and counts the internal clock edges across one period of the input signal.

Input Freq

1 M

### Input Freq

Decimal notation input button that sets the frequency of the expected input signal in units of Hz. The expected input frequency value enables accurate signal reconstruction of input signals with frequency values greater than the Nyquist sample rate of the oscilloscope.

*NOTE: This button enables a Cassini system compiler directive to compensate for signal path calibrations for a known frequency value.*

## Samples

Decimal notation input button that sets the total number of samples in the oscilloscope capture window.

*NOTE: Maximum number of samples is 2000.*

Samples

100

## Sample Rate

Decimal notation input button that sets the oscilloscope's sample rate in units of Hz.

*NOTE: Maximum sample rate is 80 mS/s*

Sample Rate

1 M

## MEAS

Complex vs Time **A**

## Meas: Complex vs Time

Measurement block that computes an RiComplex Voltage vs Time result as a 'RiComplexVVsTimeInt' datatype. Using port WF7 as the real (in-phase) signal component and the WF6 port as the imaginary (quadrature) signal component, the block computes a voltage vector representation of an I/Q baseband signal by digitizing each channel independently and then time-interleaving the channels.

**PANEL: COUNTER/BER**

Measure Time

0

**Measure Time**

Decimal notation input button that sets the measurement window for counter measurement gating in units of seconds. Maximum time limit is 2000\***Sample Rate**.

Edge Detect

off

**Edge Detect**

Drop down list button that sets the edge detector mode. Option 'off' deactivates edge detection. The 'rising' option sets the detector to generate edges, trigger, or count on rising edge event types in the data input. The 'both' option sets the detector to generate edges, trigger, or count on both rising and falling edge event types in the data input.

*NOTE: This button must be set to either 'rising' or 'both' for event counting.*

Data Polarity

normal

**Data Polarity**

Drop down list button that sets the data input polarity for counter or bit error rate measurements. The 'normal' option is positive or rising edge count/trigger. The 'inverted' option is falling or negative edge count/trigger.

Data Input

Wf6

**Data Input**

Drop down list select button that selects the instrument resource port for measurements. The option 'Wf6' sets WF6, located at port position C1 on the instrument head, as input to the digitizer. The option 'Wf7' sets WF7, located at port position C5 on the instrument head, as input to the digitizer. The option 'off' internally disconnects all input ports/paths from the digitizer instrument.

Clock Polarity

normal

**Clock Polarity**

Drop down list button that sets the polarity of the clock. The 'normal' option is positive or rising edge count/trigger. The 'inverted' option is falling or negative edge count/trigger.

### Clock Input

Drop down list select button selects the clock input for bitt error rate measurements. The 'Wf6' sets the signal available at the WF6 port located at position C5 on the instrument head as the clock input. The 'Wf7' sets the signal available at the WF7 port located at position C1 on the instrument head as the clock input. The 'off' option uses the instruments internal clock.

Clock Input

### Wf 7 Trigger Level

Decimal notation input button that sets the trigger comparator level voltage for WF7. Valid range of values between  $\pm 0.4$  V.

Wf7 Trigger Level

### Wf 6 Trigger Level

Decimal notation input button that sets the trigger comparator level voltage for WF6. Valid range of values between  $\pm 0.4$  V

Wf6 Trigger Level

### Input Term

Drop down list button sets the input termination value to 'hiZ' representing a high impedance value of 10 k $\Omega$  or '50 ohm' for 50  $\Omega$ .

Input Term

### Holdoff

Decimal notation input button that sets the time in seconds that the edge/gate is disabled after sensing a trigger event. The range of values can be set between 25  $\mu$ s and 150 ns.

Holdoff

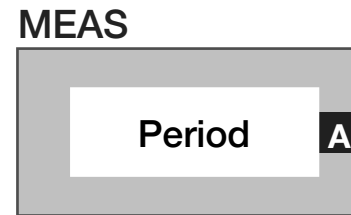
*NOTE: Typically set to the rise time of the edge.*

### Meas: Frequency

Measurement block that computes signal frequency of the selected input port set by **Data Input** button as a 'RiFrequency' datatype. The **Measure Time** button sets the capture window time.

MEAS  
 **A**

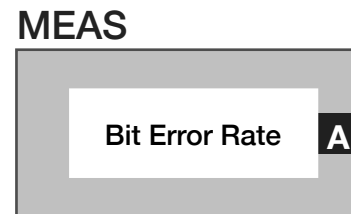
*NOTE: A minimum of two edge/rise or fall time events is required for accurate frequency count.*



### Meas: Period

Measurement block that computes the time between signal edges of the selected input port set by **Data Input** button as a 'RiTimeD' datatype. The block uses the **Measure Time** button to set the capture window time.

*NOTE: A minimum of two edge/rise or fall time events is required for accurate period measurement.*



### Meas: Bit Error Rate

Measurement block computes the ratio of errors to bits in a bitstream of the selected input port set by **Data Input** button as a 'RiFrequency' datatype. The **Measure Time** button sets the capture window time.

## PANEL: DIGITIZER

Delay

### Delay

Decimal notation input button that sets the delay in units of seconds with a resolution of 1  $\mu$ s before a digitizer measurement or to offset the start of a record. Maximum delay value is  $2000 \times \text{Sample Rate}$ .

Sample Rate

### Sample Rate

Decimal notation input button that sets the digitizer sample rate in Hz. The valid sample rate range is 1Hz to 80MHz.

Trigger

### Trigger

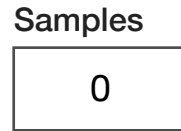
Drop down list button that is used within a pre-measure group to set the start and stop times of signal captures or bit error rate measurements. The 'start' option triggers an event collection. The 'off' option ends the event collection.

*NOTE: This button is used in conjunction with triggered measurements types.*



### Samples

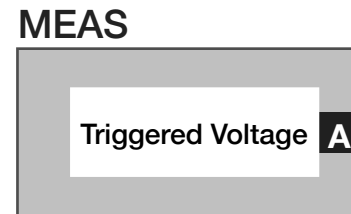
Decimal notation input button that sets the measurement record length for the digitizer.



*NOTE: Maximum number of samples is 2000.*

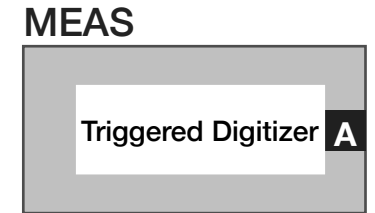
### Meas: Triggered Voltage

Measurement block computes a single voltage vector sample from an I/Q input signal voltage vector using a pre-measure group trigger button as a 'RiComplexVVsTimeInt' datatype. The sample point is set by the system measure reference plus any user specified delay using the **Delay** button. The block generates a single RiComplexVoltage value.



### Meas: TriggeredDigitizer

Measurement block computes multiple samples of an I/Q input signal's voltage vector using a pre-measure group trigger button as a 'RiComplexVVsTimeInt' datatype. Sample points begin at the system measure reference plus any user specified delay using the **Delay** button. The block computes and time-interleaves the two signal channels into RiComplexVoltage values.



**PANEL: TIME ANALYZER**



**Trigger**

Drop down list button that is used within a pre-measure group to set the start and stop times of signal captures or bit error rate measurements.

The 'start' option triggers an event collection.

The 'stop' option ends the event collection.

The 'berStart' option triggers an event collection for bit error rate measurements. This is used in conjunction with the **Bit Error Rate** measurements block and **Wf6 Trigger Level** and/or **Wf7 Trigger Level** button/s.

The 'berStop' option ends an event collection for bit error rate measurements. This is used in conjunction with the **Bit Error Rate** measurements block and **Wf6 Trigger Level** and/or **Wf7 Trigger Level** button/s.

*NOTE: This button is used in conjunction with triggered measurements types.*

**Measure Time**

Measure Time



Decimal notation input button that sets the measurement window for counter measurement gating in units of seconds. Maximum time limit is 2000 samples\***Sample Rate**

MEAS



**Meas: Triggered Time Stamp**

Measures events from the counter system. Generates as a 'RiTimeD' datatype with an entry for each edge. Measure is started and stopped by the Trigger in the pre-measure. Uses MeasureTime for the length to examine. Samples must exceed the measure time such that several samples occur after the time completes.

## WAVEFORM

### PANEL: STATE

---

Wf3 Amplitude

### Wf 3 Amplitude

Decimal notation input button that sets the amplitude of the open circuit peak voltage of the in-phase (real) signal component. The signal is available at WF3 located at position C6 on the instrument head. Maximum value is 2.5 volts peak.

Wf3 Phase

### Wf 3 Phase

Decimal notation input button that sets the waveform delay in units of degrees of the in-phase (real) signal at WF3 located at position C6 on the instrument head. The range of values is  $\pm 180$ .

Wf3 Offset

### Wf 3 Offset

Decimal notation button that sets the signal offset voltage for the waveform at WF3 located at position C6 on the instrument head. Available range is  $\pm 3$  V.

*NOTE: The output waveform plus the offset cannot exceed  $\pm 3$  volts.*

Wf2 Amplitude

### Wf 2 Amplitude

Decimal notation input button that sets the amplitude of the open circuit peak voltage of the quadrature (imaginary) signal component. The signal is available at WF2 located at position C2 on the instrument head. Maximum value is 2.5 volts peak.

Wf2 Phase

### Wf 2 Phase

Decimal notation input button that sets the waveform delay in units of degrees of the quadrature (imaginary) signal at WF2 located at position C2 on the instrument head. The range of values is between  $\pm 180$  degrees.

## Wf 2 Offset

Decimal notation button that sets the signal offset voltage for the waveform at WF2 located at position C2 on the instrument head. Available range is between  $\pm 3$  V.

Wf2 Offset

0

*NOTE: The output waveform plus the offset cannot exceed  $\pm 3$  volts.*

## Frequency

Decimal notation input button that sets the waveform frequency in units of Hz. When modulating the signal/s this button sets the center frequency. The valid input values are 1000 to 35000000 (1 kHz to 35 MHz).

Frequency

100000

Translate

0

## Translate

Decimal notation input button that generates two sinusoidal tones on WF2 and/or WF3 on either side of the **Frequency** button value by a user-defined value in units of Hz. For example, a **Frequency** value of

1 MHz and a **Translate** value of 100 kHz generates tones at 900 kHz and 1.1 MHz. Range of **Frequency**  $\pm$  **Translate** values must remain between 1 Hz - 20 MHz.

*NOTE: The translate button provides direct control of the arbitrary waveform generator's DDS and can be used to generate a sinusoidal signal on WF2/WF3 up to 80 MHz by setting the Sample Rate button to '1.56 ns', the Frequency button to 0 Hz, and the Wf2/Wf3 Amplitude button to the desired level. This multipurpose feature can also be used to generate low frequency, two-tone signals for intermodulation measurements.*

## Type

A drop down list button that outputs a two-channel, baseband waveform on WF2 (quadrature/imaginary) and WF3 (in-phase/real) from built-in modulation waveform types:

'Quad' - Quadrature sinusoidal waveforms (WF3 leads WF2 in phase by 90 degrees).

'Fast Quad' - This mode is no longer supported.

'Sine' - produces a sinusoidal waveforms on WF6 and/or WF7 with parameters defined by the user.

'Dual Sine' - This mode is no longer supported.

Type

none

“SSB Dual Sine” - Single sideband, dual sine waves on WF6/WF7. This mode produces two sinusoidal waveforms on a single channel specified by the user with Frequency 1= **Frequency** setting, and Frequency 2=**Frequency** \* **Frequency Ratio**.

‘SqWave’ - produces a square-wave signal on WF6 and/or WF7 with parameters defined by the user.

‘modulation’ - produces a modulated waveform using the button parameters found in the modulation pane of the waveform instrument.

‘file’ - This mode is no longer supported.

‘internal file’ - enables a user-defined signal specified by the **Waveform File** button in the edit panel. The list of waveforms in the **Waveform File** button can be edited by adding or removing waveform files to the TIM from Guru via the **Edit Patterns** button in the Configuration Panel.

Waveform Ratio

1.25

## Waveform Ratio

Decimal notation input button that used with the ‘SSB Dual Sine’ mode to generate two sinusoidal tones at frequency values that are a ratio value of each other on a single channel for WF6 or WF7. For example, a **Frequency** value of 2 MHz and **Waveform Ratio** of 1.25

produces a tone at 2 MHz and 2.5 MHz. Range of valid inputs is 1 to 2.

Sample Rate

50 ns

## Sample Rate

A drop down list button that sets the time between the waveform data’s next sample output. Sample rates options are “10  $\mu$ s”(100 kHz), “1  $\mu$ s” (1 MHz), “100 ns” (10 MHz), ‘50 ns’ (20 MHz), ‘25 ns’ (40 MHz), ‘12.5 ns’ (80 MHz), ‘6.25 ns’ (160 MHz), ‘3.125’ (320 MHz), and ‘1.56 ns’ (640 MHz).

For ‘sine’, ‘quad’, and ‘SSB Dual Sine’, the **Sample Rate** must be typically **Sample Rate**  $\geq$  8\***Frequency** for accurate signal generation.

*NOTE: For the “Pattern” type files the maximum sample rate is ‘25 ns’.*

Max Samples

1000

## Max Samples

Decimal notation input button that sets the number of samples in the emitted waveform. The maximum number of samples is 2000.

**Mode**run**Mode**

Drop down list button that enables and/or triggers a burst of an emitted waveform.

The 'run' value is used in global defaults or section defaults or within a test panel to initiate a waveform.

The 'stop' value is used in global defaults or section defaults or within a test panel to cease a waveform.

The 'pmStart' value is used to trigger a burst of the waveform with a precision start time designated by the user within a test panel using a pre-measure sequence grouping.

The 'pmStop' value is used to trigger the end of a waveform burst with a precision stop time designated by the user within a test panel using a post-measure sequence grouping.

The 'trigger' value is used to start a waveform burst with a pre-set start time of 0 and is terminated by the user within a test panel using a 'pmStop' in the post-measure sequence grouping.

*NOTE: 'pmStart' and 'pmStop' must be used together within a test panel for the desired result of syncing the waveform with an event or user start time.*

**Waveform File**none**Waveform File**

Drop down list button that selects a waveform from the preloaded user-defined waveforms on the instrument.



**PANEL: MODULATION****Filter**

A drop down list button that selects a digital filter type to be applied to the waveform. Built-in types include: “Raised Cosine”, “Gaussian”, “GMSK”, or a user-defined filter type provided by the **Filter File** button.

Filter

none

**Filter Bw**

A decimal notation input button that sets the ratio of the selected filter’s bandwidth with the symbol bandwidth.

Filter Bw

1.0

**Filter Taps**

Decimal notation input button that sets the total number of digital filter coefficients.

Filter Taps

0

**Mod Index**

A decimal notation input button that sets the ratio of the excursions of the modulated signal to the signal level of the unmodulated carrier in the time domain.

Mod Index

1.0

**Data Bits**

An integer value button that sets the number of data points per record.

Data Bits

100

**Data Rate**

An integer value button that sets the output data point rate in units of Hz

Data Rate

1000000

**Modulation Type**

A drop down list button that selects a modulation from the built-in standards: “Ran FSK” - Random Frequency Shift Keying, “8PSK” - 8

Modulation Type

none

Symbol Phase Shift Keying, “Edge”, “QPSK” Quadrature Phase Shift Keying, “FM Tone”, and “AM Tone”

Filter File

none

### Filter File

A drop down list button that selects the file name of a user-defined digital filter taps or coefficients file. The maximum number of coefficients is 200.

Prn Type

none

### Prn Type

A drop down list button that selects the size of the pseudo random number seed used in the sequence generator. i.e “PN5”, “PN7”, “PN9”, etc.

Data Delay

0

### Data Delay

A decimal notation input button that sets the data output delay in units of seconds with a resolution of 1  $\mu$ s.

## SINEGEN

### PANEL: STATE

Frequency Wf 8

1

### Frequency Wf 8

Decimal notation button that sets the output sine wave’s frequency in MHz. The range of values are 1kHz to 100MHz.

Amplitude Wf 8

0

### Amplitude Wf 8

Decimal notation input button that sets the amplitude of the open-circuit, peak-to-peak voltage of the in-phase (real) signal component. The signal is available at WF8 located at position C4 on the instrument head. Input value is peak-to-peak voltage (i.e - a value of 2 results in a +1V to -1V signal). Maximum value is 2.5 volts.

Offset Wf 8

0

### Offset Wf 8

Decimal notation button that sets the signal DC offset voltage for the waveform at WF8 located at position C4 on the instrument head.

*NOTE: The output waveform plus the offset cannot exceed  $\pm 3$  volts.*

### Frequency Wf 9

Decimal notation button that sets the output sine wave's frequency in MHz. The range of values are 1kHz to 100MHz.

Frequency Wf 9

1

### Amplitude Wf 9

Decimal notation input button that sets the amplitude of the open-circuit, peak-to-peak voltage of the quadrature (imaginary) signal component. The signal is available at WF9 located at position C8 on the instrument head. Input value is peak-to-peak voltage (i.e - a value of 2 results in a -1 V to +1 V signal). Maximum value is 2.5 volts.

Amplitude Wf 9

0

### Offset Wf 9

Decimal notation button that sets the signal DC offset voltage for the waveform at WF9 located at position C8 on the instrument head.

Offset Wf 9

0

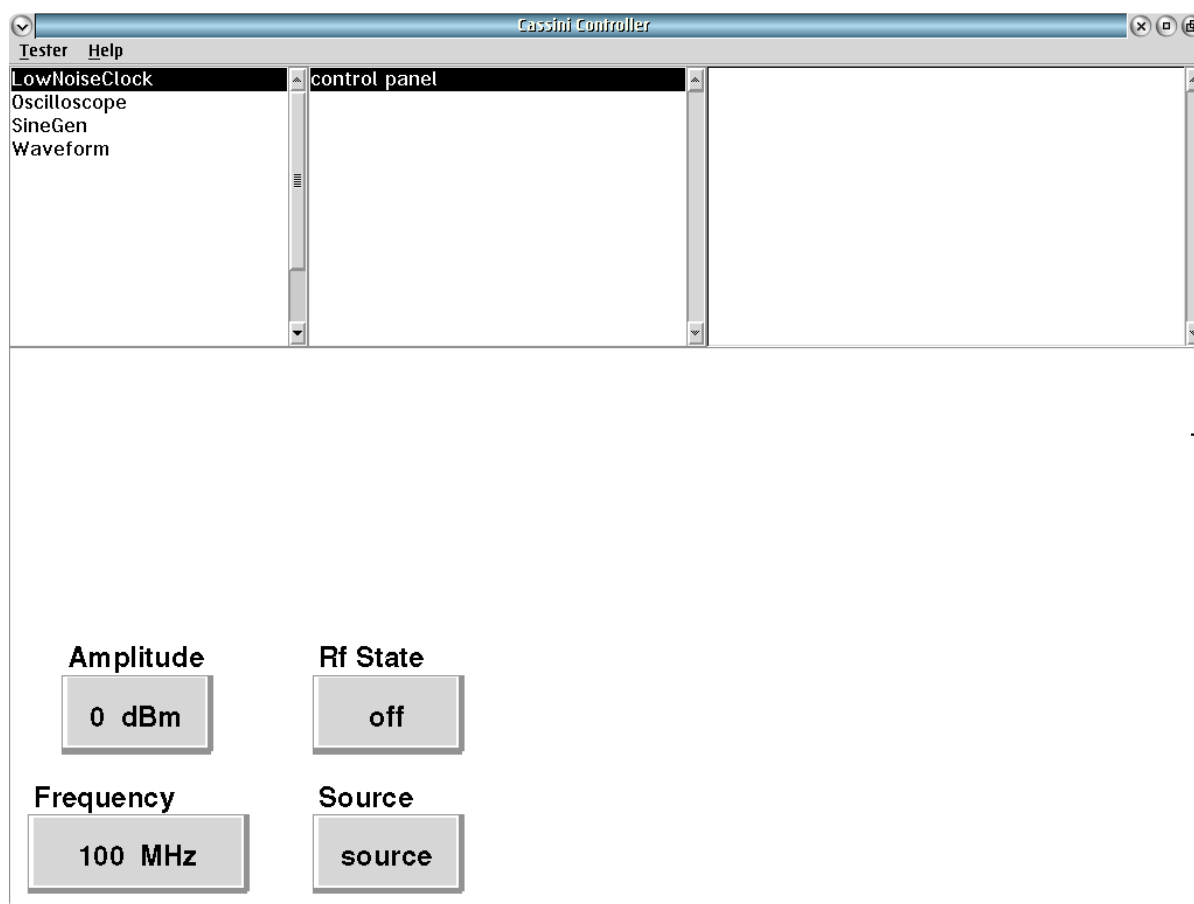
*NOTE: The output waveform plus the offset cannot exceed  $\pm 3$  volts.*

## CONTROL PANELS

Real time control of the instruments in this TIM.

See Control buttons.

### CONTROL PANELS 17 RI8594: HIGH PERF. WAVEFORM



## OSCILLOSCOPE

### SCOPE

### MEASURE, RMS DFT, Y PARAMETER, Y FORMAT, /DIV

Update the graph with measured values in real-time.

### COUNTER CONTROL

### Edge Period, COUNTER FREQ, COUNTER

Click to update measurement in real-time.

# RI8595: 700MHz TO 6GHz POWER AMPLIFIER



## TOPICS

---

[Instruments Provided by this TIM](#)

[Configuration Panel](#)

[Setup & Operation](#)

[Software Control](#)

Tap the links above to quickly access content

## INSTRUMENTS PROVIDED BY THIS TIM

The instrument is this TIM appears as **PowerAmp** in panel dialog windows.

Model and Name as it appears in the Tester Configuration:

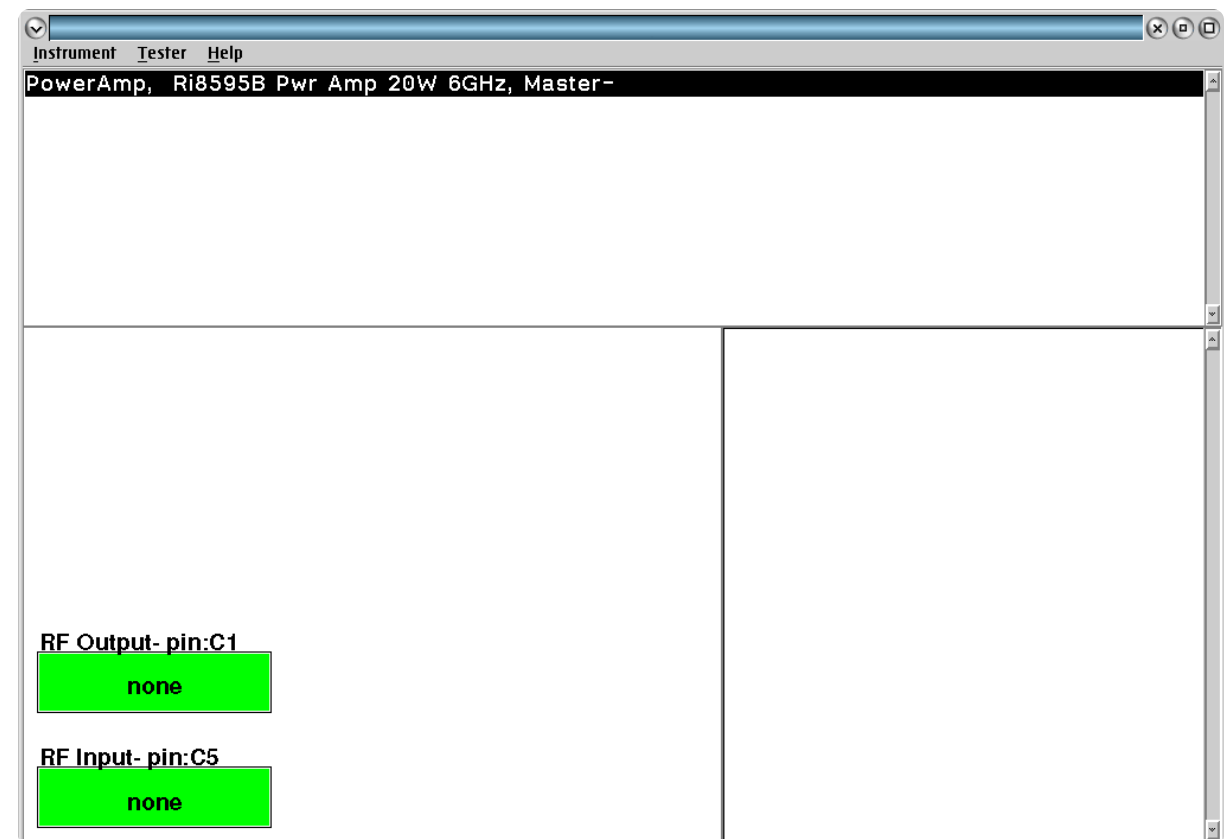
- PowerAmp, Ri8595B Pwr Amp 20W 6GHz

*NOTE: Multiple RI8595 instruments are enumerated incrementally by the system as "2", "3", etc. in configuration panels (i.e - PowerAmp, PowerAmp2, PowerAmp3, etc).*

## CONFIGURATION PANELS

The configuration panel displays the resource port mapping of the PowerAmp instrument. Reference the [Device Connection Editor](#) tutorial in Chapter 1 | Section 10 - Software: Environment & Tools for more information about resource port mapping.

### CONFIGURATION PANELS 7 RI8595: 700MHZ TO 6GHZ POWER AMPLIFIER



The input and output port connections to/from the Power Amplifier TIM (shown in green) must be defined by a fixture definition.



---

## SETUP & OPERATION

The RI8595 power amplifier is designed to operate as a constant gain amplifier for the RI8508 RF Source. The *RF Input (C1)* port of the RI8595 must be connected to either the *Output1 (C5)* or *Output2 (C1)* port of the RI8508 RF Source. The *RF Output (C5)* port of the RI8595 can be connected to standard RF interconnect within the fixture to either a DIB interface signal launch or bulkhead type connector.

---

**CAUTION:** *Exceeding the power amplifier's maximum allowable input signal will cause an over current condition in the TIM slot and the test system will deactivate the 48V supply to the TIM slot.*

*A system startup must be performed to recover the disabled slot.*

---

---

**WARNING:** **The output port must be connected to a load or termination, when an input signal is supplied to the power amplifier TIM. An output port VSWR condition of 4:1 or greater during operation will result in permanent damage to the internal circuitry of the power amplifier.**

---

---

## SOFTWARE CONTROL

The **PowerAmp** instrument has no graphical buttons in the Editor or Control panels; It functions as constant gain amplification for the RI8508 RF Source. A [Fixture Definition](#) with connections from the RI8508's output to the RI8595 input port and the signal path from the output port of the RI8595 through the fixture to the DIB interface is required to use this TIM. This allows the software to define a calibration path between the instruments that includes the signal loss through the cabling and the gain of the amplifier. The signal path definition allows the software to automatically adjust the RI8508's set power to achieve a user-specified signal power at the output of the amplifier/DIB interface using the RFSOURCE instrument **Power** button. The path definition also enables the software to automatically limit the maximum allowable power from the RF Source to not exceed the maximum input power ratings of the power amplifier.

*NOTE: This instrument requires software patch 287 (GF10RC2A.287).*

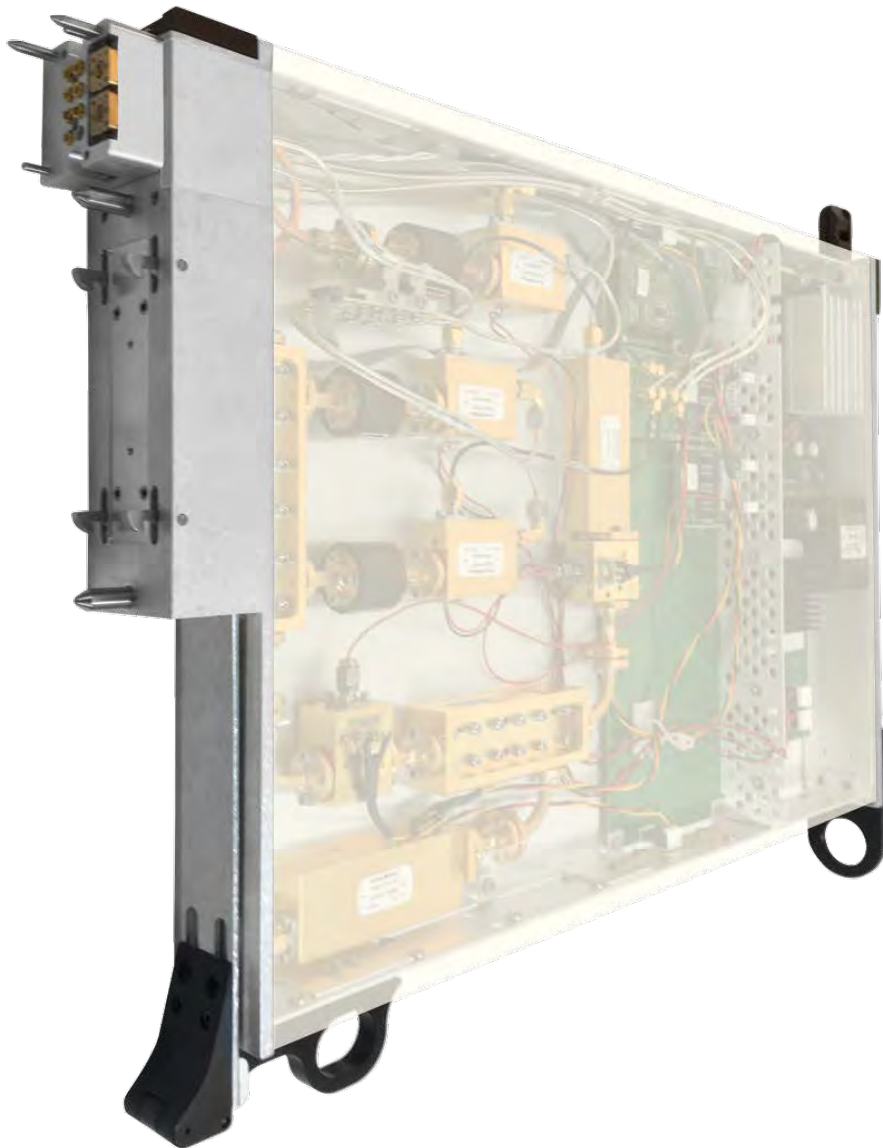
*View [Figure 1.56](#) and [Figure 1.57](#) for more information on software shortcuts, updates, and patches.*

---

**CAUTION:** *Without an active fixture definition (that includes an input port connection to the PowerAmp instrument) in the System Configuration, the input signal to the power amplifier can exceed the maximum allowable power causing the test system to deactivate the 48V supply to the TIM slot the RI8595 occupies.*

---

# RI8604: 71GHz TO 86GHz TESTSET



## TOPICS

---

[Instruments provided by this TIM](#)

[Instrument Diagram with Edit Buttons](#)

[Edit Panel Button Descriptions](#)

[Control Panel](#)

Tap the links above to quickly access content

## INSTRUMENTS PROVIDED BY THIS TIM

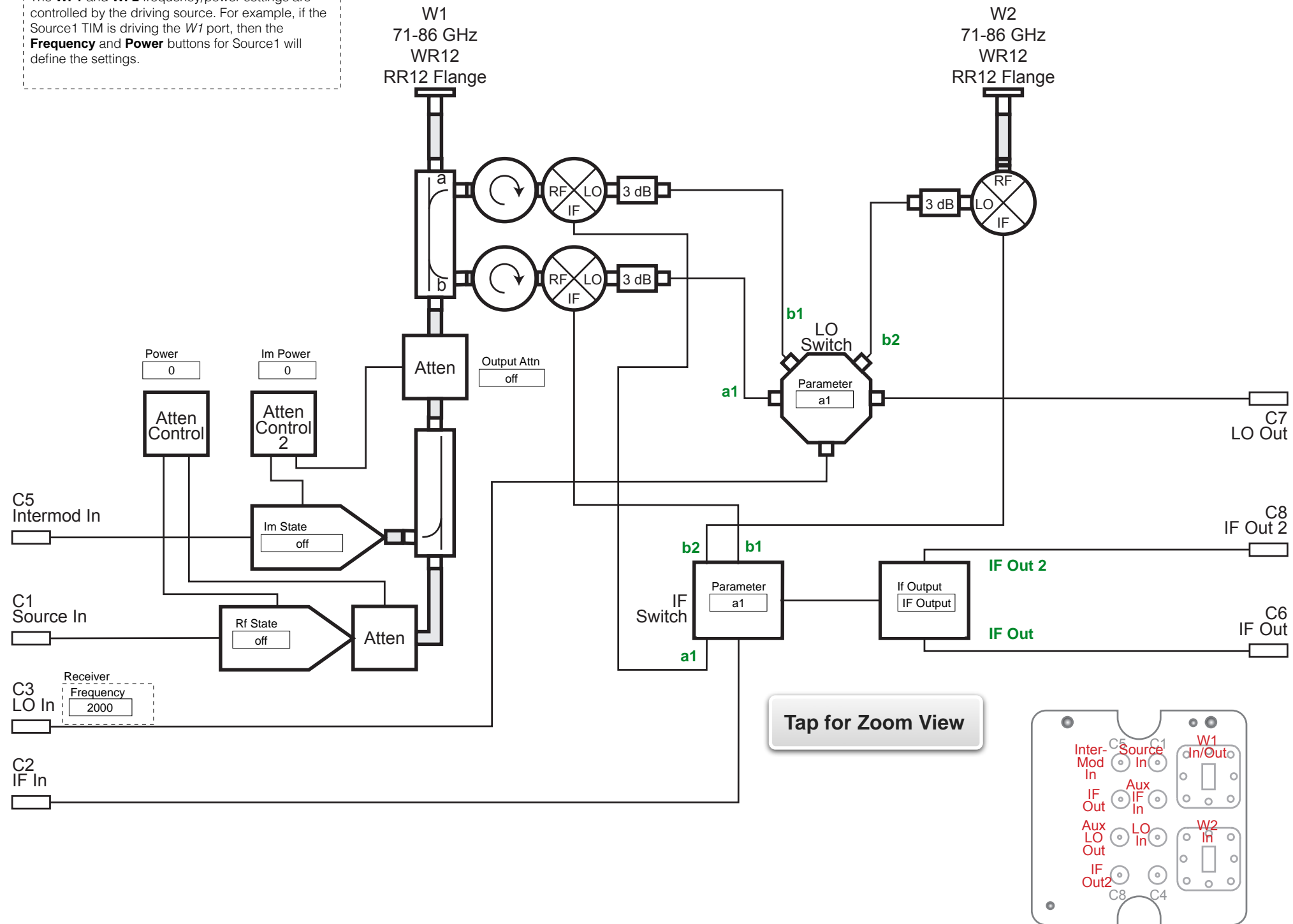
The instrument in this TIM appear as **Test Head77** in the panel dialog windows. Model and Name as it appears in the Tester Configuration:

- Test Head77, RI8604x 81 GHz Test Set

*NOTE: Multiple RI8604 instruments are enumerated incrementally by the system as “2”, “3”, etc. in the configuration, edit, and control panels (i.e - Test Head77, Test Head772, Test Head773, etc). The “x” in RI8604x denotes the model revision number.*

INSTRUMENT BUTTON DIAGRAM 2.14: RI8604A

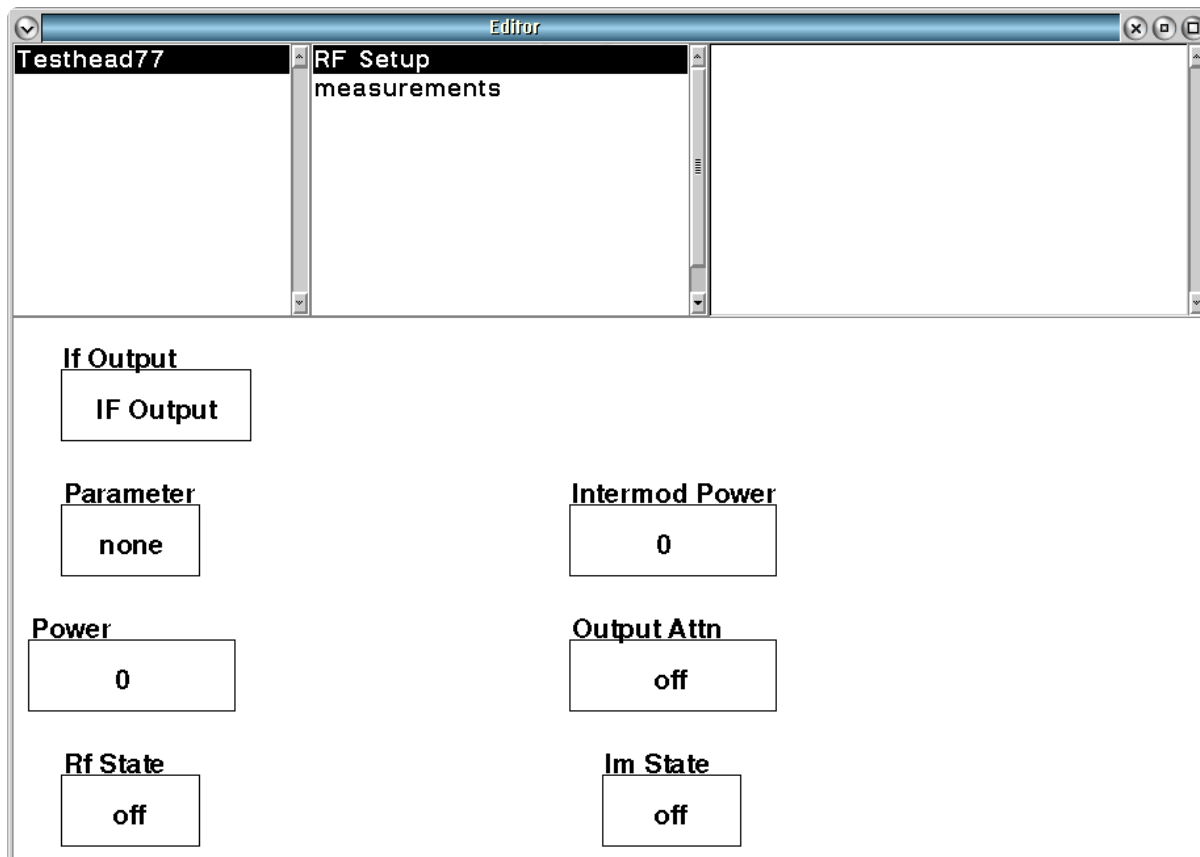
The **WF1** and **WF2** frequency/power settings are controlled by the driving source. For example, if the Source1 TIM is driving the *W1* port, then the **Frequency** and **Power** buttons for Source1 will define the settings.



## EDIT PANELS

Automated control of the instruments in this TIM with use by the Test Plan Editor.

### EDIT PANELS 23 RI8604: 71-86GHZ TEST SET



Testhead77 RF Setup panel provides instrument setup states.

## PANEL: RF SETUP

**The measure frequency of the RI8604 is set by the RI8581/RI8587 Receiver TIM's Frequency button in conjunction with a fixture definition defining a connection between one of the Receiver's IF In and LO Out ports and the RI8604's LO In [C3] and IF Out [C6] ports.**

Parameter

none

### Parameter

Drop down list button that designates a coupler port that will be routed to the IF switching network for measuring incident/reflected waves and/or computing s-parameters.

The 'none' selection disconnects all IF resources from the downstream receiver chain.

The 'a1' selection routes the down-converted IF signal from the incident signal (a<sub>1</sub> denoted as the 'a' port of the coupler in [Instrument Button Diagram 2.14](#)) of the W1 71-86GHz port to the downstream receiver chain.

The 'b1' selection routes the down-converted IF signal from the reflected signal (b<sub>1</sub> denoted as the 'b' port of the coupler in [Instrument Button Diagram 2.14](#)) of the W1 71-86GHz port to the downstream receiver chain.

The 'b2' selection routes the IF signal from the down-converted *W2 71-86GHz* port (*b2* signal ) to the downstream receiver chain.

**NOTE:**

*a<sub>1</sub>* is the incident wave to the input port of the device under test.

*b<sub>1</sub>* is the reflected wave from the input port of the device under test.

*b<sub>2</sub>* is the reflected wave from the output port of the device under test.

Power

0

**Power**

Decimal notation input button that controls the step attenuator in the *Drive In (C1)* path to set the signal power at the *W1 71-86GHz* output port. The valid input range is -90 to 5 (-90 dBm to +5 dBm) with a resolution of 0.1dB.

---

**The source frequency of the RI8604 is set by the Frequency button of the source connected to the Drive in (C1) input port in conjunction with a fixture definition with a connection between the source's output port and the RI8604's Drive In (C1) ports.**

---

Rf State

off

**Rf State**

A drop down list button that sets the state of the 8x frequency multiplier in the source path from the *Drive in (C1)* input port.

The 'on' selection connects the source path from the *Drive in (C1)* port to the microwave multiplier and out of the *W1 71-86GHz* output port.

The 'off' selection disconnects the *Drive In (C1)* port source from the 8x frequency multiplier chain.

If Output

If Output

**If Output**

A drop down list button that controls the IF Switch network for routing down-converted IF signals to the selected output port.

The 'IF Output' selection routes the down-converted IF signal to the *IF Out (C6)* port.

The 'IF Output 2' selection routes the down-converted IF signal to the *IF Out 2 (C8)* port.



**Intermod Power****Intermod Power**

Decimal notation input button that controls the step attenuator in the *Intermod In (C5)* path to set the signal power of the source supplying the intermodulation signal at the *W1 71-86GHz* output port. The valid input range is -90 to 5 (-90 dBm to +5 dBm) with a resolution of 0.1dB.

**Output Attn****Output Attn**

A drop down list button that controls a fixed attenuator step in the *W1 71-86GHz* output port path. It is used to extend the low-end dynamic range of the source connected to the *Drive In (C1)* for DUTs with high gain.

The 'off' selection sets the source path from the *Drive in (C1)* port into "pass through mode" to the microwave multiplier and out of the *W1 71-86GHz* output port.

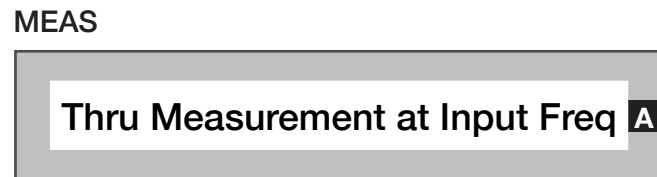
The 'off' selection disconnects the RF source from the multiplier chain.

**Im State****Im State**

A drop down list button that sets the state of the 8x frequency multiplier in the source path from the *Intermod In (C5)* input port.

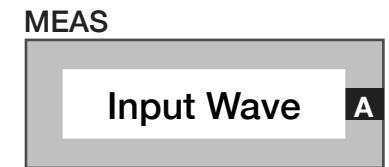
The 'on' selection connects the source path from the *Intermod In (C5)* port to the microwave multiplier and out of the *W1 71-86GHz* output port.

The 'off' selection disconnects the the *Intermod In (C5)* port source from the 8x frequency multiplier chain.

**PANEL: MEASUREMENTS****Meas: Thru Measurement at Input Freq**

Measurement block that computes the error correction factors for the signal path connecting the *W1 71-86GHz* port and *W2 71-86GHz* port to generate a 'perfect' thru reference from a non-perfect thru standard. The computed error correction factors emulate a perfect thru(lossless) with  $S_{11}$  and  $S_{22}$  terms equal to zero (negative infinity approximated by -180dB), and  $S_{21}$  and  $S_{12}$  equal to one (0dB).

*NOTE: This measurement block is typically used as a calibration method to create a perfect thru standard from a generic, non-perfect thru path for relative measurement comparisons.*

**Meas: Input Wave**

Measurement block that captures the incident and reflected waves as  $a_{11}$  (signal out of *W1 71-86GHz* output, measured on the 'a' port of the coupler in [Instrument Button Diagram 2.14](#)) and  $b_{11}$  (signal into *W1 71-86GHz* port, measured on the 'b' port of the coupler in [Instrument Button Diagram 2.14](#)). The output data type is two complex voltages for  $a_{11}$  and  $b_{11}$ .

**Meas: S11**

Measurement block which performs a series of  $a_1$  and  $b_1$  wave parameter measurements to calculate a vector error-corrected  $S_{11}$  ( $b_1 / a_1$ ) measurement. The output data type is a ratio expressed as a complex voltage.

Average Mode

std

## Average Mode

A drop down list button that sets the method of averaging used for s-parameter measurements. It is commonly used with the **S11, Thru Measure at Input Freq**, and **S Parameter** measurement blocks.

The 'std' (standard) mode measures and averages each individual wave parameter during an s-parameter measurement. The **Averages** button value (found in the **System > state** panel of the Editor) sets the number of samples for the average. For example, a test panel with an **S11** measurement block and **Averages** button value of '4', would measure  $a_1, a_1, a_1, a_1$ , then  $b_1, b_1, b_1, b_1$ .

*NOTE: The 'std' is the fastest averaging mode.*

The 'adjacent' mode interleaves the measure of wave parameters during an s-parameter measurement. The **Averages** button value (found in the **System > state** panel of the Editor) sets the number of samples for the average. For example, a test panel with an **S11** measurement block and **Averages** button value of '4', would capture the measurements as  $a_1, b_1, a_1, b_1, a_1, b_1, a_1, b_1$ .and then average the individual wave parameters. The 'adjacent' averaging mode is slower than the 'std' mode due to additional signal switching between wave captures, but can minimize memory, temperature and/or signal

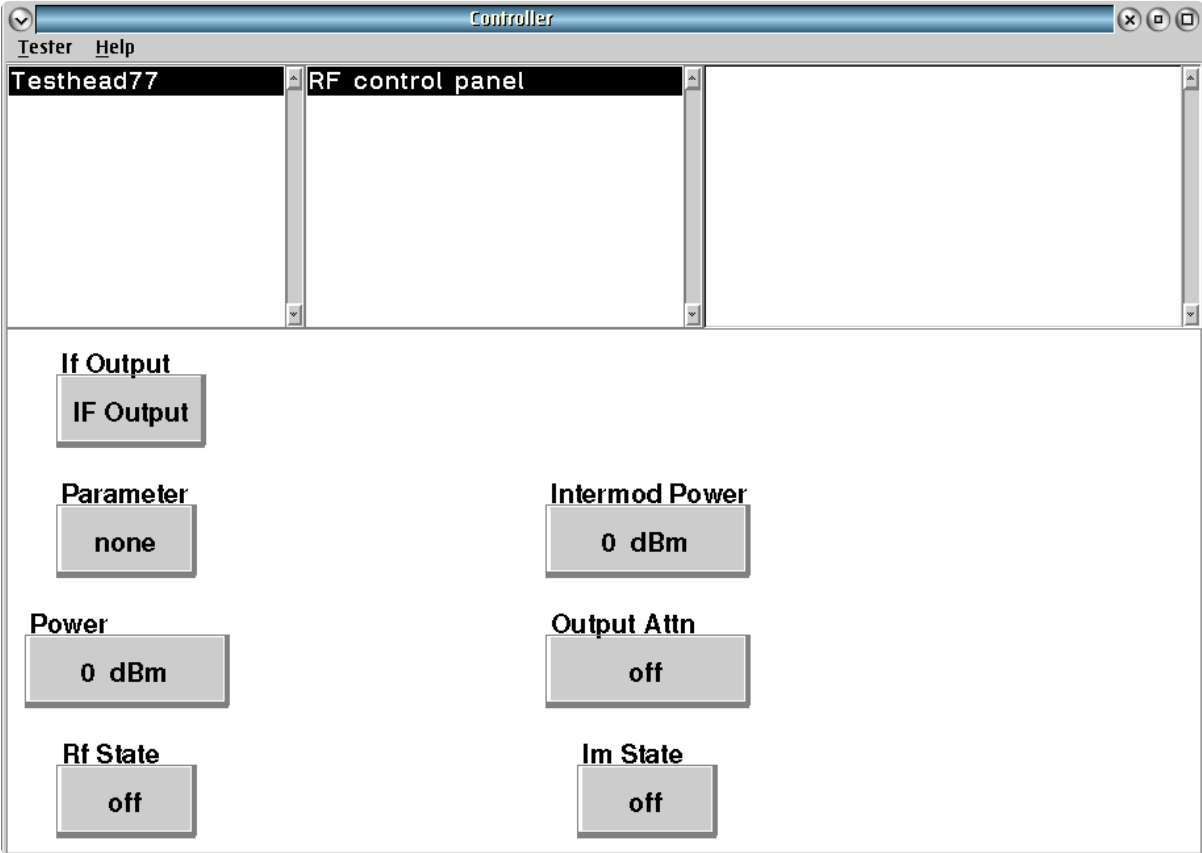
instability from the DUT during large measurement captures or averages.

*NOTE: At higher frequencies and with averages greater than 8 to 16, some improvement in accuracy and repeatability are often achieved using the adjacent averaging mode.*

# CONTROL PANELS

Real-time control of the instruments in this TIM.

## CONTROL PANELS 18 RI8604 71-86GHZ TEST SET



Testhead77 **RF control panel** provides real-time control of the instruments in this TIM.

# CARE & MAINTENANCE

---

# 3

Provides General Care & Maintenance Information for:

- ESD Control
- Maintenance Schedule
  - Daily
  - Periodic
- Fixture Care
- RF Connector Care

# ELECTROSTATIC DISCHARGE (ESD) CONTROL

Electrostatic Discharge (ESD) often damages or reduces the life of the test system or its components. The following steps should minimize ESD damage.

## CREATE AN ANTISTATIC WORK AREA BY:

- Spraying all surfaces (floors as well as tables) with an antistatic solution.
- Handling all electronic parts and assemblies in antistatic containers.
- Using static conductive floor mats and grounded antistatic service mats.
- Using grounded wrist straps (with 1-Megohm resistors).
- Discharge static from personnel before handling electronic components or printed circuit boards by using wrist ground straps and antistatic outer clothing.
- Discharge static from tools before they are used to service electronic assemblies.

- Service or work on electronic assemblies only in areas which are static-controlled.
- Remove the following materials from the test/work areas:
  - Food containers and wrappers (plastic, cellophane, paper and Styrofoam)
  - Clothing and shoes fabricated from man-made materials (rubber-soled shoes)
  - Paper
  - Tapes
- Maintain humidity levels between 40 and 60%.
- In severe static-inducing conditions, for example in automated work areas or where the humidity levels are very low, use air ionizers.
- Consult an ESD Control Specialist for additional recommendations.



# MAINTENANCE SCHEDULE

Cassini test systems are designed for high-volume use in a production environment. If properly maintained, the test system should only require a minimum amount of scheduled downtime to maintain performance. The provided maintenance schedule summary is a recommended guideline based on the requirements of a standard, high-volume production test floor. The planned maintenance timelines can be extended when used in a lab setting, very low volume production, or a thermally stable ( $\pm 5^{\circ}\text{C}$ ) and "Class 3+ Cleanroom" test floor. The frequency and details of the procedures listed in the Preventive Maintenance Schedule can be adapted by the end-user's discretion. For example, calibrations can be safely postponed up to 6 months time if the system is in a thermally stable environment where the ambient temperature does not vary by more than  $5^{\circ}\text{C}$ .

**\*As Needed:** Maintenance should be completed either within the recommended time period or as needed; whichever occurs first.

**\*\*Required Tools:** Standard Tools include Clean Dry Air (CDA) or Pressurized Air, Cotton Swabs, Tweezers, Alcohol and SMA torque wrench. Diagnostic/Calibration Plate is provided with the system. Full

Calibration Kit is either contained onsite or provided by RI during a scheduled visit.

**PREVENTIVE MAINTENANCE SCHEDULE**

Maintenance	Daily	Monthly	Quarterly	Yearly	*As Needed
Socket	✓				MFG Suggestion
DIB		✓			>10% Yield Change
Test Head TIM Ports	✓				1000 Fixture Docks
Fixture Inserts at DIB	✓				1000 DIB Installs
Docking Hardware		✓			1000 Docks
Handler Pod - Test Head RIFL Cable			✓		Frequent Handler Changes
Diagnose/ Verify		✓			Yield Drops
TIM System Calibration				✓	TIM Swap
Auxiliary Rack RF Cables			✓		TIM Swap
Fixture Calibrations	Never Calibrate Fixture Unless Modified				Modification/ Damage

**PREVENTIVE MAINTENANCE DETAILS**

<b>Mainten ance</b>	<b>Time to Complete</b>	<b>Role/ Login</b>	<b>**Required Tools</b>	<b>Notify RI Support</b>
Socket	1-2 min	Operator	Standard Tools	
DIB	10 min	Maintena nce	Standard Tools. Voltmeter, Magnifier	
Test Head TIM Ports	2 min	Operator	Standard Tools	
Fixture Inserts at DIB	1 min	Operator	Standard Tools	
Docking Hardware	30 sec	Operator		If wear is found
Handler Pod - Test Head RIFL Cable	1 min	Operator		
Diagnose/ Verify	1-5 min (selective) 1 hour (complete)	Maintena nce	Diagnostic/ Calibration Plate, Power Meter	✓

# DAILY MAINTENANCE

Daily maintenance typically includes the cleaning and repairing of sensitive electronic connectors. Isopropyl alcohol (at least 90% concentration) is the Roos Instrument's approved solvent to clean connectors. Connector and component surfaces should be dried using de-ionized, compressed air to remove residual debris. If the contamination is not removed, test operations should cease and affected components should be shutdown and removed for maintenance. If the severity of the contamination or damage to a component is such that it cannot be repaired onsite, contact Roos Instruments for repair and/or service support.

## DAILY MAINTENANCE PROCEDURE

Carefully inspect socket and load board connections. Look for any physical damage, bent pins or fingers, and contamination such as dirt, dust, or metal flakes.

Check microwave and DC connectors between the fixture and test head for signs of wear or damage. Look for any physical damage, bent pins or fingers, and contamination such as dirt, dust, or metal flakes.

---

*CAUTION: Small pieces of metal or conductive debris can cause an electrical short between components or to ground resulting in damage to the test system components.*

---

- Inspect the docking hardware for signs of mechanical wear.

---

**WARNING: Worn components can cause improper alignment resulting in intermittent measurements.**

---

- Inspect RIFL cables attached to Handler Pods for signs of any damage or loose connections.
- Verify that the grounding wire and alligator clips between the handler and test system and/or auxiliary rack and test system are properly attached to an electrically grounded metal on both ends. Alligator clips are provided as a convenience and can be changed to a more permanent solution with spade clips.
- If there is physical damage to any of these components or cables, the system should be serviced immediately. If the components cannot be repaired onsite, contact Roos Instruments for repair and/or service support.

# PERIODIC MAINTENANCE

- Visually inspect all connectors between the test head and fixture. Look for any signs of physical damage: bent pins or fingers in the PKZ #12 connector, and contamination such as dirt, metal flakes, etc.
- Check the physical interface between the fixture and handler for signs of wear or damage.
- Connect the Calibration/Diagnostic plate to the test head.

*NOTE: For proper alignment, the RI Logo Arrow should point towards the infrastructure chassis.*

## PERFORM FULL SYSTEM DIAGNOSTICS:

- From the Cassini window, choose **System > Tester** to open the Configuration Window.
- From the Configuration window, choose **Tester > Diagnose**. If multiple TIM configurations exist, choose the appropriate

name from the list that matches the current arrangement of TIMs and press **Select**.

- Choose **Run > All** to perform a full system check.
- Follow any on-screen instructions, making sure connectors are properly seated in the diagnostic fixture. This will verify that the system meets calibrated performance specifications.
- If there are any failures, follow the [Diagnose Procedure](#), document the failure, and request service from Roos Instruments support.

# FIXTURE CARE AND MAINTENANCE

## FIXTURE STORAGE

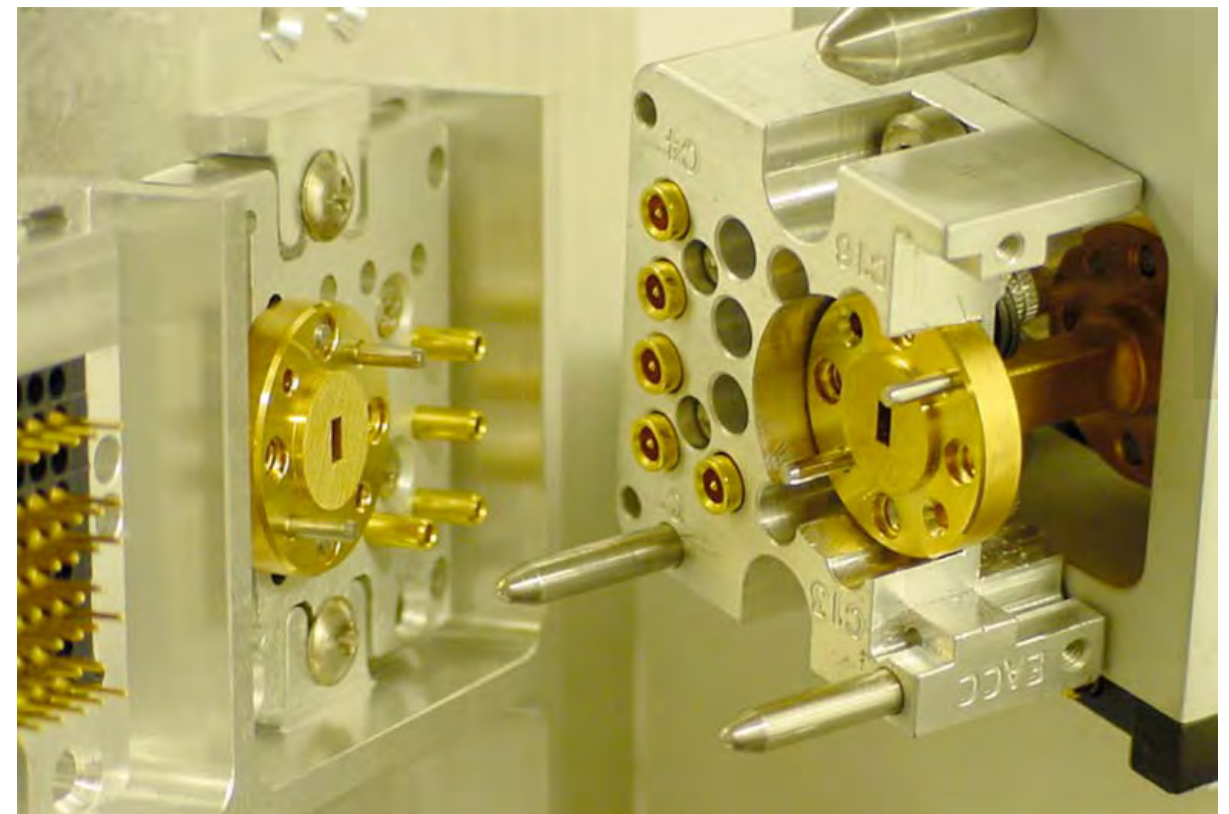
RF Fixtures use robust mechanical and electrical connections to survive the rigors of high volume semiconductor production. Regular repeated use without proper maintenance, however, can reduce the functional lifetime of the fixture.

Store the fixture in a protected place when not in use such as a metal cabinet or book shelf. Make sure that the shelf the fixture sits on is clean. The fixture feet will allow the fixture to sit without damaging the connectors. Check DC and RF connections periodically to ensure good contact and that damage has not occurred. Don't store the fixture in such a way as to allow objects to contact the bottom surface. Anti-static Styrofoam is OK. Doing otherwise may contribute to pin breakage or RF connector damage. Do not store on wire shelf racks.

## FIXTURE CLEANING

The Cassini family of testers use a combination of blind mate adapters between the test head and fixture that include: gold pins for DC, PKZ #12 connectors for the RF and waveguide for mmWave. These connectors can become contaminated and will need to be cleaned. PKZ #12 connectors have especially small physical dimensions needed for good RF performance, and therefore are very delicate.

FIGURE 3.1 TESTHEAD-TO-FIXTURE INTERFACE



Gold pins in fixture connector block shown on left, PKZ male and waveguide shown on center fixture block, and the mating TIM Waveguide block with female PKZ shown on right.



**CAUTION:** Standard cleaning methods, such as a cotton swab, can damage the PKZ #12 connector.

This document shows how to clean PKZ #12 connectors using spray cleaner and spray duster. This technique works for both the male and female connectors.

To clean the connector, use a static-safe chemical cleaner such as TF-Cleaner shown in [Figure 3.2](#). If TF-Cleaner is not available, use an

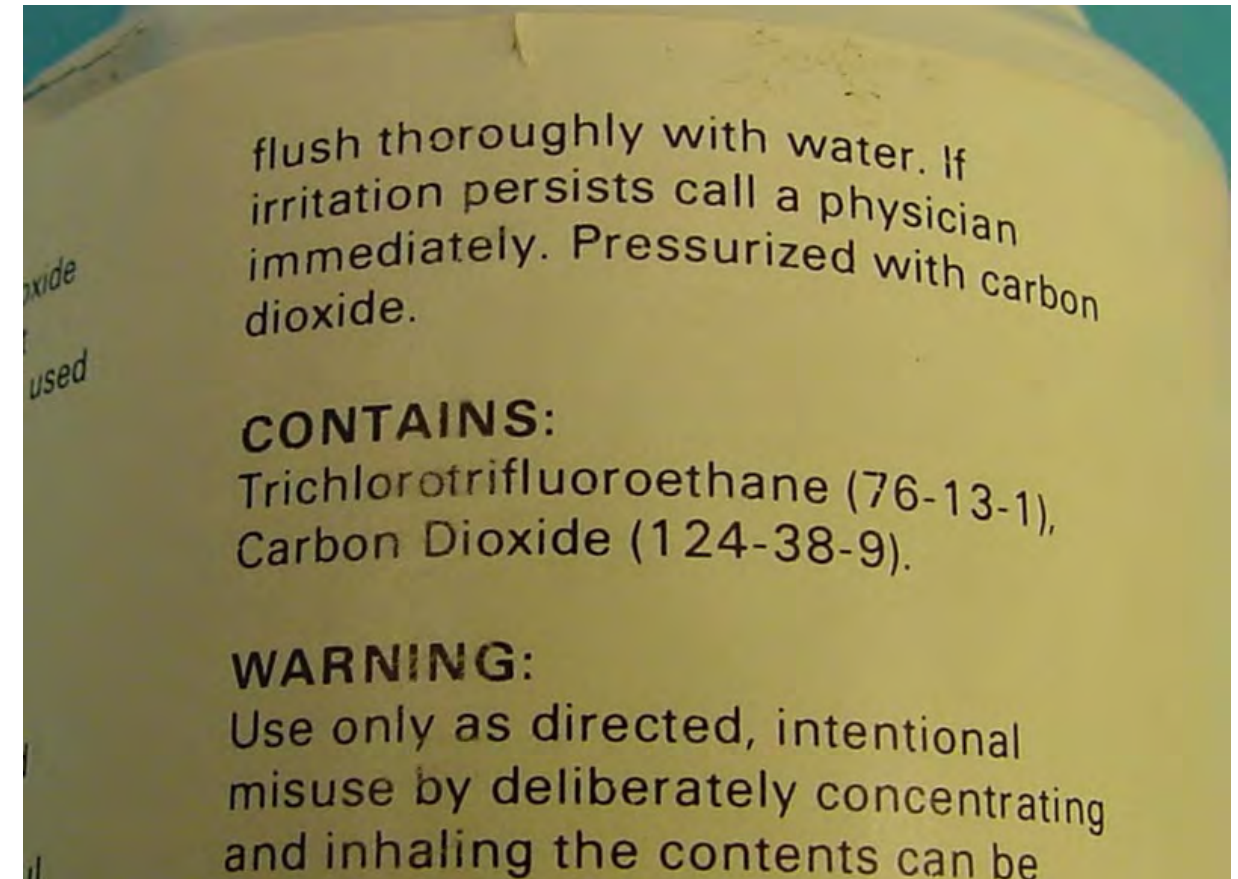
FIGURE 3.2 EXAMPLE CLEANER



Recommended solution for cleaning connectors

© Roos Instruments Inc.

FIGURE 3.3 CLEANER INGREDIENTS



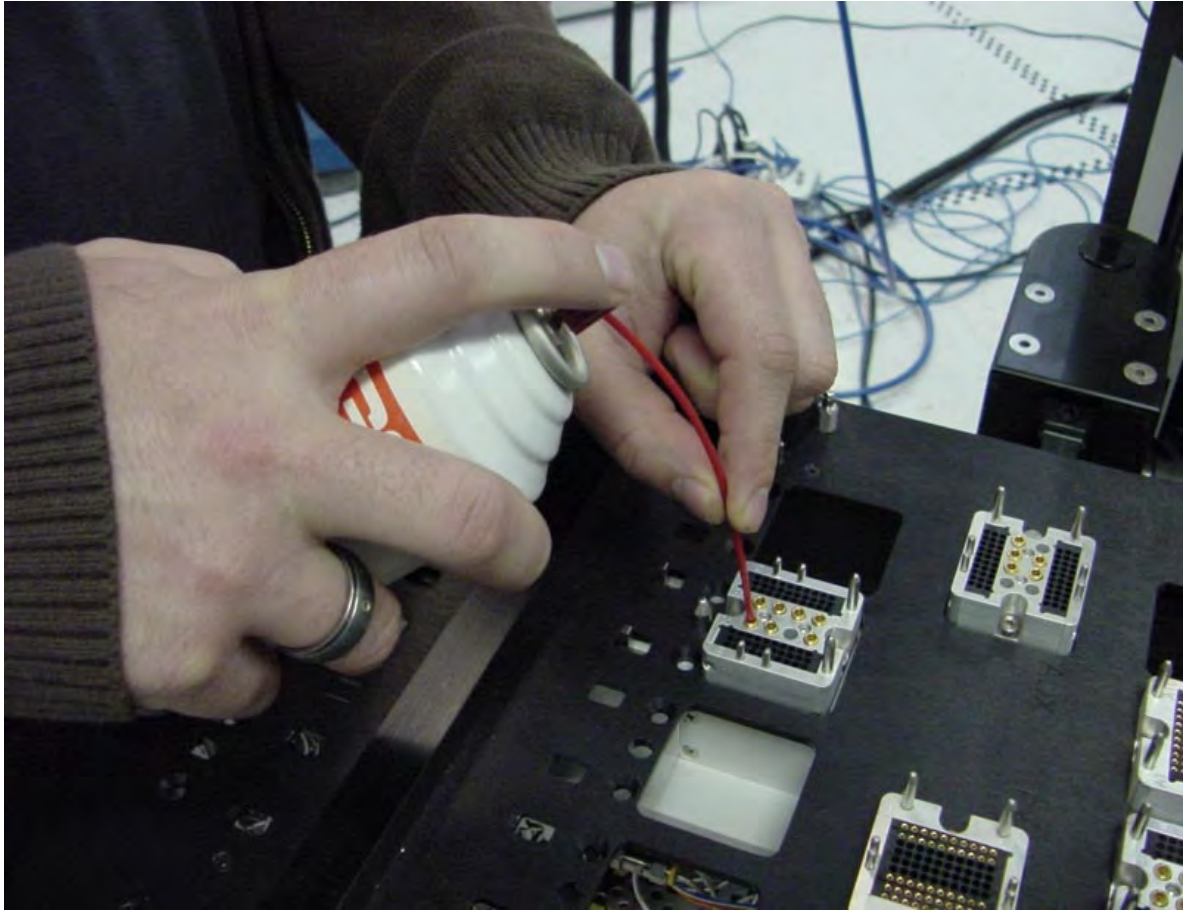
#### Ingredients for the TF Cleaner used by Roos Instruments

equivalent cleaner. Alcohol-based cleaners can also be acceptable, however cleaners that contain oils such as tuner cleaner, are NOT acceptable.

Using this, or an equivalent cleaner, spray a small amount into the connector as shown in [Figure 3.4](#). This should flush out any debris or contaminants.

**CAUTION:** Adhere to all safety use and warning labels on the cleaning solution container.

FIGURE 3.4 CLEANING THE CONNECTORS



Spray a small amount of cleaner into each connector as shown in the figure.

FIGURE 3.5 DIRTY PKZ #12 CONNECTOR EXAMPLE



Magnified view of contamination possibly shorting the center conductor to the outer shell

FIGURE 3.6 CLEAN PKZ #12 CONNECTOR EXAMPLE



Magnified view of a clean connector



After flushing the connector with cleaner, use a 'duster', such as shown in [Figure 3.7](#) to dry the connector. Clean, dry air or stable gas such as CO<sub>2</sub> are acceptable. Spray the duster into the connector to thoroughly flush any cleaner and dry the connector.

FIGURE 3.7 AIR DUSTER



Type of compressed air duster used at Roos Instruments

## DIB CLEANING

1. Using isopropyl alcohol (strength at least 98%) and a low-lint Q-tip or optical grade cleaning wipe, clean the contact side of the RF and DC interfaces carefully. Also wipe the tips of the pogo pins themselves.
2. Repeat step 1 for the contact pads of the socket.
3. Use compressed air to remove any residual alcohol or lint fibers.

## SOCKET CLEANING

1. Inspect the socket for any broken or misaligned contacts.
2. Replace bad contacts using the manufacturers prescribed replacement procedures.
3. Use a mild stream of air and/or a soft artists brush to remove loose debris from the socket when needed.
4. Follow the manufacturers prescribed cleaning process for debris that is not easily removed.

# RF CONNECTOR CARE

## HANDLING SMA CABLES

When working with RF SMA cables, use the proper technique when adding or removing connections (See [Figure 3.8](#)). The key to safely connecting any coax connector is to remember that the center conductor should not spin. The center conductors usually have a thin gold plate on them, and if the connector is spun excessively the gold plating can be damaged. The damaged plating would then oxidize and cause degraded RF performance and by extension repeatability and calibration issues. Some key rules for working with SMA type connectors on Cassini test systems are:

- Always turn the coupling nut, do not spin the center conductor.
- Do not twist or bend RF cables.
- Do not put a wrench on the gold trim cap on the Auxiliary rack RF cables (see [Figure 3.9](#)).
- Always use a 5/16 inch(8mm) SMA torque wrench set to 7–10 in·lb (0.8 to 1.1 N·m).

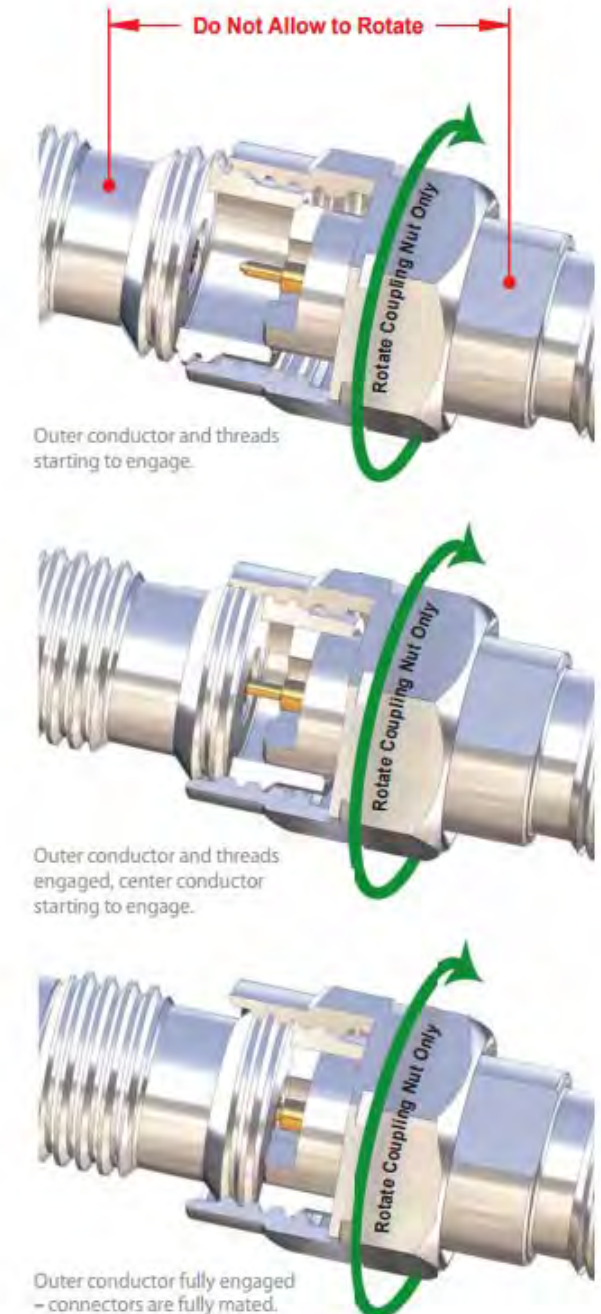
FIGURE 3.8 MATING MICROWAVE CONNECTORS

### Proper Procedure for Mating Microwave Connectors



1. Engage the two mating interfaces with slight pressure.
2. Hold the body of the male connector and **turn only the coupling nut**.
  - The coupling nut will engage the threads of the female connector.
3. Continue **turning only the coupling nut**.
  - The outer conductors will engage and align the connectors to each other.
  - Then the center conductors will engage.
  - Then the outer conductors (reference planes) will come together and the coupling nut will quit turning.
4. Use a torque wrench to apply the proper torque to complete the mating.

When the proper procedure for mating microwave connectors is followed, no rotational torque is applied to the center conductors. If the body of either connector is rotated, this is improper and can apply a rotational torque to the center conductor. All Southwest Microwave connectors have the center conductor rigidly captured to the outer housing. The center conductor captivation is, in most cases, accomplished with a high temperature plastic bead. This bead provides high axial retention at extended temperatures, but does not provide for any rotational resistance. Therefore proper mating is strongly recommended.



### Procedure for mating microwave connectors



FIGURE 3.9 AUXILIARY RACK GOLD CAP



Do not use a wrench on gold trim cap.

# SERVICE

---



Contains General Service Information for:

- Exchanging New or Repaired TIMs
- Guru Network Setup
- RF Relay & Attenuator Wear Levels
- Getting Assistance from Roos Instruments



# EXCHANGING A NEW OR REPAIRED TIM

This section describes how to add a new, temporary replacement, or repaired Test Instrument Module. These instructions are the factory-specified guidelines for any new, factory-serviced, or factory-upgraded TIM to insure proper software and firmware compatibility.

## BEFORE THE TIM IS INSERTED INTO THE TEST SYSTEM:

A Guru zip file (.gzp) containing instrument definitions, software drivers, and calibration data must be installed in the test system's local or networked Guru. This file is provided by a Roos Instruments support engineer and must be imported before installing the TIM.

## IMPORTING SOFTWARE RESOURCES:

1. [Open the Guru Browser application](#) from the **Apps** button on the Guru control bar.
2. Import the definitions from the .gzp file into Guru using the [Import function](#) of the Guru browser. If the definitions in the .gzp were installed by a networked Cassini or simulator, the resources will sync to the test system's local Guru automatically when requested.
3. Remove the failed TIM if it is still installed. (See [Removing a TIM](#))
4. Once the software resources are installed, insert the TIM into the appropriate test head slot. (See [Installing a TIM](#))
5. Choose **System > Check** from the Cassini main system window.

*NOTE: The TIM's information and calibration data is automatically loaded from Guru when the instrument is powered up. As such, calibration of the TIM is not necessary.*

*If a testset TIM (RI8545, RI8563, RI8564, RI8567, RI8580) has been replaced or re-calibrated, then a full system calibration of RF TIMs connected to the testset/s may be required.*

6. Verify that the TIM has been added to system's configuration by checking the Equipment Pool or Configuration Window.

7. Verify that the TIM has valid calibration data by RMB clicking the TIM's instrument or instruments in the Configuration Window and selecting **Calibration > Inspect** menu. If the cal data values are all zero, then the Calibration data has NOT been loaded properly.

If the TIM installation is intended to be permanent and did not replace an existing TIM with the same model and location, the new tester definition should be saved. (See [Saving the Tester's Configuration](#))

Also, the test system's calibration list may have to be modified to include calibrations for the new TIM.

If a duplicate TIM is being added to the test system, the software will automatically assign the instrument name and the TIM instruments a number enumeration to the end of the instrument's name in the Equipment Pool and Configuration Window. For example, if a second RI8546C is added, containing the DutControl, PowerVI, and StaticDigital instruments, the new instruments will be assigned as DutControl2, PowerVI2, and StaticDigital2.

AUX Rack sources may require renaming to match the configuration as wired. Rename a TIM by selecting it from the Configuration window, RMB click and select **Rename**. Since two instruments can't be named the same, select a temporary name and continue renaming until all the Sources are named properly. A RecLO instrument must always be renamed manually.

If the TIM locations change, be sure to relocate or add the appropriate calibration block and/or interconnect cables to the Diagnostic/Calibration Interface plate. Also use the [Change the Calibration List](#) to set the default list of service test plans used to Diagnose or Calibration the system.

*NOTE: The Calibration List guru object is created at the Factory and affects both Diagnostics and Calibration. Contact [support@roos.com](mailto:support@roos.com) to coordinate any TIM reconfiguration.*

## SAVING THE TESTER'S CONFIGURATION:

1. Open the Configuration Window by choosing **System > Tester** from the Cassini main system window.
2. If one or more TIMs were added or removed, the default Calibration List must also be changed. Follow the [Change the Calibration List](#) procedure.
3. From the menu options along the top of the window, select **Tester > Save.**

*NOTE: The saved tester definition controls two main functions:*

1. *When multiple TIMs of the same type exist in the configuration, the definition sets the enumeration of the TIMs and the instruments within i.e. - defines which is instrument1 and which is instrument2, etc. as well as their corresponding location on the test head.*
2. *It enables simulated testers to use the same TIM and instrument layout configuration.*

It is important that the tester definition be saved after this type of installation. If the tester image is closed and re-started, the test system will need the updated tester definition to correctly and consistently identify the enumeration value of duplicate TIMs in the configuration.

# GURU NETWORKING SETUP (TCP/IP AND FTP)

## NETWORK SETTINGS

The network settings are managed by the embedded operating system (eCS). For Guru to operate properly, the network must be properly configured. The system controller is pre-configured to use DHCP to automatically assign appropriate network settings. If the network has a dedicated Guru Server, use the Guru Address Book to configure the connection to that server.

*NOTE: Before contacting RI Support for assistance in setting up Guru networking, have the following information available: IP address, TCP/IP Net mask, Default Route, and DNS Server or static host names.*

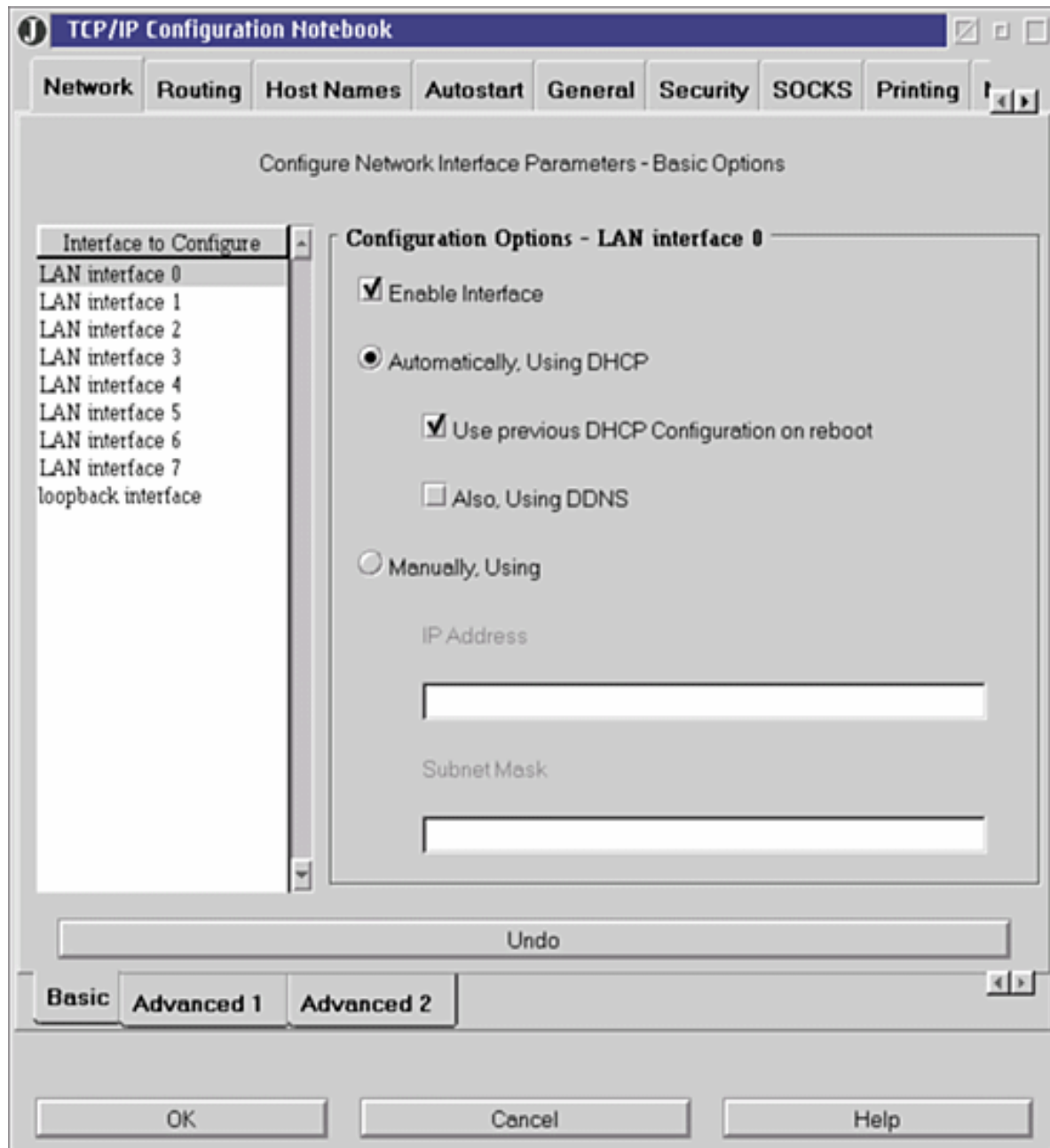
View the current IP address by entering **ifconfig lan0** into a command window prompt.

## TCP/IP CONFIGURATION

If the system controller needs to use a static IP address, follow the instructions below:

1. Access the TCP/IP Configuration workbook from the **System Configuration toolbox > Network > TCP/IP > TCP/IP Configuration**. ([Figure 4.1](#))
2. From the Network tab, change to **Manually, Using** and enter the IP Address and Subnet mask.
3. From the Routing tab, click **Add** button and enter the Router address change type to **default** and press **OK**.
4. On Host Names tab, enter the system controller's Host Name and click **Add** to add DNS server IP address.
5. If the Guru Server's host name is not properly resolved by DNS, enter it into the Hosts tab (along the bottom). Test this by typing **host <Guru hostname>** into a command window. If the result fails, then a Host Name is required.

FIGURE 4.1 TCP/IP CONFIGURATION NOTEBOOK, NETWORK



IP Address, Netmask setup screen.

## FTP CAPABILITY

- Use the FTP applications provided by eCS (GUI or CLI) to FTP out from the system
- FTP Daemon must be set to Autostart to accept FTP connections
- TCP/IP Security must be set for at least 1 user
- User must have a Password (min 5 characters)
- Available drives or files for FTP need to be set (use Negative logic to share all files and drives)
- Must have FTP enabled

## BINARY FTP TRANSFER MODE

This FTP capability is primarily for administrative activities. The preferred way to transfer test data is with the Guru Agent.

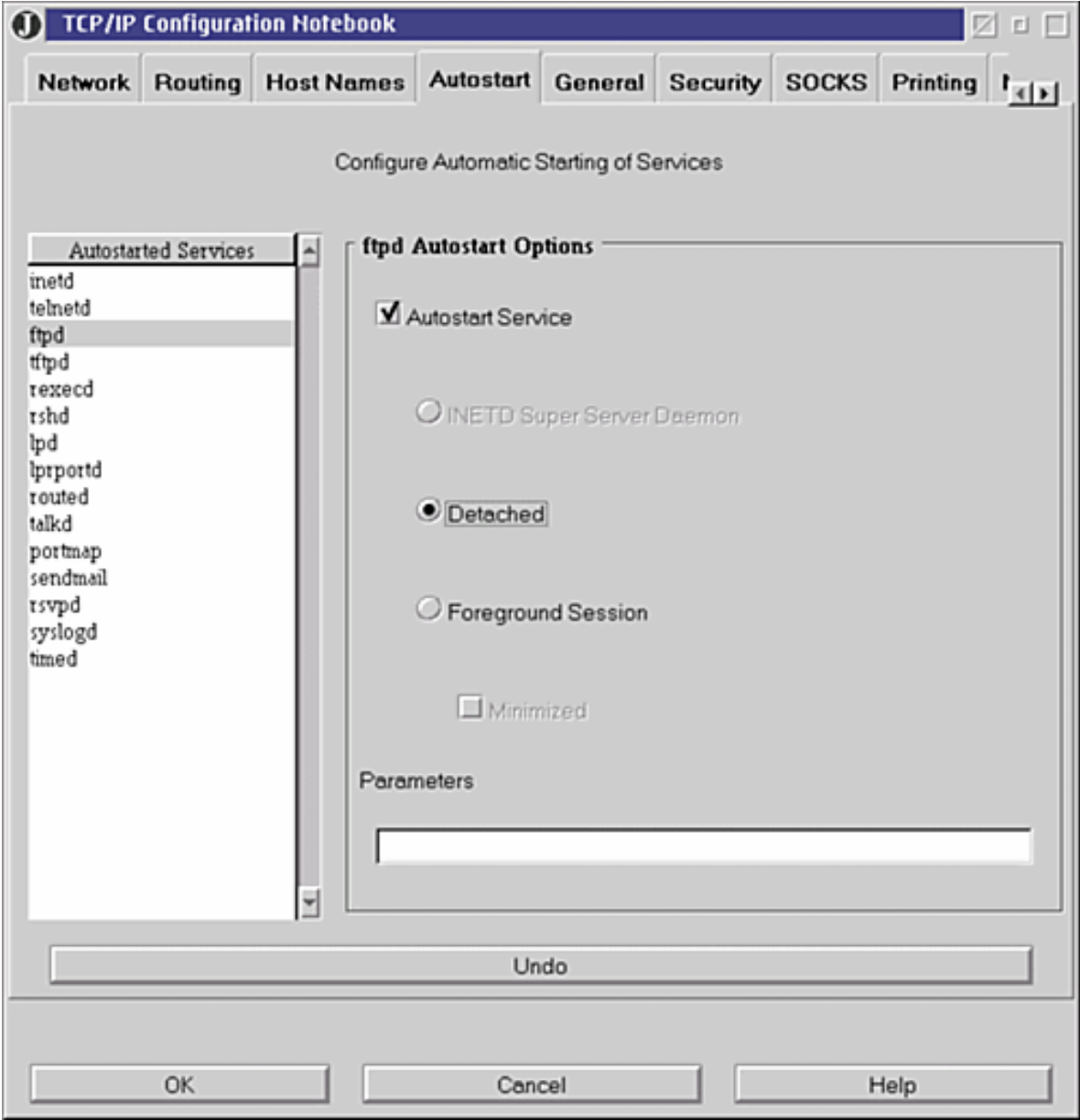
---

**WARNING: Always use binary mode when transferring files via FTP.**

---

ASCII mode will corrupt .gzip (and .zip) files because of the line feed conversion (ln -> ln+rf). To put the standard FTP client into binary mode, always enter the command **binary** before starting the file transfer.

FIGURE 4.2 FTP SERVER WITH TCP/IP



Servers setup screen enabling the FTP Daemon to run in the background and handle FTP requests.



# CHECKING WEAR LEVELS OF RF RELAYS AND ATTENUATORS

## WEAR LEVELS

Some TIMs contain mechanical RF relays and step attenuators that have a finite mechanical switching life cycle. The available life is based on the manufacturer's specified lifetime for each component (typically 10 million switches). As each component has a particular life expectancy, the software tracks and logs this information throughout TIMs duration in the system.

The wear levels are displayed in the [Messages Window](#) upon startup as shown in [Figure 4.3](#). When the wear level of a particular component reaches 70% of available life, a preventive maintenance and calibration procedure should be scheduled. When the wear level reaches 95% of available life the performance of the component can begin to degrade. The TIM containing the relay or step attenuator should be returned to Roos Instruments for servicing.

*NOTE: Switches or relays above 95% wear levels can degrade in performance causing poor impedance match conditions, signal leakage, power loss, and/or unresponsive switch control.*

FIGURE 4.3 SWITCH WEAR LEVELS



Switch wear levels are displayed in the Messages Window. To display the messages window select the **System > Messages** buttons from the main window.

# RESTORE, SYNC & LOG SYSTEM CONTROLLER

Guru provides tools to perform some administration tasks in the System window. A user must log in to Guru and have administration rights prior to performing any of the administration tasks.

Once logged in to Guru successfully, the Logon button changes to System button. Click the System button to bring up the System window.

Click the **Logoff** button to log out of Guru. You must log out of Guru to log in as a different user.

Click the **Shutdown** button to shutdown the Guru. Guru will restart automatically.

Click the **Restore** button to restore local Guru. This restores local Guru objects from a backup Guru. This feature will only work if the user has an Update Guru Server properly configured with the Guru Address Book application.

Click the **Synchronize** button to synchronize Local and Update Gurus. This feature checks the Local and Update Gurus and updates all objects on the Local Guru with the latest version from Update

Guru. This feature will only work if the user has a Guru Server properly configured.

*NOTE: The Guru objects automatically sync every time it is loaded. This button is helpful for speeding up this process after the system has been disconnected for a very long time.*

Click the **Message** button to see messages between Guru and Guru based applications. This is useful for debugging purposes. When the user clicks this button, a Logged Events Window will be displayed.

Click the **Cancel** button to dismiss the System window.

## LOGGED EVENTS WINDOW

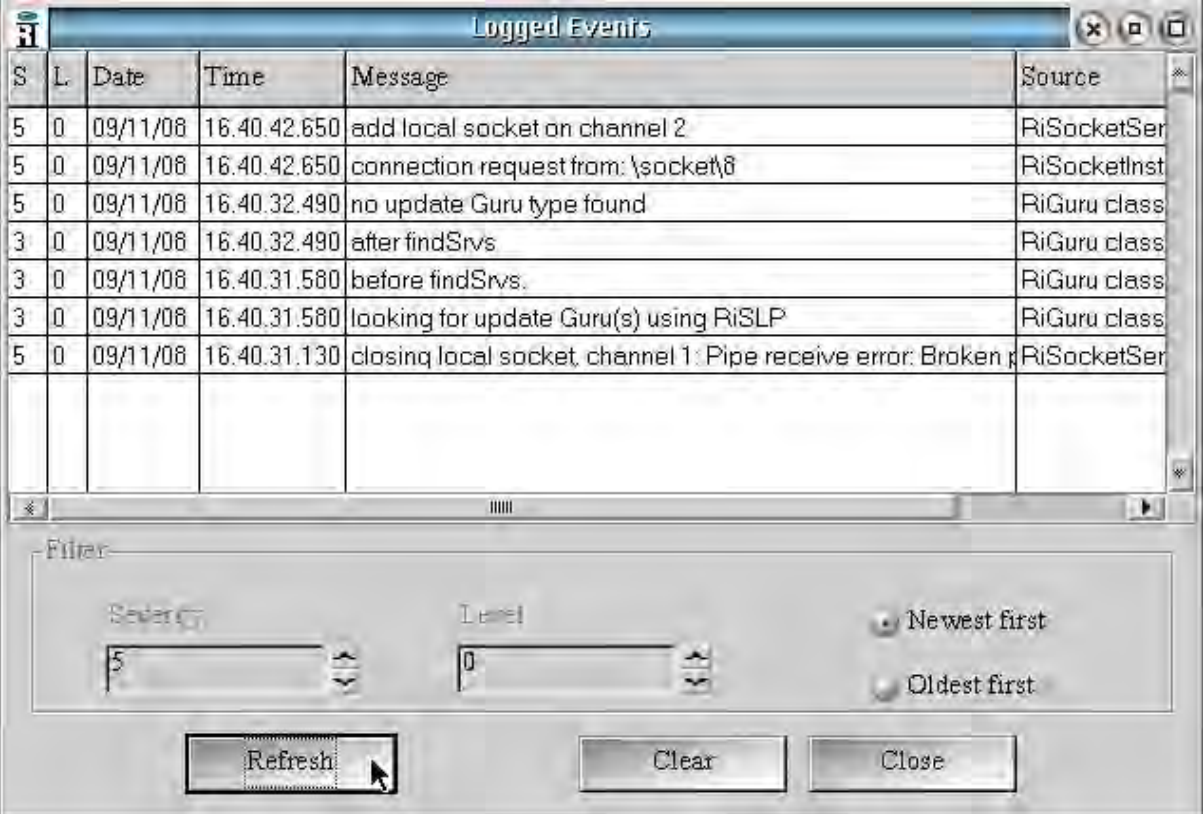
Selecting **System > Message** results in a Logged Events window being displayed. [Figure 4.4](#) The Logged Events window displays messages being sent between Guru and Guru based applications.

**Severity (S)** is either 1, 3, or 5. When a different severity level is selected and the Refresh button is clicked, the list will be updated with all messages with the selected severity and lower. For example, if severity of 1 is selected, it will only display messages with severity of 1; if severity of 5 is selected, it will display messages with severity of 5 and lower.

**Level (L)** is between 0 and 9. This is a measurement of the detail available in the message. First select a specific Level, click the Refresh button, and the list will be updated with all messages with selected level and lower. For example, if a level of 0 is selected, it will only display messages with level of 0; if level of 7 is selected, it will display messages with level of 7 and lower.

To change the order of the display, select Newest first or Oldest first, and click the Refresh button. To clear all the messages being displayed, click the Clear button. To close the Logged Events Window, click the Close button.

FIGURE 4.4 LOGGING EVENTS WINDOW



S	L	Date	Time	Message	Source
5	0	09/11/08	16.40.42.650	add local socket on channel 2	RiSocketSer
5	0	09/11/08	16.40.42.650	connection request from: \socket\8	RiSocketInst
5	0	09/11/08	16.40.32.490	no update Guru type found	RiGuru class
3	0	09/11/08	16.40.32.490	after findSrvs	RiGuru class
3	0	09/11/08	16.40.31.580	before findSrvs.	RiGuru class
3	0	09/11/08	16.40.31.580	looking for update Guru(s) using RiSLP	RiGuru class
5	0	09/11/08	16.40.31.130	closing local socket, channel 1: Pipe receive error: Broken p	RiSocketSer

Filter:

Severity: 5      Level: 0       Newest first  
 Oldest first

Refresh      Clear      Close

The Logging Events window displays messages being sent between Guru and Guru based applications

# TRANSFERRING TEST DATA

Guru Agent Editor is used to create Guru Agent configuration files. Guru Agents are used to perform automated transfers to local or network storage destinations at regularly programmed intervals or manually executed. This document describes, primarily, the 'Copy' and the 'STDF Copy' Guru Agents.

The **Copy** type is used to perform automatic copying of files. It can perform automated copy functions from one Guru to another, from a Guru to a local or network mounted file system, or from a Guru to designated FTP locations.

It can operate on multiple Guru sources as well as multiple destinations of any type. FTP destinations can use standard SOCKS proxies to connect to FTP destinations outside of the local network.

## FILE COPY GURU AGENT

Open Guru Agent by selecting **Apps > GuruAgent** from the Guru control bar. The left half of the window displays the data sources in a set of tabbed panes, the right contains data destination. In addition, there are pull down menus, found at the top of the program that allow

for configuring a Guru Agent, loading and saving of settings as well as adding and removing of data sources and destinations.

Loading a file for editing is accomplished by selecting the pull down menu **File > Open**. This presents a dialog box with a list of available Guru Agent setting files for editing. Select a file, and then select the **OK** button. Clicking the "Select Type" button allows for the selection of different types of files to be displayed, this can be useful if a GuruAgent settings file has been saved as a different type (or object class).

Similarly, selecting **File > Save** or **File > SaveAs** causes a file to be saved back to Guru. Save overwrites the previous file; SaveAs causes the creation of a new file, thus preserving the old one.

*NOTE: Previous versions are always retrievable using the Guru "History" feature.*

The Settings pull down menu has three categories of settings: Execution, Appearance and Messages/Errors. These are settings that control how the Guru Agent will run, when it will run, and how often it will run.

The pull down menu **Settings > Execution** displays a dialog window. The Execution settings control what type of copying will occur, how often the agent will run as well as whether it runs automatically at the specified rate (auto type), only at Guru startup (startup type), or only



when manually executed, such as from the Guru App selection button (Manual type).

*NOTE: The selections “Regular Copy Agent” versus “STDF Copy Agent” refer to the manner in which source files are selected for copying. The primary difference is that selecting “STDF Copy Agent” causes the pieces of the STDF file to be assembled prior to being copied. For non-STDF file, the “Regular Copy Agent” selection should be used.*

The Appearance dialog box is displayed by selecting the **Settings > Appearance** pull down menu.

It allows setting parameters such as whether a visible window is displayed while the agent is running (normally this is de-selected). In addition, this provides the option to allow the window to automatically close after the agent finishes running (this is the default case).

Sometimes it can be useful to allow the agent to keep running, after it has finished its task, for debugging purposes. Note that if “Auto Close” is not selected, the agent will not automatically terminate after it completes its task. As a result, the agent will not automatically run again until after the agent has been manually terminated.

The settings for “Screen Location” and “Screen Size” rarely need to be modified but are provided as a convenience to the user.

The Messages/Errors dialog box can be displayed by selecting the pull down menu: **Settings > Messages/Errors**. It allows the user to

select the types of errors that will be logged by the agent as it runs. There are four choices available:

0: No Logging of any sort

1: Logging only errors. For example: Couldn't find destination directory

2: Log Non-Errors as well as Errors. This includes lists of files that were successfully copied, and so on.

3: Debug Mode Logging. This enables logging of internal program events that are not normally of interest to most users.

## SOURCE SETTINGS

The left area of the main application window represents the ‘Source’ information. This defines what needs to be copied and where it can be found. There can be as many sources as necessary. In order to add more sources, select **Edit > Add Source**; this causes a new data source being displayed (for example, 'source1', 'source2', etc.). You can add as many sources as desired. Delete a source by first selecting it (so that it is displayed) and then select **Edit > Del Source**.

The field **Match On** defines the Guru keys that are used to fetch pertinent data. What is entered here is a comma separated list of keys, or key=value pairs, that uniquely identify the data that is to be fetched. For example: 'ri.sys.ObjClass=RiAdminLog'. This would cause any file in the source location, that had that particular key/value pair, to be included in the group of files to be copied.

*NOTE: When using the agent to assemble STDF or ATDF data logs, the Match On selection string should include "ri.sys.ObjClass=RiTestData, ri.sys.Type=summary"*

The **Type** selection: currently only Guru Sources are allowed, therefore the selection box only allows for source selection of type 'Guru'.

The **Location** field specifies where the source is located. Legal entries here are either the word 'local' which implies that the 'Local Guru' is to be the source for the data. Otherwise any IP address or URL can be specified. An example would be '[www.roos.com](http://www.roos.com)'. Additionally, the IP address or URL, a colon and port number is optional for situations where a non-standard Guru port is being accessed. For example: 192.168.1.123:5000 0.

**Proxy Info** allows for a proxy to be used as a means of accessing the source location. A proxy can be defined as an HTTP proxy, a SOCKS4 proxy, or a SOCKS5 proxy. Clicking on the 'Proxy Info' field will bring up a dialog that allows selection of the type of proxy as well as the relevant required information e.g. hostname, proxy port address, proxy username and password (if needed).

**Copied Files Tag** defines a key that will be set after the copy operation is successfully completed. This is used in conjunction with the check box: 'Ignore Copied Files', to avoid recopying files that have already been copied.

**Ignore Copied Files:** This check box works in conjunction with the "Copied Files" entry. The default state for this is to be selected. If selected, any files that have already been copied, will not be copied again. De-selecting this will result in files being copied even if they have already been previously copied.

**Ignore Invalid Files:** Occasionally a corrupt or invalid file may find it's way into the file system. If a file is determined to be corrupt, incomplete or otherwise invalid, it automatically gets tagged as such. The default setting for this check box is that it be selected; this results in invalid files being ignored. De-selecting this check box will result in the agent re-attempting to gather and copy those invalid files. Note that this is primarily related to the STDF files option as they are pieced together from separate files.

## DESTINATION SETTINGS

The area on the right hand side of the main application window represents the 'Destinations'. This defines where files will be copied as well as their final names. There can be as many destinations as necessary. To add more destinations, select **Edit > Add Destination**. This causes a new Data Destination to appear in the right hand area of the application, as a tabbed pane. Delete a destination by first selecting it and then select **Edit > Del Destination**.

The **Type** field can be any of three possible values: 'Guru', 'ftp', or 'file'. This identifies the type of destination being defined.

- 'Guru' causes source files to be copied to the specified destination Guru.



- ‘ftp’ causes an FTP connection to be opened using the specified values for Connect info, Location, Rename Template and Proxy Info.
- ‘file’ type will cause the data to be copied to a file system location using the specified values for Connect info, Location, Rename Template and Proxy Info.

The remaining fields will display if needed for the different destination type as described below.

The **Location** field describes either the IP address, ftp location or file system location that will be connected to when copying files to this destination. Valid entries here are IP addresses or URLs followed by an optional port number, or else a valid file path name.

The **Rename** Template is used to automatically create filenames from Guru keys. Within Guru, files are specified by sets of key=value pairs. Often these files have no useful filename that can be used to distinguish one file from another once copied to an ftp or file system location. This field allows a name to be automatically created from Guru keys. Any desired text can be entered here. In addition any value in angle brackets ‘< >’ is treated as the name of a Guru key. For example:

```
Date1<ri.dlog.StartTime>_<ri.dlog.Lot>_<inx.dlog.TestMode>_<inx.dlog.TestType>_<ri.dlog.Tester>_<ri.dlog.Testplan>.std
```

# GETTING ASSISTANCE

This section provides general information for generating and exporting relevant data to Roos Instruments support. Reference the [troubleshooting section](#) for helpful tips and guides for debugging and diagnosing test issues.

Contact information and support hours can be found in the [Additional Help](#) section of the About this Manual chapter.

---

## SENDING DATA TO ROOS INSTRUMENTS

Support can be typically be expedited by including software objects related to the problem in the service request as well as the version of the software application(if applicable):

- The name and version number of a software application can usually be found in its' **Help > About** menu options.
- If a software 'Walkback' error is encountered, select **SAVE** from the error dialog window to save the error message as a

'walkback.log' or 'vterror.log' file. The file is saved in the program directory, d:\RiApps\GuruApps\#####(App number).

- To send information related to test applications or resources such as calibration information, software definitions, test plans or test data, use the [Export Simulation](#) feature found in the Troubleshooting chapter.

### CREATE .ZIP FILE

Files that are not exported as .gzp files from Guru Browser should be contained in a zip a file before sending it to RI support.

#### To create a zip file:

1. Open a command terminal.
2. Enter the commands:

```
cd d:/folder/name/
```

```
zip 'zip file name' 'name of file(s) to be zipped'
```

Example: `zip guru.zip d:/RiGuru/`

# DIAGNOSTICS

---



General Diagnostic  
Information for:

- Theory and Planning
- Operator Interface
- Diagnostic Kit
- Diagnose Procedure
  - Preparation
  - Full or Targeted
  - EPC

Use Diagnostics to prepare  
for Calibration or while  
Troubleshooting.

# OVERVIEW

This chapter provides an introduction to diagnostics and the automated fault detection of instruments on Cassini test systems. The information provided is the recommended practices and procedures for performing instrument diagnostics to help develop corporate policies for releasing a test system to production. A detailed explanation of the software interface is provided with a description of the standard [Diagnostic Kit](#) and its software resource definitions. The [Diagnostic Procedure](#) section provides step-by-step instructions for conducting diagnostics on Cassini instruments and the EPC Controller.

## PRINCIPLES OF DIAGNOSTICS

Cassini diagnostics are used to test an instrument's operational capability. The instrument's internal components are exercised to detect hardware faults in a controlled test environment, performing various measurements to verify operation, consistency, and repeatability. These tests provide a simple pass or fail results based on factory defined parameters of acceptance. Two modes of

evaluation are expressed in the diagnostic tests list available to the user as either 'diagnose' or 'verify' in the test names. Collectively, both types of tests in the test list are referred to as 'diagnostics' on the Cassini test system with the descriptions of each as follows:

1. Diagnose tests check fundamental hardware functionality of an instrument's internal components. A damaged or malfunctioning component will cause the diagnose tests to fail.
2. Verify tests check the measurement capability of an instrument to insure that it is compliant with performance specifications of a calibrated instrument. This includes conducting tests to gauge the repeatability of measurements using fixed instrument and I/O port setup conditions in a controlled test environment. In the case of RF instruments, the diagnostics can involve several interconnected instruments.

*NOTE: For some RF instruments, verify tests are inherently dependent on the instrument's calibration. An improperly executed or invalid instrument calibration can also cause verify tests to fail.*

An aspect unique to diagnostics on Cassini ATE are the variable instrument configurations of the test system. Because of this, diagnostic tests available to the user are designated specifically for the configuration of TIMs installed. The instrument arrangement on the test head is addressed by matching a corresponding Diagnostic/Calibration Interface Plate and diagnostic/calibration test list to each unique test head instrument configuration. This Diagnostic/Calibration Interface Plate provides the specialized TIM interface blocks and

cross-instrument connections specific to the test system that is required to conduct diagnostics, see [Figure 5.7](#) for an example.

*NOTE: Changes to the TIM layout or TIM upgrades may require physical changes to the diagnostic plate and/or changes to the diagnostic test list.*

## SOFTWARE INTERFACE

In software, the diagnostics for a Cassini test system are managed by a specialized user interface called the Diagnostic Executive. The interface provides the list of all instrument diagnostics for the test system and a console for executing, viewing, and saving diagnostic results. Access to the diagnostic executive is enforced by the user login permissions to limit viewing and execution to authorized personnel only. Reference the [User Interface](#) section in this Chapter for more information.

## WHEN TO PERFORM DIAGNOSTICS

Diagnostics are an essential tool to confirm that the instruments in a Cassini test system are operational. As such, diagnostics are satisfactory for use in the acceptance process or to confirm that a Cassini system configuration is ready for production use. Listed below are the recommended instances for performing diagnostics on an instrument or Cassini test system:

- To verify operation of a test system instrument

- Before a system or instrument calibration.
- During a Cassini test system acceptance process.
- Before releasing a Cassini test system to production.
- When a TIM is exchanged or replaced, prior to its first use.
- When troubleshooting a TIM that is suspected of damage or malfunction.

## TIM-SPECIFIC DIAGNOSTICS

Some instruments require unique and/or supplemental procedures in addition to those outlined in this chapter. The below hyperlinks provide instructions and procedures for these TIMs:

[RI8589 FetPulser Supplemental Diagnostic Hardware](#)

[RI8589 FetPulser Diagnostic Instructions](#)

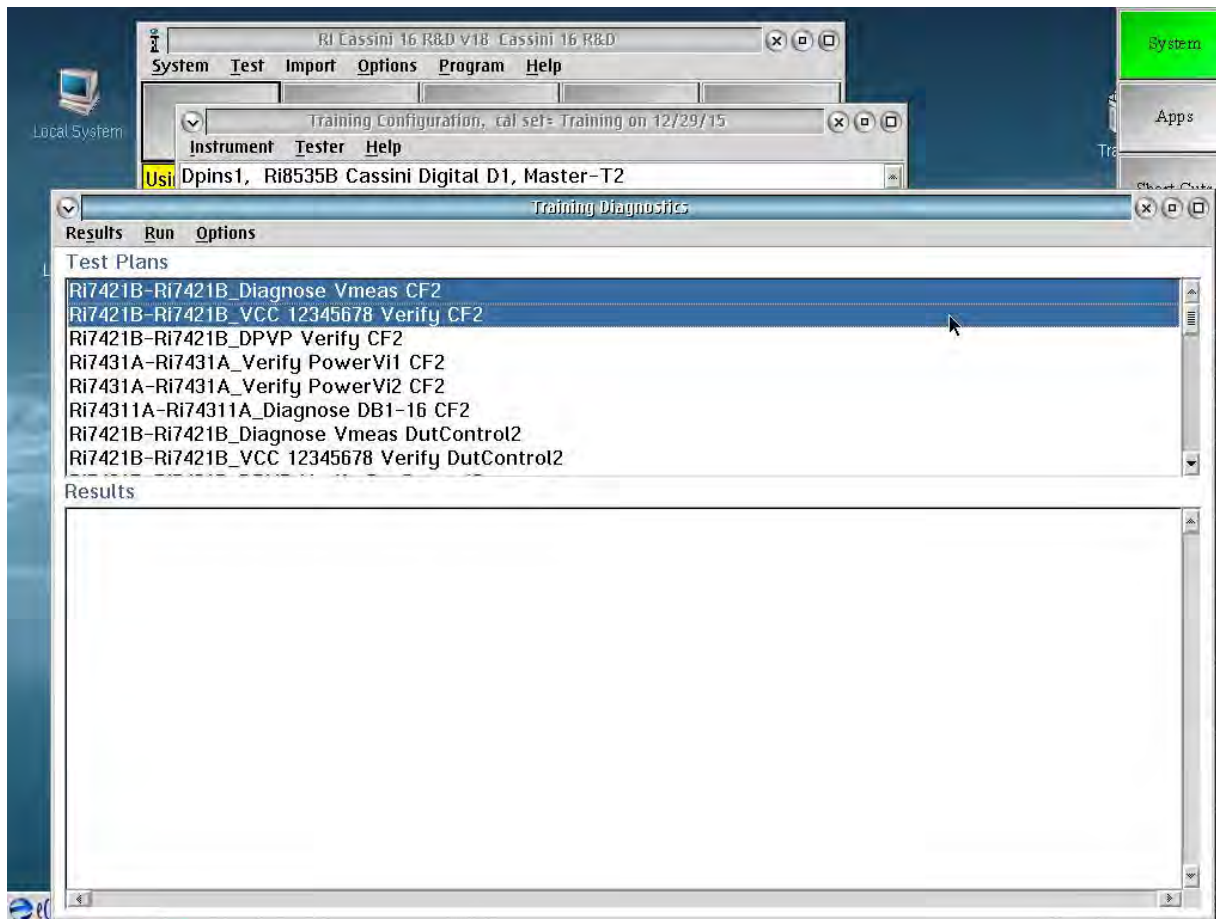
## SUPPLEMENTAL DIAGNOSTICS

Additional diagnostic tools are available on Cassini test systems. These include diagnostic tools for the RIFL communication hub and the disk drives in the EPC Controller. While the supplemental diagnostic tests provide additional system and instrument information, they are not required for validating the performance or operational capability of a Cassini TIM. The supplemental diagnostics are described in more detail in the [Diagnostic Procedure](#) section.





# USER INTERFACE



## TOPICS

[Opening the Diagnostic Executive](#)

[Diagnostic Executive Window](#)

[Menu Options Details](#)

[Running Diagnostics](#)

## OPENING THE DIAGNOSTIC EXECUTIVE

Diagnostics for Test Instrument Modules (TIMs) on Cassini test systems are accessed using the Diagnostic Executive. In the following section, this UI and its features are described.

**Access to the Diagnostic Executive is restricted to users with the “Maintenance” permission enabled. Check with the system administrator for more information on user access.**

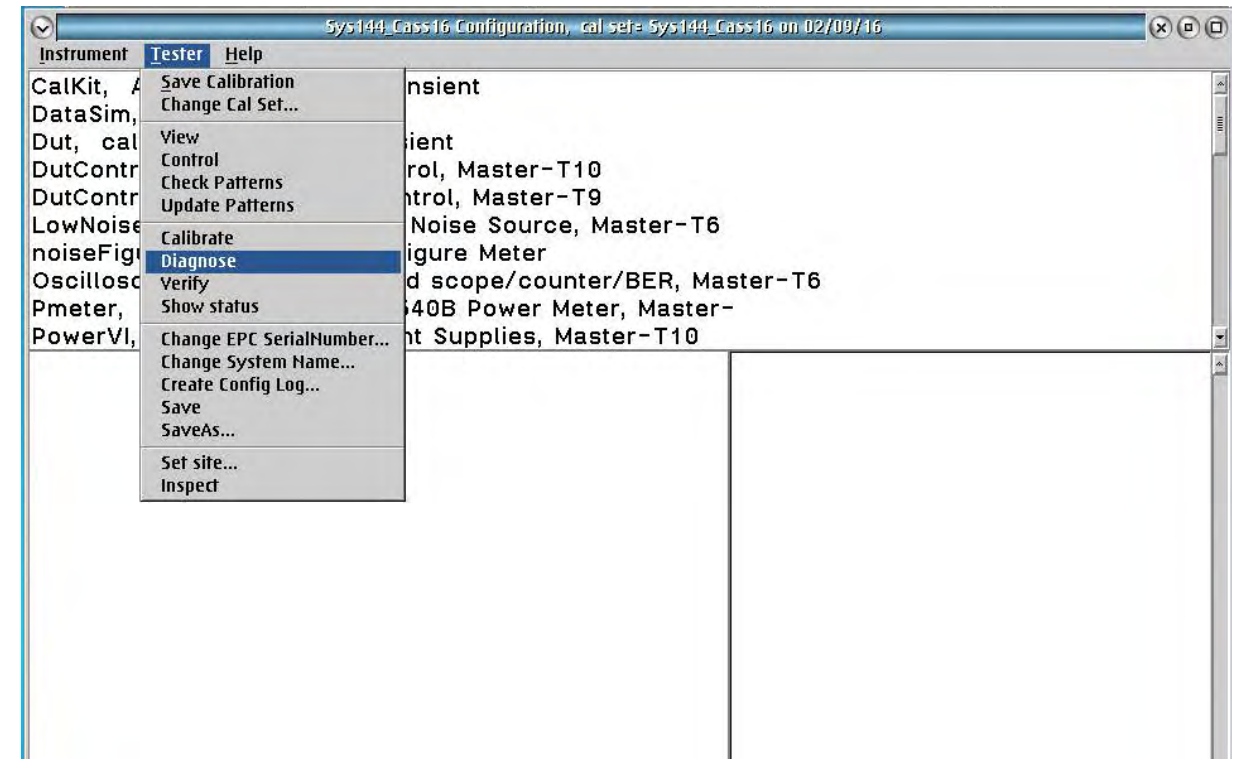
The Diagnostic Executive window is accessible from the Tester Configuration Window. It can be accessed two different ways, giving the user access to different set of diagnostic test plans.

To access the default system diagnostics for all TIMs in the test system (**recommended method**):

1. Open a [Tester Configuration Window](#).
2. From the menu options select **Tester > Diagnose**, as shown in [Figure 5.1](#).

This option populates the diagnostic executive (example shown in [Figure 5.3](#)) with an ordered list of factory supplied Diagnose and Verify test plans for the specific TIM configuration of the Cassini test system. The test plans are organized in the list to be executed sequentially from top to bottom to perform a complete diagnostic of the test system.

FIGURE 5.1 OPENING DIAGNOSTIC EXECUTIVE



The Diagnostic tests are accessed from the **Tester > Diagnose** menu from the Configuration Window.

In addition to the standard diagnostic list, users can select alternative diagnostic lists to populate the Diagnostic Executive. These alternative diagnostic test lists are typically used when updating the system diagnostics to add support for upgraded or newly added TIMs.

To access an alternate diagnostic list:

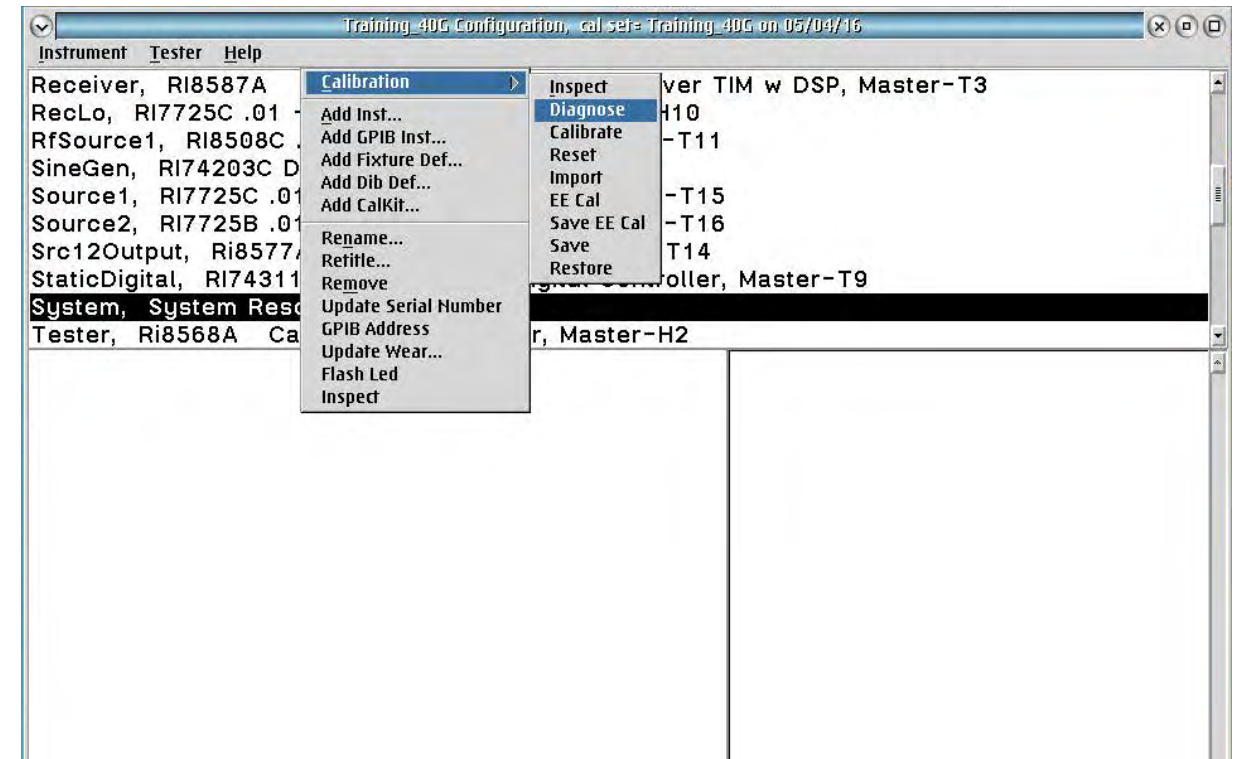
1. Open a Tester Configuration Window.

2. Right mouse button click on the **System** instrument in the Tester Configuration window.
3. Select **Calibration > Diagnose...** from the menu as shown in [Figure 5.2](#).

To save an alternate diagnostic list as the default:

1. Access the alternate diagnostic list using the steps above.
2. From the Configuration Window, select **Tester > Save** from the menu options.
3. Select OK from the 'Tester name, OK to save' pop-up window.

FIGURE 5.2 OPENING ALTERNATIVE DIAGNOSTIC TEST PLAN LIST



Alternate Diagnostic tests are accessed from Right Mouse Button (RMB) click the **System > Calibration > Diagnose** menu from the Configuration window.

## DIAGNOSTIC EXECUTIVE WINDOW

The specialized user interface provides a console for executing RI diagnostic test plans with factory set limits and displaying the pass/fail results. This section describes the various options in the UI that are available to the user.

### USER INTERFACE LAYOUT

The Diagnostic Executive window, shown in [Figure 5.3](#), is divided into two panes - Test Plans, and Results. The Test Plans section displays diagnostic tests in a scrollable list. This test list is populated based on the user's selection of either an individual TIM, or the factory default diagnostics for all TIMs in the test system, see [Diagnostics Procedure](#) for information on diagnostic list selection. Diagnostic tests can be selected (highlighted with a blue background) by Left Mouse Button (LMB) clicking on the desired test. A selected test can be unselected by LMB clicking on the highlighted test.

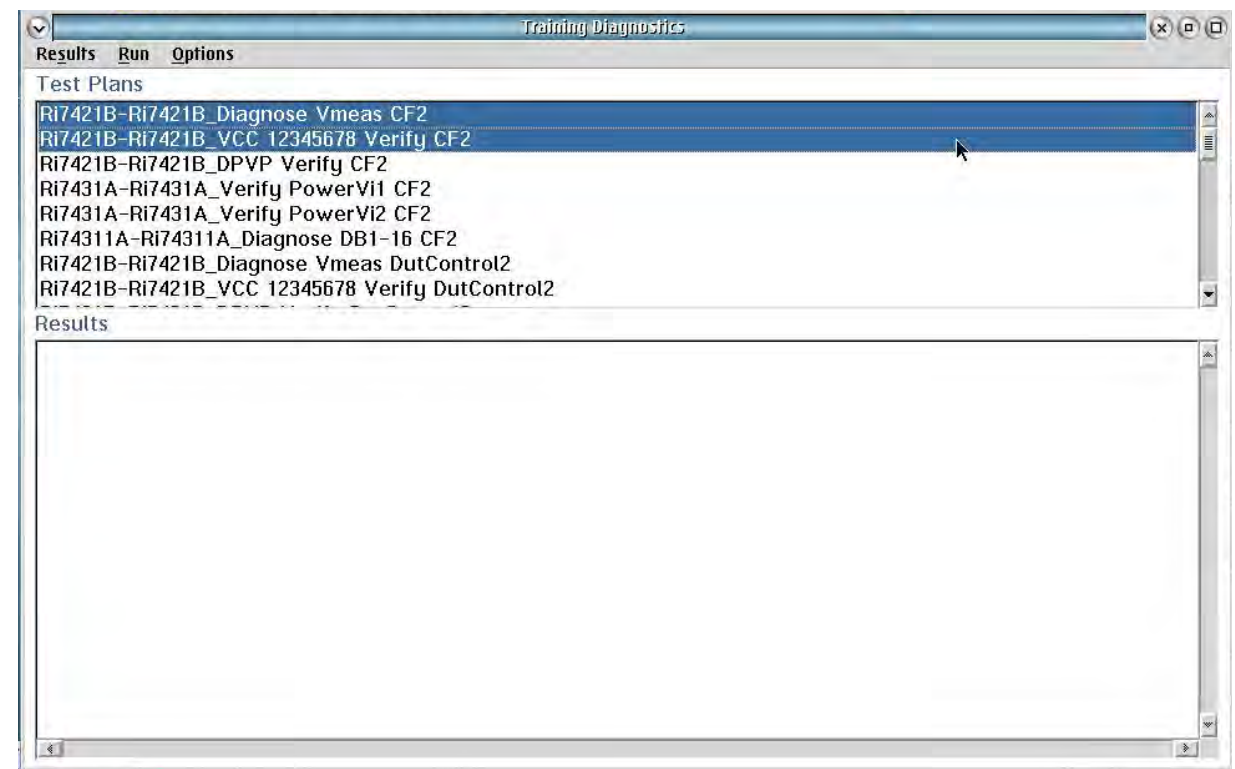
The Results section is a text display that provides user feedback of executed diagnostic tests, diagnostic pass/fail results, and measurement data. When diagnostics are executed, the name of the test that is currently running is displayed in the Results. Once completed, the pass or fail result is appended to the end of the corresponding test plan name, i.e - "RI7421b-RI7421B\_Diagnose Vmeas CF2...Pass." The default result settings display a passing diagnostic test with the word 'Pass' appended. A failed results appends "FAILED!", followed by measurement data in the associated diagnostic test that failed.

## MENU OPTIONS

### Results Menu

The results menu is used for exporting diagnostic information and/or measurement data from the Diagnostic Executive. The **Save to File...** menu option allows the user to export all information displayed in the Results pane to a text file. This command opens an OS2 file directory window to save the diagnostic text file to the local file system.

FIGURE 5.3 DIAGNOSTIC EXECUTIVE WINDOW



The Diagnostic Executive is divided into two panes: The Test Plans (top pane) provides the list of diagnostic tests for the selected TIM or TIMs. The Results (bottom pane) is a text console that displays diagnostic results.



*NOTE: The 'Save to File...' menu option is the recommended procedure for exporting and sharing diagnostic information with RI support. The 'Save to Guru' menu option is reserved for RI internal purposes only.*

**CAUTION:** Save to an USB flash drive (Max 2/4 GB Fat16 (32Kib, NOT NTFS), networked drive, or to the D:/ drive (as a temporary option).

## Run Menu

The run menu provides the different options available to the user for executing diagnostic tests:

**Unselect All Tests** - this menu option will remove the selection (highlight) for all currently selected diagnostic tests in the Test Plan pane. By default, all test plans are unselected when the Diagnostic Executive is launched.

**Selected** - this menu option will execute all diagnostic tests that have been selected (highlighted) in the Test Plan pane. Selected tests will be executed as a batch in descending order starting from the top of the diagnostic list.

**All** - this menu option will execute a self test (if available) and all diagnostic tests in the Test Plan list.

*NOTE: When this option is executed, all diagnostic tests in the list will be executed regardless of what test plans are selected.*

**Self Test** - this menu option will execute low-level diagnostic checks of source TIMs mounted in an Aux Rack. See the [Diagnose Procedure](#) for more information on self tests.

## Options Menu

The options menu provides diagnostic settings available to the user in the diagnostic executive:

**Select Cal Kit** - this menu option will allow the user to add a calibration kit software definition to the tester configuration.

**Add Power Mtr** - this menu option allows the user to add an RF power meter instrument to the tester configuration. A GPIB Instrument Pod must also be attached. When prompted, enter the same GPIB address as set on the Power Meter.

**Inspect Symbols** - this menu option is for RI internal purposes only.

**Show All Results** - this menu option will display all measurement data from executed diagnostics tests in the Results pane for both passing and failing tests.

**Show Fails Only** - this menu option will display measurement data associated with executed diagnostics tests in the Results pane for only for tests that fail. This is the default result display setting when the Diagnostic Executive is launched.

**Open Test Plan** - this menu option will open the test plan of a selected (highlighted) diagnostic test from the Test Plan pane. If multiple test plans are selected, the first test plan listed will be opened.

---

**WARNING: Altering or modifying diagnostic test plans will void the performance specifications of the Cassini test system. Do not open diagnostic tests without supervision from or prior approval of RI support.**

---

FIGURE 5.4 DIAGNOSTICS RESULTS EXAMPLE

The screenshot shows the 'Training Diagnostics' application window. The 'Test Plans' pane lists several tests, with 'Ri7421B-VCC 12345678 Verify CF2' selected. The 'Results' pane displays the following data:

Test	Result	Data
Ri7421B_VCC 12345678 Verify CF2	FAILED!	
VCC1	Fail	10.5769322151 ; 6.41592799141 ; 1.24685585746 ; -3.79491013931 ; -7.85701989597
icc1 sense	Fail	-516.683321907 u; -0.00124824620516 ; 0.00176277286019 ; 0.039291060859
icc1 set	Fail	493.501831407 u; 0.0010604642087 ; -0.00506239424399 ; -0.00537013297448
VCC2	Fail	10.7228152135 ; 6.39844388673 ; 1.64298010402 ; -3.50314414253 ; -8.40558368018
icc2 Sense	Fail	79.1546071194 u; 541.679220757 u; 0.00864907275017 ; 0.0604269081316
VCC3	Fail	10.0535018314 ; 5.62067441779 ; 1.63095978206 ; -3.12013297448 ; -8.40558368018
icc3 Sense	Fail	39.9046146244 u; 747.534627613 u; 0.00725192048241 ; 0.0581582550679
icc3 Set	Fail	-39.9172467647 u; -299.995732947 u; -0.00185929061439 ; -0.0296270256106
VCC4	Fail	10.4550898606 ; 5.82693221514 ; 1.64298010402 ; -3.11904021793 ; -8.99457945645
icc4 Sense	Fail	41.9114680707 u; 709.159813521 u; 0.00542825702643 ; 0.071741433805
VCC5	Fail	10.7162586742 ; 5.96625867427 ; 1.64844388673 ; -3.11904021793 ; -7.85155611326
icc5 Sense	Fail	6.27353810464 u; 659.051464002 u; 0.00563063285757 ; 0.0430146683895
icc5 Set	Fail	-73.5483232844 u; -380.784375182 u; -0.0031137144522 ; -0.030838032512
VCC6	Fail	10.7293717527 ; 5.97937175278 ; 1.07693221514 ; -3.11904021793 ; -7.85155611326
icc6 Sense	Fail	44.6537482052 u; 492.943729977 u; 0.00564978816237 ; 0.0499404844576
VCC7	Fail	10.7402993182 ; 5.28601772673 ; 1.78777034587 ; -2.9797137588 ; -8.56239424399
icc7 Sense	Fail	6.7328593845 u; 796.76579658 u; 0.00799287135894 ; 0.0745146707572
icc7 Set	Fail	-69.8627921471 u; -202.381558125 u; -0.00207399351999 ; -0.0304904558786
VCC8	Fail	11.1298670255 ; 5.9902993182 ; 0.955089860682 ; -3.79491013931 ; -7.83953579129
icc8 Sense	Fail	14.9838370798 u; 604.03764466 u; 0.00700955093379 ; 0.0840013995368

In the example above, fail results are shown for the RI7421B Instrument. The diagnostic test results are listed from left to right: measurement name, measurement result, and all values of the measurement.



## RUNNING DIAGNOSTICS

The function of the Diagnostic Executive's role is to provide a UI to streamline the diagnostic process on Cassini. Along with providing a dedicated console for running diagnostics, the Diagnostic Executive automates and runs several features in the background that a user should be aware of when using this interface:

- Test plans are automatically compiled and executed.
- Diagnostic test and measurement limits are selected by the executive.
- Operating system memory is minimized for test plan compiles.
- Test plan debug mode is disabled.

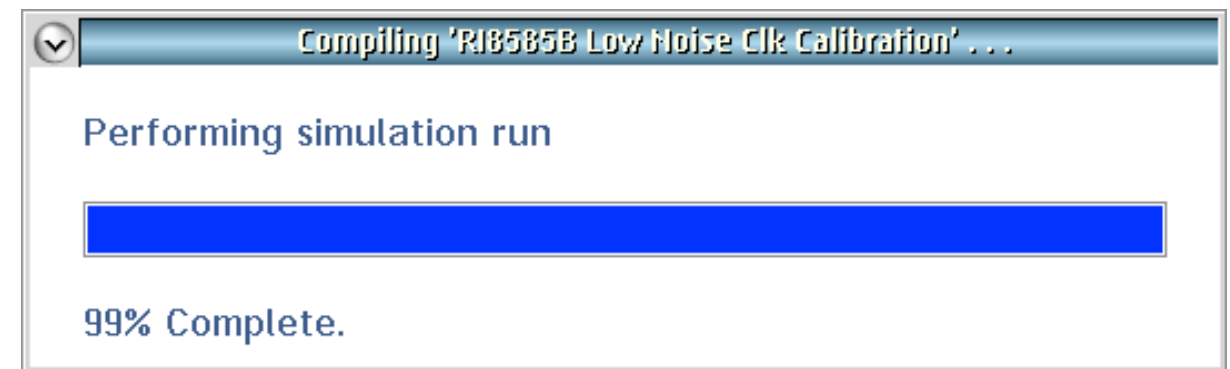
The diagnostic test list is populated when the Diagnostic Executive is first launched as described in the previous section. To run all tests as a batch process by selecting **Run > All**. Alternatively, the user highlights the test or tests to execute by left-clicking on them to select. With the desired tests highlighted, the user can choose to run them by selecting **Run > Selected** from the menu options as shown in [Figure 5.6](#).

Once the diagnostics have been initiated by either one of the described methods, the executive automates diagnostic test compile and execution. The test compile progress bar is displayed to the user (an example is provided in [Figure 5.5](#)), and then executed uninterrupted. If user input or intervention is required, an operator

prompt will appear with specific instructions, and the test system will pause until the user selects the OK button in the prompt.

The results of diagnostic tests are automatically generated and provided in the Results pane. While a diagnostic test is executing, the name of the test is displayed in the text field with an ellipsis (for example "RI7421b-RI7421B\_Diagnose Vmeas CF2..."), signifying that the diagnostic test is currently being conducted. Upon completion, the words "Pass" or "FAILED!" will be appended to the end of the ellipsis to denote the final status of the diagnostic test, i.e - "RI7421b-

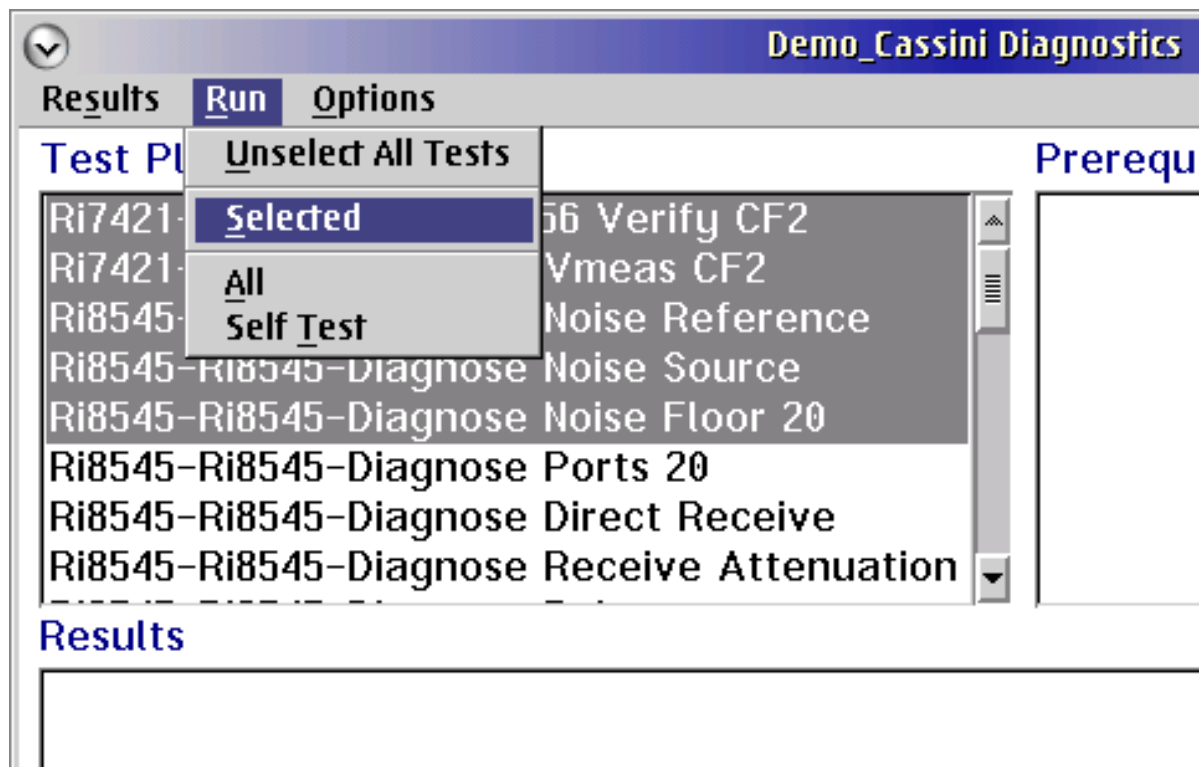
FIGURE 5.5 COMPILE PROGRESS BAR



The Diagnostic Executive automates test plan compiles and displays a progress bar prior to test execution as show above.

Ri7421B\_Diagnose Vmeas CF2...Pass.” The default Result settings display passing tests in this manner, with failing test displaying “FAILED!” followed by the results of all measurements in the associated diagnostic test including the pass/fail status of individual measurements. See [Figure 5.4](#) for an example of a failed diagnostic test. The result settings can be changed to display all measurements regardless of the test status by the user (see the [Menu Options](#) in the previous pages of this section for more information). The Diagnostic Executive will continue on to subsequent diagnostic tests until all selected test are completed.

FIGURE 5.6 RUNNING DIAGNOSTICS



Selected diagnostic test plans can be executed using the menu options shown.

# DIAGNOSTIC KIT

## SUMMARY

- 1. Diagnostic Hardware**
- 2. Adding the Diagnostic/Calibration Interface Plate**
- 3. Initializing a Diagnostic/Calibration Interface Plate**

## HARDWARE

Diagnostic Kit provides all of the components needed to perform diagnostics and/or calibration of the Cassini test system. Included in every kit is a specialized bottom plate called a Diagnostic/Calibration Interface Plate. The interface plate contains an 8-slot or 16-slot bottom plate with diagnostic TIM interface blocks that provide all the RF cross-instrument interconnect for performing both individual and RF system-level diagnostics of the instruments. Reference [Figure 5.7](#) and [Interactive 5.1](#) for examples of Diagnostic Kits and interface plates.

Diagnostic/Calibration Interface Plates are customized to match the Cassini configuration and specific instrument test head layout. To help manage the different possible configurations of the tester, every Diagnostic/Calibration Plate contains a unique serial number chip and label. These provide unique identifiers for the hardware for both the system software and service personnel to manage the administration of multiple interface plates and/or test system configurations. The ID chip is an Electronic Serial Number (ESN) that the Cassini software uses to automatically associate any calibration data (RiFixtureCal object) and add the fixture definition (RiFixtureDef object) that defines the instrument interconnect paths and default calibration values. On the Diagnostic/Calibration Plate are TIM interface blocks that provide access to ports and interconnect for exercising internal instrument functionality as well as multi-instrument functionality.

In addition to the Diagnostic/Calibration Plate, the diagnostic kit provides a protective transit case and contains additional cables and

RF adapters that are customized to the test system's diagnostic requirements. Examples of typical Diagnostic Kits are provided in [Figure 5.11](#) and [Figure 5.12](#). The transit case is marked with the interface plate's serial number and model number to uniquely identify its contents for service personnel.

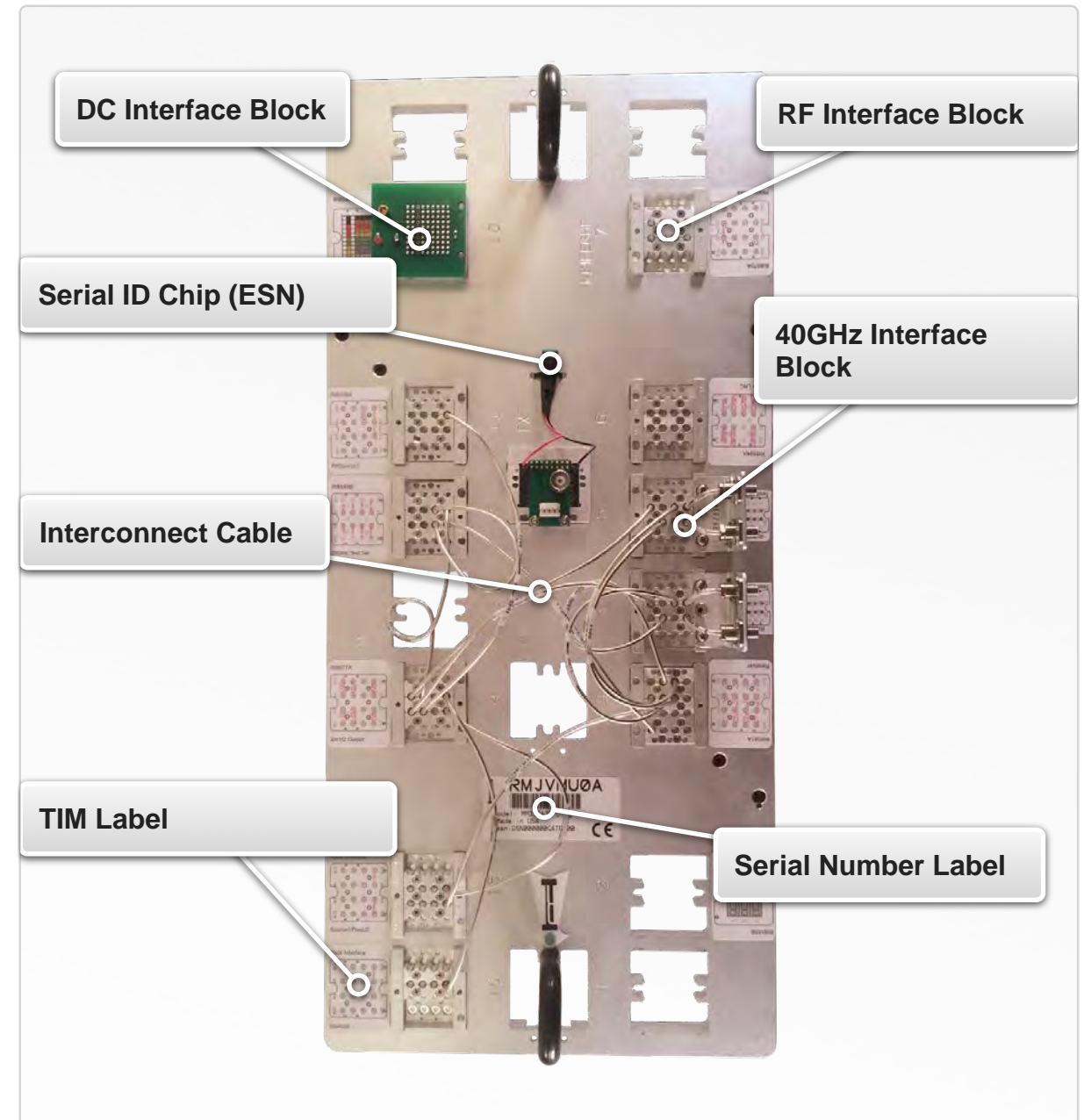
*NOTE: A single Calibration/Diagnostic Interface Plate can only be shared between multiple Cassini systems with identical TIM configurations.*

FIGURE 5.7 DIAGNOSTIC KIT EXAMPLE



The Diagnostic Kit above shows a Cassini 16 Diagnostic/Calibration Interface Plate (Diagnostic/Calibration Plate) in its protective transit

### INTERACTIVE 5.1 CASSINI 16 DIAGNOSTIC/CALIBRATION PLATE



The above example shows a typical Diagnostic/Calibration Interface plate with all the necessary interface blocks and RF interconnections of a test head configuration for 40GHz applications.



## SUPPLEMENTAL DIAGNOSTIC HARDWARE

The RI8589 FetPulser TIM requires the use of a diagnostics block shown in [Figure 5.8](#). The block is not integrated into the diagnostic plate and is intended for use on an as-needed basis. The diagnostic block activates the interlock and provides interconnect between instrument resources to perform diagnostics.

---

**WARNING: Do not connect the FetPulser diagnostic block to the TIM until the RI8589 has been powered up and checked-in to the test system configuration.**

---

FIGURE 5.8 RI8589 DIAGNOSTIC BLOCK



The FetPulser diagnostic interface block

## ADDING THE DIAGNOSTIC/CALIBRATION PLATE

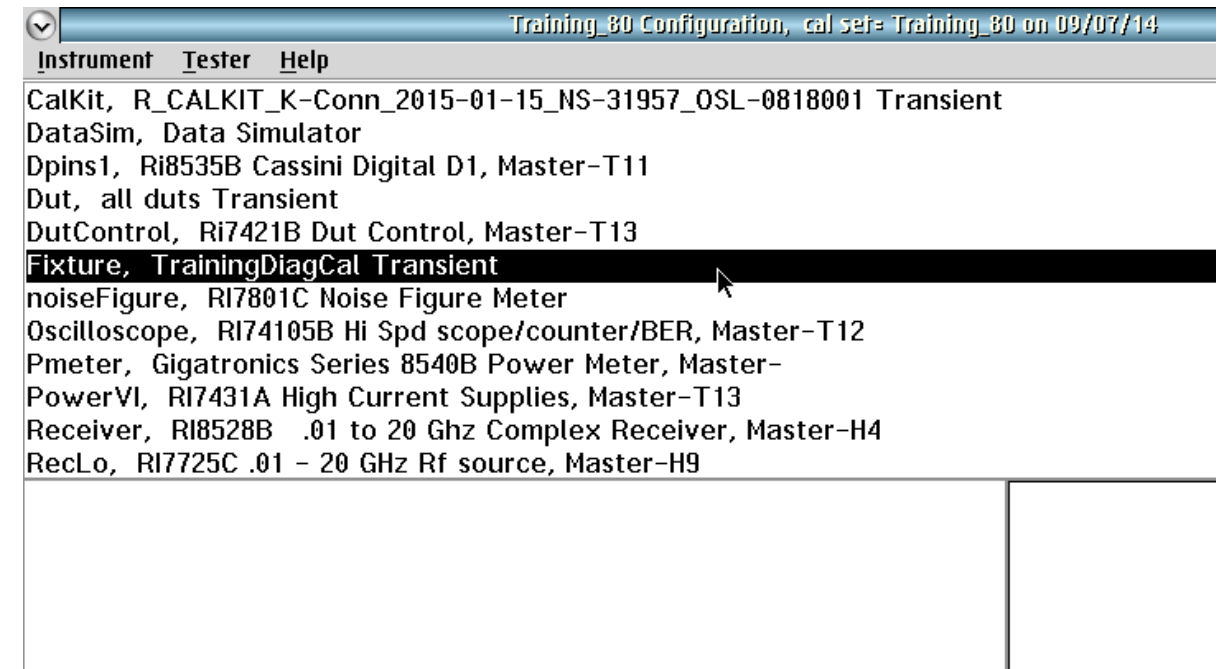
The Diagnostic/Calibration Interface plate must be docked to the test head and its' associated software definition, i.e - 'Fixture' instrument must be loaded in the Configuration window in order to run diagnostics. To add the Diagnostic/Calibration Plate to the Cassini configuration:

1. Place the Diagnostic/Calibration Plate on the test head and verify that the physical TIM layout matches the location of the TIM interface block locations on the Diagnostic/Calibration Plate.
2. Verify that the instrument names and test head slot locations in the Configuration Window match the corresponding TIM Label on the interface block locations of the Diagnostic/Calibration Plate.

*NOTE: In the Configuration window, the test head slot of an instrument is designated at the end of the instrument name by the suffix '-T' and then a number. For example '-T11' designates test head slot 11.*

3. [Dock the Calibration/Diagnostic Interface Plate](#) to the test head and perform a [System Check](#) to add the software definition to the system configuration.
4. The diagnostic plate will appear in the configuration window as a 'Fixture' instrument followed by a descriptive title of the diagnostic plate, see [Figure 5.9](#). The message window will report, "Fixture Added " followed by the Diagnostic/Calibration plate name.

FIGURE 5.9 DIAGNOSTIC/CALIBRATION INTERFACE PLATE



The Diagnostic/Calibration Interface Plate (highlighted above) appears in the system's configuration window as a "Fixture" instrument.



## INITIALIZING A DIAGNOSTIC/CALIBRATION PLATE

Initializing a diagnostic/calibration plate is the process of linking the electronic serial number (ESN) chip on the Diagnostic/Calibration Interface Plate with the software Fixture Definition (ObjectClass = RiFixtureDef). The Fixture Definition is created/edited with the Device Connection Editor application. Initialization is required when:

- A new diagnostic plate is assembled that has never been used on a Cassini test system.
- The serial ID chip on the diagnostic plate has been replaced.
- The diagnostic plate needs to be associated with a new or different fixture definition.

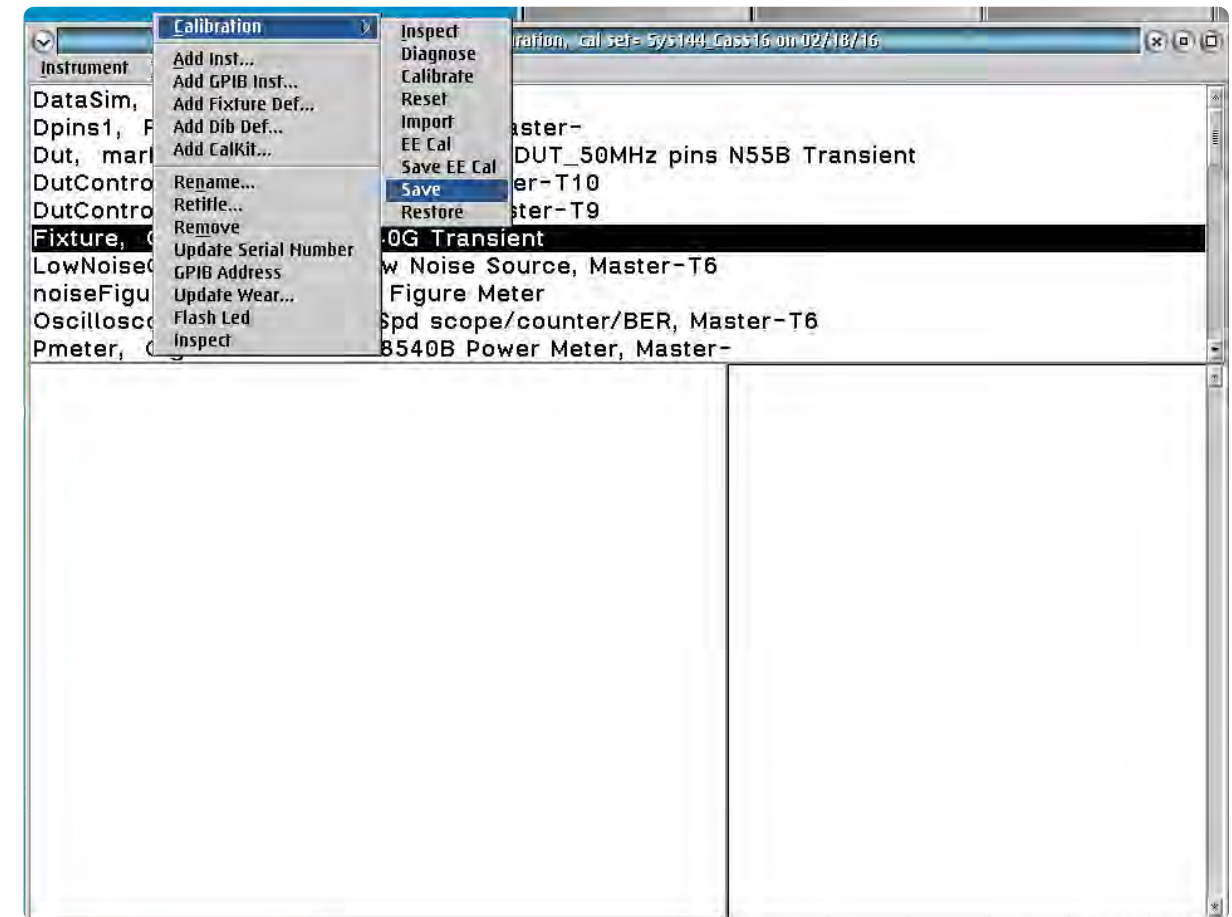
The initialization process only has to be performed one time for a diagnostic plate. All subsequent System Checks and System Startups will automatically load the software definition for the diagnostic plate.

*NOTE: Insure that the most up to date fixture definition for the diagnostic plate is imported in the Cassini's local Guru using Guru Browser before initialization. If the Cassini ATE is connected to a Guru Server, insure that the definition for the diagnostic plate was imported on any of the networked Cassini test systems.*

To initialize a diagnostic/calibration plate:

1. If not already completed, Login to the test system with user permission to start the latest/appropriate shortcut and access the Main System window.

FIGURE 5.10 INITIALIZING A DIAGNOSTIC/CALIBRATION PLATE



The fixture definition for the Calibration/Diagnostic Interface plate is linked to the ID chip on the plate by saving the active definition as a calibration as shown above.

2. Open a [Tester Configuration Window](#).
3. Open a [Messages Window](#).

FIGURE 5.11 STANDARD CASSINI 16 DIAGNOSTIC KIT

Description	QTY	RI Part Number	Label
16-Slot Interface Plate (Custom)	1	W1MFEGHG	D1
8" #12 PKZ Special Cable	2	W1MFEJXE	D2
SMA 20dB Attenuator	1	M6GSFV1A	D3
8" SMA to #12 PKZ Special	2	W1MFEJWB	D4
50Ω Termination	1	M5R1BE1A	D5
Adapter, custom #12 PKZ(f)-SMA(f)	4	MBH0VH1B	D6
Serial Number (SN) Harness	1	MJUMNF4B	-
Cal/Diag Fixture Block	1	MMXT225A	-

These standard items are included with all Diagnostic Kits as standard items.

4. [Dock the Calibration/Diagnostic Plate](#) to the test head and perform a [System Check](#).

*NOTE: If the ID chip has never been associated with a software definition and a System Check is performed, the message "No RIFixtureCal found for this esn:" followed by the unique serial number of the chip will be displayed in the Messages window. The*

FIGURE 5.12 DIAGNOSTIC KIT EXAMPLE 2

Description	QTY	RI Part Number	Label
Adapter, SMA(f)-SMA(f)	1-2	M6GVJT1B	D9
SMA 30dB, 50W Attenuator	1	MPG9M41A	D10
16" #12 PKZ(f) Cable	1	MRT4ZF1A	D11
RI8546 DC Cal/Diag Block	1	RIK0249A	-
RF 16 Port Cal/Diag Block	3-12	RIK0168A	-
RF 40GHz AUX Block	1-2	RIK0167A	-
RF Waveguide W12 Block	1-2	RIK0198B	-

The items above are examples of items included for custom applications /TIM configurations.

*fixture will not appear in the Configuration window until the serial number is associated to a software definition.*

5. From the Configuration Window menu options, select **Instrument > Add Fixture Def...** to open a list of fixture software definitions.

6. From the Select Fixture Def window, select the Title of the Fixture definition that will be linked to the Diagnostic/Calibration Interface plate's ESN and choose **select** to activate it.
7. Once added, a 'Fixture' instrument will appear in the Configuration window as shown in the example in [Figure 5.9](#).
8. In the Configuration window, left click on the Fixture to select it from the list.
9. Right click on the Fixture instrument and select **Calibration > Save** from the menu. (See [Figure 5.10](#)) This will link the fixture definition with the ID chip on the diagnostic plate by creating a RiFixtureCal object in guru with the "ri.test.Fixture=*Fixture Family*" attribute.

If the process has been completed correctly, the fixture instrument will be automatically added to the configuration window list when the diagnostic plate is docked and a [System Check](#) or [System Startup](#) is performed.

# DIAGNOSTIC PROCEDURE

## SUMMARY

- 1. Overview**
- 2. Before Running Diagnostics**
- 3. Test Instrument Module Diagnostics**
- 4. TIM-Specific Diagnostic Instructions**
- 5. System Controller (EPC) Diagnostics**

---

**Read all instructions and procedures in this section before running diagnostics on a Cassini ATE system.**

---

## OVERVIEW

This section outlines the methods and procedures for conducting diagnostics on a Cassini ATE system in accordance with factory recommended practices. Diagnostics can be performed on demand to validate the operation of the instruments for acceptance or to identify a problem or issue with a TIM that is not operating within specifications or suspected of damage. Typically, diagnostics of the complete test system are performed before a calibration to insure that all TIMs are functionally operational and can produce repeatable results. A comprehensive diagnostic test of the Cassini ATE system includes:

- A test and verification of the RIFL communication link between the test system's test head and installed TIMs
- Low-level tests of instruments with reference oscillators to verify drive levels and frequency lock.
- Diagnostic test plans that exercise the internal components of the instruments and perform various measurements to validate that the TIMs are functionally operational and produce repeatable results.

## BEFORE RUNNING DIAGNOSTICS

Before running diagnostics the following procedures should be followed:

---

**The test system and all TIMs must be powered on and allowed to warm-up at least 20 minutes before running diagnostics to allow instruments to reach a stable operating temperature. Diagnostic test results are not valid within the warm-up period.**

---

1. Login to the test system with user credentials that have a “Maintenance” user role and are authorized to perform diagnostics.

*NOTE: The user account can be logged out and logged in while the active shortcut and applications continue to run. Open applications will adapt their menu access controls to the user account that is activated.*

2. Verify that the latest shortcut for performing diagnostics is active. Reference [Shortcuts & Software Patches](#) in Chapter 1 for more information.
3. Open the [Configuration Window](#).
4. Remove any physical fixtures and/or device interfaces from the test head.
5. Remove any fixture and/or DIB software definitions from the system configuration list by performing a [System Check](#) or Right

Mouse Button (RMB) click the fixture and/or DIB definition in the Configuration Window, and select **Remove** from the pop-up menu, and then select **OK** to confirm as shown in [Figure 5.13](#).

6. Inspect TIM interface surfaces and connectors to insure they are free of damage, wear, and/or debris. Reference [Figure 3.4](#), [Figure 3.5](#), and [Figure 3.6](#) for more information on inspecting and cleaning RF connectors.
7. Place the Diagnostic/Calibration Plate on the test head and verify that the physical TIM layout matches the location of the TIM interface block locations on the Diagnostic/Calibration Plate.
8. Verify that the instrument names and test head slot locations in the Configuration Window match the corresponding interface block locations on the Diagnostic/Calibration Plate.

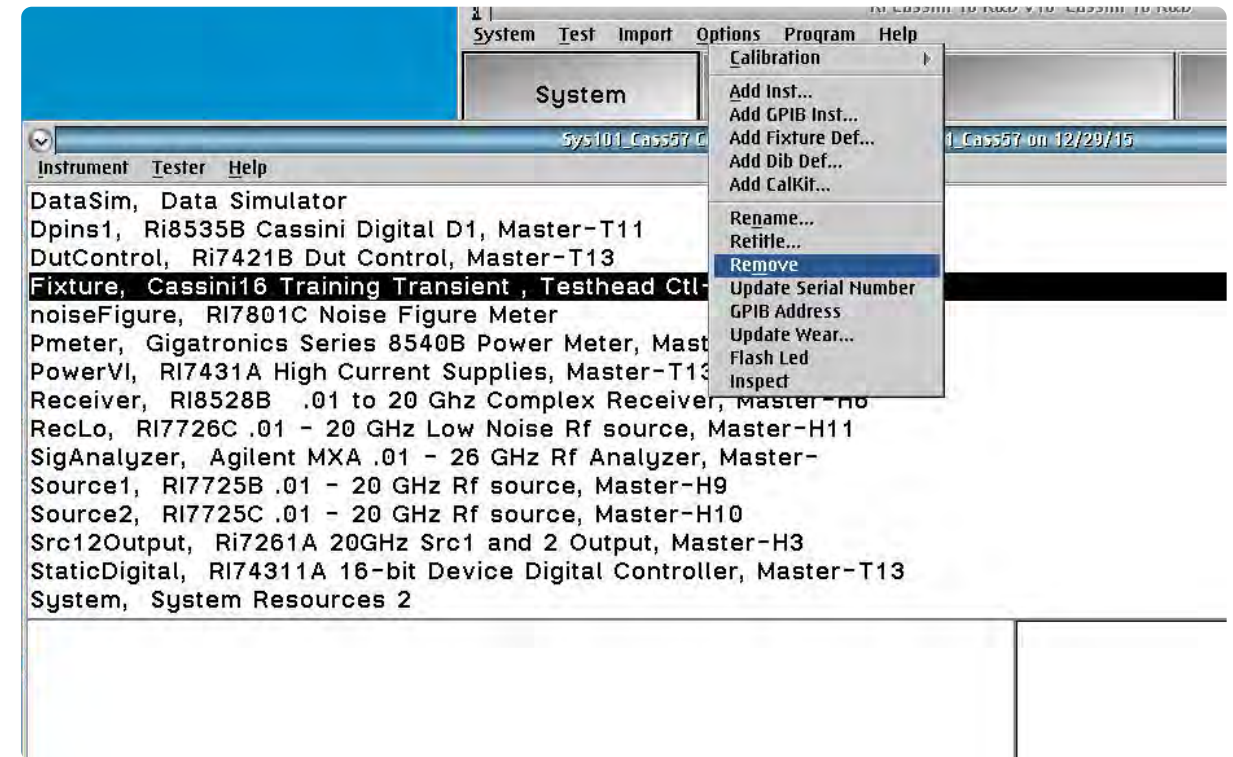
*NOTE: In the Configuration window, the test head slot of an instrument is designated at the end of the instrument name by the suffix ‘-T’ and then a number. For example ‘-T11’ designates test head slot 11.*

9. [Dock the Calibration/Diagnostic Plate](#) to the test head and perform a [System Check](#) to add the fixture software definition to the system configuration. Confirm that the fixture was added to the Tester Configuration window.
10. [Open the Message Window](#) and clear the console field by selecting the **Clear** button at the bottom of the window.



11. Perform a [RIFL Test](#) to verify communication between the test head and installed TIMs (reference the [Equipment Pool](#) section of Chapter 1 for more information on the RIFL Test):  
From the equipment pool, RMB click on 'Master' at the top of the node list and select 'RIFL test' from the menu. In the pop-up window select OK to confirm a value of 1 in the repeat for a single run.
12. Confirm that all communication and loopback tests between the TIMs and test head hubs pass, i.e. - no failures in the Message Window console.

FIGURE 5.13 REMOVING A FIXTURE SOFTWARE DEFINITION



A fixture's software definition can be removed from the system configuration by right-clicking on it to highlight it, and selecting 'Remove' from the menu.



## TEST INSTRUMENT MODULE DIAGNOSTICS

If all checks and tests from the previous section are satisfied, diagnostics can be performed on the test system's TIMs. The test system's primary instrument diagnostics can be accessed from the Configuration Window by selecting **Tester > Diagnose** from the menu options as shown in [Figure 5.2](#) of the User Interface section. This launches the [Diagnostic Executive](#) and loads the factory-installed diagnostic test plans for the test system (see [Figure 5.14](#)). The diagnostic tests are listed in order of ascending instrument number and grouped by TIM.

*NOTE: This diagnostic list may vary between Cassini ATE systems with different TIM configurations. Diagnostic test plans for TIMs not currently installed in the test system can be viewed in the diagnostic list, but attempting to execute them can cause system errors.*

### **Execute Self Test**

The Self Test is a low-level diagnostic check for TIMs that contain reference oscillators. The self test measures and checks the reference drive levels and corresponding frequency values of these instruments.

1. From the Diagnostic Exec's menu options select **Run > Self Test**
2. Diagnostic results and measured data will be displayed in the [Messages Window](#).

### **Execute All Diagnostics (Complete System Diagnostics)**

*This is the recommended method for performing diagnostics prior to an annual calibration of the test system or when releasing a test system to production.*

This option automatically compiles and executes every TIM diagnostic test sequentially, in the order they are listed in the executive window.

1. From the Diagnostic Exec's menu options select **Run > All**. Reference [Figure 5.14](#).
2. Diagnostic tests will be individually compiled and executed sequentially until all diagnostic tests are completed.
3. During compile of a diagnostic test, a pop-up status bar window will display progress and then close when the test program executes.
4. Diagnostic results will be displayed in the 'Results' pane of the Diagnostic Executive. See the [Viewing Diagnostic Results](#) for more information.

*NOTE: In this execution mode, all diagnostic tests in the list will be executed uninterrupted until completion. To abort the system diagnostics hold down the CTRL key and press the Pause/Break key to force an abort. An 'Error:Control Break' window will pop-up. Select 'Abort' to stop the diagnostics.*

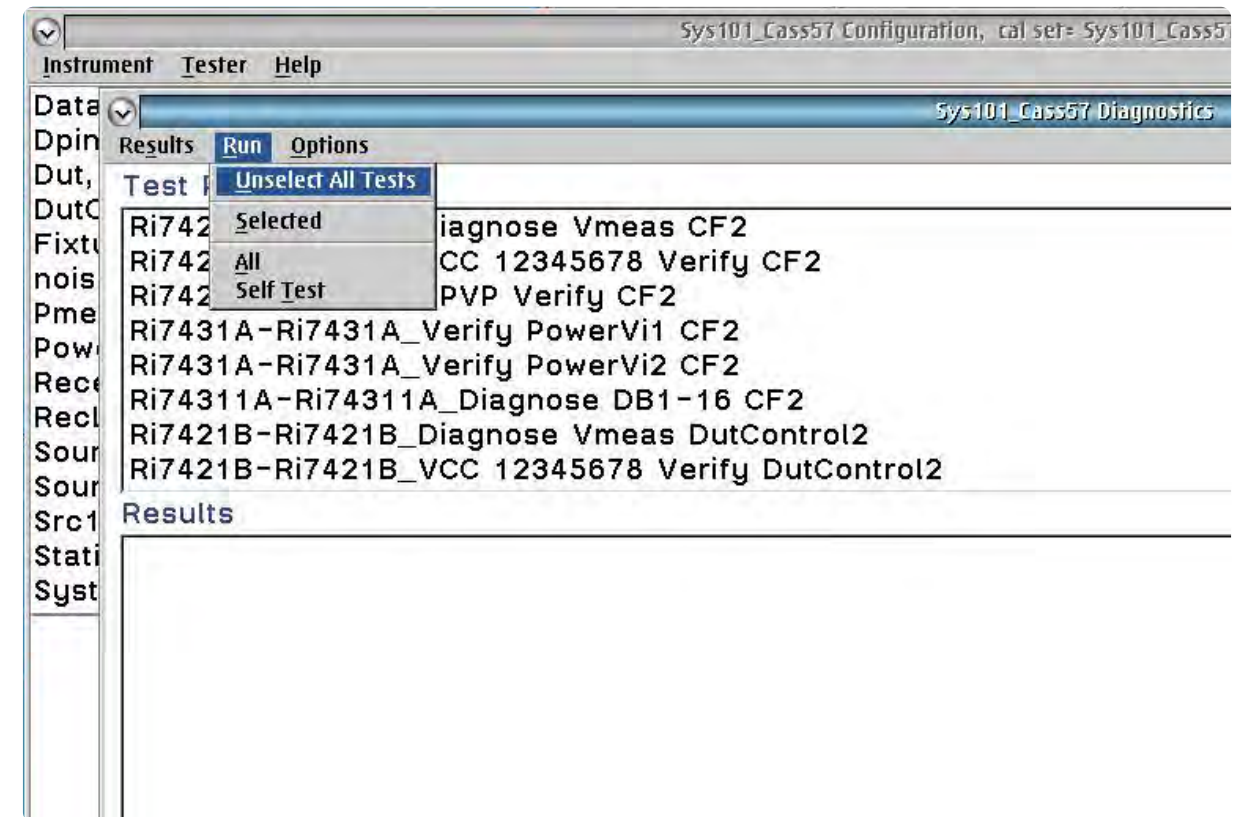
## Execute Individual Diagnostic Test (User Selection)

*This is the recommended method for evaluating the operation of an individual TIM.*

Individual diagnostic tests can be selected from the list of all test system diagnostics as follows:

1. LMB click the desired diagnostic test from the list to highlight it. This can be repeated to select multiple tests simultaneously. To unselect a highlighted test, LMB click on the highlighted diagnostic test. To unselect all highlighted tests, select **Run > Unselect All Tests**.
2. To execute the highlighted tests, from the menu options select **Run > Selected**. Reference [Figure 5.14](#).
3. During compile of a diagnostic test, a pop-up status bar window will display progress and then close when the test program executes.
4. Diagnostic results will be displayed in the 'Results' field in the lower pane of the executive window. See the [Viewing Diagnostic Results](#) section for more information.

FIGURE 5.14 RUNNING DIAGNOSTIC TESTS



Diagnostic tests are executed from the Run menu option as shown above. All tests can be run by selecting the 'All' option or user-highlighted tests can be executed by choosing the 'Selected' option. As well, all highlighted tests can be unselected by choosing 'Unselect All Tests'.

## Viewing Diagnostic Results

Once a diagnostic test is complete, the text field in the Results section of the Diagnostic Exec will display a pass or fail result for the corresponding test as shown in [Figure 5.16](#). The default result settings will display 'pass' at the end of a passing test. If the test fails, the results will display 'FAILED!' and then provide all measurement data associated with the failed test.

*NOTE: The text field in the 'Results' section of the Diagnostic Exec is cleared before Diagnostic are executed, i.e - when the 'Run' > 'All' or 'Run' > 'Selected' menu options are executed.*

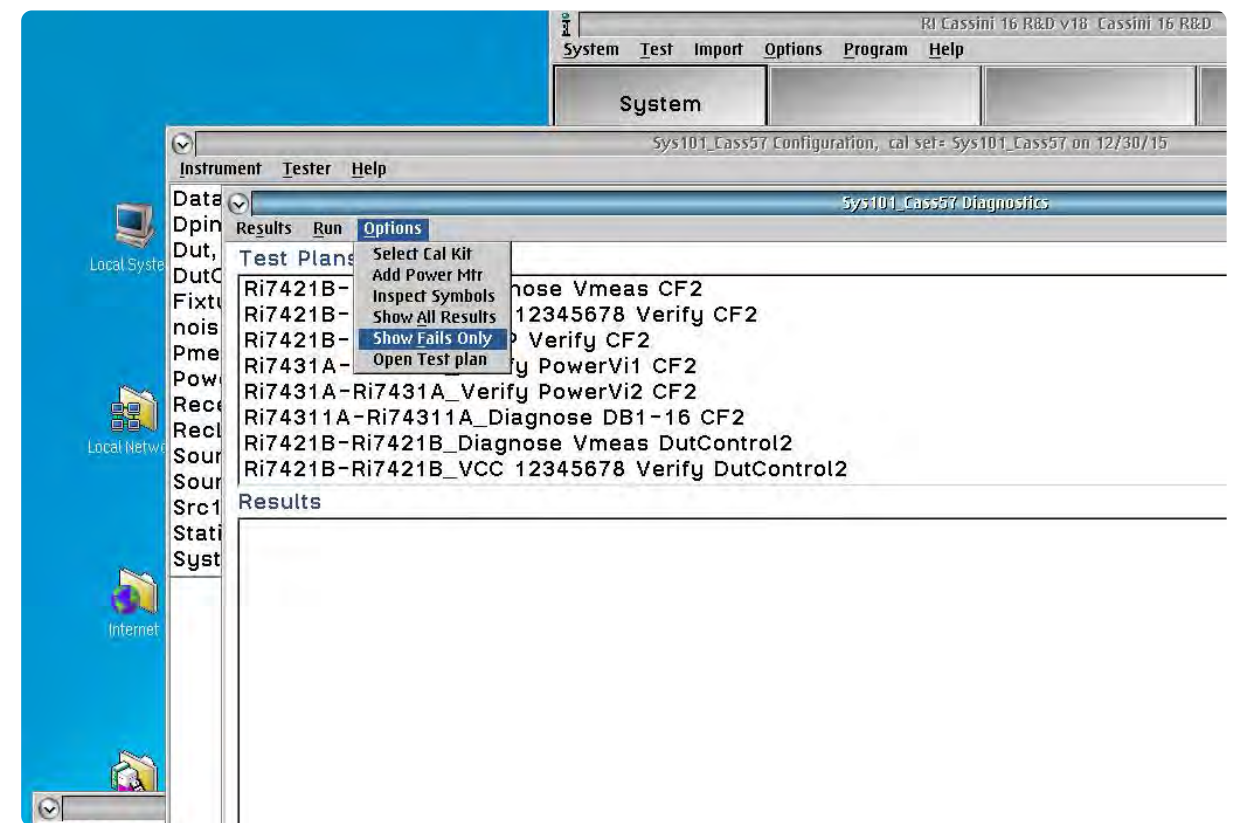
To view all measurement results, i.e. - results from pass and fail diagnostic tests:

1. From the Diagnostic Exec menu options select **Options > Show All Results**.
2. Subsequent diagnostic tests that are executed will display all measured data in the results window for both passing and failing diagnostic tests.

To only view measurement results for failing diagnostic tests (default setting):

1. From the Diagnostic Exec menu options select **Options > Show Fails Only**.
2. Subsequent diagnostic tests that are executed will display measured data in the results window for failing diagnostic tests only.

FIGURE 5.15 RESULTS DISPLAY OPTIONS



Pass/Fail information from diagnostic tests are displayed as text in the Results field of the Diagnostic Exec. Options for displaying all measured data or only failed data (default) can be selected from the 'Options' menu.



## Saving Diagnostic Results

The text field data in the Results can be captured for support or documentation purposes from the Diagnostic Exec. To save the results to a text file(.txt):

1. From the Diagnostic Exec menu options select **Results > Save to File...** as shown in [Figure 5.16](#).
2. A Save File window will pop-up, allowing the user to enter a file name and select a file directory in which to store the text file.

---

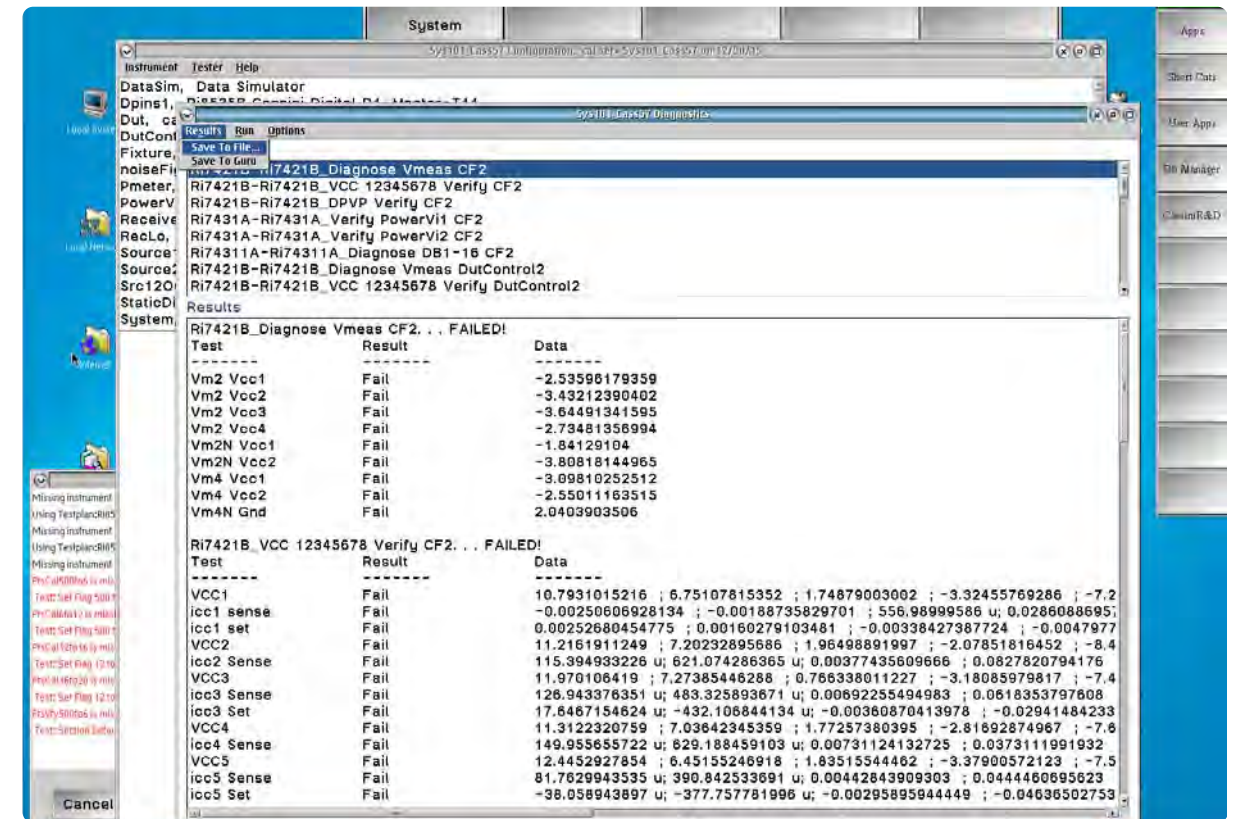
**CAUTION:** Do not save files to the C:/ drive. Save to an RI approved USB drive, networked drive, or to the D:/ drive (temporary option).

---

Alternatively, the text in the Results field can be selected manually:

1. In the Results field, LMB hold and drag the mouse to select the text of interest.
2. RMB click within the highlighted text or hold the CTRL key and press C to copy the text to the clipboard.
3. The text can be pasted into a text file or other program from the clipboard by holding the CTRL key and pressing V to paste.

FIGURE 5.16 SAVING/EXPORTING DIAGNOSTIC RESULTS



Results and measurement data from diagnostic tests can be saved to a .txt file from the Results menu.

## TIM-SPECIFIC DIAGNOSTICS

Some Test Instrument Modules require unique and/or supplemental procedures in addition to those listed in this section. Below are instructions for the specified TIMs:

### RI8589 FetPulser Diagnostic Procedure

The RI8589 requires the use of a [diagnostic interface block](#) in order to perform the diagnostics.

---

**WARNING: Do not connect the FetPulser diagnostic block to the TIM until the RI8589 has been powered up and checked-in to the test system configuration.**

---

To run the RI8589 FetPulser Diagnostics:

1. Once the FetPulser has been powered up and checked into the test system, connected the diagnostic block to the TIMs blind-mate interface. See [Figure 5.17](#).

---

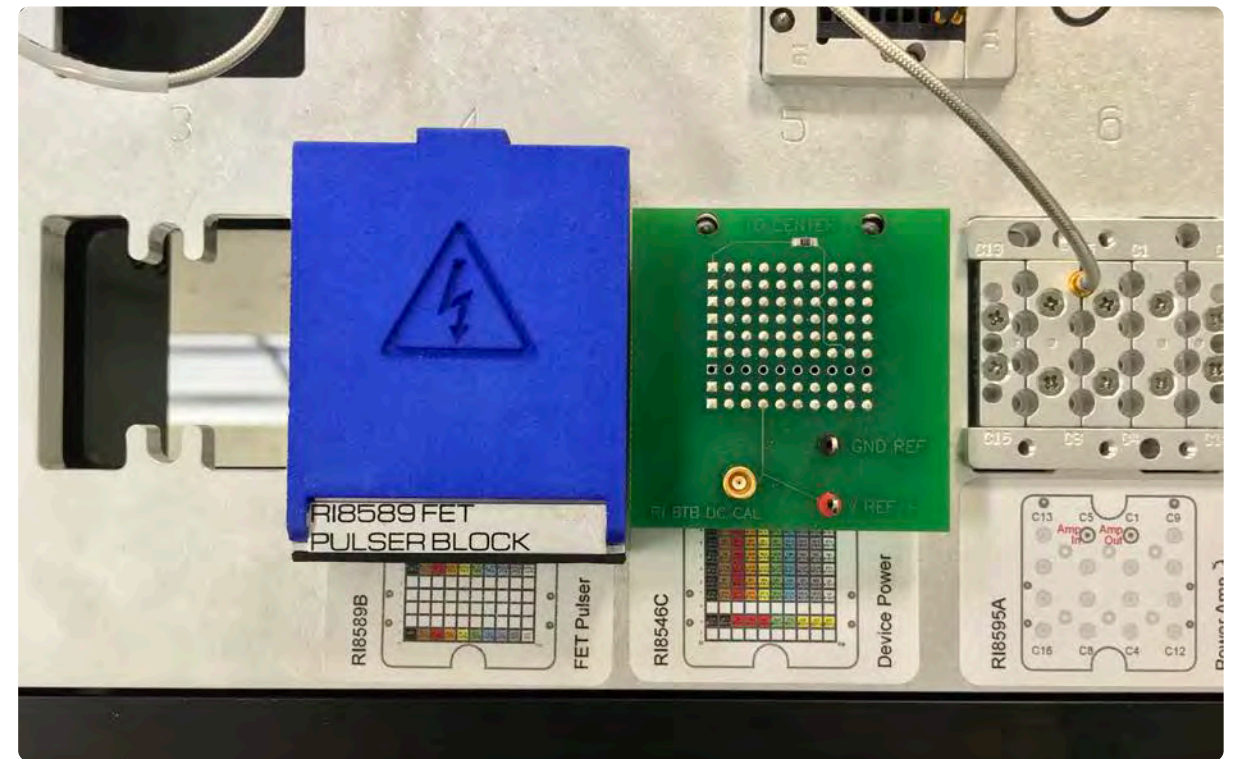
**The interface block must be connected to the TIM prior to compiling/running the diagnostic test plan to insure a Self Calibration occurs with a ground reference provided by the diagnostic block.**

---

2. LMB click on the FetPulser diagnostic test from the list to highlight it.
3. Select **Run > Selected** to execute the highlighted tests, from the menu options. Reference [Figure 5.14](#).

4. During compile of a diagnostic test, a pop-up status bar window will display progress and then close when the test program executes.
5. Diagnostic results will be displayed in the 'Results' field in the lower pane of the executive window. See the [Viewing Diagnostic Results](#) section for more information.

FIGURE 5.17 FETPULSER DIAGNOSTIC BLOCK CONNECTED



Press the diagnostic block down firmly onto the TIMs blind-mate interface to engage all hypertronics pins.

## SYSTEM CONTROLLER(EPC) DIAGNOSTICS

The RI8574 System Controller TIM contains a disk drive, either solid-state or a hard-disk, which hosts the Cassini's operating system and test software. The system controller diagnostics use the Operating System's S.M.A.R.T. (Self-Monitoring, Analysis and Reporting Technology) monitoring system to detect and report on various indicators of reliability of the installed computer disk drives. This diagnostic test can be performed independently from the instrument diagnostics.

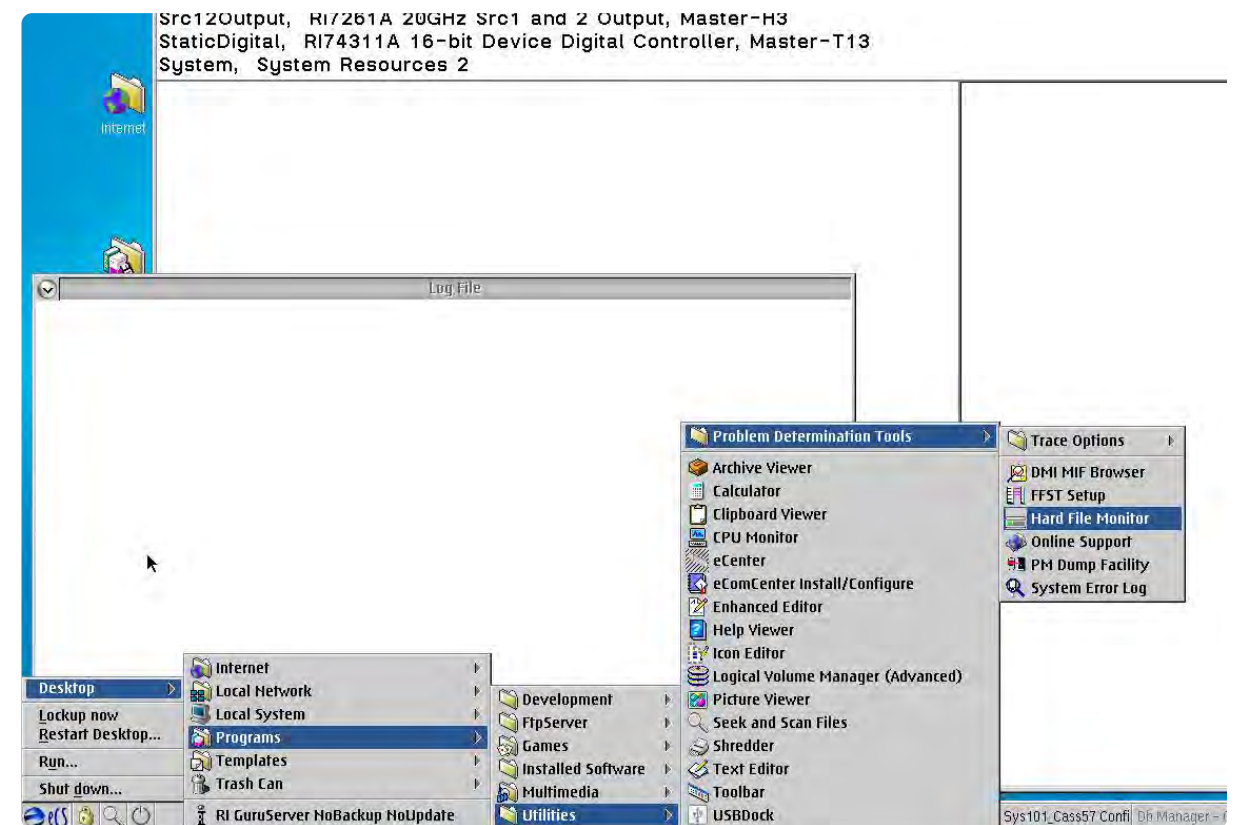
*NOTE: System Controller (EPC) Diagnostic is not a prerequisite for Calibration.*

To run the system controller diagnostics:

1. From the eCS Start button select **Desktop > Programs > Utilities > Problem Determination Tools > Hard File Monitor** to launch the utility as shown in [Figure 5.18](#).
2. The Disk File Monitor application shows all connected drives with a disk icon containing a red or green indicator to designate the drive status, reference [Figure 5.19](#):  
Green - indicates that the disk drive is OK.  
Red - indicates that the drive has an issue.
3. Select the drive icon with a LMB click or from the menu options select **Options > Drive Info** for more information such as the Drive Status, Model, and Serial Number.

**If a failure or warning is reported by the S.M.A.R.T. monitor, the disk drive should be replaced to avoid system outage and/or data loss. Contact Roos Instruments support for assistance in replacing the EPC disk drive.**

FIGURE 5.18 ACCESSING DISK DRIVE DIAGNOSTICS



The system controller's disk drive diagnostics can be accessed from the eCS start button menu.



FIGURE 5.19 SYSTEM CONTROLLER (EPC) DRIVE INFORMATION



The Hard File Monitor utility displays the status of disk drive in the System Controller(EPC). To advance to additional drives select 'Next Drive'. To close the Drive Information window select 'Cancel'.

# CALIBRATION

---

**General Reference  
Information for Calibrating  
Cassini Test Systems using  
the Calibration Kit and  
Diagnostic/Calibration  
Interface Plate.**



# CASSINI SYSTEM CALIBRATION

## PLAN FOR CALIBRATION

Calibrations should be scheduled yearly following the [Preventive Maintenance Schedule](#). The frequency can be adapted by the end-user's discretion. Calibrations can be safely postponed up to 6 months time if the system is in a thermally stable environment where the ambient temperature does not vary by more than 5° C.

Months or weeks before a scheduled calibration, check that all the equipment used to calibrate the system are calibrated themselves to the global [NIST electromagnetic standard](#).

Make sure that all calibration standards and instruments in a Cal Kit are in good working order. Look for straight pins, inspect center conductors for wear and clean connectors to remove any debris.

Inspect the Cal Kit definition to assure the item's serial numbers and calibration data are accurate by following the procedure to [Inspect and Modify Cal Standards](#).

Verify that all TIMs are functioning properly before starting the Calibration Procedure by following the [Run All Diagnostics](#) procedure.

*NOTE: Performing a Calibration on a TIM that is failing may cause the Diagnostics to pass even though a component is not functioning up to specifications. ALWAYS Run All Diagnostics prior to following the Calibration procedure.*

The Calibration Procedure can take about 4 to 6 hours for a typical system configuration to complete. Calibrations are interactive so the total time is dependent on the responsiveness of the operator and the model and configuration of TIMs.

Calibration should not be performed on a “cold” system, TIMs require at least 2 hours to stabilize enough to calibrate.

## PREPARE FOR CALIBRATION

Use the following procedure to prepare the system for calibration:

1. If the Cassini main system window is not already open, turn on the system's main power and monitor.

---

*CAUTION: The system must be running for a minimum of 2 hours before starting this Calibration procedure. This warm-up time is required for the instruments' internal temperature to stabilize and minimize the affects on the Calibration data.*

---

2. If another user is already logged in, choose **System > Logout** from the Guru bar to change privileges. Select **Login** from the Guru control bar and log in as a user with "Maintenance" permissions.

*Note: The user can safely log out and log on while Guru Apps continue to run.*

3. If the Cassini main system window is not already open, select the appropriate shortcut from the **Short Cuts** button on the Guru control bar to open the Cassini main system window. If the RI Message Window displays an Error or Warning message, please correct the problem before continuing.
4. If a Fixture is attached, [unlatch and remove from the test head](#).
5. If not already completed, follow the [Run All Diagnostics](#) procedure to verify that all TIMs are functioning properly. DO NOT continue with calibration if any TIMs fail diagnostics.

6. Choose **System > Tester** from the Cassini main system window to open the configuration window.

## ACTIVATE THE CALIBRATION COMPONENTS

The Diagnostic/Calibration (Diagnostic/Calibration) interface plate, Calibration Kit (Cal Kit), and Power Meter must be loaded into the configuration before the [Calibration Procedure](#) can be followed.

Dock and activate the Diagnostic/Calibration interface plate:

1. Before connecting the Diagnostic/Calibration interface plate to the testhead, visually inspect the fixture and test head connectors. Do not attach if any damaged pins are found.
2. Use the orientation arrow and four guide pins in the testhead to align the Diagnostic/Calibration interface plate with the testhead. Place the Diagnostic/Calibration interface plate downward onto the test head.
3. When the “Align” light turns from red to green, ensure all fingers are clear of the fixture and rotate the fixture switch to “Latch”.
4. Choose **System > Check** from the Cassini main system window to have the system load the Diagnostic/Calibration Interface plate into the system configuration. The item will appear as “*Fixture, <Cal Kit Name> Transient, Fixture Pwr*” in the configuration window.

Attach GPIB Instrument Pod and activate the Power meter:

1. Attach the GPIB Instrument Pod to the RIFL AUX ports on the back of the Testhead. Connect GPIB cable to power meter.

Choose **System > Check** from the Cassini main system window to activate the GPIB Instrument Pod.

*NOTE: If an AUX rack is used with a GPIB Instrument Pod, do NOT attach another GPIB Instrument Pod. Connect the GPIB cable from the power meter to the end of the GPIB cable bus attached to the Pod in the AUX rack.*

2. Select **Instrument > Add Power Mtr** from the configuration window. Alternatively, the Power Meter can be loaded after launching the Cal Exec by choosing **Options > Add Power Mtr**.
3. Accept the default instrument name of 'Pmeter' by pressing **OK**, then accept the GPIB address of 13 by pressing **OK** again. On the power meter, the remote light should flash on, then off. The *Pmeter* instrument should now be visible in the configuration window.

*NOTE: Roos Instruments always sets the power meter to use GPIB address 13. The facility may have a power meter used for calibrations set to a different GPIB address.*

4. Attach the Power Sensor to the Power Meter and connect to the Power Sensor calibration port. Press **Zero/Cal** button on the Power meter and wait for the calibration to finish.

Add the Calibration Kit (Standards) to the configuration:

1. In the Configuration window, select **Instrument > Add cal Kit**. Alternatively, the Cal Kit can be loaded after launching the Cal Exec window by choosing **Options > Select Cal Kit**.
2. Select the appropriate calibration kit and choose **OK**.

*NOTE: For a valid calibration, the calibration kit definition must match the Calibration Standards used in the Cal Kit. See the [Inspect and Modify Cal Standards](#) topic.*

3. The Calibration Kit contains the coefficients for the open/short/load and noise standard calibration components. Contact [support@roos.com](mailto:support@roos.com) for an updated calibration kit definition.
4. The calibration kit should now be in the Configuration window.

Once the Diagnostic/Calibration (Diagnostic/Calibration) interface plate, Calibration Kit (Cal Kit), and Power Meter are visible in the configuration window, continue on to the Calibration Procedure.

## CALIBRATION PROCEDURE

After the Calibration components are loaded, the Calibration Executive window should be opened to begin calibrating the tester. The Calibration Executive window enables the user to run multiple calibration and verification test plans unique to the configuration and layout of TIMs. The Calibration Executive automatically saves the calibration data only if the verification test plan passes. Calibration and Validation plans should ALWAYS be run as a pair. The calibration data is reset (lost) when a Calibration service plan is compiled and the calibration data is only saved after the Validation plan passes.

---

**WARNING: Do not exit the Calibration Executive window after running a Calibration service plan and Validation plan pair. Invalid Cal data may be saved and cause measurements to fail.**

---

1. Open the Calibration Executive window by choosing **Tester > Calibrate** from the configuration window. Alternatively, from the configuration window, highlight the 'System' instrument and choose **Instrument > Calibration > Calibrate**. Highlight the appropriate Cal List and press **OK** to open Calibration Executive window.
2. Select and run calibration and validate service plans in the order listed in the Calibration executive.



*NOTE: The system only saves the Calibration factors after all selected plans have been run, so run only a few plans at a time. With this method, if an operator error occurs and a validate plan fails, then only the selected Calibration plans will have to be run again.*

Run the Calibration and Validation plans in groups of 4 to 6 at a time:

1. Highlight the test plans in groups identified by their instrument name by clicking on the test plan name to select it. Don't select more than 6 plans and don't select a Calibration plan without it's Validation pair.
2. To run the selected tests, select **Run > Selected** from the menu bar.

*NOTE: If the Cal Kit or Power Meter is not active, the Cal Exec will prompt the user to load them. Choose Options > Add Cal Kit and/or Options > Add Pwr Meter to add them to the configuration.*

3. Follow the operator prompts provided by the test system while it runs the calibration plan.
4. Repeat steps 1 through 4 until all of the test plans have been performed. If the validation test plan fails, run the Diagnostic tests for the Instrument that failed.
5. After all instruments have been calibrated, the System Calibration is considered complete.

## CALIBRATION DOCUMENTATION

If Roos Instruments performs the calibration, a "Calibration Certificate" that provides NIST traceable Model and Serial Numbers and "Calibration Sticker" will be sent via standard mail in 3-6 weeks after the calibration is completed. The "Calibration Sticker" should be attached to the system that was calibrated.

Schedule a calibration according to the [Preventive Maintenance Schedule](#), or appropriate frequency.

# CALIBRATION KIT

## CALIBRATION KIT

To calibrate a Cassini system two components are required appropriate for your Infrastructure (8-port or 16-port) and specific configuration of TIMs:

1. An 8-Slot or 16-slot Diagnostic/Calibration Interface (Diagnostic/Calibration) Plate (See [Figure 6.1](#))
2. A Calibration Standards Kit (Cal Kit) rated up to 20 GHz, 40 GHz, or 80 GHz. (See [Figure 6.2](#))

The Diagnostic/Calibration Interface Plate is included with delivery of a new Cassini system and includes the required fixed RF interconnect cables and blind mate blocks for the specific arrangement of TIMs as well as PKZ #12 cables needed to perform the calibration. The Cal/ Diag plate can be used on any similarly configured Cassini system.

The Cal Kit includes a Power Meter and Sensor, Digital Volt meter, S Parameter Standards, Noise standard, Cables, RF Adapters, and RF Attenuators appropriate for either 20 GHz, 40 GHz or 80 GHz calibration.

The instruments and standards in the Cal Kit need to be calibrated regularly to [NIST standards for Electromagnetic Measurements](#). The customer is responsible for setting the duration of the calibration interval and maintaining documentation. The power meter, power sensor, and DMM are typically calibrated annually. The noise standard and OSL standards can be calibrated bi-annually. If available, use a calibration lab (Cal Lab) at your facility or one in your local area. If a Cal Lab is not available or can not calibrate a specific instrument or standard, it may have to be sent to the manufacturer for calibration. RI offers Cal Kit service as RIK0082A for 20 GHz cal kits. RI usually issues a NIST traceable calibration certificate only when a preventive maintenance and calibration (PMC) is performed. A calibration is performed when a major physical instrument is repaired or replaced, but a certificate is not always issued. For many types of TIMs, a full system calibration is not necessary when exchanged, factory Cal is sufficient.

The RI Cal Kit comes with a USB stick with a '.gzp' file containing the Cal Kit definition. The calibration factors (a.k.a. coefficients) are stored in Guru as an "RiCalibrationKit" object class. If the Cal Kit is shipped to other locations, be sure to update the '.gzp' file on the USB stick whenever the Cal standard coefficients change.

*NOTE: Be sure the correct coefficients are imported with Guru Browser prior to using a new Cal Kit.*

FIGURE 6.1 DIAGNOSTIC/CALIBRATION INTERFACE PLATE



Diagnostic/Calibration Interface Plate kit is stored in a black transportable container and includes all required Cal Blocks and interconnections.

FIGURE 6.2 CALIBRATION KIT, 20 GHZ



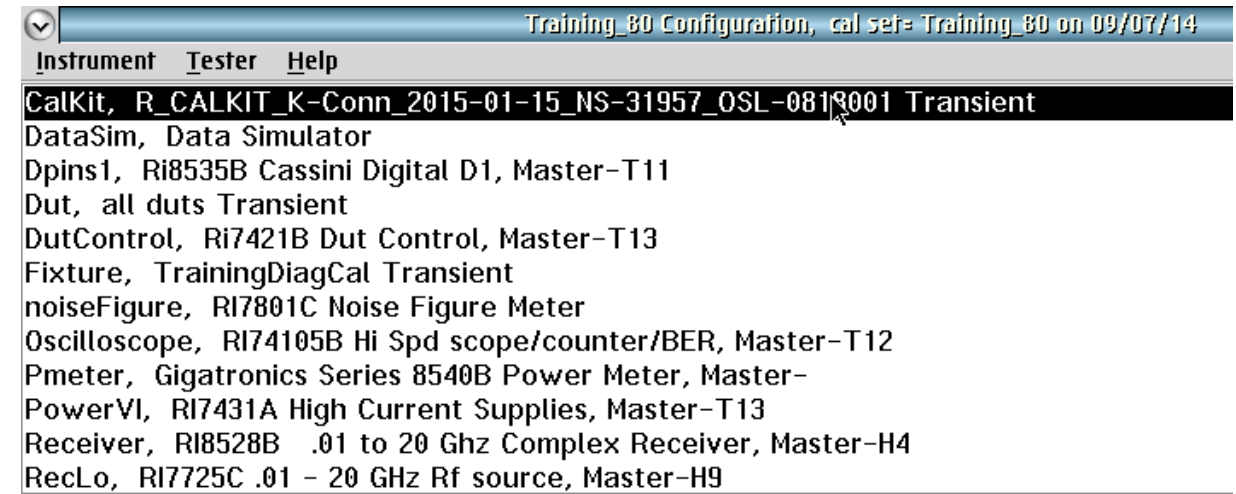
Calibration kit is stored in a black transportable container and includes all required instruments, adapters, and cables.

## ADD CAL KIT TO CONFIGURATION

A Cal Kit must be added to the configuration before being used in the Calibration Procedure or before the calibration factors/coefficients can be updated. (See [Figure 6.3](#))

1. If it is not already running, login as a user that belongs to a group with Maintenance permission and launch Cassini with the latest available Short Cut.
2. When preparing for Cal or inspecting Cal Kit, open the System Configuration window by selecting **System > Tester** from the Cassini main system window. Choose **Instrument > Add CalKit**, then select the appropriate Cal Kit name from the list.
3. Alternatively, when performing a calibration, choose **System > Tester > Calibrate**. From the Calibration Exec window, chose **Options > Select Cal Kit**.

FIGURE 6.3 CAL KIT ADDED TO CONFIGURATION



CalKit entry appears as a Transient instrument in the Configuration window.

## INSPECT AND MODIFY CAL STANDARDS

Periodically, the cal kit coefficients may need to be changed after the Cal Kit Open, Short and Load standards and the Noise Source return from the scheduled calibration at a local Cal Lab.

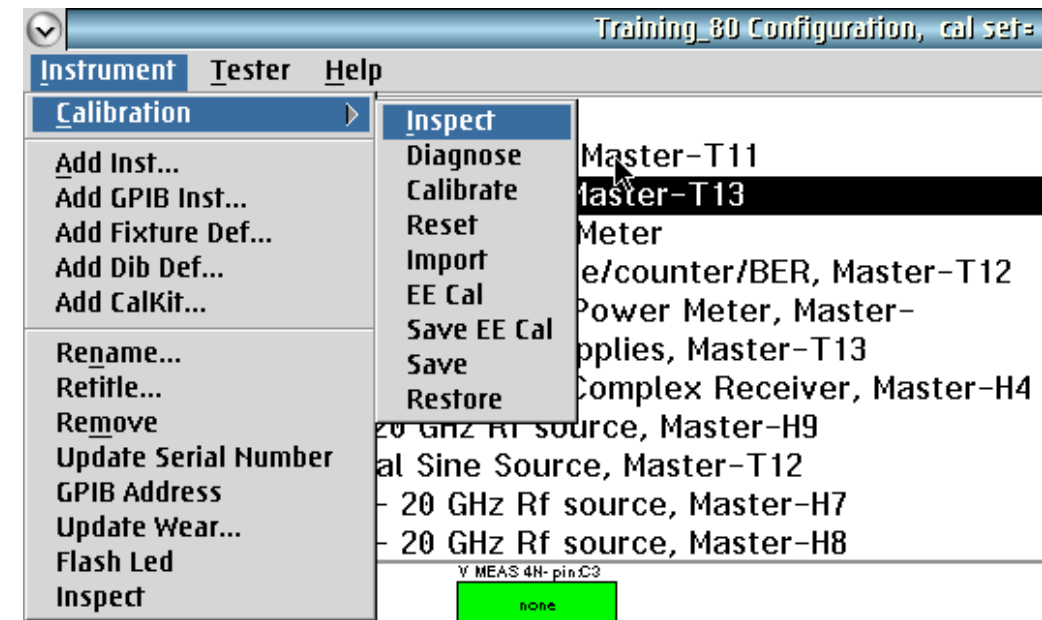
To change the coefficients of a cal kit, use the following procedure:

1. Select the Cal Kit listed in the Configuration window.
2. In the Configuration window select **Instrument > Calibration > Inspect**. Double-click the appropriate element. Entries default to linear values. For logarithmic values, click the **lin** button.

*NOTE: The lin/log button shows the current format, not the desired format. When displaying in linear format, the button shows 'lin'. Clicking on the button changes to log format, and the button changes to 'log.'*

3. To change the coefficients for the Open, double click "open". You will see coefficient values for 'C0', 'C1', 'C2', and 'C3' in "e" notation. Verify that these match the corresponding coefficients from Open standard. If not, change them directly in the text entry field on the right. Verify that the serial number in 'sn' matches the file's serial number and matches the serial number of the actual open. If not, change it.
4. For the Load and Short standards, the only thing to change is the serial number. Double-click on 'load'. Highlight 'sn'. Verify that it matches the serial number of the actual load. If not, change it so it

FIGURE 6.4 INSPECT CAL DATA FROM CONFIGURATION WINDOW



### Changing the Cal Kit coefficients

matches. Repeat this for the Short. After making any changes right click on the CalKit instrument and choose **Calibration > Save**.

5. Changing the Noise Source coefficients, Double-click on 'enrTable', then double-click on 'enr'.

There are normally 20 coefficients, corresponding to the 20 values on the noise source's label. Highlight '1'. Verify that the frequency is '10' (corresponding to the 10 MHz coefficient on the noise source's label).

Select 'Power'. Note that the power displayed is a log number.



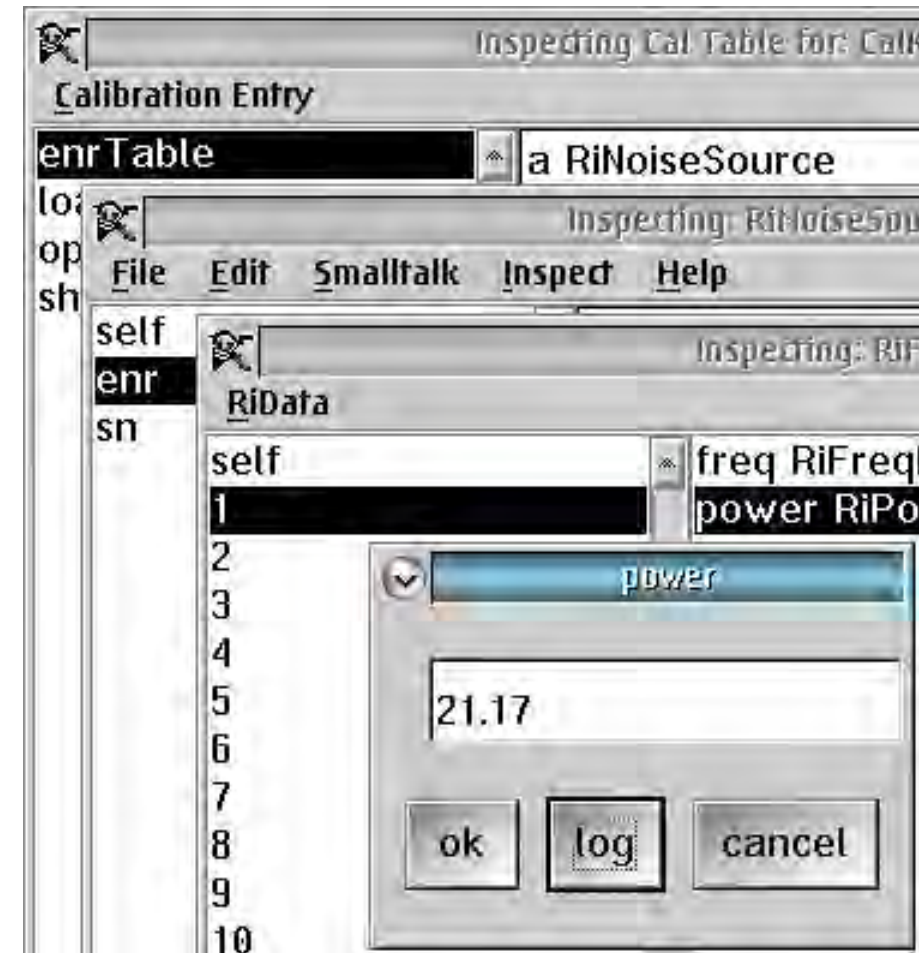
Change it to linear by selecting 'lin'. Confirm that this number exactly matches the coefficient on the noise source's label. If not, change it and select 'OK'.

Repeat this process for ALL the other coefficients, then close this panel.

Verify that the serial number in 'sn' matches the serial number of the noise source. If not, change it.

6. Close the panels. If the user has changed anything, right click on the CalKit instrument, select **Calibration > Save**.
7. If the Cal Kit is shipped to other locations, export the Cal Kit with Guru Browser. Set ri.sys.ObjectClass to "RiCalibrationKit", then select and export (Right click, export Guru format) the most recently updated entry. Copy this .gzp to the USB stick included with the Cal Kit and/or email it to the other location.

FIGURE 6.5 INSPECT/MODIFY NOISE SOURCE COEFFICIENTS



Window sequence for changing the cal kit coefficients.



# TROUBLESHOOTING

---



Procedures for resolving problems with Cassini:

- System Debug Procedure
- Breakpoint and Control
- System Error Log
- Software Error Recovery
- EPC Errors and Recovery
- Guru Errors and Recovery
- Infrastructure Issues
- Test Head Issues
- Handler/Prober Issues

# SYSTEM DEBUG PROCEDURE

This general procedure is to be used to diagnose and communicate system problems. Always carefully inspect each connection layer to rule out physical debris or missed connection. The 9 layers include: DUT, Socket, DIB, Fixture, TIM, Test Head, Infrastructure, Handler/Prober, Facility.

Most common problems are often related to improper docking. These can be quickly solved by inspecting Equipment Pool and removing then re-attaching a missing component. Always choose **System > Check** from the Cassini main system window when removing or adding each piece of equipment. This causes the system to inspect all components, identify them and load their software definitions and calibration data. Choose **System > Equip > Nodes** to view the Equipment Pool that shows the TIMs connected to the test head (T-ports) and AUX RIFL ports (H-ports).

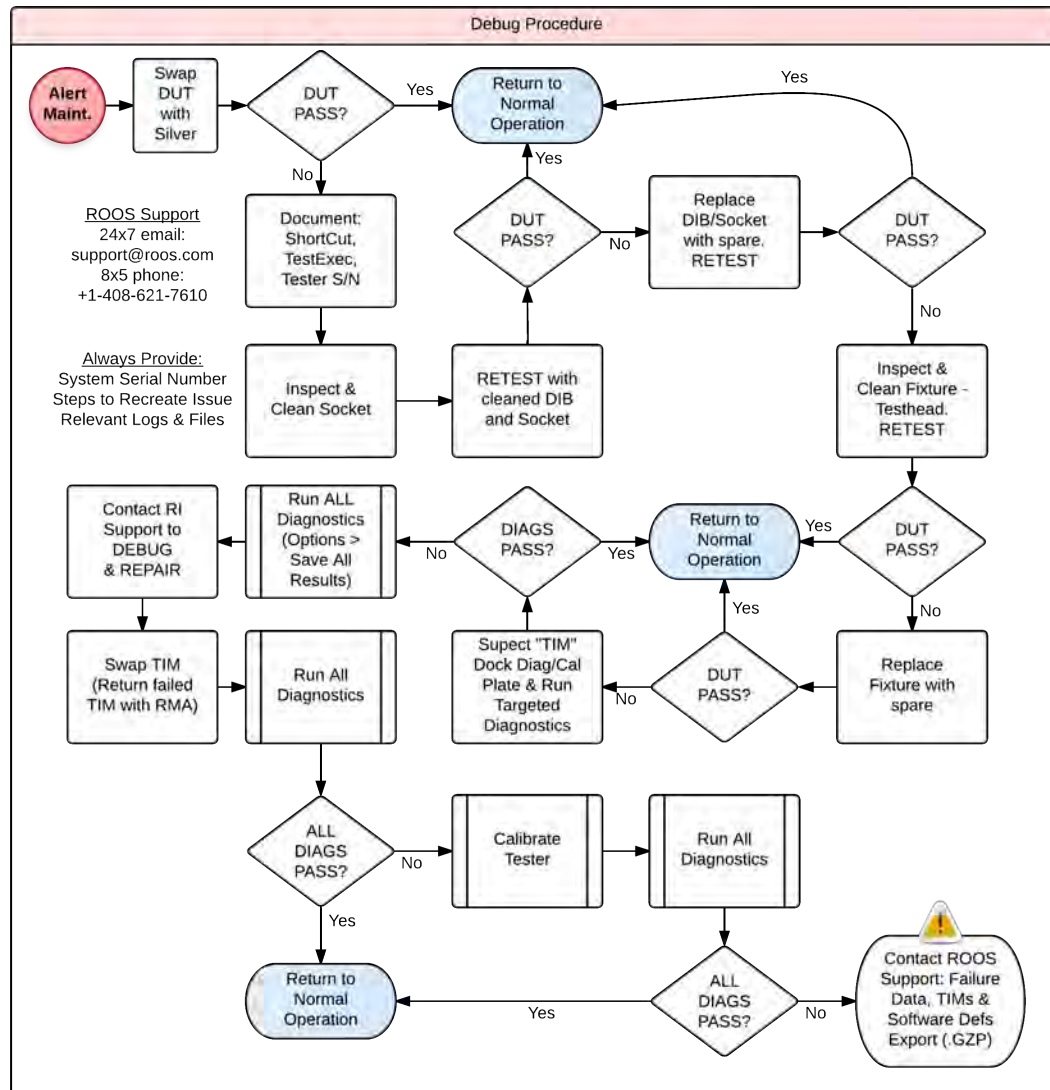
To reduce production down time, RI recommends having at least one spare DIB (Quick-Lock™), Fixture and each model TIM on site to exchange. If a failure is identified, swap the DIB, Fixture or TIM to quickly return to production testing with minimal downtime.

Problems with the DUT and Socket should be reported internally and provided to RI upon request. Please report all problems beyond the DIB layer (including Fixture) to Roos Instruments support ([support@roos.com](mailto:support@roos.com)), even if they are resolved in the field.

## DEBUG PROCEDURE OVERVIEW

1. Confirm DUT FAIL with known good part (a.k.a. “Silver DUT”).
2. Collect information: Test Exec name (DUT), ShortCut name and version, Serial Number of System (Guru ID).
3. Inspect each of the 8 layers, fixing common issues: DUT, Socket, DIB, Fixture, Test Head, TIM, Infrastructure, Handler. If an issue is not identified, continue on to step 3.
4. Follow [Diagnose Procedure](#) to identify faulty TIM(s) with Diagnostic/Calibration interface plate. (See [Interactive 5.1](#)) If not faults are found, repeat step 2.
5. If TIM failure is identified, return to Roos Instruments for repair. Contact RI Support for a RMA, include problem description, all Diagnostic data, and serial numbers of the system (GuruID) and TIM.
6. Replace failed TIM, perform Targeted Diagnostic Procedure.
7. If Diagnostic Procedure fails, RF System Calibration is required.
8. After Calibration, after Diagnostic Procedure completes without a FAIL, release to production.

FIGURE 7.1 DEBUG PROCEDURE DIAGRAM



This procedural diagram should be followed to Debug problems on Cassini. Inspect or replace each of the 9 layers: DUT, Socket, DIB, Fixture, TIM, Test Head, Infrastructure, Handler/Prober, Facility.

System failures are normally suspected when DUT Yields drop below a normal failure rate (i.e. 5% failure). If 100% of the DUTs are failing, the problem could be with the DUT (unlikely) or with the System. Before removing the Fixture and preparing for the Diagnostic Procedure, visually inspecting the DUT, Socket, DIB and Fixture can solve many problems not associated with a TIM Failure. The Diagnostic Procedure should then be followed to identify and replace failed TIMs.

### DUT INSPECTION

- Confirm ShortCut, Exec, DIB and Fixture appropriate for DUT
- DUT Issue, Use “Known Good” DUT (Silver or Gold part)

Confirm that the proper ShortCut and Test Exec is chosen for the active DUT, DIB and Fixture. ShortCut label is displayed in the title of Cassini’s main system window. Test Exec is chosen by the operator. DIB and Fixture are designed to work with a specific DUT or family of DUTs. If the model DIB is designed for another DUT, swap out the Quick-Lock™ system with the correct DIB model. If all appears correct, continue with Socket Inspection.

Manufacturing defects could cause the DUT to fail in such a way that it appears that the Socket or Fixture is failing. Always verify with a known good DUT that the problem is isolated to the tester, and not a problem with the DUT or Socket. Replace the DUT with a known good DUT and run the Test Exec again. If the part passes, then continue testing. If the part fails, continue with DUT inspection.

## SOCKET INSPECTION

- Visually Inspect for Contamination, Clean Socket
- Sockets Have a Limited Lifetime, Repair Socket Pins
- Follow Manufacturer's Guidelines

Always visually inspect the DUT socket(s) connectors before docking the Fixture to the Handler, looking for damaged pins or contamination (dust or debris).

Each socket has a limited number of insertions and pins may be damaged by debris or Handler failures. Repair socket pins according to manufacturer's procedure.

---

***CAUTION:** Always follow the socket manufacturer's recommended guidelines for cleaning sockets and repairing pins.*

---

## DUT INTERFACE BOARD (DIB) INSPECTION

- Quick-Lock™ system: DUT Clamp, Pedestal Support & Pedestal
- Serialized DIB Identification, Test Exec Warning
- Swap with Spare DIB (if available)

The Quick-Lock™ system is used to quickly swap DIB boards to repair socket pins or change parts. Issues may be caused by using the wrong DIB for the DUT, improper DIB orientation, connection contamination, or a misidentified DIB serial number. Always visually inspect the DIB pads used for RF and DC connections before loading the DIB on the Fixture, looking for damaged pins or contamination (dust or debris).

A Test Exec Warning will appear if a DUT definition is not found. Either the serial number chip has been disconnected or damaged or it has not yet been associated with the DIB Calibration data. The DIB has a serialized chip connected to the "S/N" and "Ground" pins of the FIX block that is used to locate DIB Calibration data that matches the ID. Carefully inspect the DIB serial number chip for damage or follow the procedure for Calibrating a DIB. If available, swap with a spare DIB. If the DUT still fails, inspect the Fixture.

When changing DIBs, from the Cassini main system window, select **System > Check** to automatically identify devices that have been removed and devices that are now available. When properly loaded, the DIB will appear in the **System > Tester** configuration view.

## FIXTURE INSPECTION

- Serialized Fixture Identification, Test Exec Warning
- Blind-mate Interface Connections (FIX, RF, DC, and Digital)
- Swap with Spare Fixture (If available)

---

**WARNING: Never latch a Fixture with damaged or contaminated (dust or debris) blind-mate interface blocks. It can damage the TIM or Test Head and propagate damaged pins to other Fixtures.**

---

Like DIBs, Fixtures also have a unique serial ID chip on the carrier board or attached directly to the “S/N” and “Ground” pins on the FIX block. The RI System Software reads this ID on system Startup and will attempt to locate Fixture Calibration data and definition that matches that ID.

A Test Exec Warning will appear if the proper Fixture and DIB are not identified. Either the ID chip is not connected properly or it is not yet associated with Fixture Calibration data. Carefully inspect the DIB serial number chip for damage or follow the procedure for Calibrating a DIB.

If available, swap with a spare Fixture. If the DUT still fails, continue by inspecting the TIMs.

When changing Fixtures, from the Cassini main system window, select **System > Check** to scan the devices. When properly loaded, the Fixture will appear in the **System > Tester** configuration view.

## TIM INSPECTION

- Unidentified TIMs, Latching Issues
- Damaged Blocks, Fixture Plate Compatibility
- Diagnostic Failures

When properly loaded, all TIMs will appear in the Equipment Pool window (**System > Equip > Nodes**) in the appropriate T-location (i.e. T8). Confirm that the TIM is properly latched and fan is on. If TIM is not loaded, follow the procedure to [Install & Remove TIM](#). When changing TIMs, from the Cassini main system window, select **System > Check** to scan the devices. If all TIMs are present in the Equipment pool, continue with a visual inspection of the TIM blocks.

Visually inspect the TIM's blind-mate interface blocks, looking for damaged pins or contamination (dust or debris). If a TIM has a damaged blind-mate interface block, remove the TIM immediately and contact Roos Instruments support for a replacement and identify all Fixtures and inspect and replace any damaged blocks. If all TIM blocks look correct, continue on Test Head Inspection.

After inspecting the previous 4 layers and ruling out common problems, follow the [Diagnose Procedure](#) to identify a failing TIM. Continue on with Test Head inspection if TIMs are not loaded properly or another issue (like Handler communications) is affecting production.

*NOTE: Use the correct Diagnostic/Calibration interface plate appropriate for the current configuration of TIMs when following the Diagnose Procedure.*



## TEST HEAD INSPECTION

- RIFL Communications (Hub)
- Fixture Latching (Pressurized Air)

If TIMs still do not appear in the Equipment Pool (**System > Equip > Nodes**), a RIFL top board may have failed. Test Head issues are often misdiagnosed as a TIM RIFL communication issue. Use the [RIFL Troubleshooting](#) topic to validate RIFL communications between the internal hub and the TIM. All TIMs should be installed in proper location. If a RIFL self test fails, contact Roos Instruments support and follow the procedure to replace the appropriate Test Head top board.

If a Test Head TIM slot is suspected as failing, move the TIM to another location and choose **System > Check**, then confirm the TIM is visible in the newly configured location. If the TIM appears in the new location but not the original location, the problem is with the Test Head top board, contact Roos Instruments support and replace. If the TIM still does not appear, the TIM should be replaced.

If the Fixture latch mechanism is slow or can not successfully latch a Fixture, inspect both the Infrastructure air connection and Facility's Air pressure. If not a facility problem, notify Roos Instruments support and work around issue by manually latching Fixture by pushing on the black Fixture latch plate.

Continue on to inspect the Infrastructure for issues before following the Diagnostic Procedure.

## INFRASTRUCTURE INSPECTION

- Air or Power Supplies
- System Controller EPC
- Touchscreen UI

Infrastructure supplies Air and Power to the Test Head and holds the System Controller EPC. The compressed air source should not be leaking. Replace facility compressed air NTP connector if a leak is detected. The redundant power supplies are accessed from the Power Supply Access panel. Each power supply has a green light when functioning properly. Contact Roos Instruments support if a power supply failure is detected.

The System Controller EPC failures may be more subtle. The System Controller includes the RIFL Master that sets the system's 10 MHz reference clock. See [System Errors and Recovery](#) for more details. If a System Controller has failed, follow the [System Controller Install](#) instructions.

Touchscreen UI (Ergotron adjustable arm, ELO Touchscreen, Keyboard) can be replaced when any UI component fails. Contact Roos Instruments support for RMA and instructions for repair.

Continue on to the Handler/Prober inspection to rule out problems with the handler.



## HANDLER/PROBER INSPECTION

- RIFL III to RIFL II Cable (Handler Pod)
- Handler Pod programming
- Grounding cable

Once configured, handler Pod and cables should not need to be replaced. The most common failure is a damaged RIFL III (H-port) to RIFL II (RJ45) cable. Visually inspect the cable for damage caused by rolling equipment, kinks, or broken insulation. The RIFL cable requires a shielded ground connection. Contact Roos Instruments support for a replacement cable and RMA number.

---

**CAUTION:** *Proper ground is important for reliable communications with the connected handler or prober. A grounding cable should be securely fastened to the Handler/Prober.*

---

Handler Pods are programmed once for a particular model and configuration of handler. All communication is handled by the Test Exec settings and are not intended for user modification. If a handler Pod is suspected of failing, contact Roos Instruments support for a replacement. Some Pods are opto-isolated and require a solid ground connection on the handler side to function properly.

Continue on to the Facility inspection process to rule out grounding, AC power or air pressure issues.

## FACILITY INSPECTION

- AC Power, Ground
- Pressurized Air (Cassini 16 only)

The facility is required to provide a stable 120/220 AC power with reliable ground. Try to use the same breaker panel as the Handler/Prober to reduce grounding issues that may affect communication.

Pressurized air should meet minimum requirements according to [Site Preparation](#) guidelines.

Now that all easily identifiable problems are ruled out, continue on the [Diagnose Procedure](#) to isolate the failed TIM.

# EXPORT SIMULATION

The export simulation feature is a useful tool to capture multiple software elements of an active test system configuration or Cassini simulation environment when troubleshooting an issue. Often times when running a test plan or measurement on the test system, the user has multiple software objects active:

- Fixture, DIB, and Device Control Definitions
- Instrument configuration
- Calibration layers
- Test plan

The export simulation feature allows the user to capture all of these software objects into a single object called an RiSimulationDef. The RiSimulationDef can be exported and emailed to Roos Instruments support to re-create the exact test system configuration and software environment settings when assisting with application support and/or troubleshooting.

*Note: The ShortCut is not included in the manifest. Please include the Title of the Short cut with the description of the problem.*

To export a simulation of an active test system or simulator:

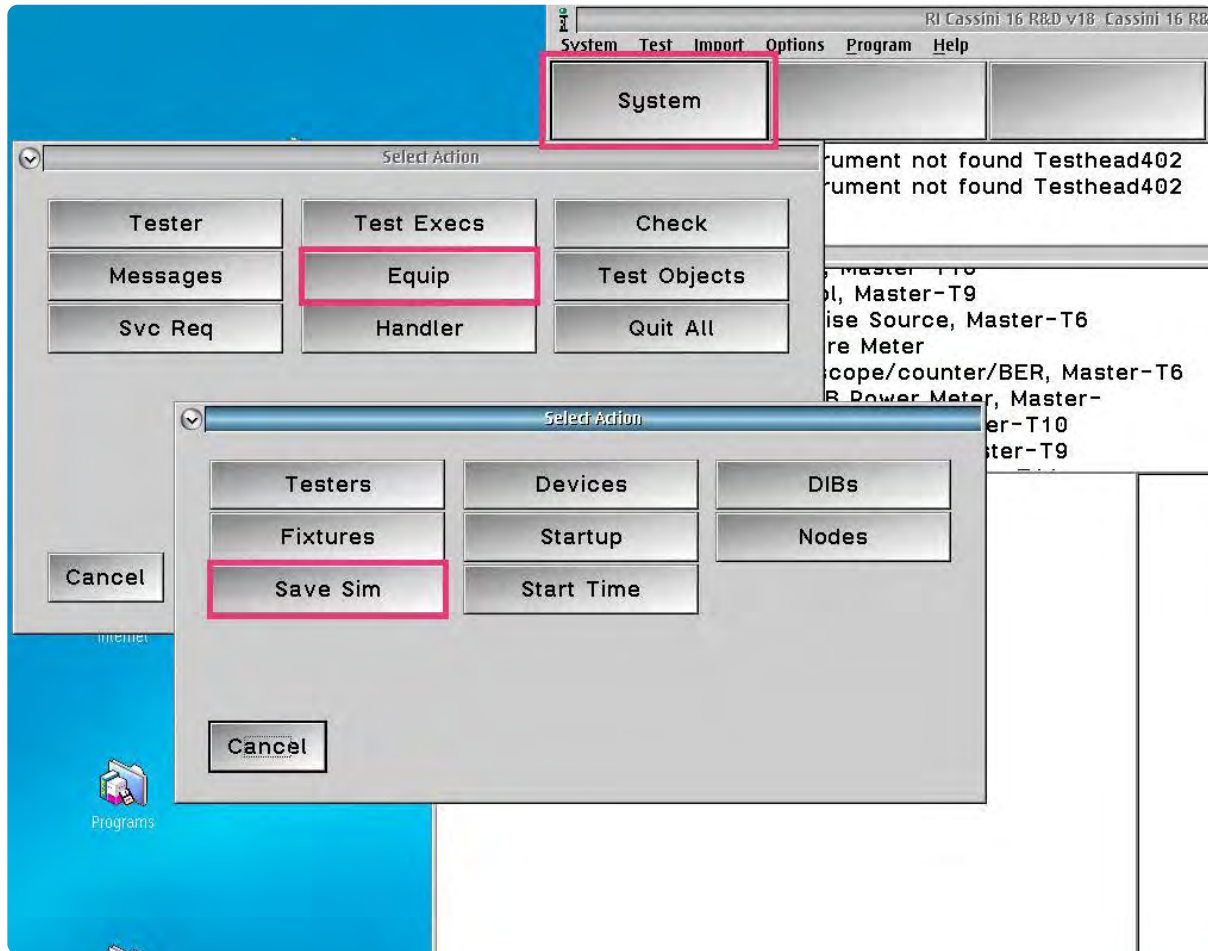
1. From the Main System Window select **System > Equip > Save Sim** as shown in [Figure 7.2](#).
2. To access the SimulationDef Object, open a Guru Browser window. Reference [Figure 1.68](#) for accessing and launching Guru Browser.
3. Leave the 'Key1' field set to 'ri.sys.ObjClass' and choose 'RiSimulationDef' from drop down list.
4. In the search list of objects, select the RiSimulationDef with the most recent creation date, i.e. the one created by the Save Sim action, to highlight/select it.
5. From the Guru Browser menu options, select **Export > Send to Export List** as shown in [Figure 7.3](#).
6. The RiSimulationDef can then be [exported to a .GZP](#) and sent to RI support.

---

**CAUTION:** Do not export files to the C:/ drive. Save to an RI approved USB drive, networked drive, or to the D:/ drive.

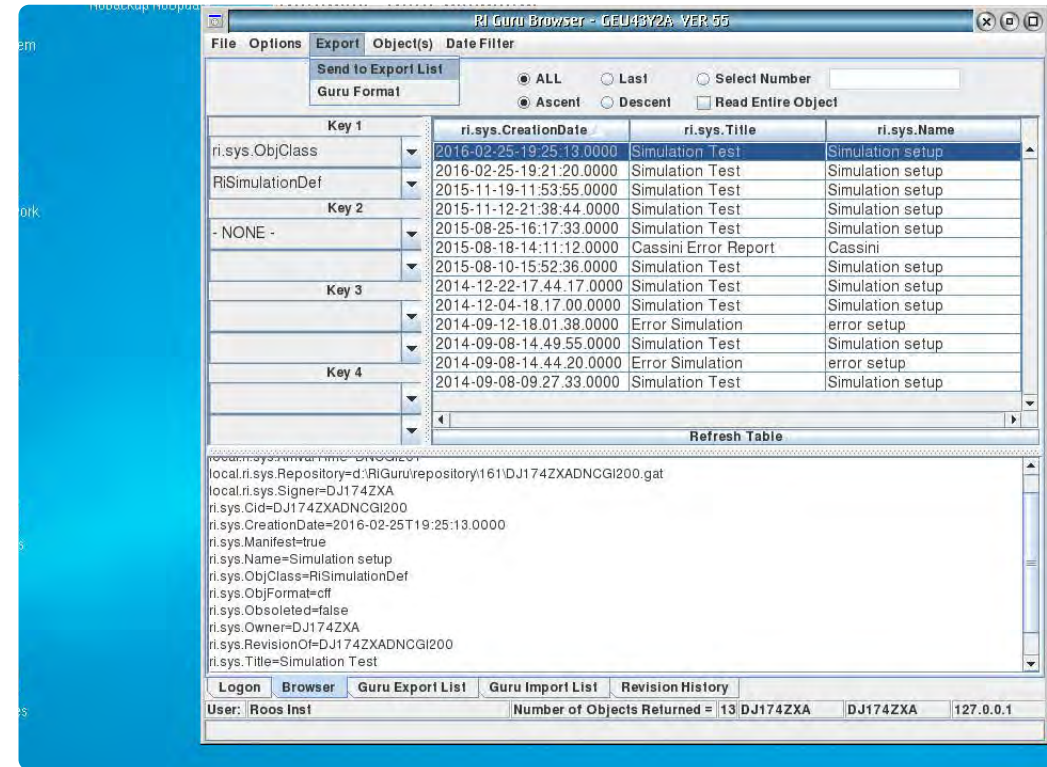
---

FIGURE 7.2 EXPORT SIMULATION



The screenshot above shows how to create a RiSimulationDef object of the current Cassini test system software configuration.

FIGURE 7.3 EXPORTING THE RISIMULATIONDEF



The screenshot above shows how to search Guru for a RiSimulationDef, organize the search results by creation date, and send the RiSimulationDef object to the export list.

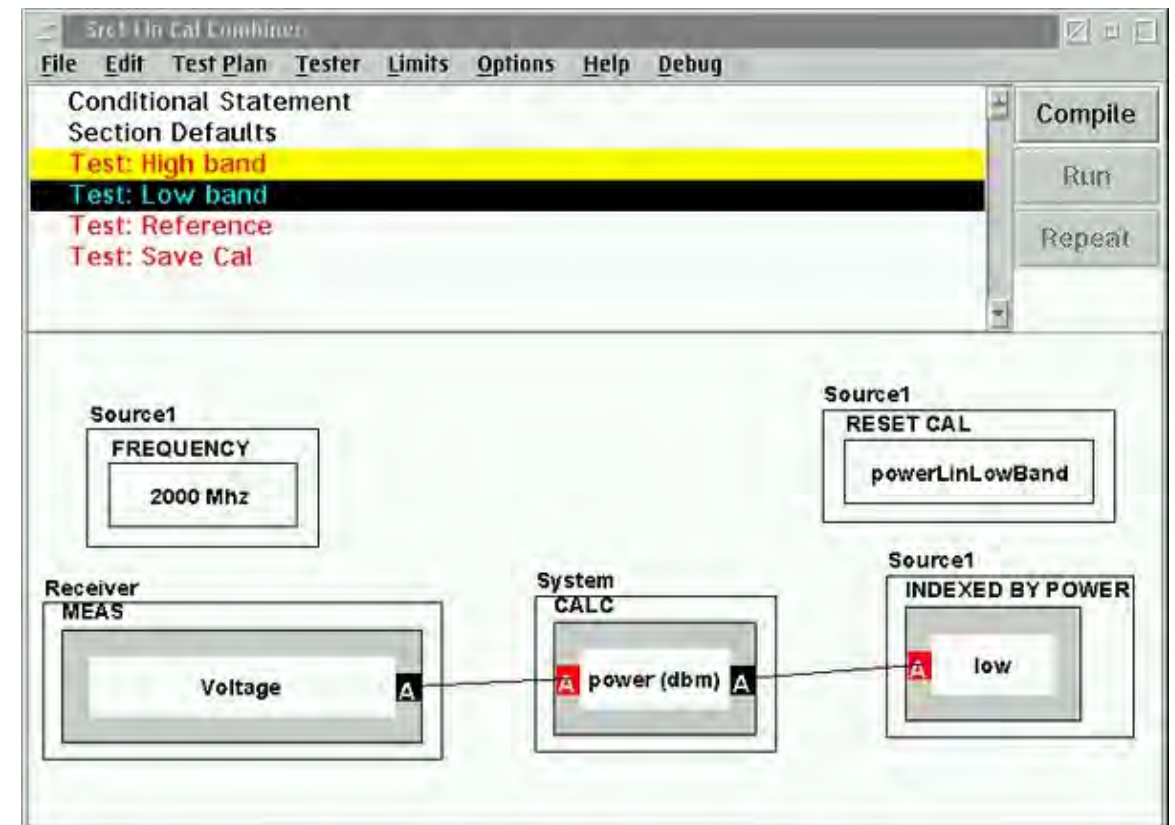
# BREAKPOINT & CONTROL

## SET BREAK POINTS

- **Options > Set Break Point**
- Changes color at the break point
- Can only break on a test, not on Section or Global Defaults.
- Test Plan will stop after setting up the hardware and taking the measurements
- Only 1 break point per test plan
- Can continue, single-step, abort, or open the control panel

**CAUTION:** Do not perform a system startup while at a break point.

FIGURE 7.4 SETTING BREAKPOINT



When setting a breakpoint, the line turns yellow indicating a breakpoint is present.

## CONTROL PANEL

The control panel can be accessed by selecting **Options > Control** menu selections from the Main System Window or from selecting the **Control** button from a breakpoint pop-up window. If reached from a breakpoint, the control panel will reflect the settings at the breakpoint.



---

**WARNING: The TIM settings are live and active at this point. The control panel allows for manual control of system instruments**

---

## DISABLING PARTS OF TEST SECTIONS

Disabling parts of test plans can increase speed or decrease confusion. The programmer message window will always say 'Fail' if any test or test section is disabled. To disable a section select **Edit > Disable/Enable** 'Selected' or 'Disable All' then re-enable selected sections.

There are a couple of reasons for disabling parts of a test during debug. One is to increase the speed of a test plan. This is particularly useful when doing a 'rattle' test. Another reason is to decrease confusion. If troubleshooting a problem, disabling a test or test section, will decrease the amount of data that needs to be processed while searching for a solution.

To disable a test, first click on the test the user wants disabled. Then, at the top of the test plan window, select **Edit > Disable/Enable selected**. This will disable the selected test. If the user wants to disable more than one test in a section, select **Edit > Disable All**. This will disable all the tests in that section. Then select the disabled tests the user wants enabled and select **Edit > Disable/Enable selected** to enable those selected tests.

## ABORTING A TEST PLAN

- Validate, Verify, or Diagnose can be aborted if necessary
- Perform by pressing **Ctrl + Break**
- System will show a walk-back error. Select 'Abort'.
- From Main System Window, select **System > Reset**
- Always do a system reset after aborting a test plan
- Cals can be aborted, but **only if absolutely necessary**. Cal data will be invalid.

Sometimes it may be necessary to abort a test plan. The reasons can vary, from missing a step specified in a condition statement, cal standards put in the wrong port, etc. All test plans can be aborted. Cal plans should only be aborted if absolutely necessary.

To abort a test plan, press Ctrl + Break. A walk-back error will appear. Select 'abort'. Then, in the 'Programmer Message Window', select **System > Reset**. It is important to ALWAYS reset the system after aborting a test plan to clear any Cal factors from memory. Most calibration plans reset the cal data when they compile, then insert new cal data when they run. If a cal plan is aborted, compiled but not yet ran, the old cal data has probably been lost.

When a group of calibrations/validates are executed successfully, a message will display 'Saving Cal Data' within the executive window upon completion. If the 'Validate' fails, the cal data is not saved.

If either of the above has occurred and the cal data has not been saved, the old cal data can be retrieved by selecting **System > Equip > Startup**. This restarts the system, loading the latest version of any object (including the valid calibration data) from Guru, but does not reapply patches.



# VIEWING DATA

In the Cassini graphical programming environment, captured data in Data Saves, Arrays, and Local Variables can be displayed with plot viewers to provide a visual representation of the data.

## TYPES OF VIEWERS

The **Moving Strip Chart** viewer, shown in [Figure 7.5](#), displays successive single measurement data points in time from left to right in the viewer. As a measurement/save is repeated, the most recent datapoint is appended to the plot to provide a running display over time.

The **Polar** viewer, shown in [Figure 7.6](#), displays data points in a polar coordinate system - where each point is determined by the distance from a reference point and an angle from a reference direction.

The **Rectangular** viewer, shown in [Figure 7.7](#), displays data points in a cartesian coordinate system with the measured data displayed on the y-axis and the dependent variable along the x-axis.

The **Smith** viewer, shown in [Figure 7.8](#), displays impedances, admittances, reflection coefficients, and/ scattering parameter data on the complex reflection coefficient plane in two dimensions with a normalized impedance of 50 ohms.

The **Strip Chart** viewer shown in [Figure 7.9](#), displays successive single measurement data points in time along the center line of the x-axis.

### To access the available data viewers:

1. Compile the test plan and execute a **Run** to populate data saves, or local variables with measurement values.

*NOTE: The test plan must be compiled in order to access the plot viewer. Plot view fields are populated after data is captured.*

2. Left click within the gray area of the measurement block, or data save/variable button to open the Select Viewer Window as shown in [Figure 7.10](#).
3. Left click on the desired plot view and click **Select** to open the viewer.

FIGURE 7.5 MOVING STRIP CHART PLOT EXAMPLE

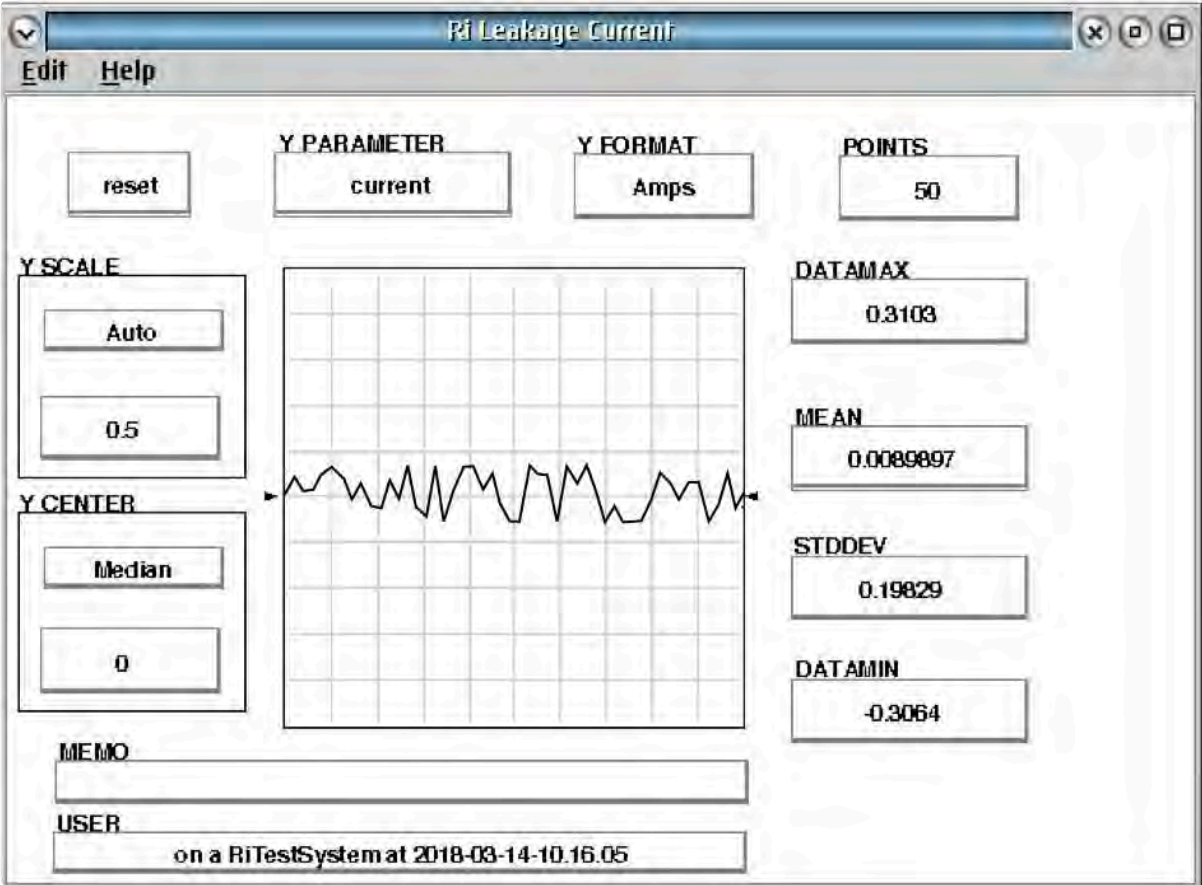


FIGURE 7.6 POLAR PLOT EXAMPLE

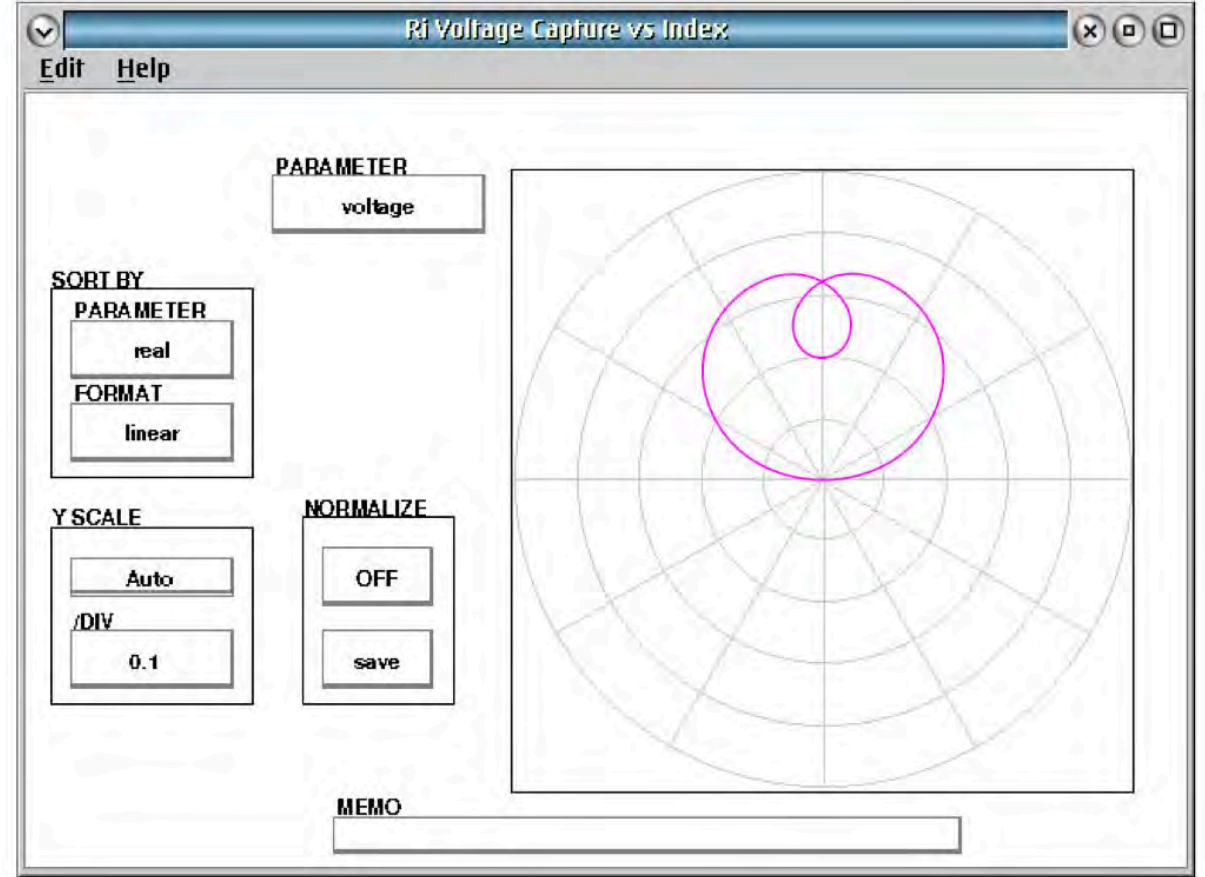


FIGURE 7.7 RECTANGULAR PLOT EXAMPLE

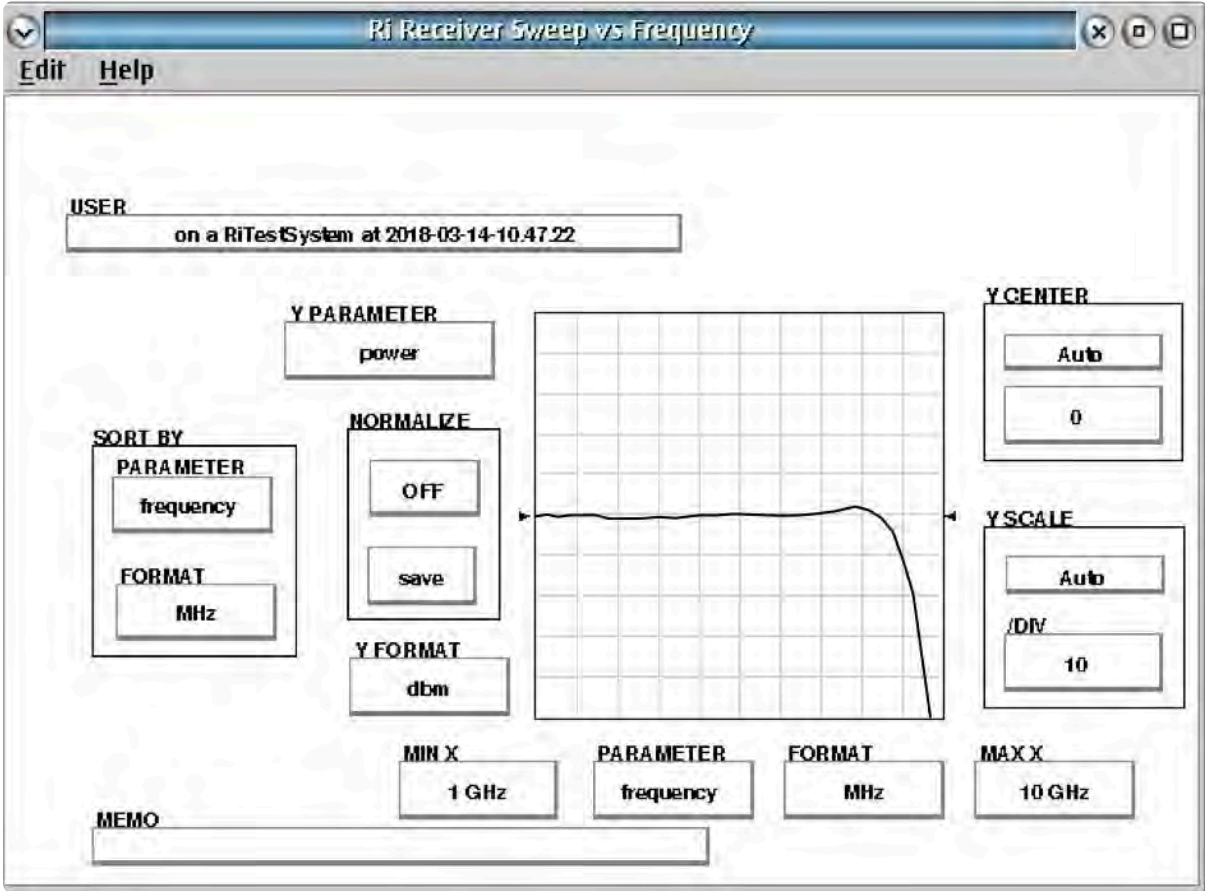


FIGURE 7.8 SMITH CHART PLOT EXAMPLE

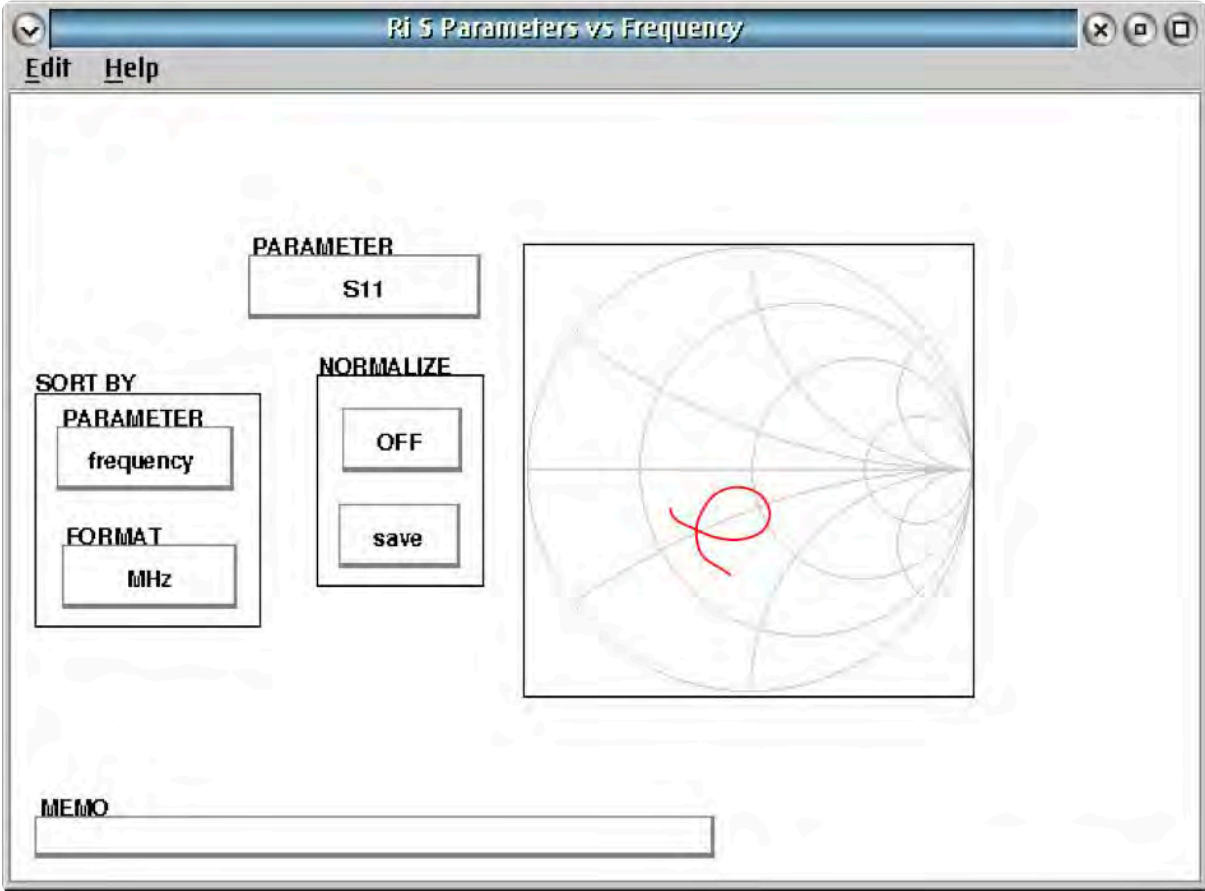
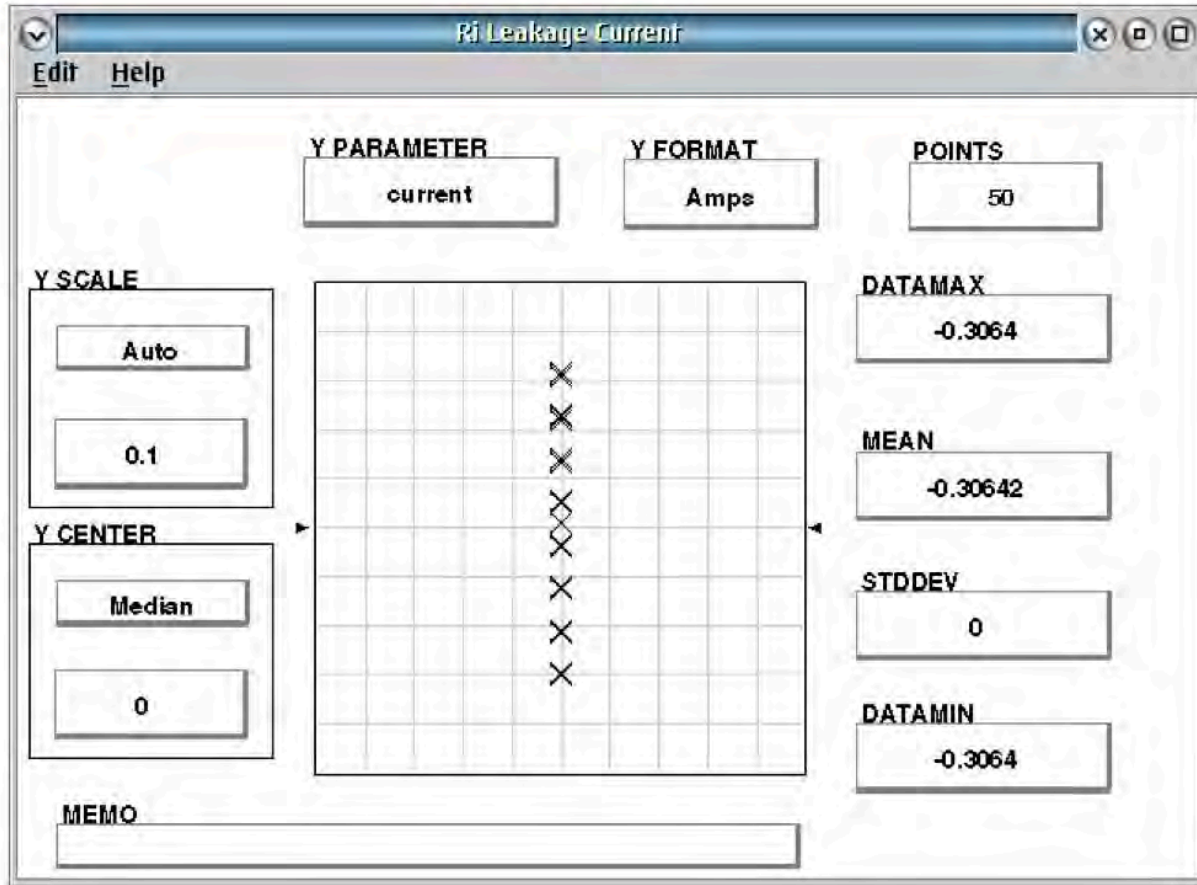
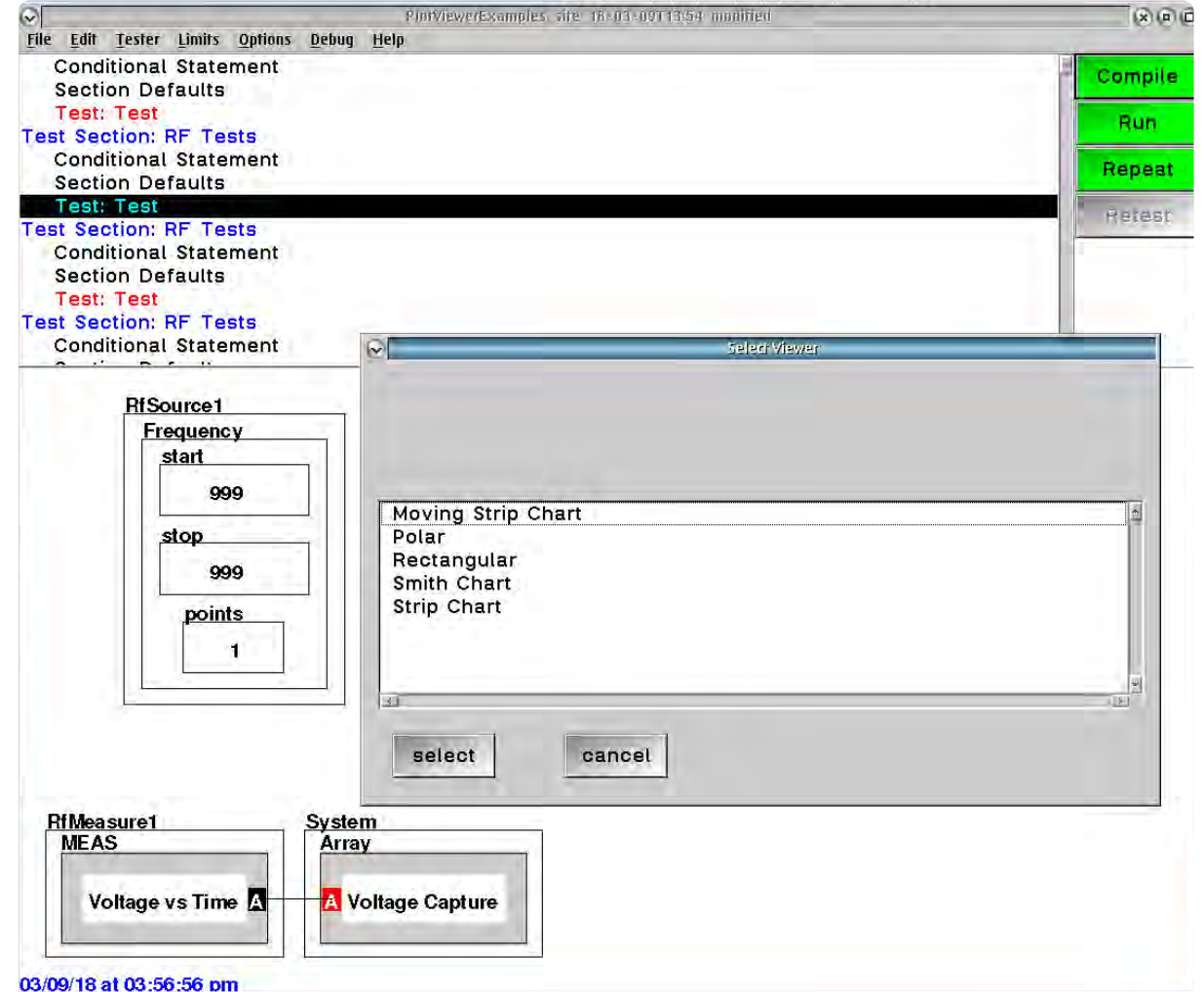


FIGURE 7.9 STRIP CHART PLOT EXAMPLE



The Strip Chart is typically used with the Overpaint and Line Type > Points menu options as shown above.

FIGURE 7.10 ACCESSING DATA PLOTS VIEWERS

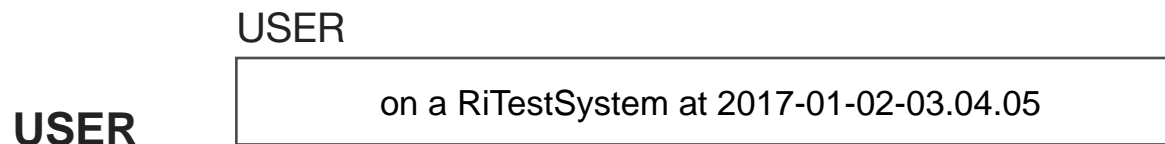


With a compiled test program, left click on any Data Save, Array, or Local Var button to open the Select Viewer window to access data plots.

## PLOT VIEW FIELDS

Within the plot viewer window are several display fields and plot view options described in the following text.

*NOTE: The viewer fields are populated after a Run of the test plan.*



The User option is a text field that is auto-filled with a time stamp to reflect the time of capture. The text field can be edited by left clicking within the field to open a text edit window.



Memo is a text field for optional documentation/commentary that can be edited by left clicking within the field to open a text edit window.

## Y PARAMETER



The Y Parameter field displays the data type of the y-axis values in the plot. This field is populated once the test panel is executed and data is available in the viewer. If there are multiple data types stored in a displayed array, the data type can be selected by left clicking on the field and selected the desired type.



The Normalize fields allow the user to view the difference between a user-specified reference plot and subsequent data in the plot viewer. The reference data/plot is selected by left clicking on the save field for the desired plot. To then plot the difference between the saved reference data and subsequent data runs in the plot viewer, left click on the OFF button to change its' value to ON. On a repeated run of the test program, the plot viewer will display the difference between the saved reference and the current run of data in the plot viewer. The ON/OFF button can be selected at anytime to switch between the



standard and normalize display in the plot viewer when a saved reference has been selected.

## Y FORMAT

The Y Format field sets the unit of measure of the y-axis in the plot viewer. It can be changed by left clicking on the field and selecting from the list of options.

Y FORMAT

log

*NOTE: The Y Format options are set by the Y Parameter field/data type of the displayed measurement, Data Save or variable.*

## MIN X

The Min X field displays the minimum value of the x-axis of the plot viewer. The default value is set by the lowest value of the independent variable or index such as a frequency sweep or power range of an instrument during a measurement. It can be set manually by the user by left clicking on the field and inputting a value within the range of available indices or index values.

MIN X

1

## MAX X

The Max X field displays the maximum value of the x-axis of the plot viewer. The default value is set by the highest value of the independent variable or index such as a frequency sweep or power range of an instrument during a measurement. It can be set manually by the user by left clicking on the field and inputting a value within the range of available indices or index values.

MAX X

1000

## PARAMETER

The Parameter field displays the data type of the x-axis values in the plot. This field is populated once the test panel is executed and data is available in the viewer. The field defaults to the data type of the independent variable after the test plan has been executed, i.e - 'frequency' for a frequency sweep or 'power' for a power range of an instrument during a measurement.

PARAMETER

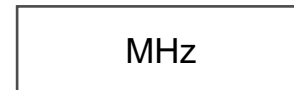
frequency



## FORMAT

The Format field sets the unit of measure of the x-axis in the plot viewer. It can be changed by left clicking on the field and selecting from the list of options. The field can be changed to display the indices of the independent variable by left clicking on the field and selecting 'index' from the options list.

### FORMAT

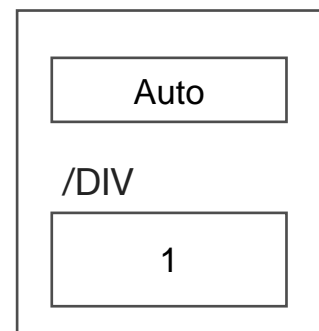


*NOTE: The Format options are set by the Parameter field. When plotting from a Data Save, the Format field defaults to selected Data Save format.*

## Y SCALE

The Y Scale options control the step size of the y-axis in the plot viewer display. The Auto field allows the user to set the y-axis scale to fit all values of the data within the plot viewer display by left clicking within Auto field box after data has been captured. The numerical field displays the y-axis scale/step size value and allows the user to set the

### Y SCALE

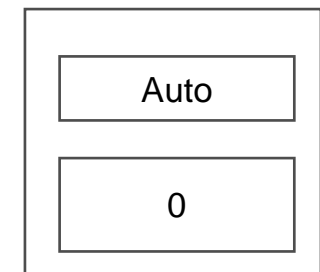


scale value by left clicking within the field and inputting the desired value in the pop-up window.

## Y CENTER

The Y Center options control the value of the centerline of the y-axis in the plot viewer display. The Auto field sets the y-axis center line value based on the average value of the data by left clicking within Auto field box once data has been captured. The numerical field displays the y-axis center line value and allows the user to set a value by left clicking within the field and inputting the desired value in the pop-up window.

### Y CENTER

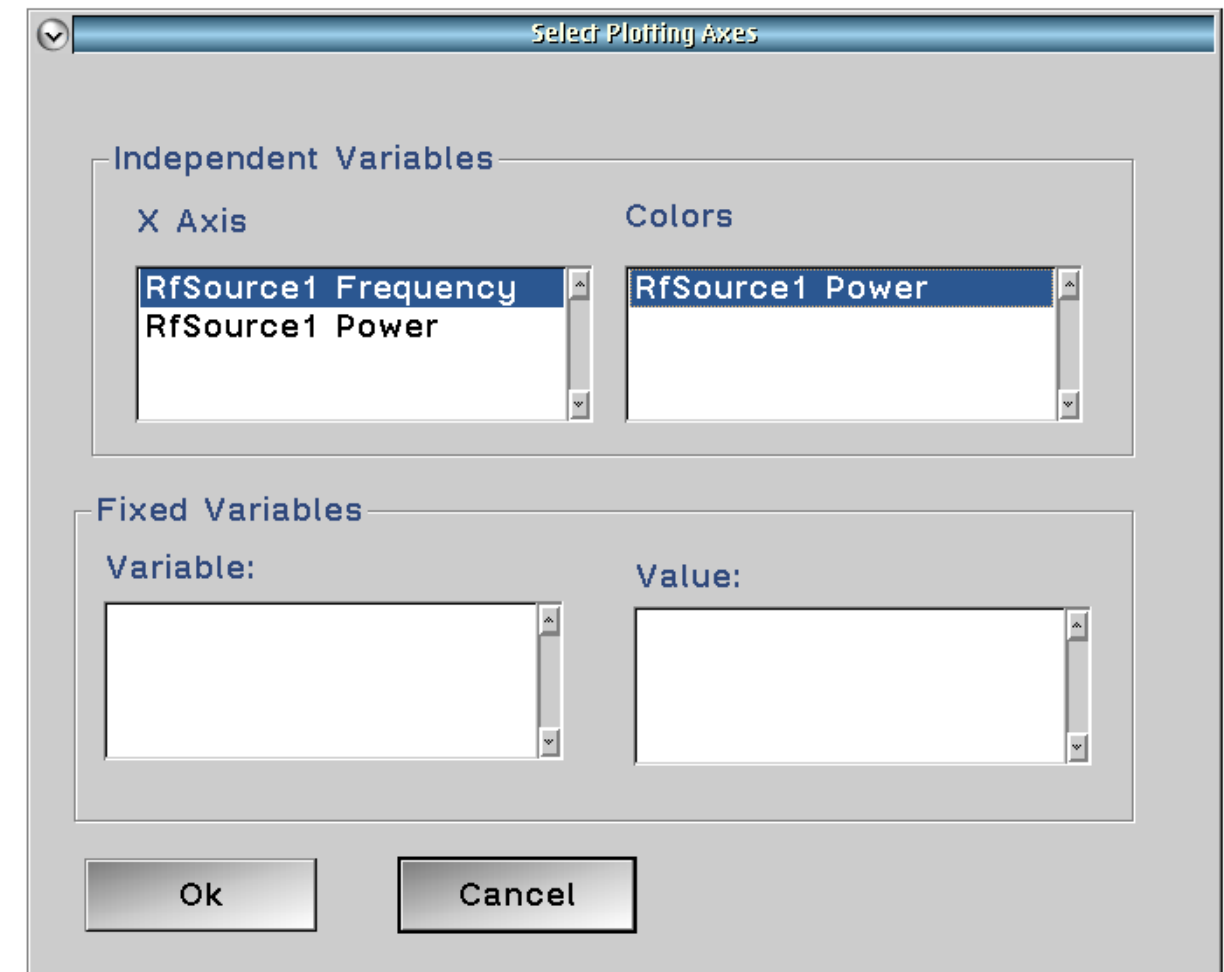


## MULTI-PARAMETER PLOTS

Measurements or data save/variables with multiple dependent variables such as measurements with frequency and power range sweeps can be viewed with multi-parameter plots as shown in [Figure 7.12](#). This mode is activated automatically when measurement data is created with multiple independent variables in a test panel. Multi-parameter plots allow the user to view plots with two independent variables. Once the plot type is selected, the user is prompted to select the plot axes from the available independent variables in the Select Plotting Axes window as shown in [Figure 7.11](#) and described below:

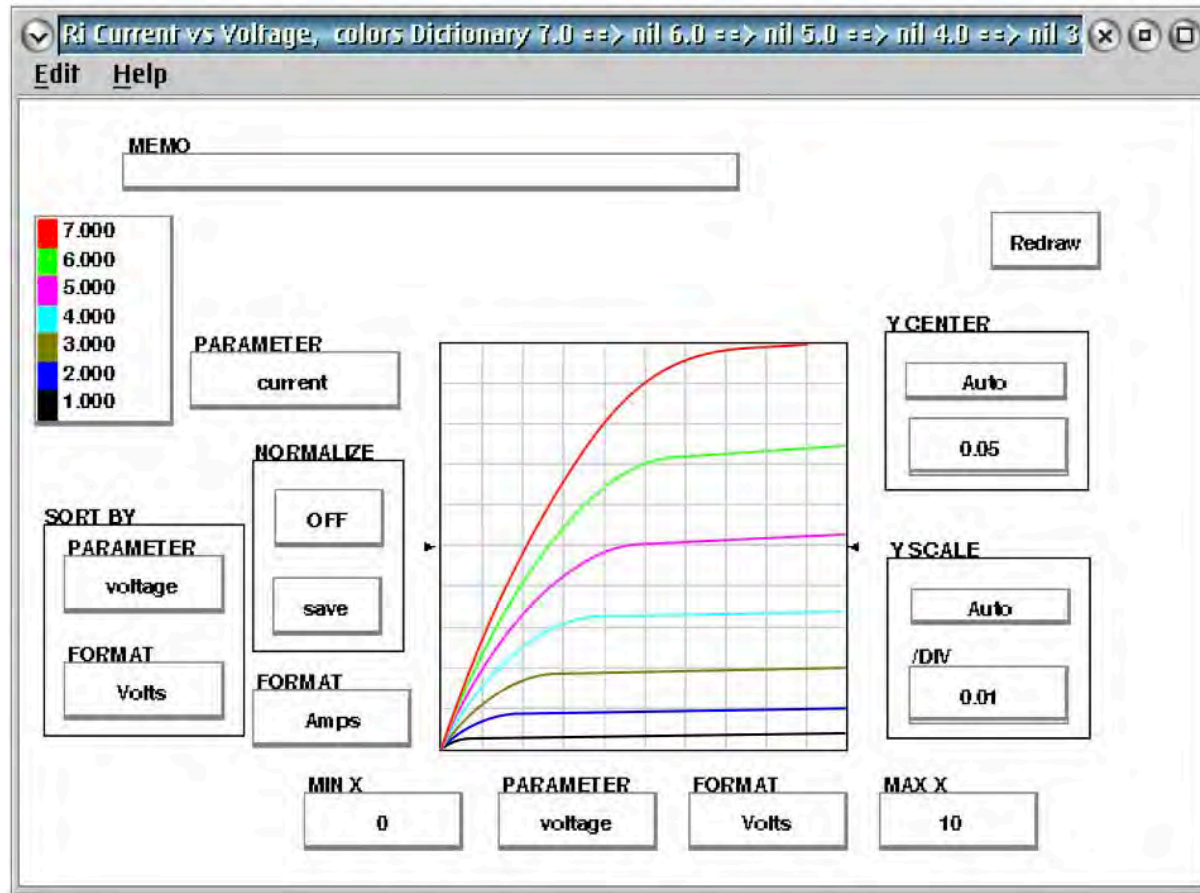
1. Select the x-axis variable by left clicking on the desired parameter to highlight it.
2. The remain variables become available as selections in the color parameter. Left clicking on the desired parameter to highlight it.
3. If more than two independent variables are available for the data, the remaining unselected variables must be held constant by selecting them and setting them to an available value in the Fixed Variables section.

FIGURE 7.11 SELECT PLOTTING AXES WINDOW



Multi-parameter plots allow the user to select(highlighted) an X-Axis and Color independent variable. Any remaining independent variables must be set to a value in the Fixed Variable lists.

FIGURE 7.12 MULTI-PARAMETER PLOT EXAMPLE

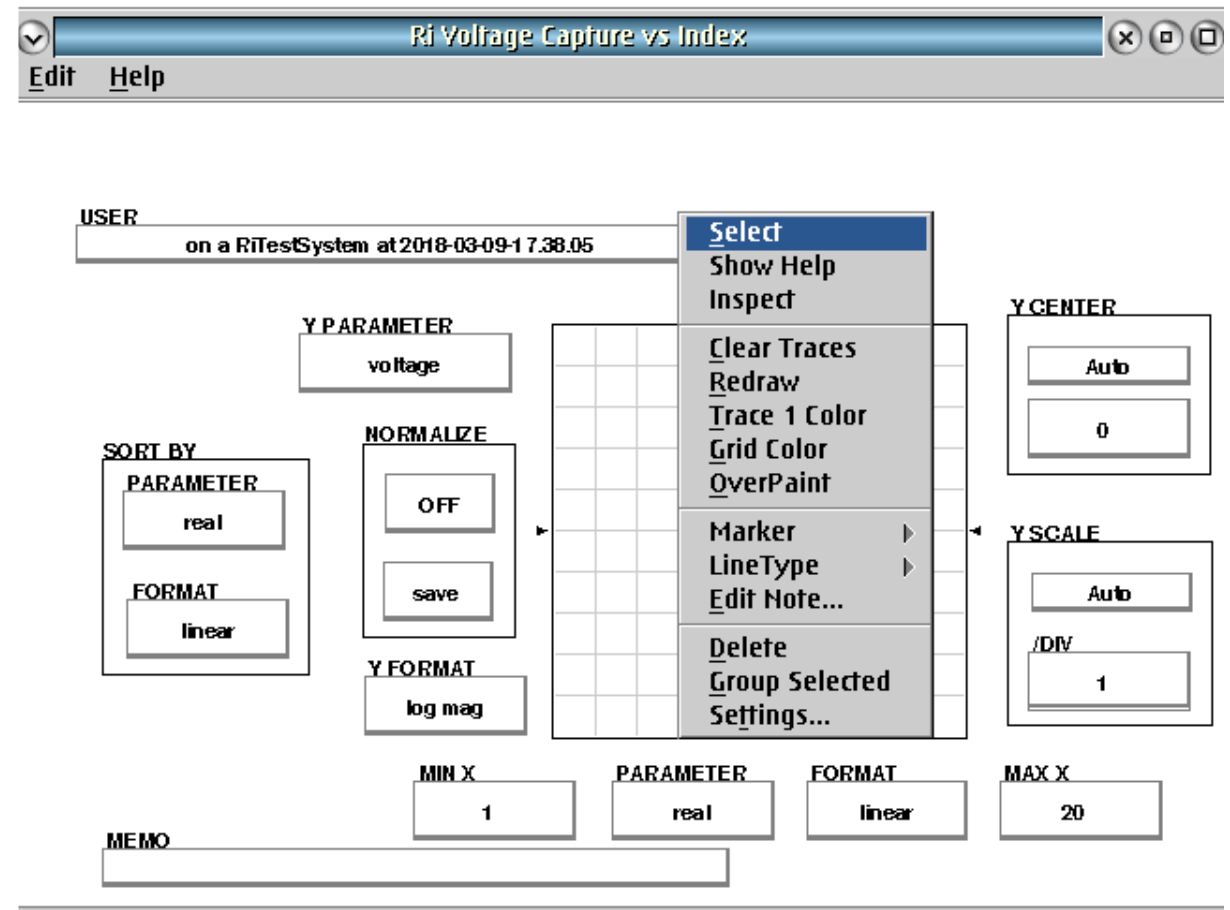


The multi-parameter plot is typically used with the Overpaint feature as shown above.

## PLOT MENU OPTIONS

The plot menu options provide additional plot and display features of the viewers. It can be accessed by right clicking within the plot viewer graph as shown in Figure 7.13. The following text describes the menu options and their functions.

FIGURE 7.13 ACCESSING THE PLOT MENU OPTIONS



Right click on the graph display to access the pop-up menu options.

The **Clear Traces** option removes all plots from the viewer display.

The **Redraw** option refreshes the display view with the last data plot only.

*NOTE: Only the last run of data can be re-rendered with the Redraw' feature.*

The **Trace 1 Color** option sets the color all subsequent plots of the data in the viewer from a list of colors.

*NOTE: This option can be used in conjunction with the 'Redraw' option to update the current plot with the selected 'Trace 1 Color' option.*

The **Grid Color** option sets the color of the display grid from a list of colors for all subsequent plots of the data in the viewer.

The **Overpaint** option provides plot persistence, allowing repeated runs of the data to be retained in the plot display. This option is often used in conjunction with the Trace 1 Color option to differentiate data runs.

*NOTE: Only the last run of data can be re-rendered with the Redraw option or changes to the Y Scale, Y center, Min X, and Max X plot view fields.*

The **Marker** menu provides options for indicators that display the corresponding x-axis and y-axis values in the plot graph:

The **Marker > Clear** option removes all markers from the plot.

The **Marker > Max** places a marker on the maximum y-axis value of the last trace in the display.

The **Marker > Min** places a marker on the minimum y-axis value of the last trace in the display.

The **Marker > X** places a marker on the last trace in the display at the corresponding x-axis value input by the user. See [Figure -.-](#) for an example.

*NOTE: Generic markers can be placed anywhere within the display graph by left clicking on the desired location. Left-click and drag performs a set of delta markers between the first left-click location and the location where the left mouse button is released.*

The **LineType** menu provides options for the display of data points and data curves in the plot viewer:

The **LineType > Normal** option is the default mode of the data plot viewer and displays a linearly interpolated curve between data points in the graph display.

The **LineType > Smooth** option displays a third-order polynomial spline curve between data points in the graph display.

The **LineType > Points** option displays each data point with an X and no curve between data points.

The **LineType > Histogram**, **LineType > CDF**, **LineType > Peaks**, and **LineType > Binary** are no longer supported.

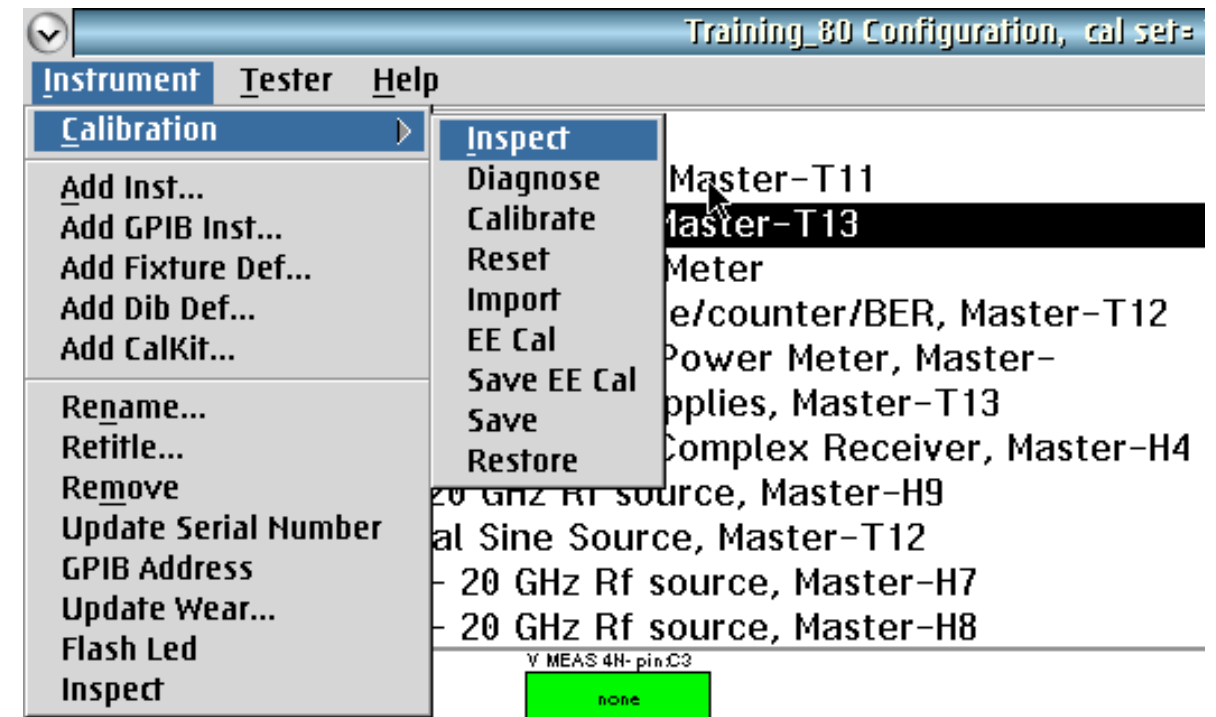
# INSPECTING CALIBRATION DATA

Calibration data is stored as path names tied to an Instrument's unique internal identifier and the TIM's serial number. A TIM may contain multiple Instruments. Calibrations are saved only after every Validate PASS and may affect multiple instruments and TIMs.

Most problems are diagnosed by inspecting calibration data, setting breakpoints, and directly controlling the system for the suspected instrument.

1. Choose **System > Tester**, to open the configuration window.
2. Left mouse click the instrument to highlight it.
3. From the menu options, select **Instrument > Calibration > Inspect** to open a Calibration Data viewer as shown in [Figure 7.14](#).
4. Left mouse click on a calibration name to select it in the list and view the data in the right pane.
5. Right mouse click on the highlighted calibration data and select 'View' from the pop-up menu to open the calibration data in a

FIGURE 7.14 ACCESSING CAL DATA

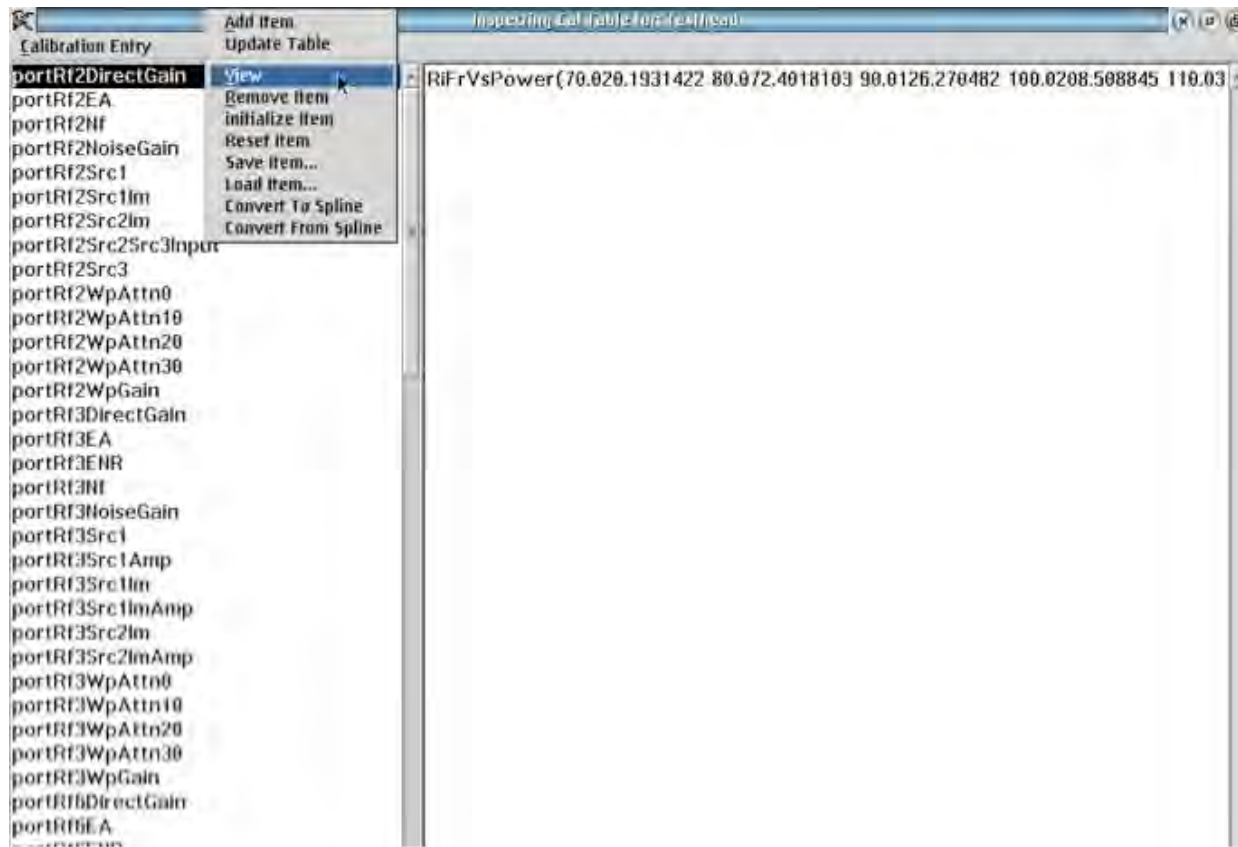


Inspect Calibration data for each instrument using the Variable Inspection Window

graphing plot as described in the Diagnostics Chapter's "[Viewing Data](#)" section.

**WARNING: Do not edit calibration data. Altered calibration data can cause erroneous signal outputs, measurements, and/or unexpected software errors.**

FIGURE 7.15 ACCESSING CAL VARIABLES DATA



RMB click on any Calibration variable allows for viewing of that data for each instrument using the data viewers.

## VIEWING DATA WITH GRAPHS

For more information about Graphs, [see Viewing Data section](#) of the Diagnostics Chapter.



# CHECKING FOR VALID CALIBRATION DATA

## OVERVIEW

Invalid calibration data can cause a fully functioning TIM to report a failure result when performing Diagnostics. Use the Configuration window to confirm that the Date and Time of the Cal Data is valid. (See [Calibration and Diagnostic Information](#))

If the TIM was recently installed from a factory repair, the Date and Time should be less than a week. If the TIM participates in the RF System, all TIM instruments should have the similar Date and Time that is not earlier than the system's last Calibration date.

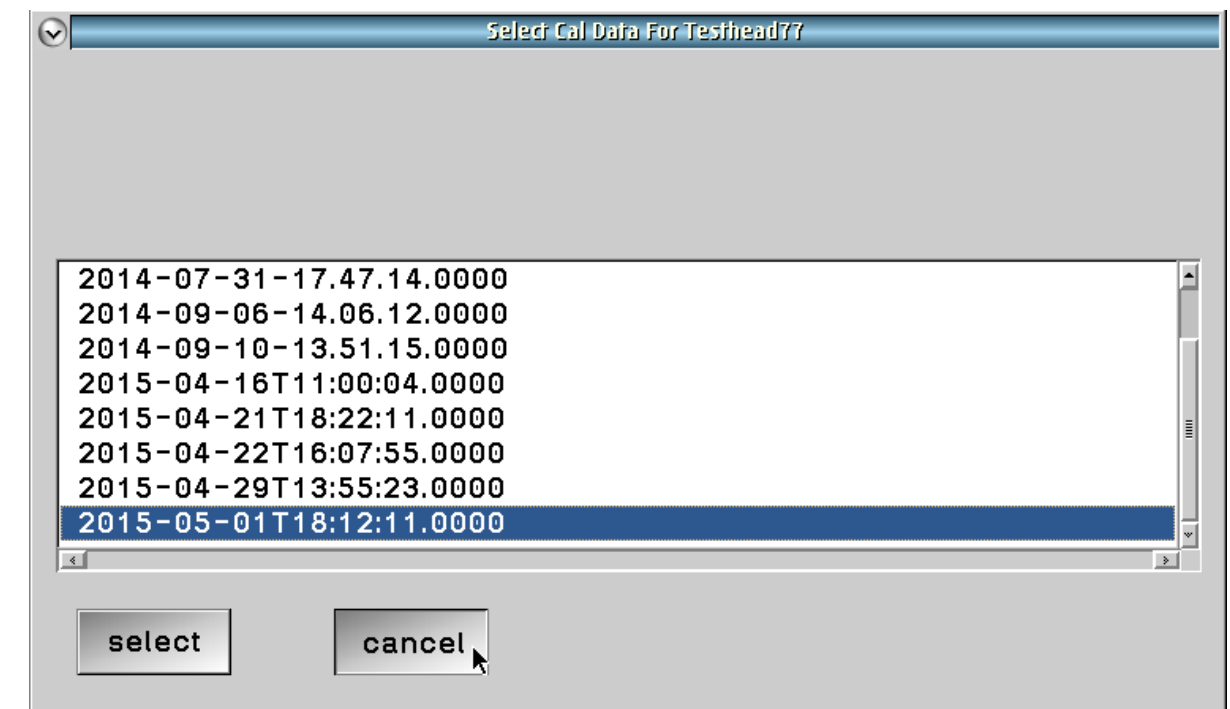
**CAUTION:** Using the Calibration > Restore function can replace the calibration data of the selected TIM. Always “cancel” the restore when only inspecting the TIM's calibration date and time.

To inspect the Instrument's Calibration Date and Time:

1. Open the Tester Configuration window by choosing **System > Tester** from the Cassini main system window.

2. Select any Instrument, RMB click and choose **Calibration > Restore**. Confirm by pressing **OK** button, even though we will NOT be changing the Cal Data. The Date and Time at the bottom of the list represents the currently loaded Cal data.
3. Choose **cancel** to close the window without affecting the Cal Data. If **select** was pressed, a new Cal Data entry will appear with

FIGURE 7.16 INSPECTING CAL DATA FOR INSTRUMENT



The last Date and Time listed is the current Cal Data that is loaded. If that date is before the last know system Cal Date or before the date it was sent to RI for repair, try loading the Cal Data from RI or follow the Calibration Procedure for the stand alone TIM or all the RF System TIMs.

the current date and time. Data is never deleted, only saved as the most recent.

# ERROR AND WARNING MESSAGES

## MESSAGES WINDOW

The System Software displays warning and error messages in the Messages Window or Log File that acts as the console for the system software. The message window will appear automatically when messages are first displayed. New messages appear at the bottom and will scroll old messages up.

This window can be opened by selecting **System > Messages** from the Cassini main system window.

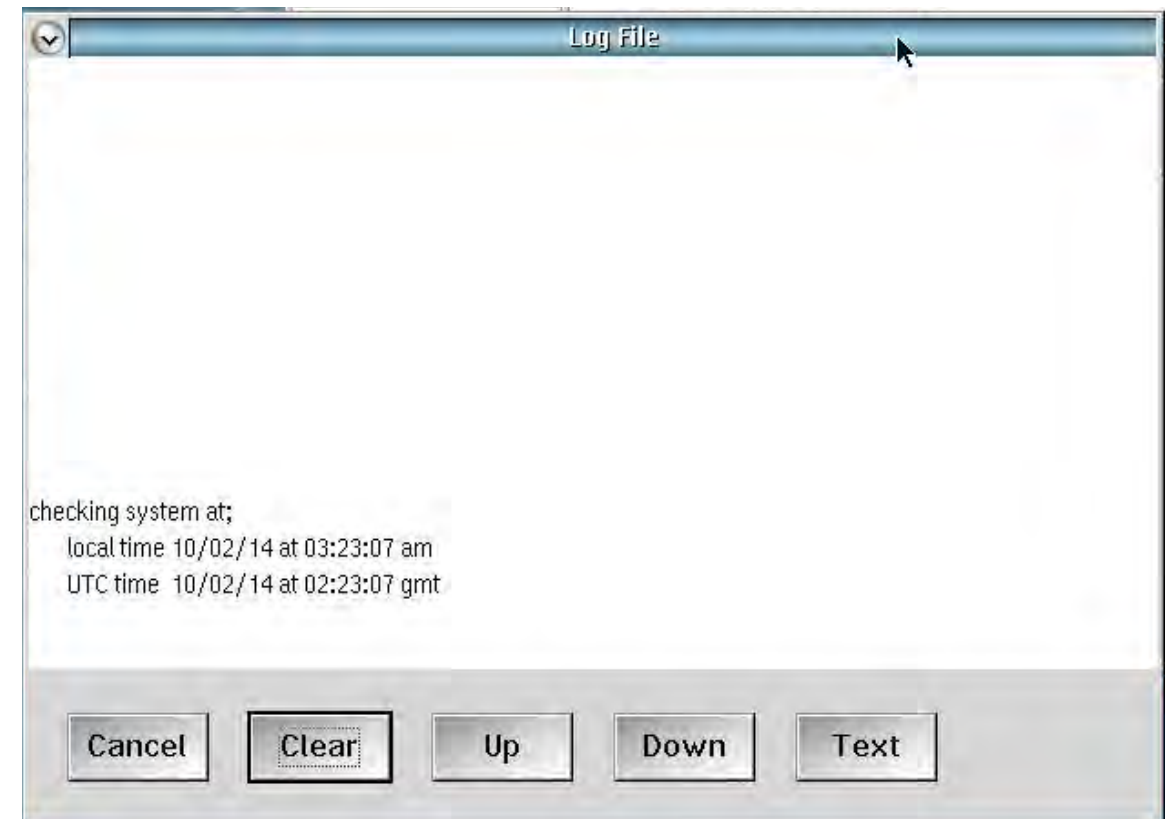
Choose the **Cancel** button to close the Log File menu.

Use the **Less** button to scroll down to the most recent message, **More** button to scroll up to the oldest message and **Clear** button to erase all messages.

Choose **Text** button to convert the current log into a text file that can be saved or edited.

*NOTE: Important error and warning messages appear in red.*

FIGURE 7.17 LOG FILE WINDOW



This window displays warning and error messages as well as standard console messages.

# SOFTWARE ERRORS AND RECOVERY

## RI SOFTWARE EXECUTION ERROR HALT

1. When an Error Dialog box appears select "Save". A vRtError.log file is automatically created and is located in the D:\RiApps\GuruApps\GF10RC2A directory. This will assist RI Support in recreating the conditions of the issue.
2. If developing Test Plans using the Test Plan editor, select **File > Clear Compile**. This will clear out the memory allocated to the Test Plan and reset the pointers so the Test Plan will be ready to compile again. If the error persists check your Test Panels for errors and then move to step 3.
3. In the Cassini application window, select **System > Reset**. This will reset all the system variables, including reloading calibration data, and terminates multithreaded processes. If a hardware error exists, it must first be cleared and the reset process repeated.
4. Attempt your task again, if the issue persists, contact RI Support.

## SOFTWARE RECOVERY - FIRST ATTEMPT

If a hardware issue cannot be resolved by closing the offending program, it may be necessary to interrupt the operating system to remedy the issue. Follow the instructions below for terminating unresponsive programs.

1. Press and hold Ctrl+Break. This will halt any running RI Application program and display an error dialog box.
2. Select "Save" to close the Failure dialog box.
3. From the Cassini main system window, select **System > Reset**. This will reset all the system variables and terminates multithreaded processes. If a hardware error exists, it must first be cleared and the reset process repeated starting at step 1.
4. If the issue persists, Contact Roos Instruments support ([support@roos.com](mailto:support@roos.com)) including the vRtError.log file located in the Guru application directory as well as the procedure to recreate the issue. This will assist RI in recreating the conditions of the issue.
5. Select the Cassini application window then select **System > Quit**. A dialog box will appear that asks, "Are you sure?", select 'YES'.
6. Restart the Cassini application and follow the standard startup procedure.

## SOFTWARE RECOVERY - SECOND ATTEMPT

In the event that a hardware or RI system software issue is not resolved, it may become necessary to interrupt the frozen RI system software and have the eCS operating system terminate its operation.

1. Press and hold Ctrl + ESC. This will display a Window List (system process) dialog box will be displayed.
2. Right click on the Cassini application, then select Close from the pop-up menu. Click 'Yes' to terminate the RI System software.
3. Once the system CPU monitor goes to zero, restart the RI System Software.

## SOFTWARE RECOVERY - FINAL OPTION

If a hard operation system crash occurs, it becomes necessary to interrupt the frozen User Interface and have the BIOS terminate the operating system.

1. Press and hold Ctrl+Alt+Delete keys. A blue recovery screen will appear.
2. Use "Top" (Press "T") to identify and kill any processes that are consuming CPU resources. Press "K" and enter a process number. After killing any processes, press ESC twice to return to the User Interface.
3. If problem persists, press Ctrl + Alt + Delete Key and try to Reset WPS (Press "W"), then press ESC to return to the User Interface.

4. If the UI is still not responding, Press CTRL + ALT + DELETE Key once to get the blue recovery screen and then CTRL+ALT+DEL keys again to reboot.
5. Once the system controller restarts, start the RI System Software again.

*NOTE: The RI System saves each part's test data after all of that part's tests have been performed. Lot data is saved to Guru periodically (every 100 parts), so that most test data for a lot can often be recovered using the STDF Recovery agent.*

## DOCUMENTING SOFTWARE ISSUES

If a user reports a software anomaly, please help us make the product better by e-mailing [support@roos.com](mailto:support@roos.com) with the following information:

- ShortCut used.
- Description of the issue found.
- Procedure to duplicate the issue.
- Text copies of any error messages and the error save file, vRtError.log from the D:\RiApps\GuruApps\GF10RC2A directory.

*NOTE: Error logs are saved in the program's directory organized by Guru ID, use the Guru App table on the next page to identify common product IDs.*

# SYSTEM CONTROLLER (EPC) ISSUES

## SYSTEM CONTROLLER (EPC) ISSUES

- Startup Failure? Access Recovery Menu (ALT + F1 to enter recovery menu)
- Press "1" to restore desktop (restore factory UI, all Guru Apps settings preserved)
- Press "F2" to enter command prompt
- TIM swap for hardware failure (including HDD)

---

**WARNING: Always contact Roos Instruments support prior to attempting any of the following troubleshooting steps.**

---

Roos Instruments support may instruct the user to enter the command line and be given specific instructions on what to change. If the system controller (EPC) fails to load, press ALT + F1, then press "1" to restart from the factory configured Archive.

There are two function key combinations that can be activated while the white blob appears on the screen followed by the word OS/2. These are Alt+F1 which will interrupt the boot process and take the user to a recovery menu, and Alt+F2 which will continue the boot while displaying the name of each device driver as it is loaded to help identify the driver causing problems.

The recovery menu that comes up when the user presses Alt+F1 contains options to help star the system, although in some cases the system may still not be recoverable. Options contained in this menu include:

- **ESC** to continue with the normal boot process
- **1, 2, or 3** to restart from one of the last three archives that the user created.

*NOTE: The restored archive does not affect any Guru settings.*

- **F2** to boot to a command line without starting the graphical interface. From here "MAKEINI" can be ran to rebuild the desktop or use "TEDIT" (a small command line editor) to fix corrupted configuration files.
- **F3** to reset the video mode back to VGA, bypassing the installed graphics driver. A useful option if the video driver gets corrupted or is set up incorrectly.



- **F4** to restart the system with a maintenance desktop. From here selective reinstall options can be used to rebuild the corrupted part of the system.
- **F5** enables FULL hardware detection.
- **F6** disables hardware detection. This is useful if there are problems with plug and play adapters.
- **0** recovers from the original archive of the system setup that was taken when the system was first installed.

## GURU SERVER (VM OR LINUX) ISSUES

- Reload Guru: From "Guru bar" select **System > Shutdown**
- Guru Server ("startApp.sh" and "es" processes)
- Kill process: "**ps -A > grep es**" to see PID, "**kill -p <PID>**" for each PID

---

**WARNING: Always contact Roos Instruments support prior to attempting any of the following troubleshooting steps.**

---

The Guru Server runs on a Virtual Machine or native Linux server. A dedicated user "riguru" should be created on the host OS. The program is installed in the "\$HOME/RiApps" directory or "~/RiApps/" folder and data stored in "~/RiGuru/" folder.

The process is launched by a "startApp.sh" that should be added to the GUI's desktop (KDE or Gnome) standard auto-start location.

*NOTE: A GUI is required because Guru Server cannot launch without a GUI.*

When Guru starts, the program files are always copied fresh from the "guruServer.zip" container and then launched. This step assures consistency and prevents any random HDD read or write errors related to aging from interfering with the program launch. If the script fails to properly unpack the program from the guruServer.zip file, the script launches the version that remains on the disk.

To prevent Guru from restarting, kill the "startApp.sh" process. Normally the Guru Server application automatically restarts when the user selects **System > Shutdown**. This prevents the service from being inadvertently shutdown.

If the Guru server is unresponsive or needs to be stopped for any reason, the user can open a command window as root and issue "**ps -A > grep es**" command to see the process ID (PID) of the Guru server. Force the process to stop with "**kill -p <PID>**" for each process identified. If the problem persists after a restart, copy "guruServer.zip" from a known working backup. If the problem continues, try restarting the host OS. Some OS upgrades may remove or relocate critical system files and may require a symlink ("ln -s /path/to/file") to be created to maintain backward compatibility.

If a walkback occurs, select "SAVE" from the dialog box and send the error log (~/.RiApps/vterror.log) to [support@roos.com](mailto:support@roos.com).

## GURU CLIENT (SYSTEM CONTROLLER) ISSUES

- Reload Guru: From "Guru bar" select **System > Shutdown**
- If Guru Client hangs: Ctrl + ESC, select "Guru" window, hit DEL
- Still not responding? CTRL + ALT + DEL, TOP, "guruServer" process

---

**WARNING: Always contact Roos Instruments support prior to attempting any of the following troubleshooting steps.**

---

The Guru client runs on the RI System Controller powered by an embedded OS/2 based operating system. No user accounts are required on the host OS. The program is installed on "D:\RiApps" and the data directory is "D:\RiGuru".

The process is launched by the **Local System > Startup** folder as "RI Guru Startup" (or similar).

When Guru starts, the program files are always copied fresh from the "guruServer.zip" container and then launched. This step assures consistency and prevents any random HDD read or write errors related to aging from interfering with the program launch. If guruServer.zip is corrupted, the program will eventually attempt to launch the previous unpacked version.

To prevent Guru from restarting, kill the "Guru Server Startup" process. The Guru Server application automatically restarts when "Shutdown", this is how Guru is automatically upgraded and prevents the service from being inadvertently shutdown. The Guru Client application will automatically restart when Shutdown, this is to prevent users from accidentally closing Guru.

# RECOVER FILES WITH GURU BROWSER

The Guru Browser application allows the user to browse, recover, import, and export files from the Guru database as Guru objects.

After logging on to Guru, select **Apps > Guru Browser**.

FIGURE 7.18 SELECTING GURU BROWSER

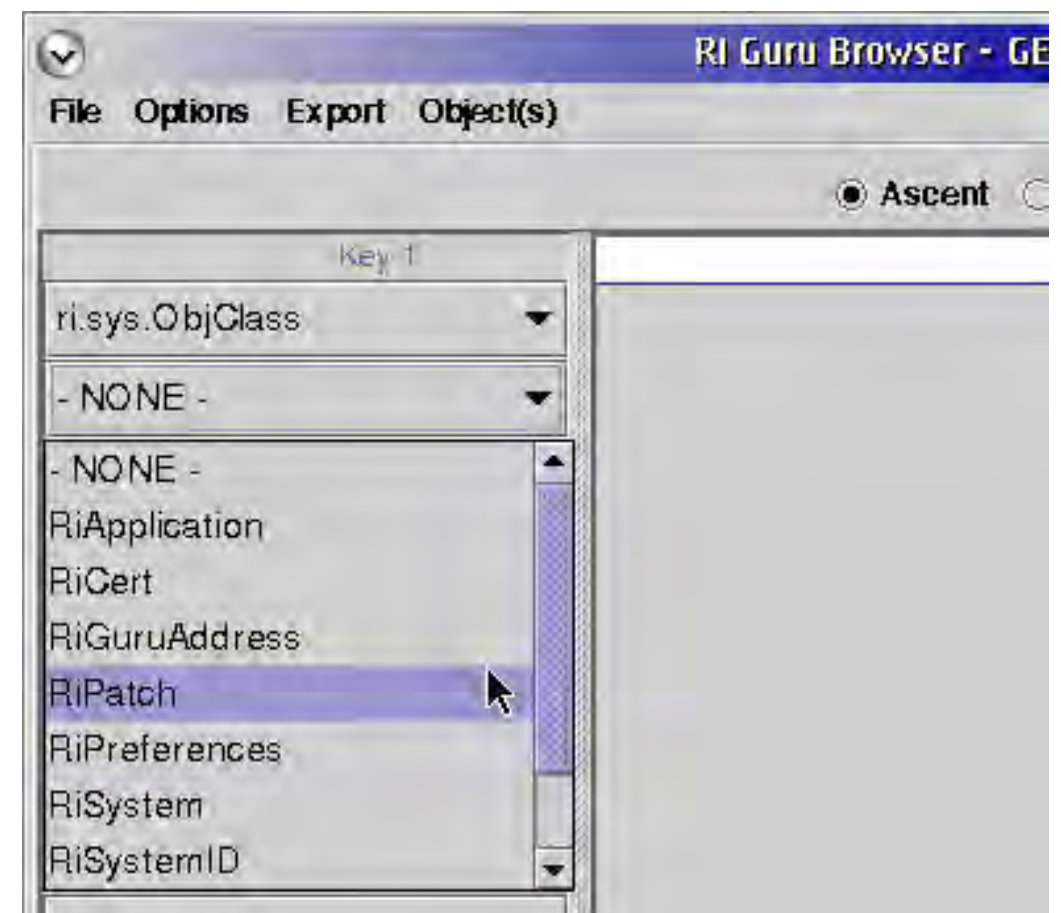


## BROWSING GURU OBJECTS

Upon opening the Guru Browser, the user should specify a search parameter or 'Key 1' to identify which Guru object attribute the user would like to browse, by default this is set to ri.sys.ObjClass.

For example, if the user wants to browse the RiPatch objects, choose the RiPatch from the list and all available RI Patches are displayed to the right side of the window.

FIGURE 7.19 GURU BROWSER



By default the Guru Browser is set to ri.sys.ObjClass

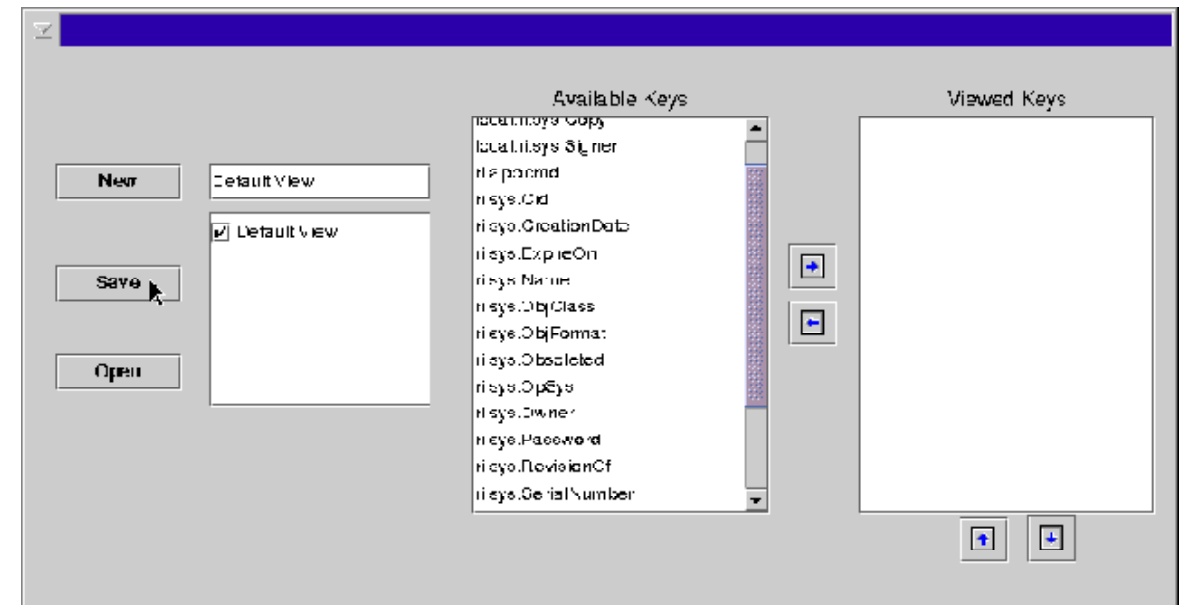
To specify what information is displayed select **Options > Config Table View**. The default window displays the `ri.sys.Name` and `ri.sys.CreationDate` information. The information can be sorted by selecting **Ascent** or **Descent**. Select **Refresh Table** below the object list to refresh the table and apply the sorting selection. The user can also choose to display all of the available objects by choosing **All**, or only display the last object by choosing **Last**, or specify how many objects are displayed by choosing **SelectNumber** and entering the maximum number of objects to display.

FIGURE 7.20 BROWSING RIPATCH GURU OBJECTS



The right side of the window shows the Guru Objects

FIGURE 7.21 CONFIG TABLE VIEW



The Available Keys column displays what information is available. Selecting an Available Key and clicking the arrow pointing right will add the key to the Viewed Keys. To remove select the key in the Viewed Keys column and click the arrow pointing left. To reorder the keys in the Viewed Keys column click the up and down arrows. When done, select **Save**.



## EXPORTING A GURU OBJECT

To export a Guru object using the Guru Browser application, select the object to be exported. Right click the object, and select **Export > send to Export List**. At the bottom of the RI Guru Browser window, select the **Guru Export List** tab. It is possible to export more than one Guru objects at a time. When finished adding all of the Guru objects to be exported, select **Export**. Enter any comment the user would like to add to the export objects.

Select a directory the user wants to save the exported file at by selecting the 'Look in:' field; and enter a filename in the 'File name:' field. Typically, the user would leave the file type as default (.gzp). When done making your selections, click **Export**. This will create a Guru Zip file that includes all the objects that were selected and can now be saved, stored or transported to another Guru. This is very useful for sending files or objects to RI for support questions etc.

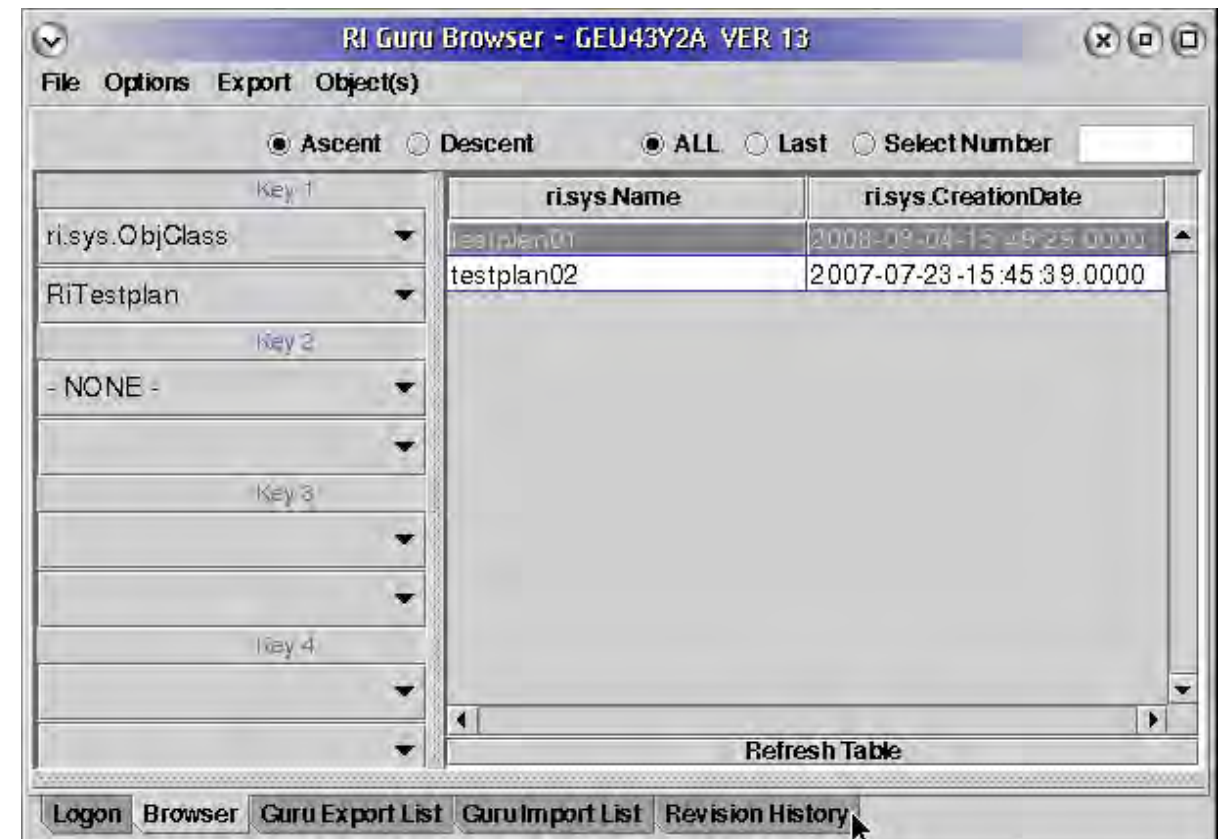
## IMPORTING A GURU OBJECT

To import a Guru zip file that includes Guru objects, use the Guru Browser application. Select the **Guru Import List** tab of the Guru Browser window. Click on the **Get Import File(s)** button to select which Guru objects to import to the local Guru. Select the directory and filename for the imported file, then click on the Import button. Press the "Import" button in the Guru Browser to add the selected files to the local Guru.

## RECOVER A GURU OBJECT

To recover a Guru object using the Guru Browser application, select the object the user wants to recover and make it the last revision. The following window displays an example of recovering RiTest Plan object with title of test plan01. First, 'key1' is set to ri.sys.ObjClass and select RiTest Plan as the object class. Then, select test plan01 from the list. Once a Guru object has been selected, click the Revision History page the bottom of the window.

FIGURE 7.22 RECOVER A GURU OBJECT

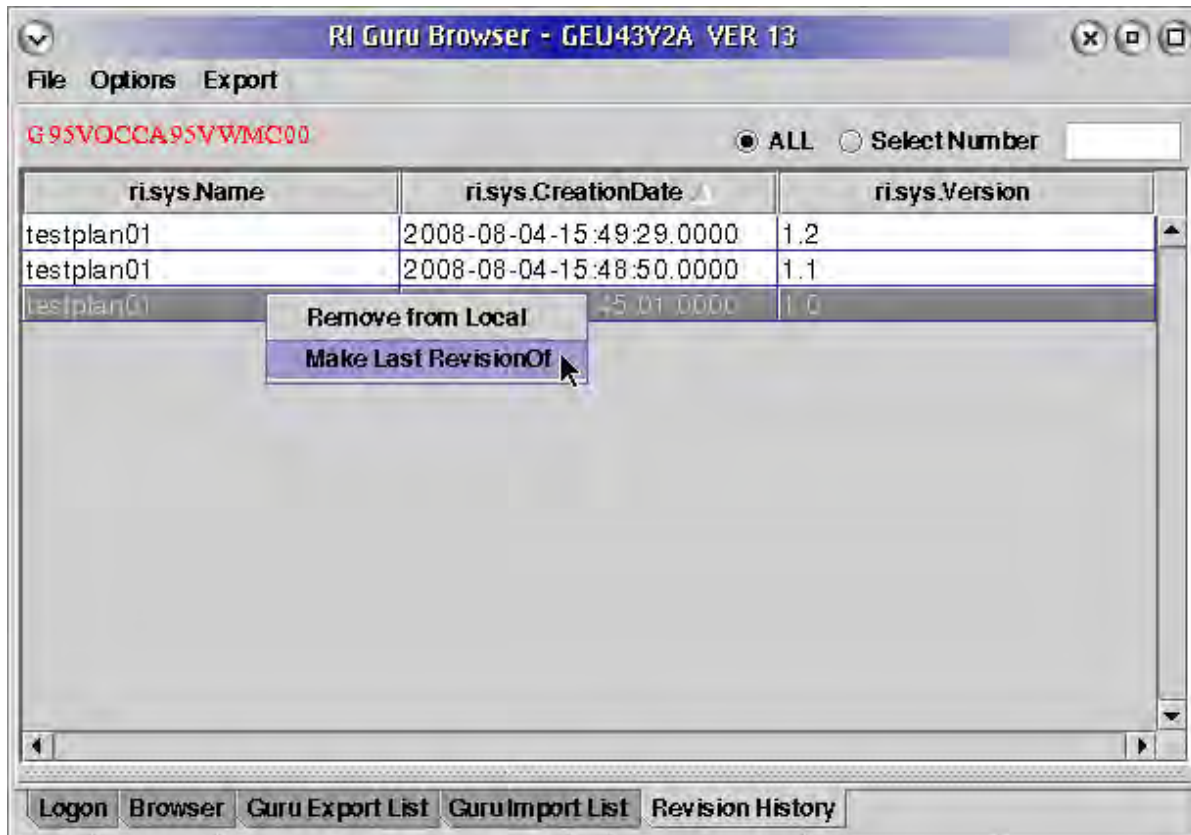


Select the desired object and select the **Revision History** tab



The window now displays the list of the available versions of the selected Guru object. Select the one to recover from, right click, and select **Make Last RevisionOf**. This step makes the selected object the latest version in Guru. **DO NOT** use this to revise application objects (i.e. use a previous version of the Device Connection Editor) without specific instructions from RI Support.

FIGURE 7.23 RECOVER A GURU OBJECT



Right click the desired version and select **Make Last RevisionOf** to make that version the latest in Guru.

© Roos Instruments Inc.

# GURU NETWORK ISSUES

The Guru Address Book Admin application allows the user to create and update Guru Server network addresses which are used to connect Guru Clients (the Cassini System Controller or Virtual Workstation) to a Guru server. After logging on to Guru, select **Apps > Guru Address Book Admin**. The user must belong to a group with "Admin" permission to see the Address Book application.

## CREATING A NEW GURU ADDRESS

Select **New Remote Address**. Enter the **Name** for this Guru address, for example, 'Update01'. Enter the host name or static IP Address of the Guru which the user wants to connect to in the **Address** field. The **Port** field should be specified as 50000. The server should be located on your local network. The **Address Type** field can be specified as "backup", "update", or "general". The "backup" type stores all of the local objects for later retrieval. The "update" type is reserved for servers that are to be checked regularly for updates. Standard configurations use the same server for both "update" and "backup" types to function properly. The "datalog" type is for transferring data logs. The "clone" type is used exclusively for

Guru Servers. The "general" and "admin" types are used for temporary connections with some Guru Apps.

When done specifying all the fields, click the **Save** button. When done adding the Guru address (es), the Guru process will need to shutdown and restarted. To shutdown the RI Guru process, select **System > Shutdown** to shutdown the RI Guru process. The RI Guru will restart automatically.

## UPDATE AN EXISTING GURU ADDRESS

Select the Guru address which the user wants to update. Select **Edit Selected**. Update all the necessary fields, then click **Save**. When finished adding the Guru address (es), the Guru process will need to be shutdown and restarted.

## REMOVING AN EXISTING GURU ADDRESS

Select the Guru address which the user wants to remove, then click **Delete Selected**. Click **OK** if the user really wants to remove the selected Guru address (es). The Cancel button will abort the deletion process. When finished removing the unwanted Guru address (es), the Guru process will need to shutdown the RI Guru process and restart it.

# 20 GHz SOURCE SELF TEST

## OVERVIEW

Subtle problems with the RI7725 20 GHz Source TIMs can be identified with Self Test.

### Execute Self Test

The test system's primary instrument diagnostics can be accessed from the Configuration Window by selecting **Tester > Diagnose** from the menu options as shown in [Figure 5.1](#). This launches the Diagnostic Executive (Exec.) and loads the factory-installed diagnostic test plans for the test system (see [Figure 5.14](#)). The diagnostic tests are listed in order of ascending instrument number and grouped by TIM.

*NOTE: Self Test is not a prerequisite for Calibration.*

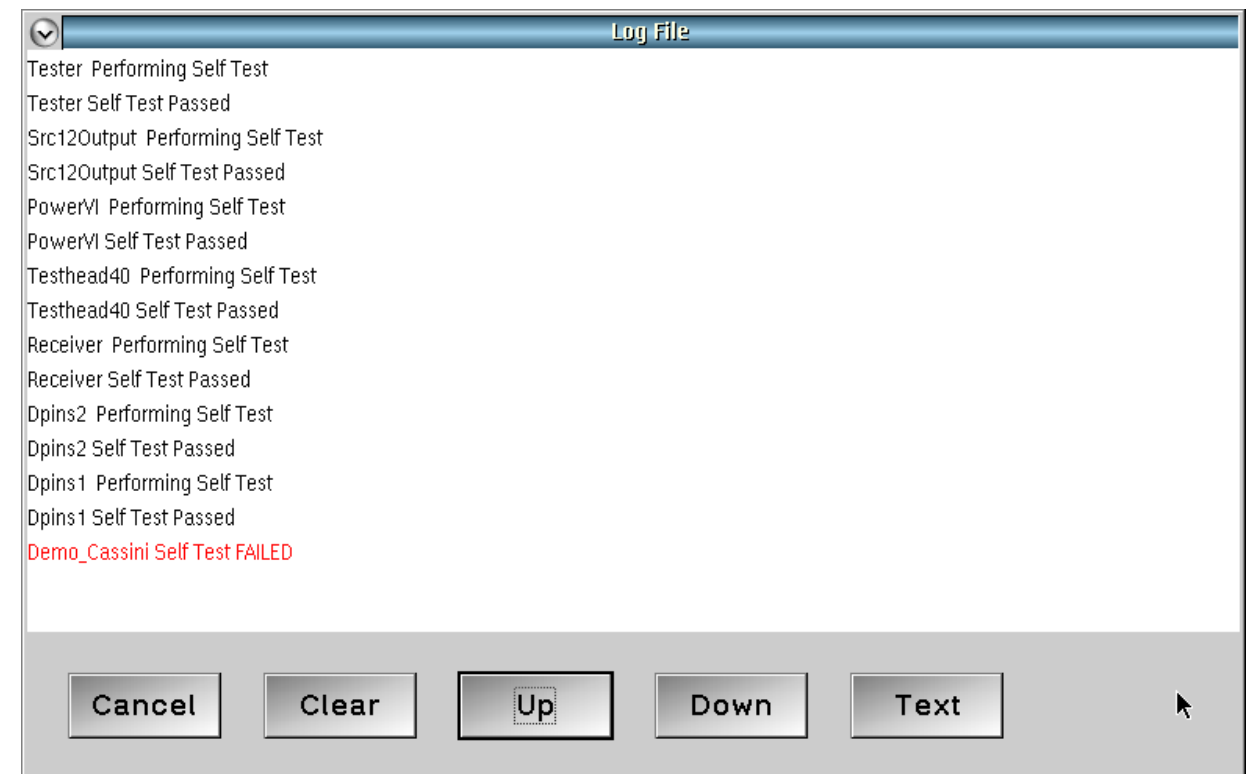
Choose **Run > Self Test** menu selection from the Diagnostic Exec window. The Self Test does not need to be run unless the 20 GHz Sources are suspected.

### Viewing Self Test Results

The results of the Self Test appears in the Message window (see [Figure 1.61](#)) instead of the Results pane. Although all instruments may include an embedded “self test”, only the RI7725 model sources have nontrivial results.

If the 10 MHz clock and internal phase lock components are functioning properly, the Message window will display “<Tester Name> self test Passed” at the end of a long list of instrument names passing their self tests. If the Message window displays “<Tester

FIGURE 7.24 SELF TEST FAILED RESULT

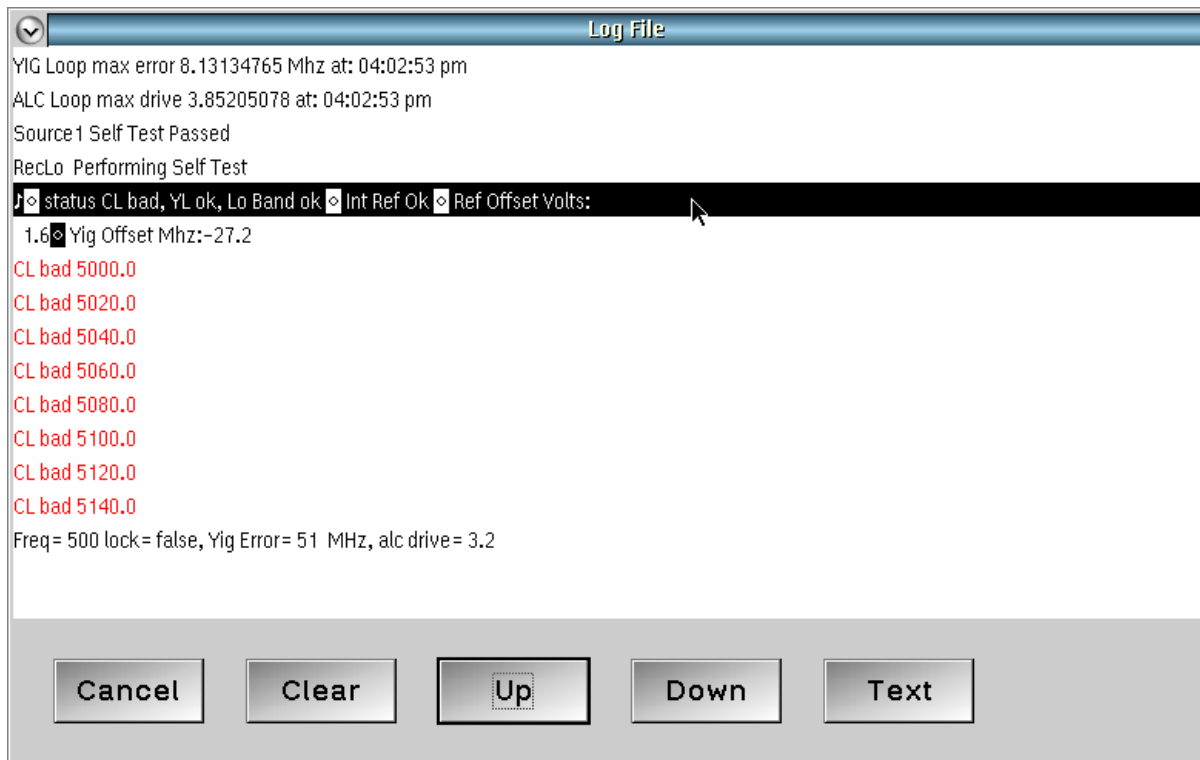


If any failure was detected, the last line displays a message with the system name followed by “Self Test FAILED” in RED.

Name> self test FAILED!” in red, then press **Text** button to see the instrument name that has an issue.

Use **File > Save** to create a file to send to RI Support to assist in resolving the issue.

FIGURE 7.25 20 GHz SOURCE SELF TEST FAILURE DETAILS



Choose the **UP** button to see the details of the Self Test failure.

# INFRASTRUCTURE POWER DISTRIBUTION

The Cassini 16 Infrastructure provides three access panels to service various parts of the Cassini infrastructure.

Contact Roos Instruments support at [support@roos.com](mailto:support@roos.com) for specific instructions for diagnosing or replacing damaged or suspected malfunction of infrastructure components. For servicing the Small Cassini or Large Cassini infrastructures, contact Roos Instruments support at [support@roos.com](mailto:support@roos.com) for instructions for diagnosing or replacing damaged or suspected malfunction of infrastructure components.

## BEFORE SERVICING ANY PART OF THE INFRASTRUCTURE:

- Exercise proper ESD procedures with the Cassini test system, fixtures, TIMs, and auxiliary equipment.
- Undock the test system from handlers or probers and disconnect any Handler/Prober or GPIB pods.
- Remove any fixtures or diagnostic/calibration plates from the test head.

- Lock the test head manipulator arm in the 'Maintenance Position.'

## BEFORE SERVICING THE INFRASTRUCTURE

### CHASSIS:

- Exercise proper ESD procedures with the Cassini test system, fixtures, TIMs, and auxiliary equipment.
- Remove any TIMs, fixture or diagnostic/calibration plate, and auxiliary equipment from the test head.
- Lock the test head manipulator arm in the 'Maintenance Position.'
- Rotate and lock the test head into the upright position.
- Follow the shutdown procedures outlined in the [Operator & Safety Information](#) section.
- Verify that the 'Main Breaker' is switched to the OFF position before performing any infrastructure maintenance.

---

**WARNING: Failure to power down the test system and set all circuit breakers to their OFF position before servicing can result in damage to components and possible injury to service personnel.**

---

## POWER SUPPLY ACCESS PANEL

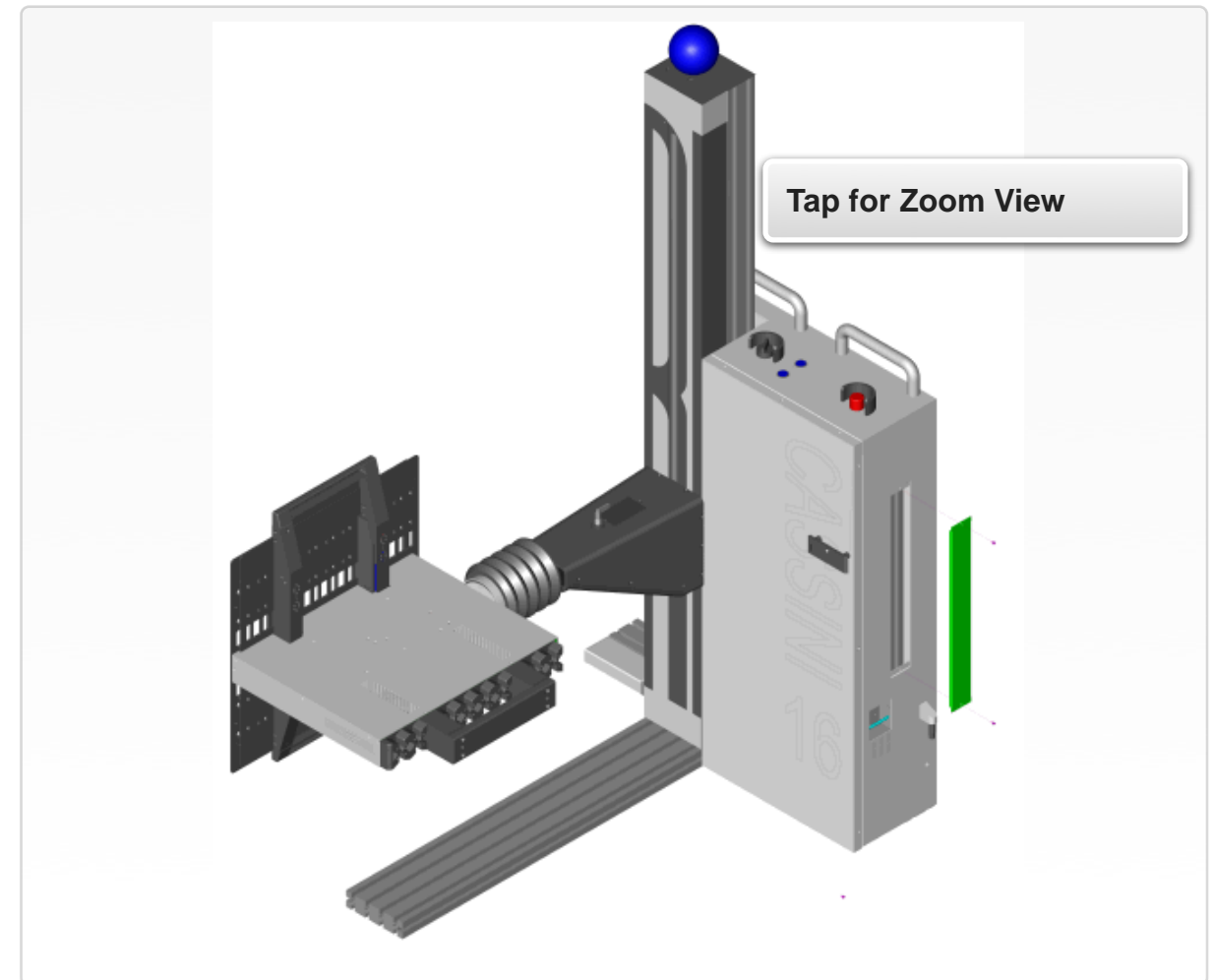
The power supply access panel, shown in [Figure 7.26](#), provides access to the AC/DC switching power supply modules. To access the supplies, remove the two 4-40 retaining screws of the panel with a #1 Philips screwdriver.

Every Cassini 16 system is configured with two power modules to provide a primary 48V supply and secondary 48V supply as a backup as shown in [Figure 7.27](#). The modules have two green status indicator lights. The upper light (closest to the mounting screw) indicates that the module is connected to AC power. The second light indicates that module is functional and producing 48V supply. These supply modules can be independently replaced as needed and should be checked in accordance with the recommended preventative maintenance schedule.

To replace a module:

1. Power down the test system in accordance with the [Shutdown procedures](#).
2. Unscrew the module's mounting screw with a #2 Phillips head screwdriver.
3. Insert the new module ([Figure 7.28](#)) in the corresponding location and tighten the mounting screw.
4. Replace the access panel and secure it with the two 4-40 screws.

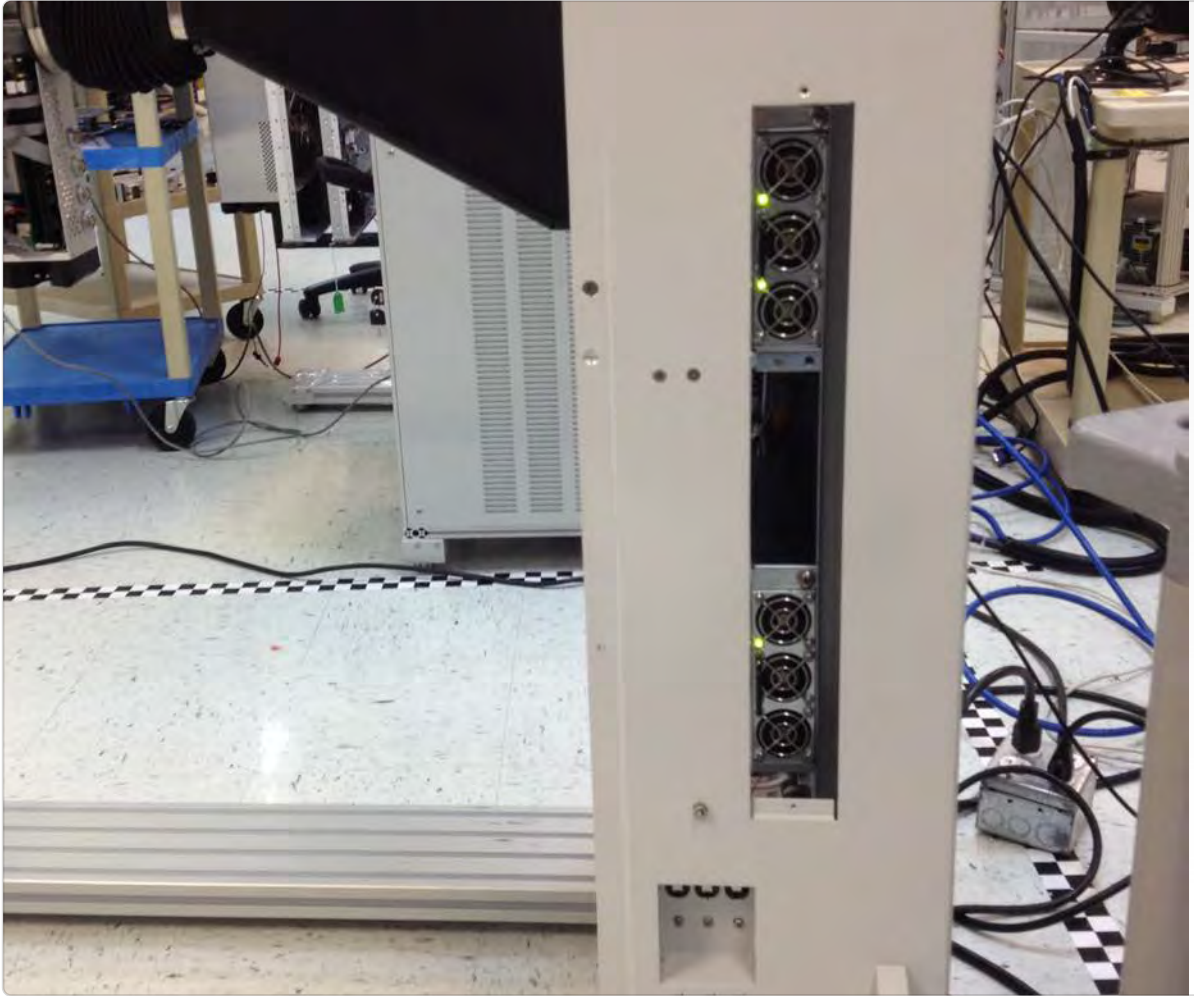
FIGURE 7.26 REMOVING THE POWER SUPPLY ACCESS PANEL



Screw locations for removing the power supply access panel are shown above. Use a #1 Philips screwdriver to remove the screws.



FIGURE 7.27 SWITCHING POWER SUPPLY MODULES LOCATION



The above pictures shows the location of the redundant switching power supply modules of the Cassini 16 test system. The two green LED lights on the top modules indicates normal operation. The lower module with only one green LED light active indicates a failed or malfunctioning module.

FIGURE 7.28 SWITCHING POWER SUPPLY MODULE



## MAINFRAME ACCESS PANEL

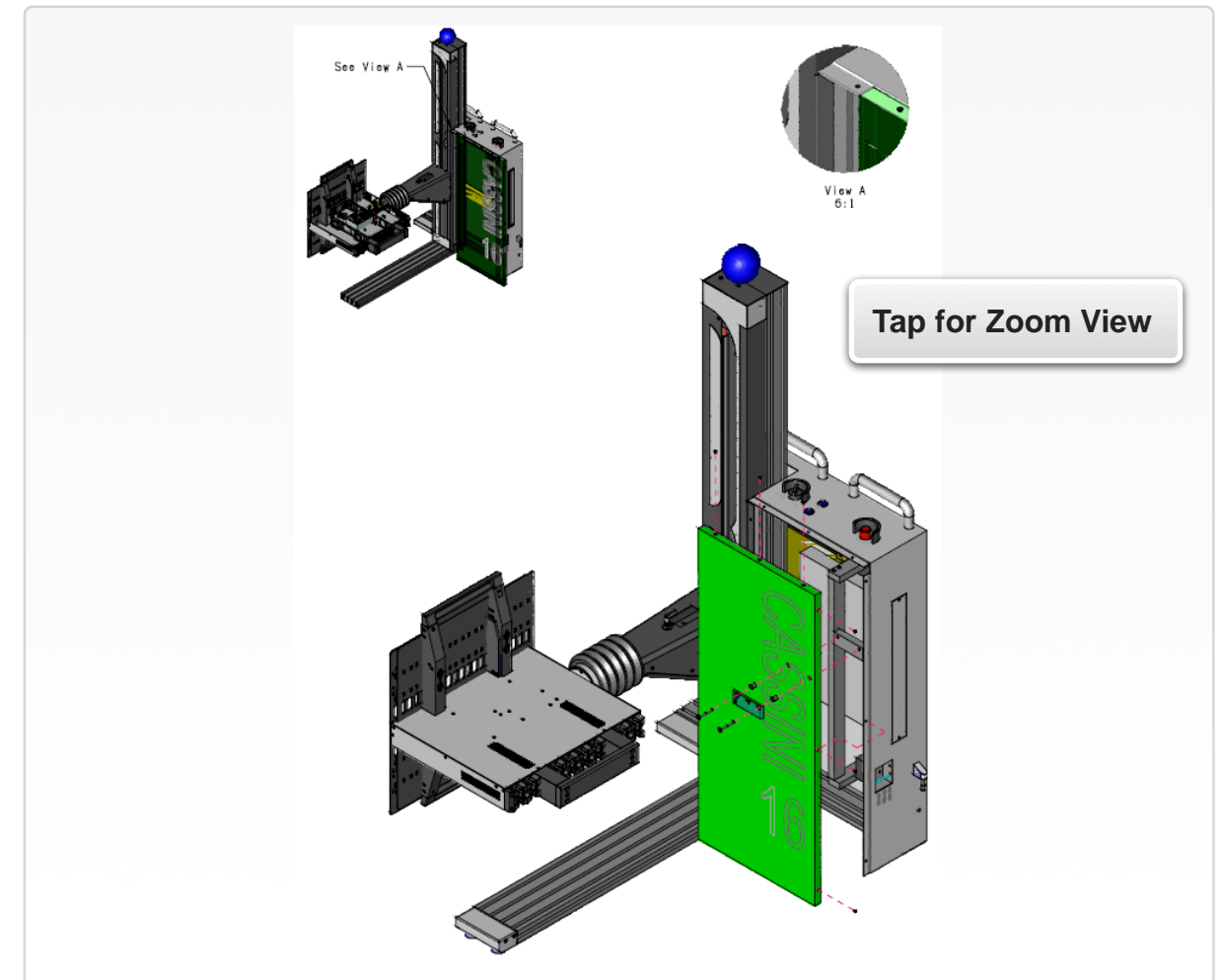
The mainframe access panel, shown in [Figure 7.29](#), provides access to the AC/DC switching power supply unit, RIFL bus, pneumatic fixture docking system's air ducts, and control boards for the manipulator's elevator lift, EMO switch, and infrastructure.

**WARNING: Never tamper with or attempt to service components in the infrastructure without support or assistance from Roos Instruments engineers or technicians.**

To access the main frame components:

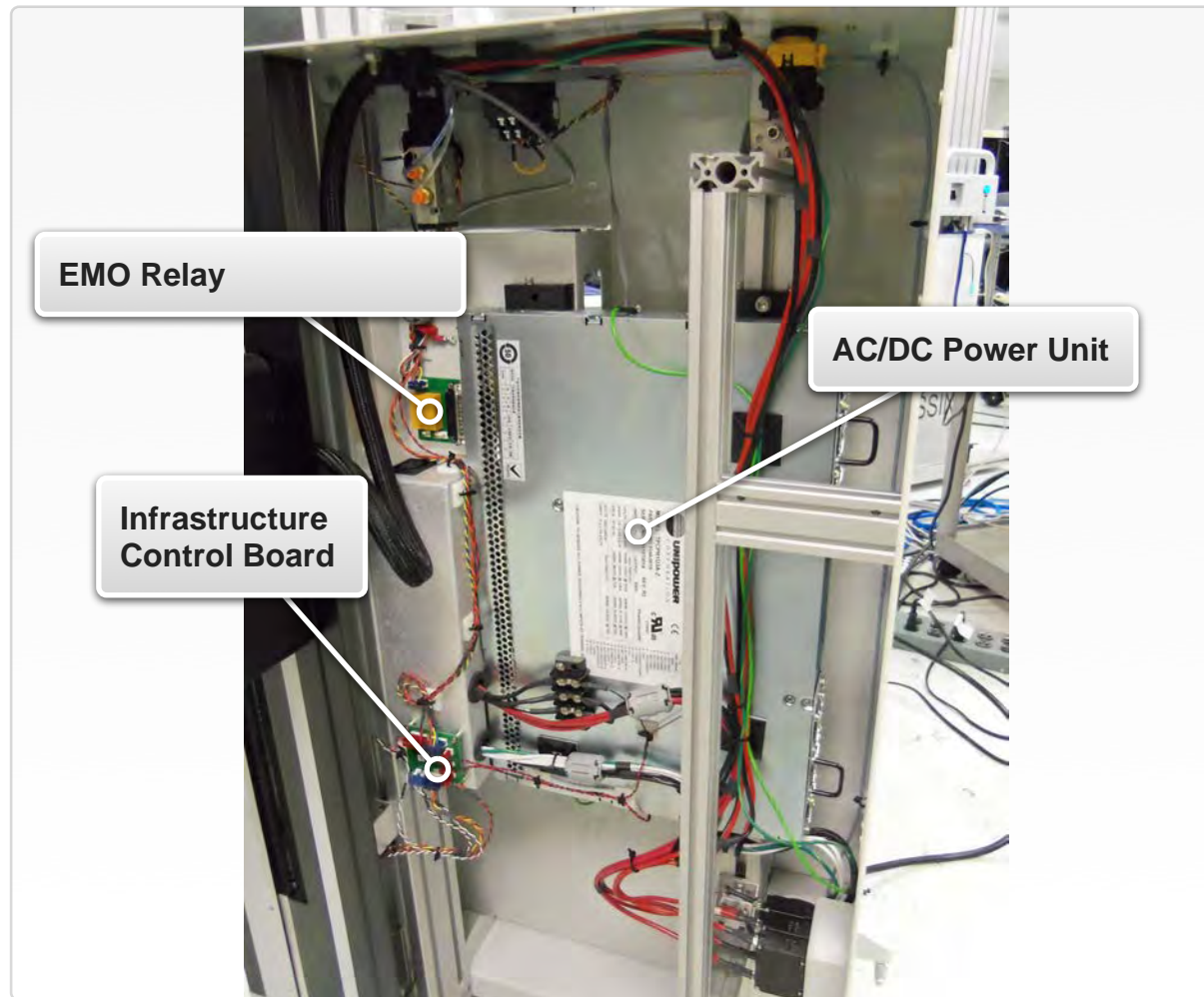
1. Unscrew the six 4-40 Philips head screws, two Allen head screws, and Auxiliary Rack mount plate from the front of the panel.
2. Slide the panel away from the chassis by pulling outward as shown in [Figure 7.29](#).

FIGURE 7.29 REMOVING THE MAINFRAME ACCESS PANEL



Screw locations for removing the mainframe access panel are shown above. Use a #1 screwdriver for removing and inserting the panel screws. Use a 5/32 in Allen wrench to remove and reinsert the auxiliary rack mount plate screws.

FIGURE 7.30 INFRASTRUCTURE CHASSIS INTERNAL VIEW



The above pictures shows the internal components of the infrastructure chassis with the mainframe access panel removed.

# TEST HEAD ISSUES

The Cassini 16 test head contains the external RIFL hub, front and rear test head RIFL hubs, 48V supply distribution, and the pneumatic/mechanical components of the fixture docking system. This section provides steps and guides for accessing and servicing the test head resources. Reference the [Block Diagram 8.11](#) for the test head wiring block diagram.

Contact Roos Instruments support at [support@roos.com](mailto:support@roos.com) for specific instructions for diagnosing or replacing damaged or suspected malfunction of test head components. For instructions on diagnosing, servicing, and replacing damaged or suspected malfunction of components of the Small Cassini or Large Cassini test head, contact Roos Instruments support at [support@roos.com](mailto:support@roos.com).

## BEFORE SERVICING ANY PART OF THE TEST HEAD:

- Exercise proper ESD procedures with the Cassini test system, fixtures, TIMs, and auxiliary equipment.
- Undock the test system from handlers or probers and disconnect any Handler/Prober or GPIB pods.

- Remove any fixtures or diagnostic/calibration plates from the test head.
- Lock the test head manipulator arm in the 'Maintenance Position.'

## BEFORE SERVICING THE TEST HEAD:

- Remove all TIMs from the test head.
- Rotate and lock the test head into the horizontal position to access the service panel and/or RIFL test head hubs as shown in [Figure 7.31](#).
- Power down the test head 48V by switching the secondary breakers to their OFF positions (Reference [Figure 1.17](#) for locations).

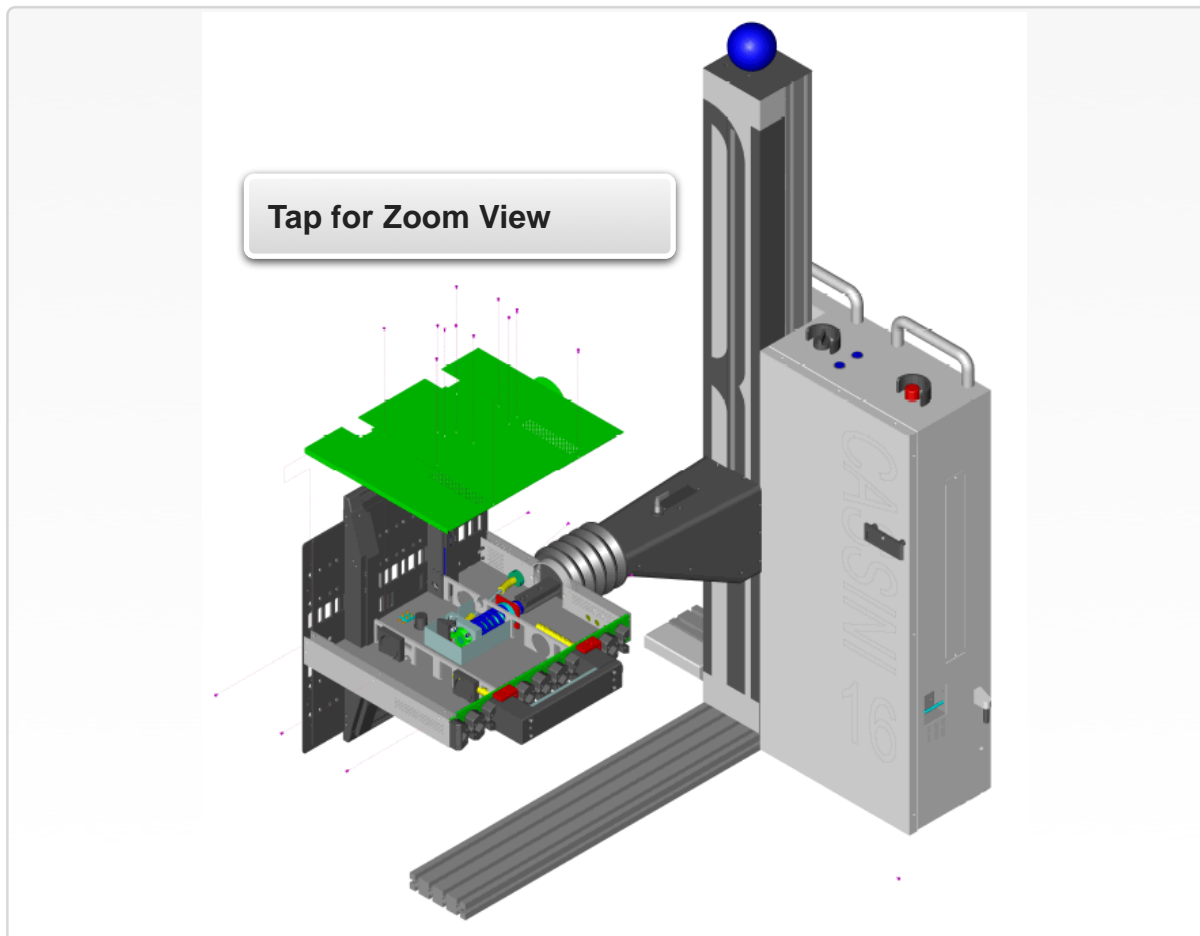
*NOTE: For early model Cassini, switch the TIM FRONT, TIM REAR, and Test Head breakers to their OFF positions to disconnect 48V from the front test head RIFL hub, rear test head RIFL hub and external test head RIFL hub located inside the test head. For late model Cassini, switch the HEAD breaker to the OFF positions to disconnect 48V from the front test head RIFL hub, rear test head RIFL hub and external test head RIFL hub located inside the test head.*

- Verify that power has been removed from the test head by checking that the ALIGN and DOCK indicator lights on the side of the test head are both off. If the indicators lights are still ON, power down the entire test system as described in the [Operator & Safety Information](#) section.



**WARNING: Failure to power down the test head before servicing can result in damage to components.**

FIGURE 7.31 REMOVING THE TEST HEAD ACCESS PANEL



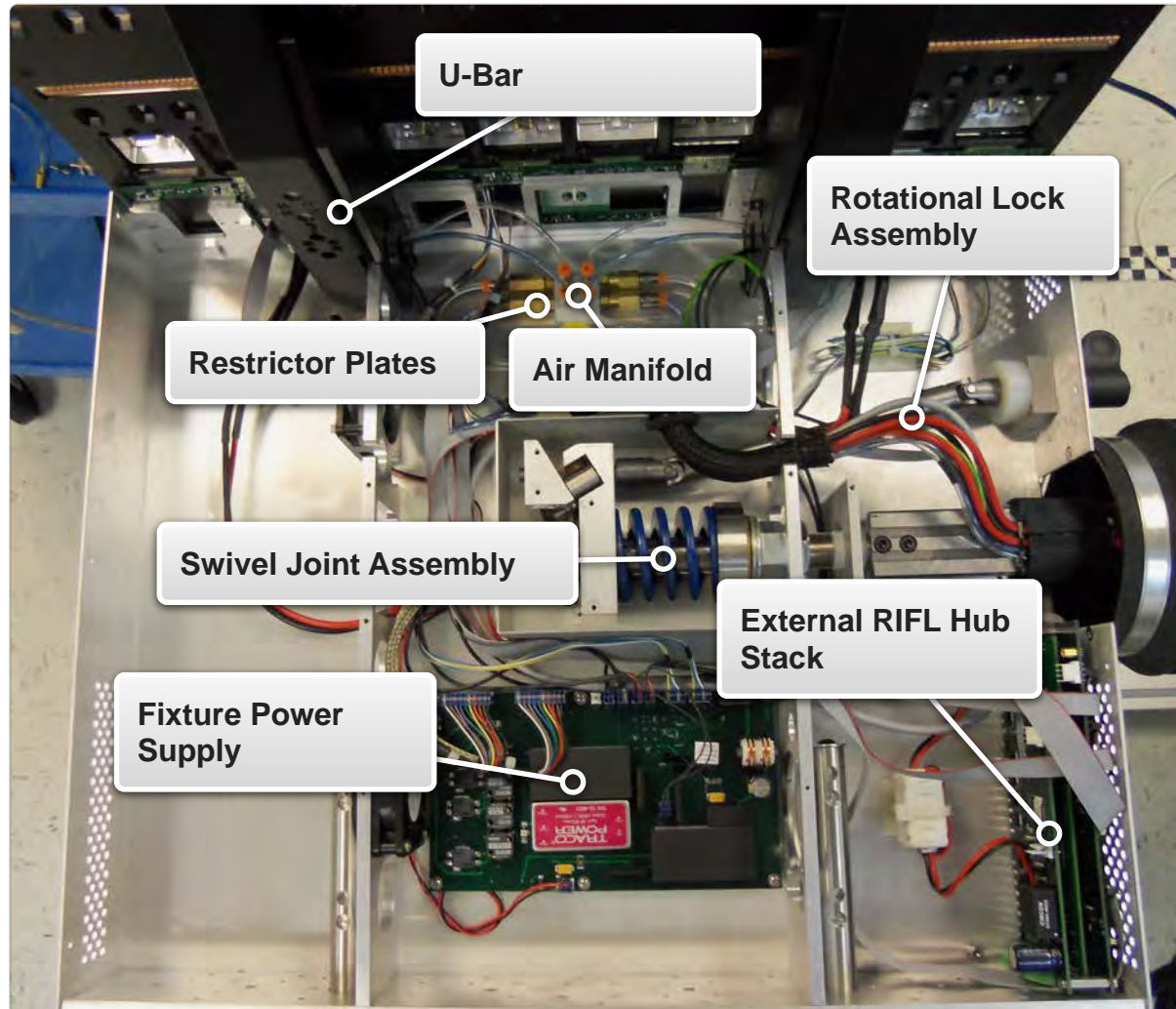
Screw locations for removing the test head access panel. Use a #1 Philips screwdriver to remove the screws.

## TEST HEAD SERVICE PANEL

The test head service panel, shown in [Figure 7.31](#), provides access to the test head internals: external RIFL hub, 48V power supply distribution, front and rear test head RIFL hubs, pneumatic fixture docking components, test head fans, and manipulator arm mechanical components. The diagram shows the location of the sixteen 4-40 type screws that must be removed from the panel to access the test head.

[Figure 7.32](#) shows the inside of the Cassini 16 test head. The swivel joint assembly connects the test head to the manipulator arm to provide pivotal movement for handler/prober docking alignment and mechanical compliance. The External RIFL hub stack distributes the RIFL bus to the front and rear RIFL test head hubs, and to the fixture power supply board to route out to the fixture RIFL interface block. The Fixture Power Supply is connected to the Fixture RIFL interface block to provide the +28V,  $\pm 15V$ ,  $\pm 5V$  power supplies and RIFL communication bus. The pressurized air supply routes from the infrastructure to the air manifold for distribution to the fixture docking system. Restrictor

FIGURE 7.32 CASSINI 16 TEST HEAD INTERIOR



The above pictures shows the Cassini 16 test head components and their functions.



# RIFL ISSUES

## OVERVIEW

Each RIFL node is checked by performing simple I/O and loopback tests. The test head contains RIFL Hubs that distribute RIFL packets between the RIFL Master in the System Controller (EPC) and any installed TIMs, Fixture Modules, and Handler/Prober/GPIB Instrument Pods. Diagnosing RIFL communication issues are done from the [Equipment Pool](#).

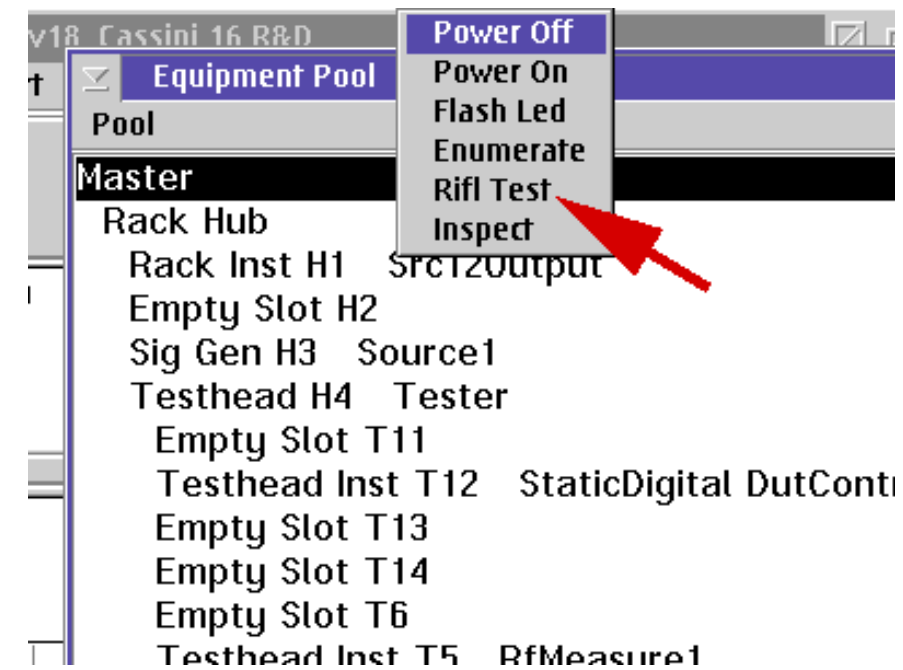
*NOTE: RIFL Diagnostic is not a prerequisite for Calibration. RIFL communications can be tested for all nodes or a specific node.*

To diagnose RIFL Master and all RIFL nodes:

1. Open the Messages window by choosing **System > Messages** from the main Cassini window. Press the **Clear** button to remove any previous messages.
2. Open the Equipment Pool by choosing **System > Equip > Nodes** from the main Cassini window.

3. Highlight the “Master” element (usually the top of the list), RMB click and select **Rifl Test** from the menu. (See [Figure](#))
4. Enter “1” in the Times to Repeat dialog and choose **OK**. Increase this number if a failure is not identified or is suspected to be intermittent.
5. The Message window displays a black “passed” message or a red “failed” message each tested node as seen in [Figure 7.34](#). Use **Less** to scroll up to see any failures that may have scrolled off the top of the Message window. If a “failed” message is displayed, choose **Text** then **File > Save** to send to Roos

FIGURE 7.33 DIAGNOSE RIFL MASTER



Choose RIFL Test from the RMB click menu from Master entry in the Equipment Pool window.

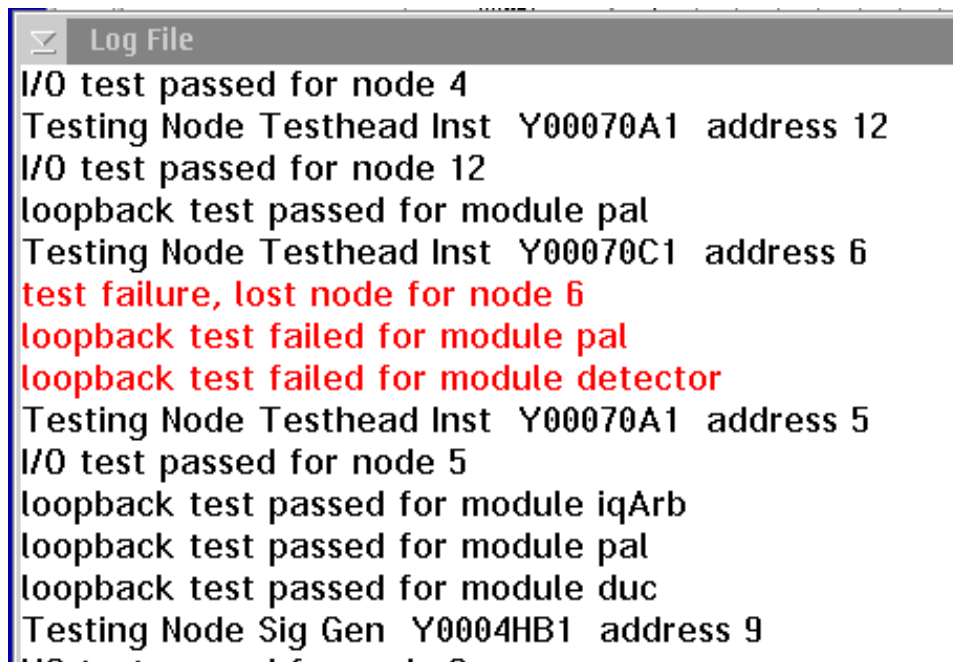
Support to resolve the issue. See [Example A](#) to help identify a failed instrument by node number.

To Diagnose a specific RIFL node:

1. Highlight the desired node from the Equipment Pool window, RMB click and select **Rifl Test**. If a Hub is selected, each attached TIM, Pod, or Fixture Module is tested.
2. Enter "1" (or more) in the Times to Repeat dialog and choose **OK**.

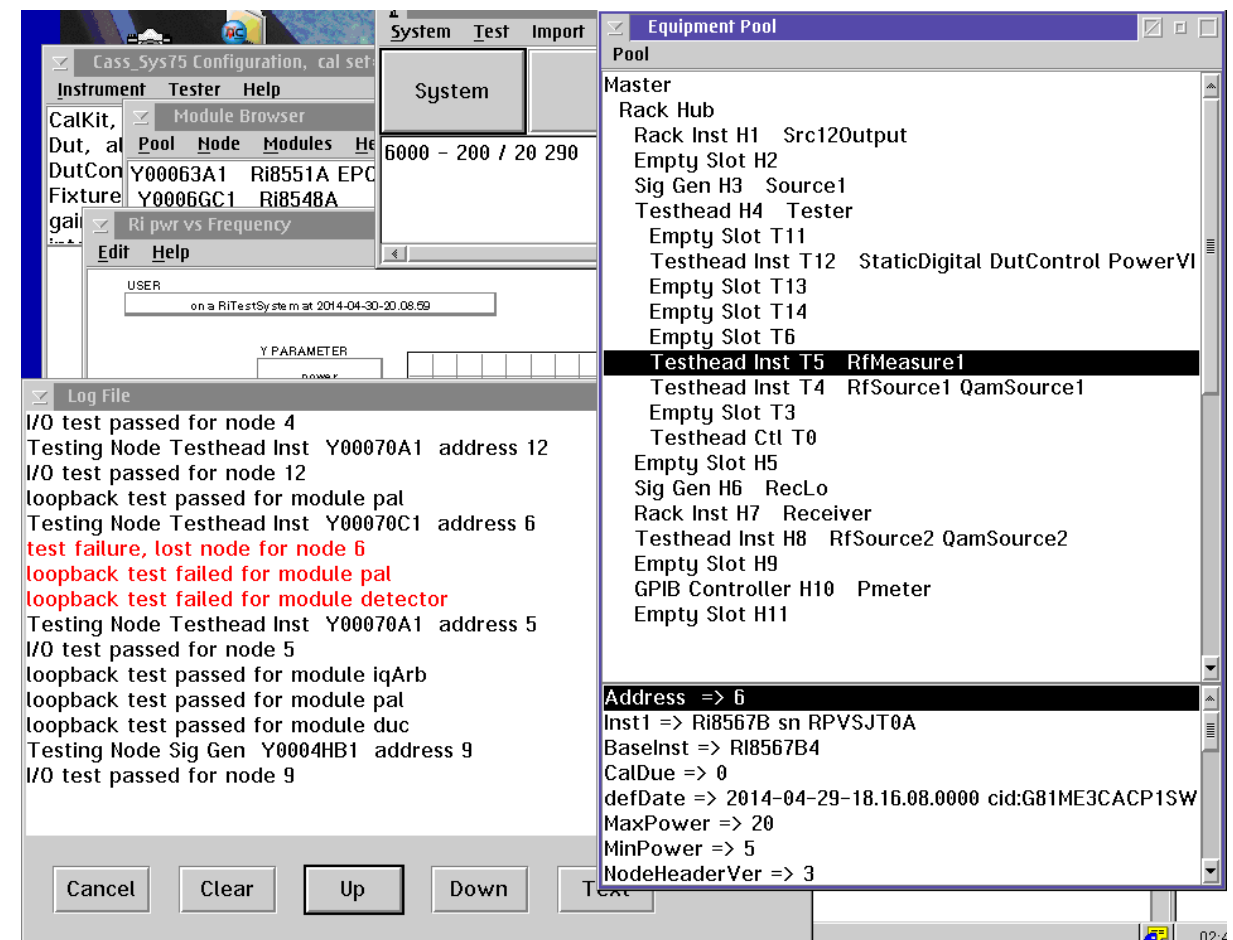
To identify which TIM corresponds to a failed node, highlight an instrument in the Equipment Pool and identify the Address in the lower pane. See [Example A](#)) showing the "Testhead Inst T5 RfMeasure1" instrument that corresponds to the failed node number "6". Nodes are assigned based on how quickly they respond to the RIFL Master and may change any time the system is started or when a **System > Start Up** is run.

FIGURE 7.34 RIFL TEST RESULTS



Failures are identified by red text in the Message window.

EXAMPLE A RIFL TEST NODE IDENTIFICATION



The failure at node 6 corresponds to the Equipment Pool Address => 6 entry which is the 'RFMeasure1' instrument in test head location T5 651

# HANDLER ISSUES

The Handler Pod is configured at the factory and has its configuration stored on the device itself. Handler Pods are available with different interface options: Parallel (RI8517A), Serial (RI8516A), or GPIB (RI8552A). Handler issues are generally resolved by checking the connection between the handler and the RI ATE System or by reconfiguring the handler. A ground wire may be necessary between the test system and the handler to prevent power spikes.

In the case of irregular handler operation, first check the RIFL cable that goes from the Handler Pod to the Handler's tester interface port for kinks or damages. Make sure that the cable is NOT a standard RJ-45 ethernet cable; it must have shielding. Most handlers have an opto-isolator built into the tester interface that needs to be connected to the tester power through the interface cable. Use a Voltmeter to verify that the required voltages are present and that all the connections are made.

Make sure the Handler and Tester are grounded to the same earth ground (same AC outlet) so that no ground potential exists between the Handler and Tester. If there is a possibility of ground potential,

connect a 16 gauge or higher ground wire from the Handler Chassis to the System's rack.

To test a Handler Interface Pod, connect the pod, using the supplied RIFL III cable, to the connector on the test head and the handler to the pod with the custom handler cable.

From Cassini select **System > Equip** to open the Equipment Pool window.

From Equipment Pool window, select **Nodes > Pool > Control Modules** to open the Module Browser window.

In the Module Browser window find and highlight the Handler Interface Module. It should look like, "RiXXXX Name" (Name would be the name of the handler e.g. "Delta"). In the middle section highlight "Handler". In the lower section there are 3 boxes in the lower left. These will be used to control the Handler pod signals and provide a way to test the control logic with the Handler attached.

## HANDLER POD TROUBLESHOOTING

If the user does not have a RI Monitor Handler Interface (M6XHRF1A), the user can check bins 1 and 2:

1. Send a Bin and EOT signal to the handler by selecting the box marked "PULSE BIN".
2. In the "Choose" window, select a Bin (1 or 2).
3. The Bin and EOT lights should flash.

If the user does have a RI Monitor Handler Interface (M6XHRF1A), it's possible to check the bins:

1. Connect the Monitor Handler Interface.
2. Send a Bin and EOT signal to the handler by selecting the box marked "PULSE BIN".
3. In the "Choose" window, select a Bin.
4. Watch for the Bin and EOT lights flash on the Monitor Handler Interface (and on the handler pod for bins 1 and 2).

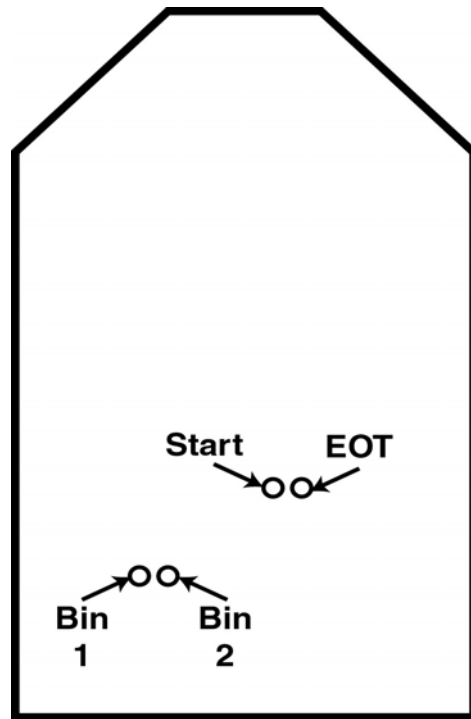
If a start signal can be sent to the handler pod, it's possible to test if the handler is sending a start test signal to the Roos system using the box marked "WAITFORSTART". To use this feature click on the box. In the "Choose" window, select a Bin. This Bin number will be sent from the tester to the handler after the handler pod receives a 'start test' signal from the handler. Enter 1 for "How many to run". The tester will now display in the main message window "waiting for start" and wait for a 'start of test' signal from the handler. When tester receives a 'start of test' signal it will send the selected Bin and EOT to the handler.

## CONNECTIONS FOR RI 8503A0 HANDLER INTERFACE

25 Pin Female D Sub type

Pin	Function	Circuit Type
1	Bin1	Open Collector Output
2	Bin2	Open Collector Output
3	Bin3	Open Collector Output
4	Bin4	Open Collector Output
5	Bin5	Open Collector Output
6	Bin6	Open Collector Output
7	Bin7	Open Collector Output
8	Bin8	Open Collector Output
10	Start Test	TTL Input
11	+V(H)	Handler +V for Pull Up <sup>1</sup>
12	GND	Ground
13	+5V	System +5V
14	RI8503A0 is +5V	System +5V
15	Input2	Misc TTL Input, Not Used
16	Input3	Misc TTL Input, Not Used
17	Input4	Misc TTL Input, Not Used
22	Bin9	Open Collector Output
23	Bin10	Open Collector Output

FIGURE 7.35 HANDLER POD TROUBLESHOOTING



*NOTE: Pin 11 must be connected to the +V from the handler, Pin13, Pin 14.*

## GPIB ISSUES

- GPIB cable length limit (4 Meters)
- Don't extend GPIB cables to make a longer run
- Instrument made "inactive" if it fails at Startup
- GPIB instruments must have a unique address
- GPIB address must match stored address in Tester software object

If there are any non-RI instruments that have been added to the RI ATE System that are controlled through the general purpose GPIB bus, an inspection of the connections should be routinely made. These types of instruments have a tendency to be a shared resource and therefore the probability of an error being introduced is greater every time the instrument is reconnected. When a GPIB instrument is selected to be available to the system, a system startup should be executed to check if the instrument is connected correctly and it's GPIB address is correct. If there is any issue with the GPIB programming of the instrument, it will be marked "Inactive" and a warning message will be placed in the Message Window.

If there is a GPIB issue always check:

- The GPIB Address
- That there is no "Daisy Chain" of the GPIB Cables
- The correct driver was selected

The following list shows the basic thoughts to always keep in mind when troubleshooting the Cassini Test System.

1. Is the problem in the source path or receive path?
2. Does the problem:
  - Change with respect to frequency?
  - Change with respect to power?
3. Problems are commonly compounded

- One problem can cause multiple failures
- Be sure to look for the right problem

4. When troubleshooting, the following steps should be taken.

- Run Diagnostics (all of them)
- Review failed data
- Look for patterns (only 1 port, direct receive path, etc.)
- Pull up test plan
- Rename to 'Junk'
- Set breakpoint
- Run to breakpoint
- Open Controller
- Manipulate settings through controller
- Begin 'halving' signal path
- Isolate bad component

To diagnose RF problems, it is necessary to run all the tests, then look for the patterns in the failures. For example, if a problem occurs at RF3, but not RF2, 6, or 7, then the problem must be in some area that's unique to RF3. If the problem occurs at RF2, 3, 6, and 7, then the problem must be with something that is common to all those

ports. Using this process of elimination, it is possible to diagnose the problem to a couple of possibilities before connecting any test equipment.



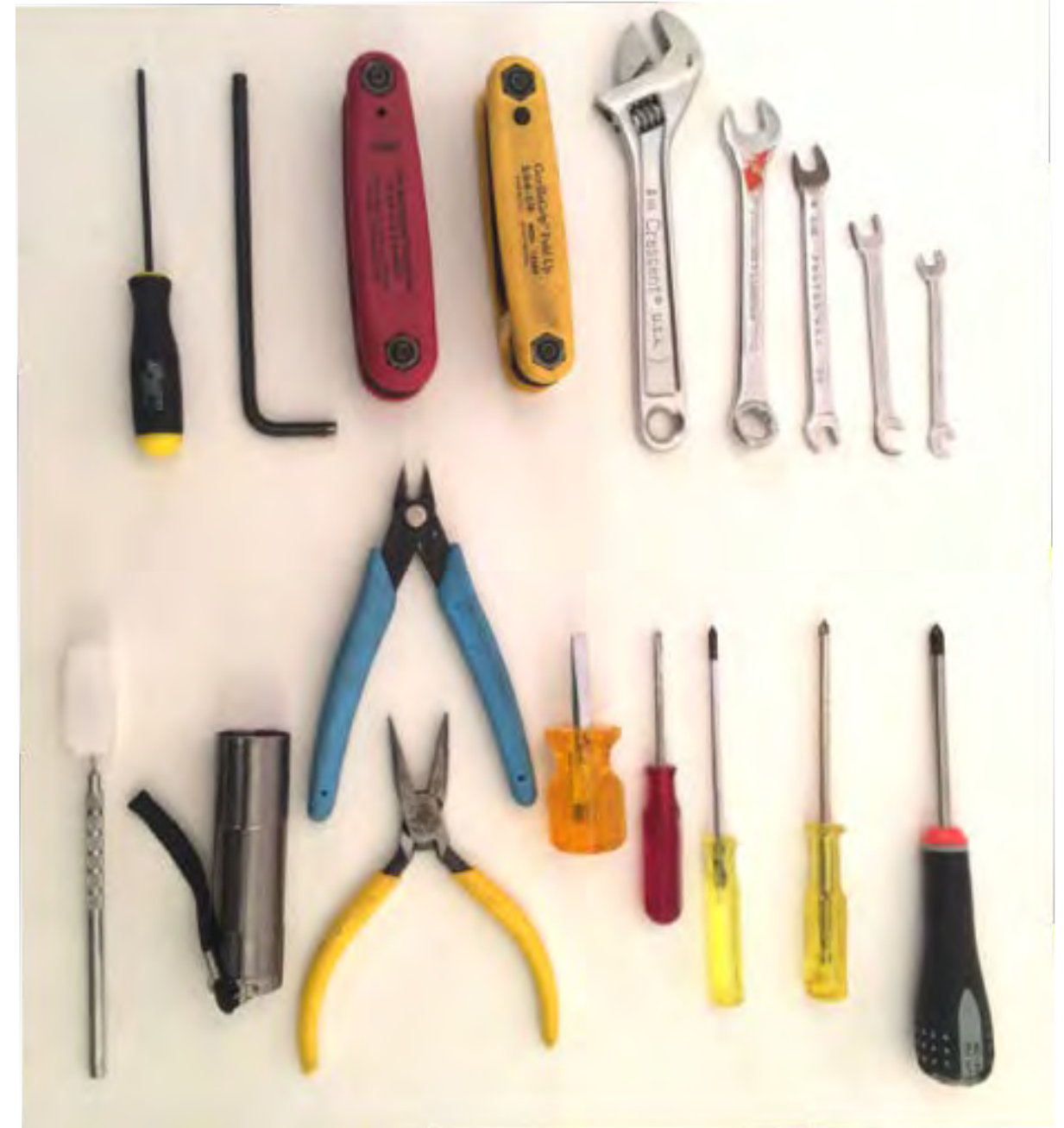
# MODULE REPAIR TOOLS

## EXAMPLE TOOLS REQUIRED AT FACILITY

The following standard tools may be required to clean connectors or repair TIM modules and are not included with Diagnostic Kit or Calibration kit. (See [Figure 7.36](#))

- 5/16 inch SMA Torque Wrench set to 7–10 in·lb (0.8 to 1.1 N·m) (See [Figure 7.37](#))
- Crescent Wrench Set (**ISO Metric** and/or **ANSI Imperial**)
- Allen Wrench sets (ISO Metric and/or ANSI Imperial)
- Phillips head Screwdrivers (ISO Metric and/or ANSI Imperial)
- Flat head Screwdriver
- Pliers (needle nose)
- Wire Cutters
- Flashlight
- Sharp Pointed tool (pick)

FIGURE 7.36 EXAMPLE TOOLS REQUIRED AT FACILITY



Example of tools that should be available at the facility and not provided by Roos Instruments. These tools may be required to clean connectors or field repair TIMs.

## SMA TORQUE WRENCH

A SMA Torque Wrench is required to attach SMA and K (2.9mm) type RF cables to various instruments during calibration. The torque wrench should be set to 0.8-1.1 N·m or 7-10 in·lb. See [Identifying SMA and K \(2.9mm\) Connections](#) for more information about the similar connection types.

---

**WARNING: Over-tightening a SMA or K connection could permanently damage the connector. Under-tightening a SMA or K connection can affect performance.**

---

---

FIGURE 7.37 5/16 INCH SMA TORQUE WRENCH



SMA Torque Wrench should be set to 0.8-1.1 N·m or 7-10 in·lb

# APPENDIX

---

**This section provides TIM:**

- **Descriptions**
- **Dimensions and Locations**
- **Block Diagrams**
- **Software Instruments**
- **Performance Specifications**
- **Endnotes**

# RI7725: 0.01 TO 20GHz MICROWAVE SOURCE



## DESCRIPTION

The RI7725 Microwave Source is a signal generator that produces sinusoidal signals from 10 MHz to 20 GHz. The RI7725 provides microsecond switching speed, high output power, low phase noise, and excellent spectral purity sine wave signals. The source provides +23 dBm at 20 GHz with -86 dBc/Hz phase noise at 10 kHz offset. The RI7725 requires the use of a remote TIM to route signal resources from the auxiliary rack to the Test Head.

## KEY FEATURES

- 100 dB Dynamic Signal Range
- Microsecond Frequency Hopping & Settling

## INSTRUMENTS PROVIDED BY THIS TIM

The instrument in this TIM appear as “Source1”, “Source2”, “Source3” in the panel dialog windows. This instrument can also be used as the Local Oscillator (L.O.) for the system’s Receiver, identified as “RecLO”

Model and Name as it appears in the Tester Configuration:

- Source1, RI7725x .01 - 20 GHz Rf source

*NOTE: The “1” in Source1 represents the enumeration of the RI7725 in the system configuration. Multiple RI7725 instruments are enumerated incrementally by the system as “1”, “2”, “3”, etc., in the configuration, edit, and control panels (i.e - Source1, Source2, Source3, etc.). The “x” in RI7725x denotes the model revision number.*

## TIM LOCATION

The RI7725 is located in the Auxiliary Rack and uses an auxiliary rack TIM, also referred to as a Remote TIM, to route resources to the test head. Remote TIMs are typically placed closest to the Auxiliary Rack (slots T1, T2, T15, T16). In a typical application, the source resources are routed via RF semi-rigid interconnect cables on the fixture bottom plate or interface plate to Test Set and/or Receiver TIMs.

*NOTE: Always calibrate the named paths after modifying the layout (bends) in the cable to maintain maximum signal fidelity.*

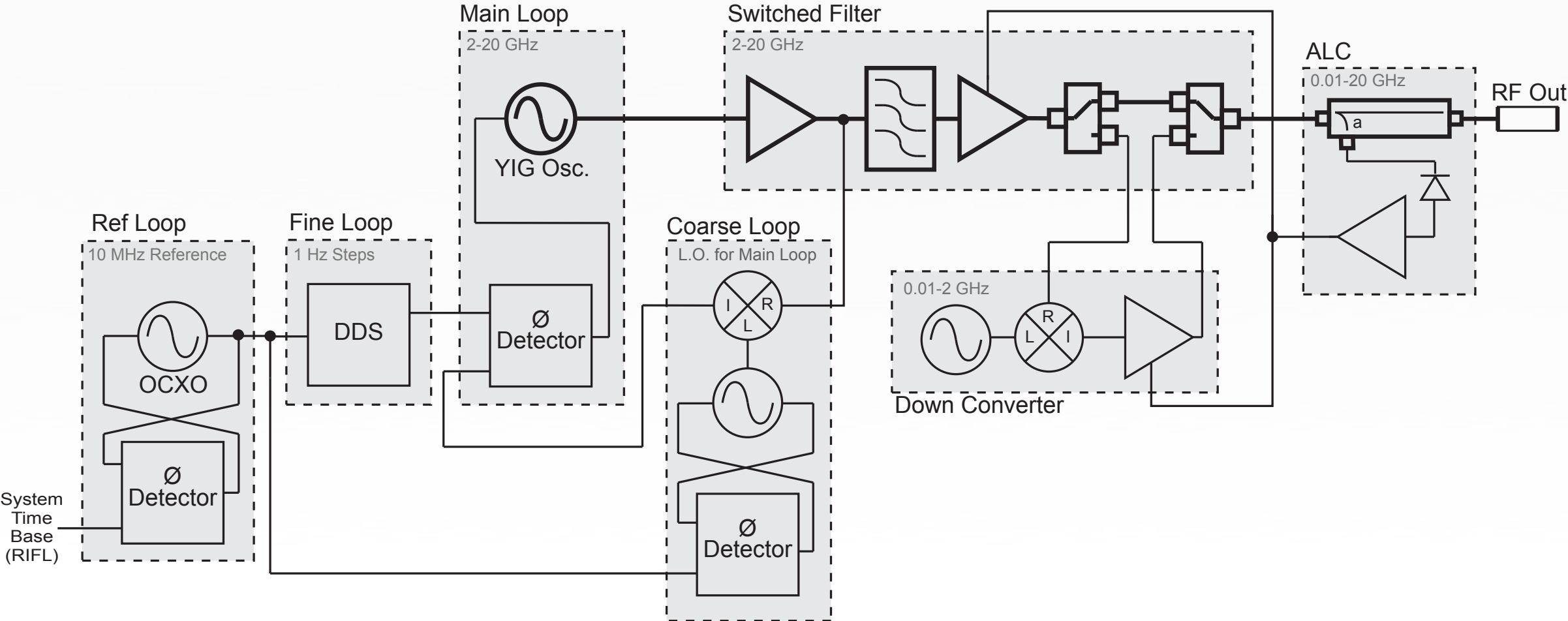
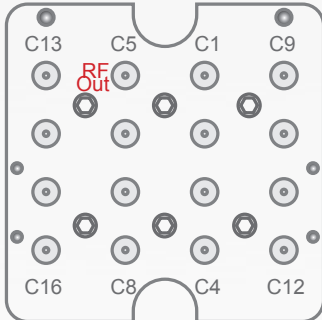
## TIM OPERATIONS

Reference the [RI7725 section](#) of the Graphical Programming chapter for configuration, edit and control panels.

BLOCK DIAGRAM 8.1


**Roos Instruments, Inc.**  
**Block Diagram, 20 GHz Source TIM**  
**RI7725C**  
 2014-02-12  
 Copyright Roos Instruments, Inc.  
 Subject to change without notice

Tap for Zoom View





## PERFORMANCE SPECIFICATIONS

### Source

---

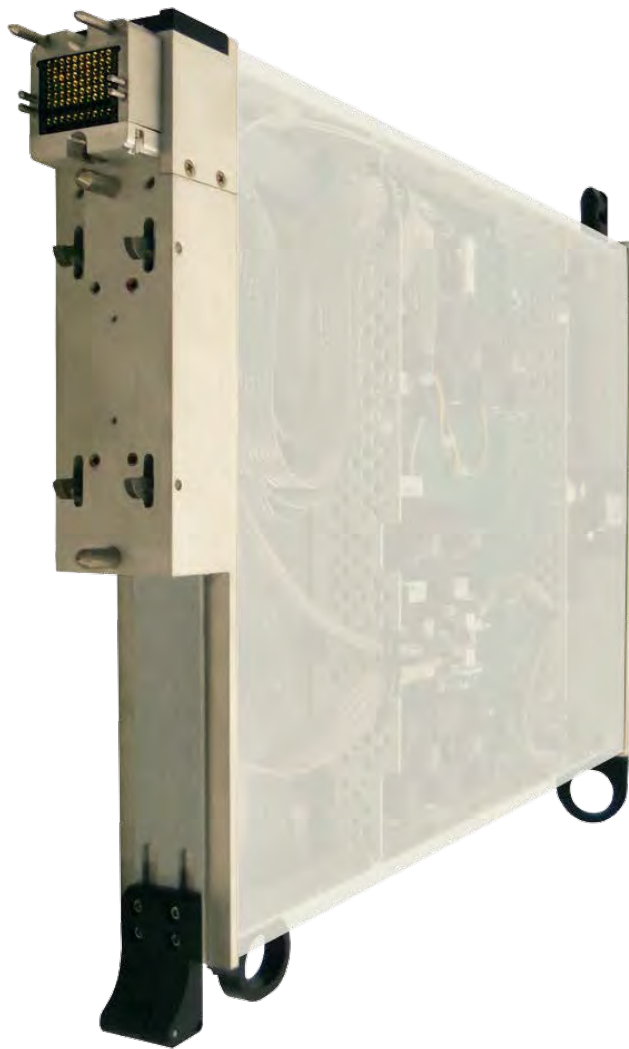
Frequency Range	10 MHz to 20 GHz
Frequency Resolution	1 Hz
Power Range <sup>2</sup>	-25 dBm to +3 dBm
Power Accuracy <sup>2</sup>	± 0.1 dB

---

This is an abbreviated list of instrument capability and is subject to change without notice. For comprehensive and up-to-date instruments specifications consult the TIM Specification document.

<sup>2</sup> Typical performance with an RI8587 Receiver

# RI8508: RF MODULATED SOURCE



## DESCRIPTION

The RI8508 RF Source provides two dedicated signal ports of modulated signal generation for applications in the 100 kHz to 6 GHz band. The instrument features a precision Quadrature Digital Upconverter (QDUC) that delivers over 100 dB of dynamic range for high-performance, complex baseband modulation from 100 kHz - 400 MHz. The 140 MHz to 6 GHz RF source supports Continuous Wave (CW) tone generation, frequency hopping, and complex carrier modulation up to 80 million samples per second with 14 bits of precision. With built-in RF switching and calibrated signal paths, the RI8508 delivers power-corrected signals and seamless modulation capability across the entire 100 kHz to 6 GHz band for maximum application flexibility.

## KEY FEATURES

- 100 dB Dynamic Signal Range
- 10 Million Sample/Symbol Modulation Rate
- Microsecond Frequency Hopping & Settling
- Modulation Pattern Import Tools

## INSTRUMENTS PROVIDED BY THIS TIM

The subset instruments in this TIM appear as **QamSource1** and **RFSource1** in the panel dialog windows.

Model and Name as it appears in the Tester Configuration:

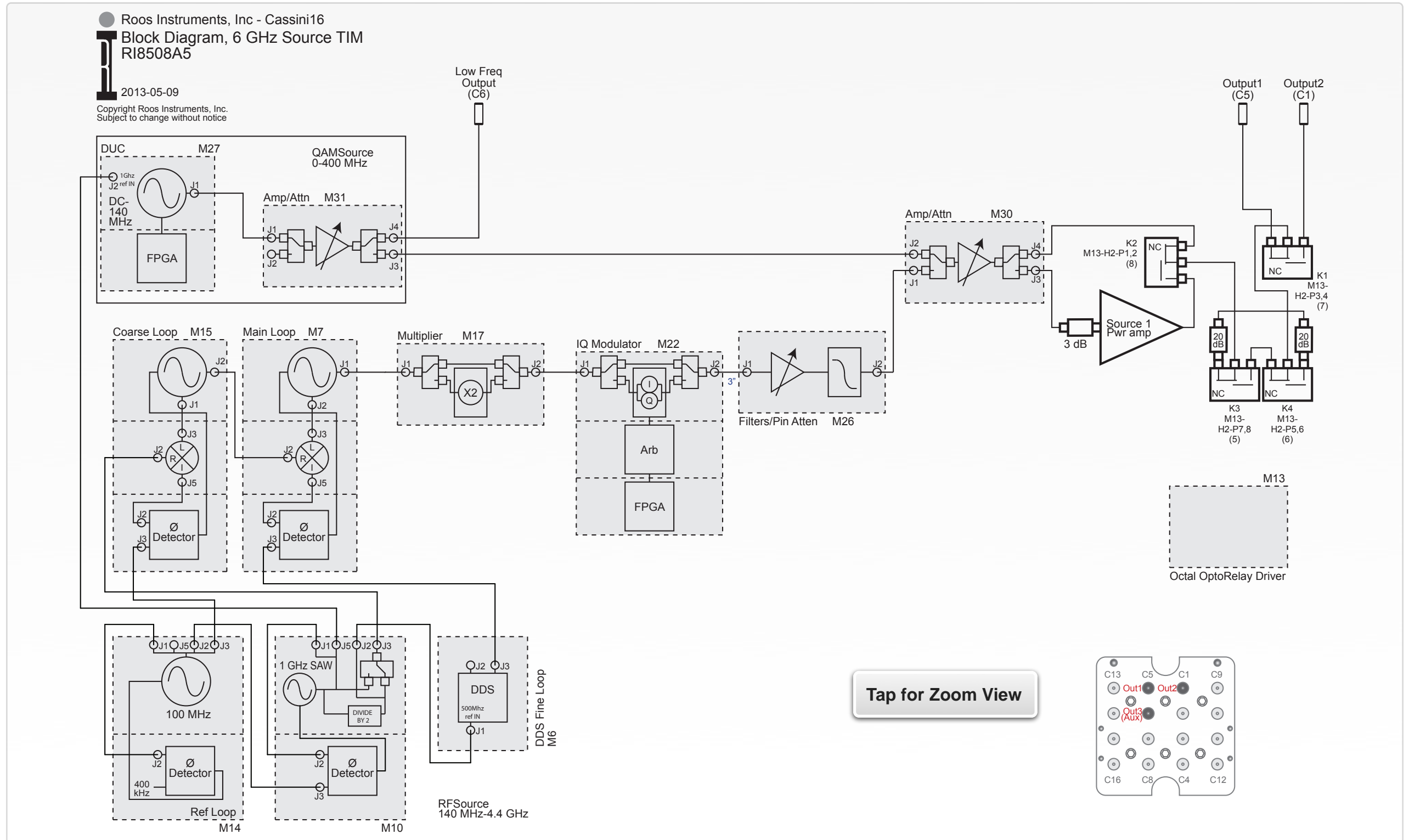
- QAMSource1, Ri74212x QAM Generator
- RFSource1, RI8508x .1 - 6GHz Rf Source

*NOTE: Multiple RI8508 instruments are enumerated incrementally by the system as “2”, “3”, etc. in the configuration, edit, and control panels (i.e - RFSource1, QAMSource1; RFSource2, QAMSource2 ; RFSource3, QAMSource3 ; etc). The “x” in RI8508x denotes the model revision number.*

## TIM OPERATIONS

Reference the [RI8508 section](#) of the Graphical Programming chapter for configuration, edit and control panels.

BLOCK DIAGRAM 8.2



## PERFORMANCE SPECIFICATIONS

### RF Source

---

Frequency Range 140 MHz to 6 GHz

Power Range -100 dBm to +14 dBm / +20 dBm (CW)

### QAM Source

---

Frequency Range 100 kHz to 400 MHz

Power Range -100 dBm to +10 dBm

Clock Rate 80 MHz

### IQ Modulator

---

Modulation Rate 80 Msps

Analog Bandwidth 5 MHz

---

This is an abbreviated list of instrument capability and is subject to change without notice. For comprehensive and up-to-date instruments specifications consult the TIM Specification document.

# RI8535: UNIVERSAL DIGITAL



## DESCRIPTION

The RI8535 Universal Digital instrument provides a complete digital subsystem with configuration options of 40, 80, or 120 synchronous pins. The instrument architecture uses dedicated digital cores for native Vector, Scan, I2C, SPI and JTAG protocols. Every pin also incorporates parametric test capability for fundamental voltage and current measurement, continuity, and frequency counter.

Comprehensive integration with Cassini's test development software brings protocol-aware programming and device interaction with register and data format support for WGL, CSV, TP, and Verilog files.

## KEY FEATURES

- Device Control with Digital Protocol Engines
- Pattern Import and Logic Analysis Tools
- Pattern Generation on the Fly
- Native JTAG Support



## INSTRUMENTS PROVIDED BY THIS TIM

This TIM provides digital pins in banks of 20 up to a possible 120 depending on the model. The instruments in this TIM appear as **DPins1**, **DPins2**, ... **DPins6** in the panel dialog windows. A 16 slot Cassini can hold up to 16, 120 pin RI8535 Universal Digital TIMs, providing up to 1,920 digital pins.

Additional TIMs appear as DPins1\_#, where the “\_#” represents the 2nd, 3rd, etc... TIM. The Owner Names will be referred to a DPins2\_1, ... DPins6\_16

Model and Name as it appears in the Tester Configuration:

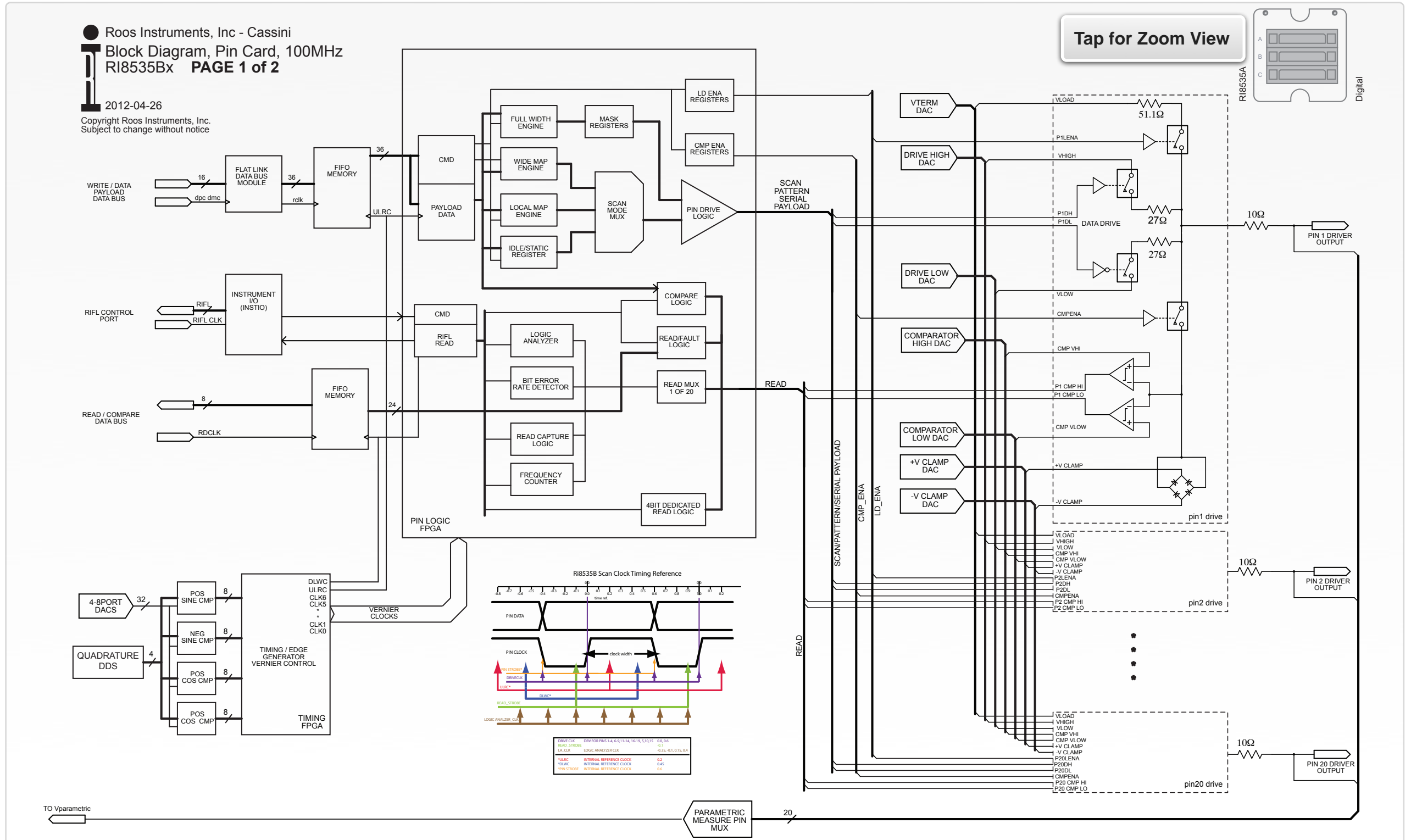
- Dpins1, Ri8535x Cassini Digital D1
- Dpins2, Ri8535x Cassini Digital D2
- etc...

*NOTE: The “1” is replaced with a “2” or “3”... depending on how many pin cards (40, 80, 120) are loaded in each TIM. If there are more than one Dpins TIM in the configuration, then an underscore followed by the TIMs (2-16) number is appended to the Owner Name. (DPins1\_2, DPins2\_2, etc.) The “x” in the model number denotes the revision of the Instrument.*

## TIM OPERATIONS

Reference the [RI8535 section](#) of the Graphical Programming chapter for configuration, edit and control panels.

BLOCK DIAGRAM 8.3 1 of 2



BLOCK DIAGRAM 8.4 2 OF 2

Roos Instruments, Inc - Cassini  
 Block Diagram, Instrument Block  
 RI8535Bx PAGE2 of 2

2012-04-26  
 Copyright Roos Instruments, Inc.  
 Subject to change without notice

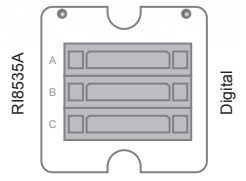
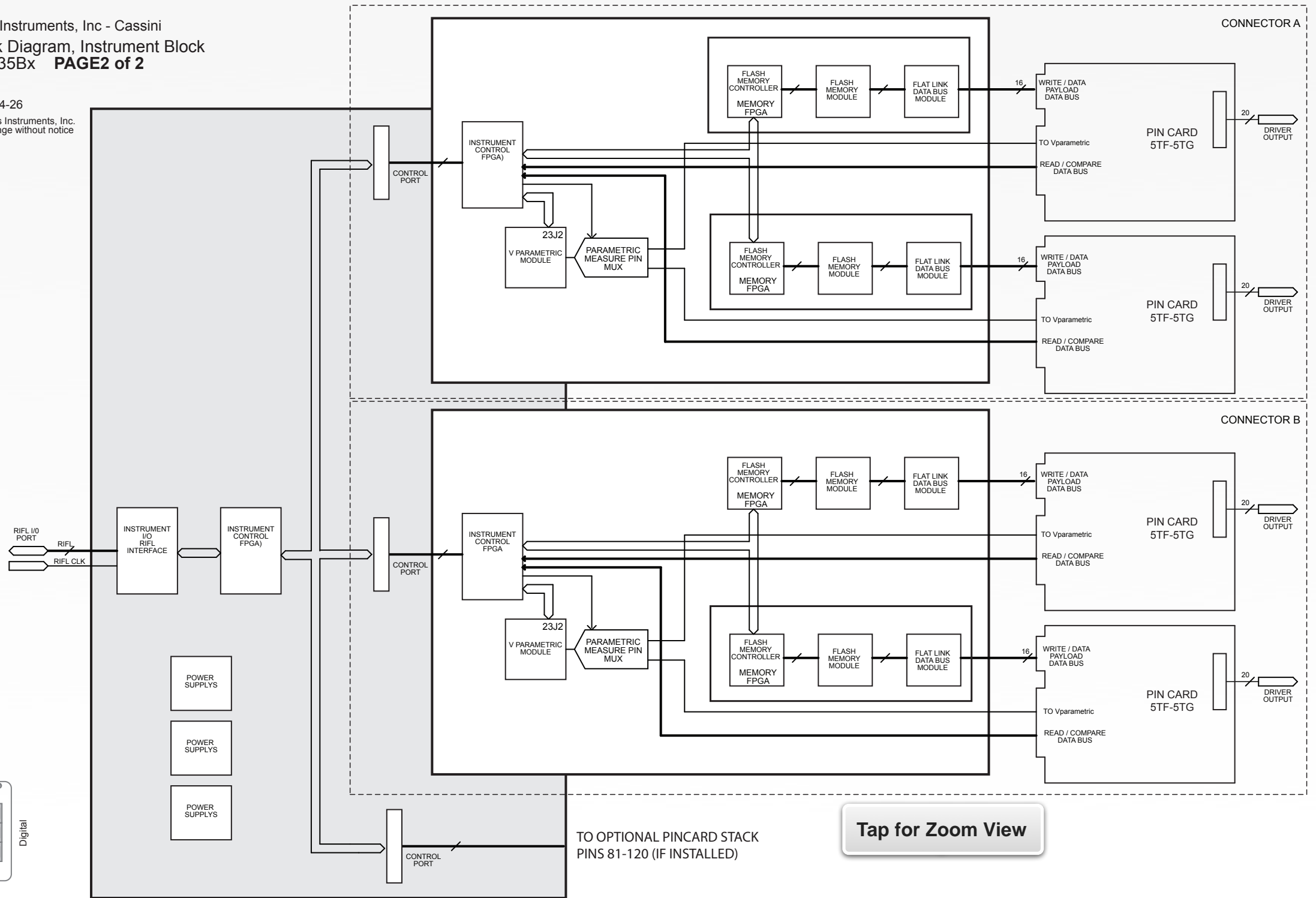
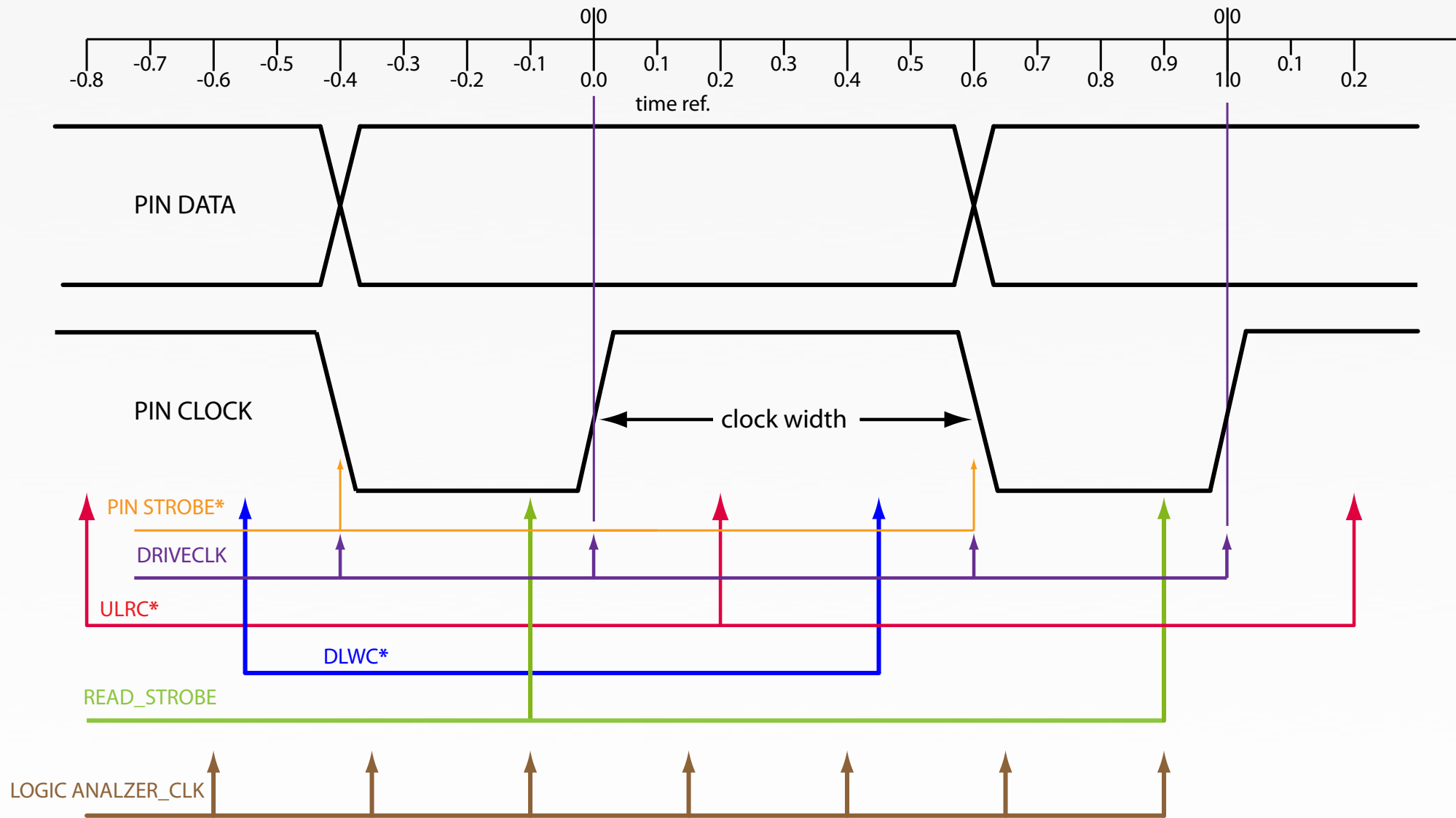


DIAGRAM 1 SCAN CLOCK TIMING REFERENCE



Tap for Zoom View

DRIVE CLK	DRV FOR PINS 1-4, 6-9,11-14, 16-19, 5,10,15	0.0, 0.6
READ_STROBE		-0.1
LA_CLK	LOGIC ANALYZER CLK	-0.35, -0.1, 0.15, 0.4
<hr/>		
*ULRC	INTERNAL REFERENCE CLOCK	0.2
*DLWC	INTERNAL REFERENCE CLOCK	0.45
*PIN STROBE	INTERNAL REFERENCE CLOCK	0.6

## PERFORMANCE SPECIFICATIONS

### Digital

Clock Rate	1 kHz to 100 MHz $\pm 0.1$ Hz
Rise/Fall Times	2 ns
Drive/Compare	0 V to +30 mV (50 $\Omega$ ) $\pm 0.25$ % 0.03 V to +4.0 V (50 $\Omega$ ), $\pm 1$ mV

### Memory

Depth	128 Mb / 16 Mb (optional / standard)
Fail Memory	32k Vectors

### Parametric

$V_{\text{Force   Measure}}$	Continuity Mode: -1.5 V to +3.0 V $\pm 0.25\%$ Leakage Mode: -1.0 V to +4.0 V $\pm 0.25\%$ $\pm 3.0$ to +5 V $\pm 0.1\%$
$I_{\text{Force   Measure}}$	$\pm 20$ mA $\pm 0.25\%$ 20 mA to 20 $\mu$ A $\pm 0.4\%$

This is an abbreviated list of instrument capability and is subject to change without notice. For comprehensive and up-to-date instruments specifications consult the TIM Specification document.

# RI8545: 0.1 TO 20 GHz TESTSET



## DESCRIPTION

The RI8545 Test Set is a microwave instrument used for precision power, phase, and vector RF measurements across 0.1 to 20 GHz. The multichannel architecture interfaces with a Cassini microwave source and receiver instrument to create a 4-port, vector analyzer with enhanced dynamic range and pin resource switching capability. The instrument enables calibrated and error-corrected 2 or 4 port s-parameters, signal power and harmonic measurement, noise figure, and distortion test.

## KEY FEATURES

- 4 Vector Microwave Source & Receive Channels
- NIST Calibrated Noise Source & Vector Error Correction
- Measure Noise Figure, P1dB, Abs. Power & Phase Noise
- Bilateral 2 & 4 Port S-Parameters



## INSTRUMENTS PROVIDED BY THIS TIM

The instrument in this TIM appear as **Test Head** in the panel dialog windows.

Model and Name as it appears in the Tester Configuration:

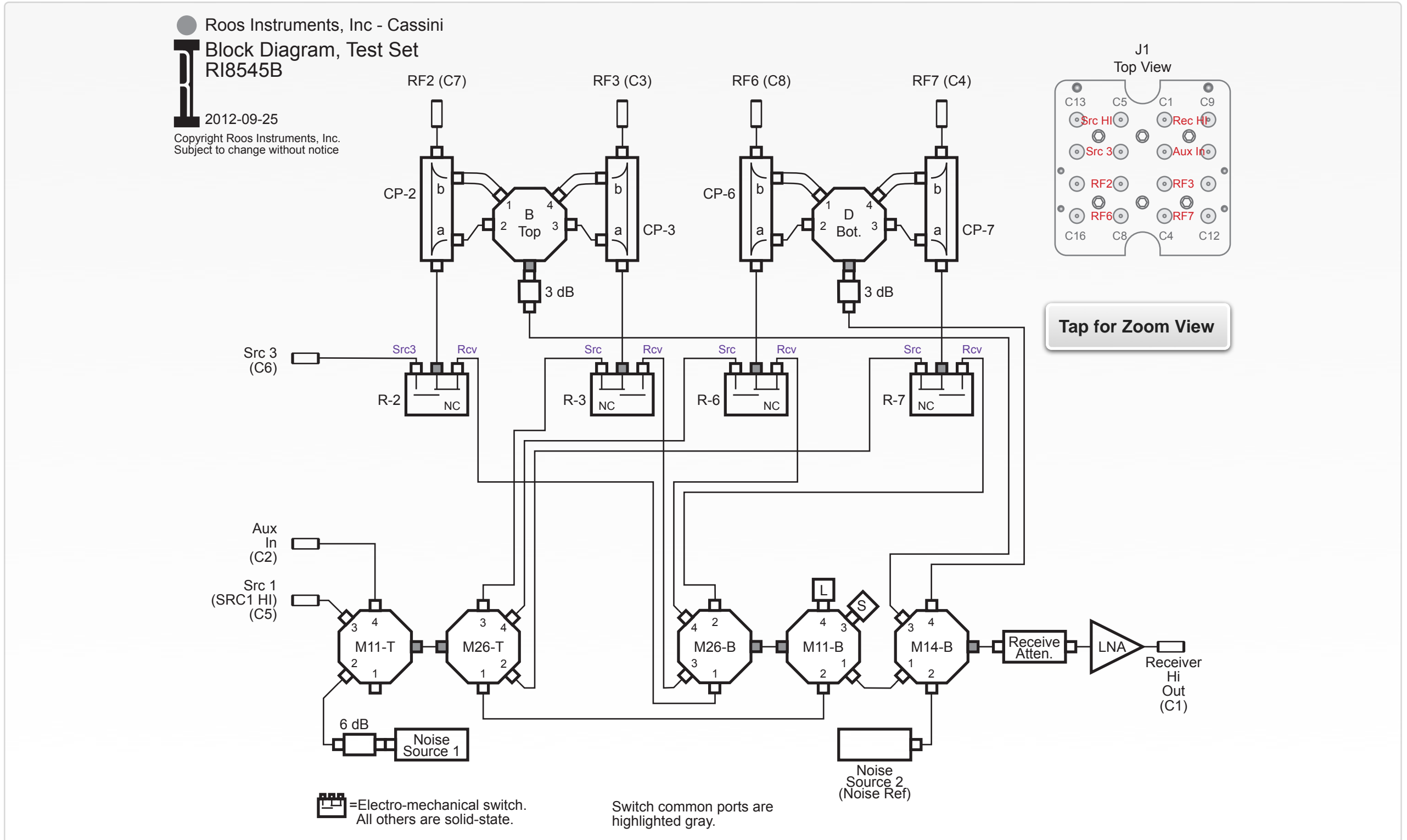
- Test Head, RI8545x 4 port Testset

*NOTE: Multiple RI8545 instruments are enumerated incrementally by the system as “2”, “3”, etc. in the configuration, edit, and control panels (i.e - Test Head, Test Head2, Test Head3, etc). The “x” in RI8564x denotes the model revision number.*

## TIM OPERATIONS

Reference the [RI8545 section](#) of the Graphical Programming chapter for configuration, edit and control panels.

BLOCK DIAGRAM 8.5



## PERFORMANCE SPECIFICATIONS

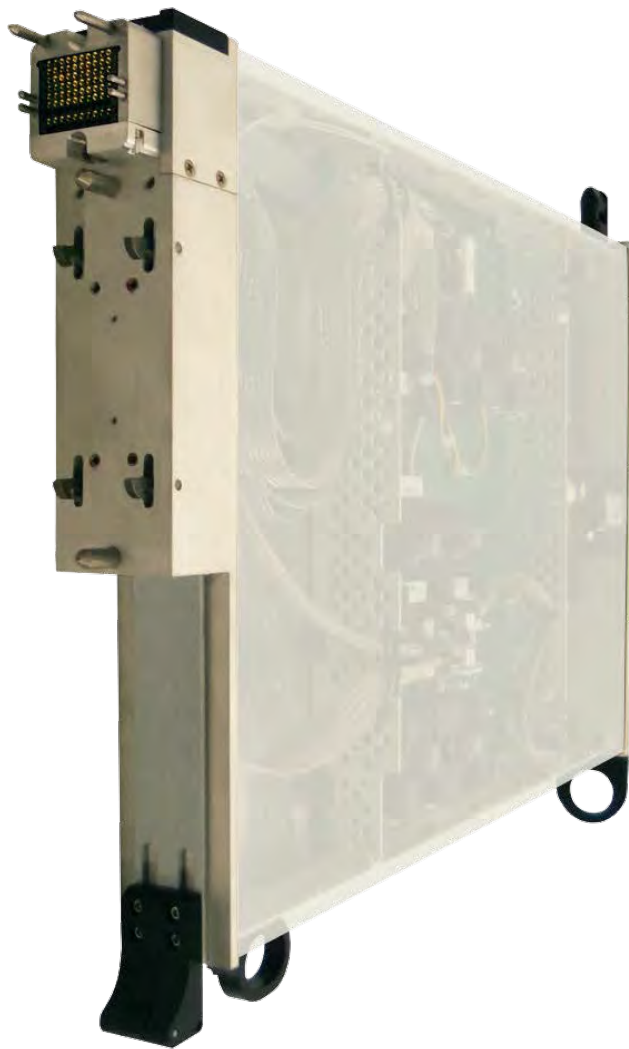
Frequency Range	0.1 GHz to 20 GHz
Signal Power Range <sup>1</sup>	-120dBm to +30dBm
Noise Source ENR	+18dB @ 2 GHz
Power Accuracy	± 0.1dB

---

This is an abbreviated list of instrument capability and is subject to change without notice. For comprehensive and up-to-date instruments specifications consult the TIM Specification document.

<sup>1</sup> Typical performance with an RI8587 Receiver

# RI8546: DEVICE POWER/ MEASURE



## DESCRIPTION

The RI8546 Device Power Instrument provides precision voltage and current supply, digital pin control, and parametric DC measurement in a single instrument. Two high-current power supplies, eight mid-range power supplies, and four low current power supplies provide fast settling voltage and sense feedback for optimal performance in test applications. Eight voltage measure inputs can be configured for differential device applications or ground-referenced multimeter measurements. The internal digital subsystem supports native SPI and I2C protocols along with static pin voltage, continuity and current monitoring.

## KEY FEATURES

- 2 x 3A High Power Supplies, 8 x 200 mA Supplies, 16 Static Digital with Parametric Measure
- Protocol-Aware Digital Pin Programming
- 8 Precision Voltage Measure Inputs

## INSTRUMENTS PROVIDED BY THIS TIM

The instrument in this TIM appear as **DutControl**, **PowerVI**, and **StaticDigital** instruments in the panel dialog windows.

Model and Name as it appears in the Tester Configuration:

- DutControl, RI7421x Dut Control
- PowerVI, RI7431x High Current Supplies
- StaticDigital, RI74311x 16-bit Device Digital Controller

*NOTE: Multiple RI8546 instruments are enumerated incrementally by the system as “2”, “3”, etc. in the configuration, edit, and control panels (i.e - DutControl, PowerVI, StaticDigital ; DutControl2, PowerVI2, StaticDigital2; DutControl3, PowerVI3, StaticDigital3 ; etc.).*

*The “x” in the instrument names denotes the model revision number.*

The DUTControl instrument provides essentially three independent voltage supply and measure resources behind various switching schemes to provide a flexible resource routing network within the TIM:

- 16 device power pins (DP1..DP16) capable of sourcing and measuring DC voltage and current. These pins are subdivided into two banks of eight, with each bank being driven by two independent DC supplies: DP9..DP16 by  $VCC1 \pm 10 V, 200 mA$  and  $VCC2 \pm 10 V, 200 mA$ ; DP1..DP8 by  $VCC3 \pm 10 V, 200 mA$ ;  $VCC4 \pm 10 V, 200 mA$ ). Each pin in the bank of eight can use one of the two supplies with different voltage values, or both can be

used in parallel with the same voltage value for increased current capacity. Each of the four independent supplies has an internal current or voltage measurement resource (*Meas I/V 1/2/3/4*), allowing for current or voltage measurement. An additional *Monitor* line on the device power pins allows a precision measurement resource (*DPVP Meas I/V*) to be switched in to the pin resource to measure voltage, current, or perform continuity type measurements (force current, measure voltage; force voltage, measure current)

- 4 dedicated DC supplies ( $VCC5 \pm 10 V, 200 mA$ ;  $VCC6 \pm 10 V, 200 mA$ ;  $VCC7 \pm 10 V, 200 mA$ ;  $VCC8 \pm 10 V, 200 mA$ ) that drive supply pins  $VCC5F, VCC6F, VCC7F, VCC8F$  with an external sense line pin for each:  $VCC5S, VCC6S, VCC7S, VCC8S$ . These four independent force and sense pin resources can provide additional, high-precision DC voltage at a DUT pin using voltage-sense feedback to compensate for any ohmic losses through the device interface.
- 8 voltage measure pins provide single-ended (ground-referenced) or differential voltage measurement. A switching network between the measure pins and *Meas V  $\pm 10 V$*  resource allows for flexible resource routing.

The PowerVI instrument provides two independent, high-current voltage supply and measure resources:

- Voltage or Current supply from  $VI1 0-10 V, 3 A$  and  $VI2 0-10 V, 3 A$  are available on the TIM’s output pins via  $VI1F(H-3), VI1F(H-5), VI2F(H-8),$  and  $VI2F(H-10)$ . Sense pin resources  $VI1S (H-4)$  and

*VI1S (H-9)* compensate for any ohmic losses through the device interface.

The StaticDigital instrument provides a basic digital communication subsystem and digital pin resources for low-level DUT control, communication, and measurement:


- 16 device bit pins (DB1..DB16) provide static-voltage supply, measure, and can be configured as data, clock, and strobe lines for I2C and serial communications. These pins are subdivided into two banks of eight, with each bank being driven by two independent DC supplies ( $V_{ON} \pm 10\text{ V}, 2\text{ mA}$ ;  $V_{OFF} \pm 10\text{ V}, 2\text{ mA}$ ) to define the 'on' and 'off' voltage states for each bank of 8 pins (high and low bits). A *Monitor* line on the device bits allows a precision measurement resource (*DPVP Meas I/V*) to be switched in to the pin resource to measure voltage, current, or perform continuity type measurements (force current, measure voltage; force voltage, measure current).
- The subset of DB pins listed support higher speed communication up to 1 MHz clock speeds on their respective supply banks: DB1 and DB9 - High-speed Read Pins; DB2 and DB10 - High-speed Write Pins; DB3 and DB11 - High-speed Clock Pins

## TIM OPERATIONS

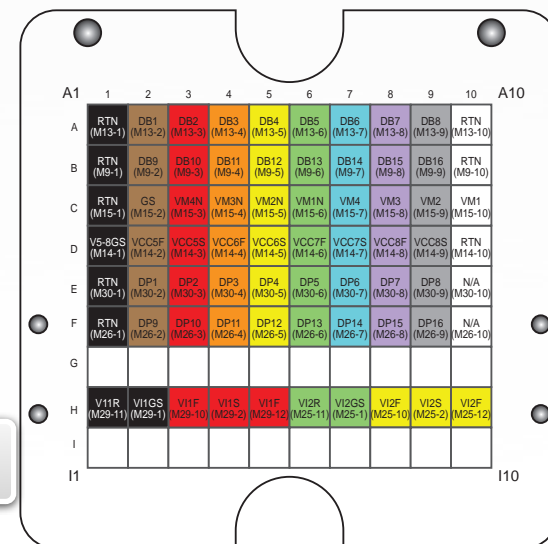
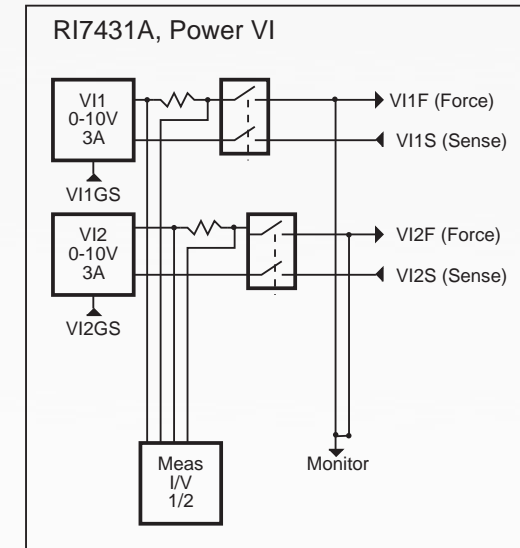
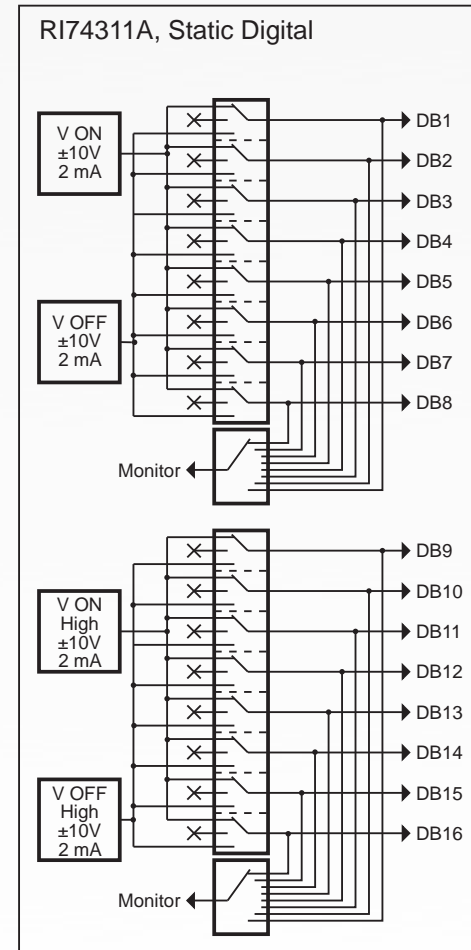
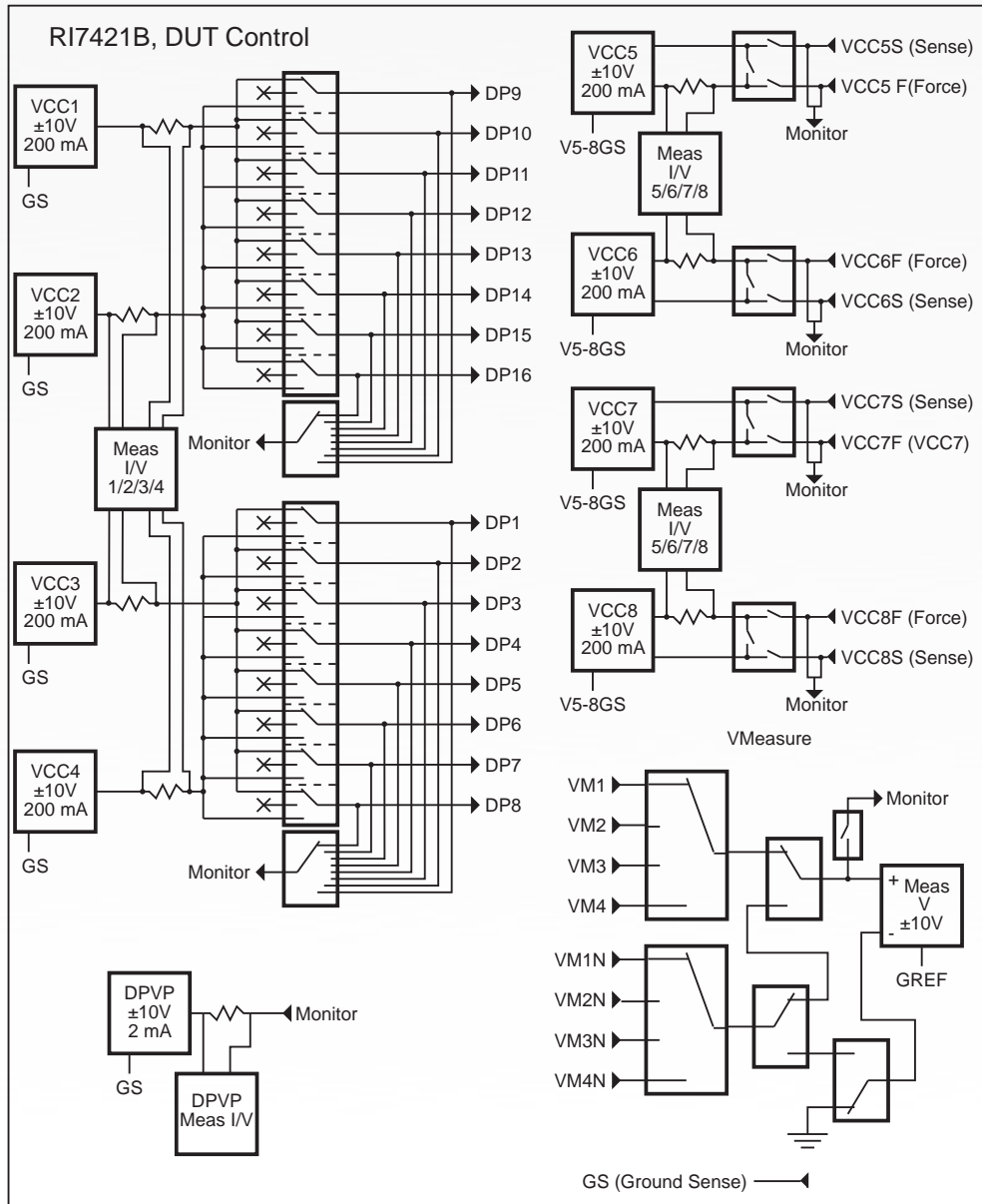
Reference the [RI8546 section](#) of the Graphical Programming chapter for configuration, edit and control panels.



## BLOCK DIAGRAM 8.6


**Roos Instruments, Inc - Cassini**  
**Device Power**  
**RI8546A/B/C**  
 2012-08-24  
 Copyright Roos Instruments, Inc.  
 Subject to change without notice

**Notes:**  
 1) GS, VCC5-8GS and VI\*GS are the ground references. They should be grounded at the DUT.  
 2) VI RTN are the high current return for VIs. They should be grounded at the DUT with heavy wire.  
 3) Values are for reference only.  
 Refer to specifications for complete performance values.



Tap for Zoom View

## PERFORMANCE SPECIFICATIONS

	Supply <sup>1</sup>		Measure <sup>1</sup>	
	Range	Precision	Range	Resolution
Device Power	±10 V ±200 mA	0.3 mV 10 µA	±10 V 0.250 mA to 250 mA	0.3 mV 36 nA
High Power	0 V to 10 V 2.5 A (max) 3 A (pulsed)	10 mV	0 V to 10 V 30 mA to 3 A	10 mV 44 µA
V Measure	±10 V ±2 mA	5 mV 1 µA	±10 V ±2 µA to ±2 mA <sup>1</sup>	1.5 mV 12 pA to 290 µA <sup>1</sup>
Static Digital	±10 V ±2 mA (max)	± 0.1dB	Protocol	
			SPI	60 kbits / 2.5 Mbits
			I <sup>2</sup> C	60 kbits / 2.5 Mbits

This is an abbreviated list of instrument capability and is subject to change without notice. For comprehensive and up-to-date instruments specifications consult the TIM Specification document.

<sup>1</sup> Range/Resolution limits set by instrument mode.

# RI8556: SMALL CASSINI INFRASTRUCTURE



## DESCRIPTION

The RI8556A model infrastructure is commonly referred to as the Small Cassini or Cassini 8. It includes a test head with 8 slots and manipulator arm with 4 degrees of freedom: vertical lift, rotation, horizontal extension, and pivotal movement. The integrated instrument rack houses AC/DC power supply, the system controller, and supports Cassini 8 instrumentation.

## RI8556A INFRASTRUCTURE DIMENSIONS

- Height: 1590 mm (62.6 in)
- Table Surface Height: 925 mm (36.4 in)
- Depth: 733 mm (28.9 in)
- Width: 853 mm (33.6 in)
- Max Shipping Weight: 250 Kg (550 lbs)

## INSTRUMENTS PROVIDED BY THIS TIM

The instrument in this TIM appears as **Tester** in the panel dialog windows.

Model and Name as it appears in the Tester Configuration:

- Tester, Ri8549x Cassini 8 Slot Tester

## TESTER VOLTAGE SPECIFICATIONS

Tester instrument provides power to the Fixture, Fixture Modules and any active components installed on the DIB.

Voltage (V)	Max Current (A)
+5	1.51
+15	0.5
+28	0.5
-15	0.5
-5	1.5

## INSTRUMENT LOCATION

The FIX block is located in the center of the Test Head . A Harness Block or Pin Block is used to access resources provided by the Tester instrument.

## INSTRUMENT OPERATIONS

Reference the **Tester** instrument in the [RI8574 System Controller section](#) of the Graphical Programming chapter for configuration, edit and control panels.

FIGURE 8.1 RI8556A INFRASTRUCTURE DIMENSIONS

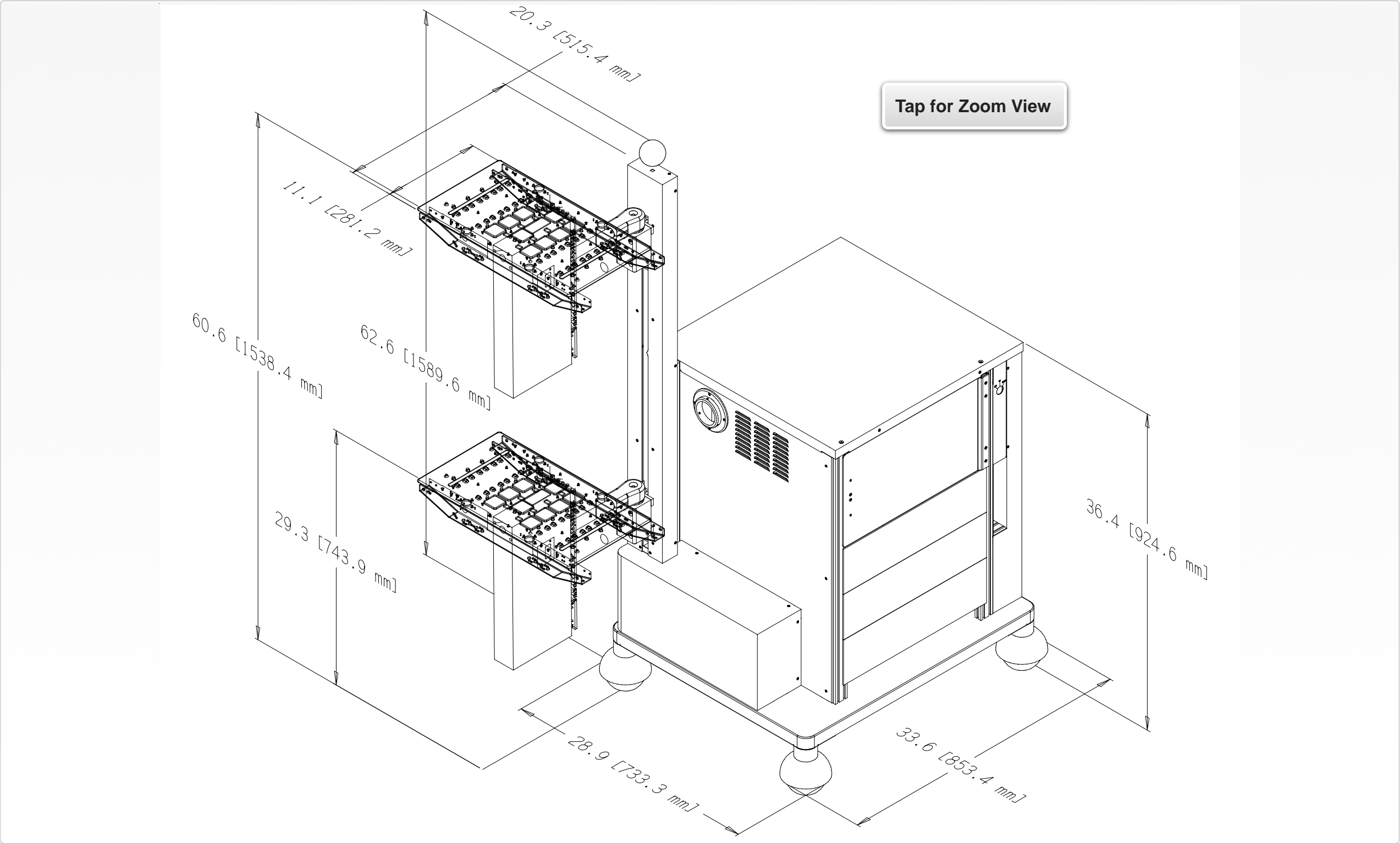


FIGURE 8.2 RI8556A TEST HEAD TRAVEL

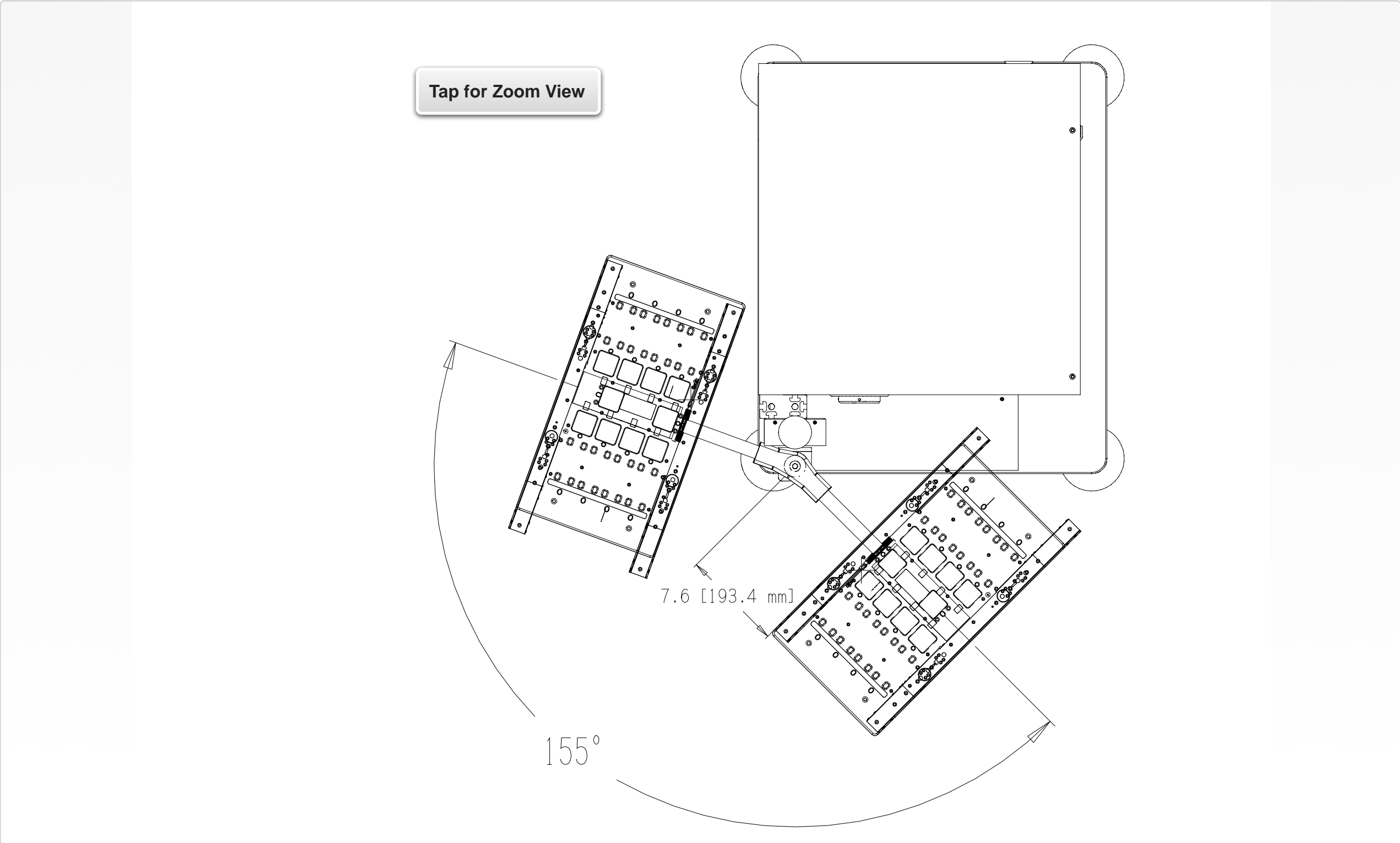
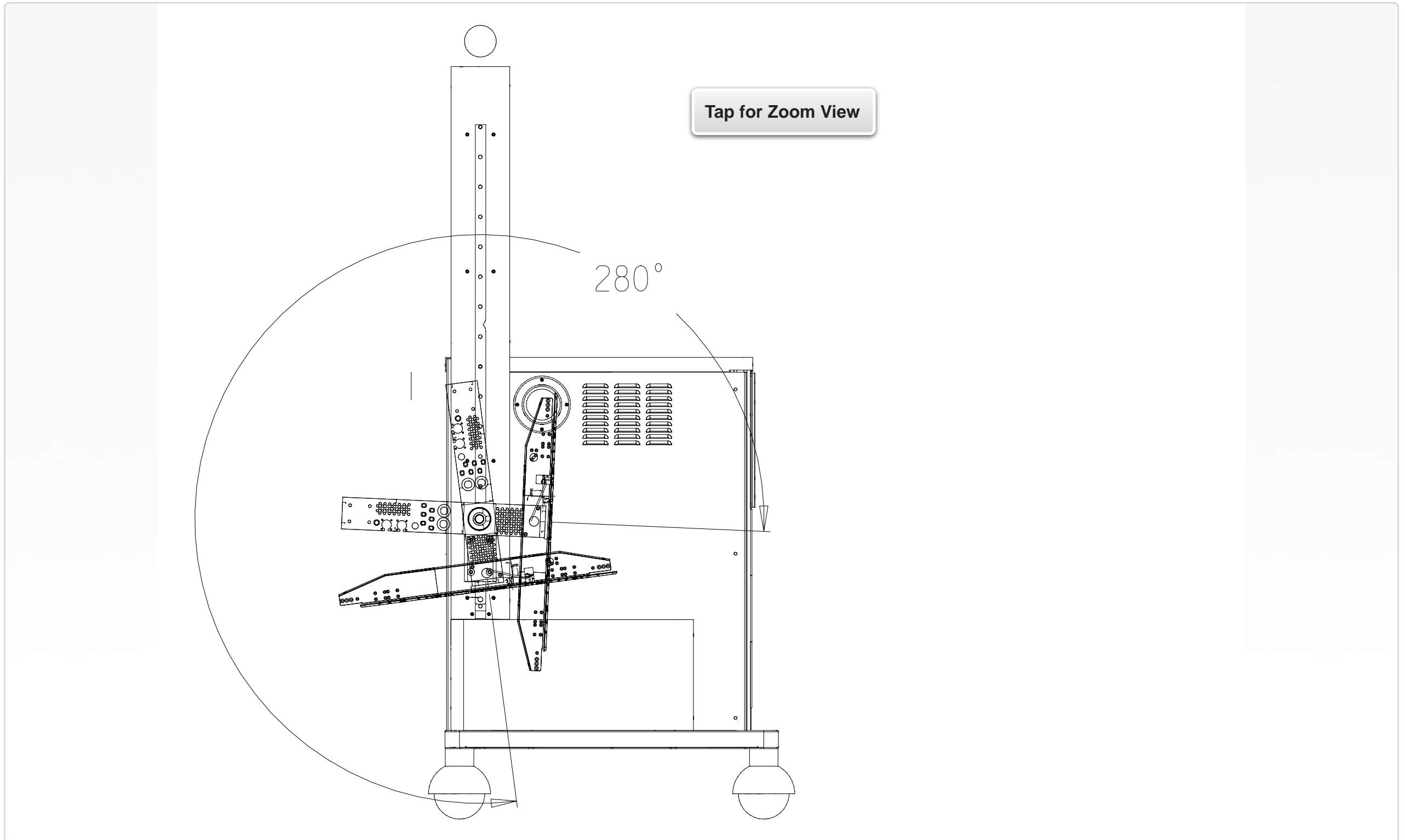




FIGURE 8.3 RI8556A TEST HEAD ROTATION



# RI8557: LARGE CASSINI INFRASTRUCTURE



## DESCRIPTION

The RI8557A model infrastructure is commonly referred to as the Large Cassini, Big Cassini, Tall Cassini or RI7100C. It includes a test head with 8 slots and manipulator arm with 4 degrees of freedom: vertical lift, rotation, horizontal extension, and pivotal movement. The auxiliary rack houses AC/DC power supply, the system controller, and Test Head holds 8 Cassini TIMs.

## RI8557A INFRASTRUCTURE DIMENSIONS

- Height: 1698 mm (66.9 in)
- Depth: 900 mm (35.4 in)
- Width: 838 mm (33.0 in)
- Max Shipping Weight: 300 Kg (660 lbs)

## INSTRUMENTS PROVIDED BY THIS TIM

The instrument in this TIM appears as **Tester** in the panel dialog windows.

Model and Name as it appears in the Tester Configuration:

- Tester, Ri8549x Cassini 8 Slot Tester

## TESTER VOLTAGE SPECIFICATIONS

Tester instrument provides power to the Fixture, Fixture Modules and any active components installed on the DIB.

Voltage (V)	Max Current (A)
+5	1.51
+15	0.5
+28	0.5
-15	0.5
-5	1.5

## INSTRUMENT LOCATION

The FIX block is located in the center of the Test Head . A Harness Block or Pin Block is used to access resources provided by the Tester instrument.

## INSTRUMENT OPERATIONS

Reference the **Tester** instrument in the [RI8574 System Controller section](#) of the Graphical Programming chapter for configuration, edit and control panels.

FIGURE 8.4 RI8557A INFRASTRUCTURE FOOTPRINT

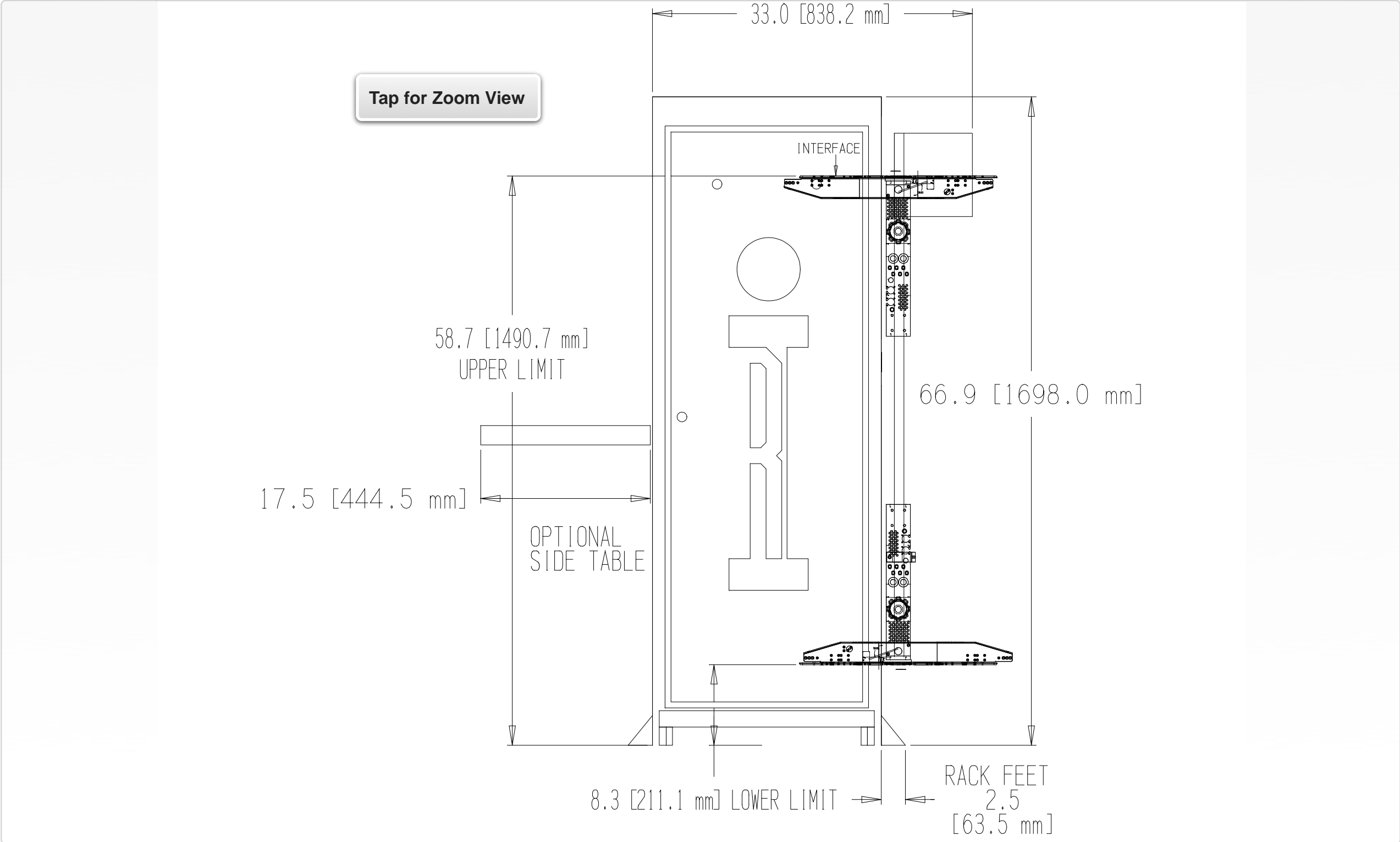


FIGURE 8.5 RI8557A TEST HEAD ROTATION COMPLIANCE

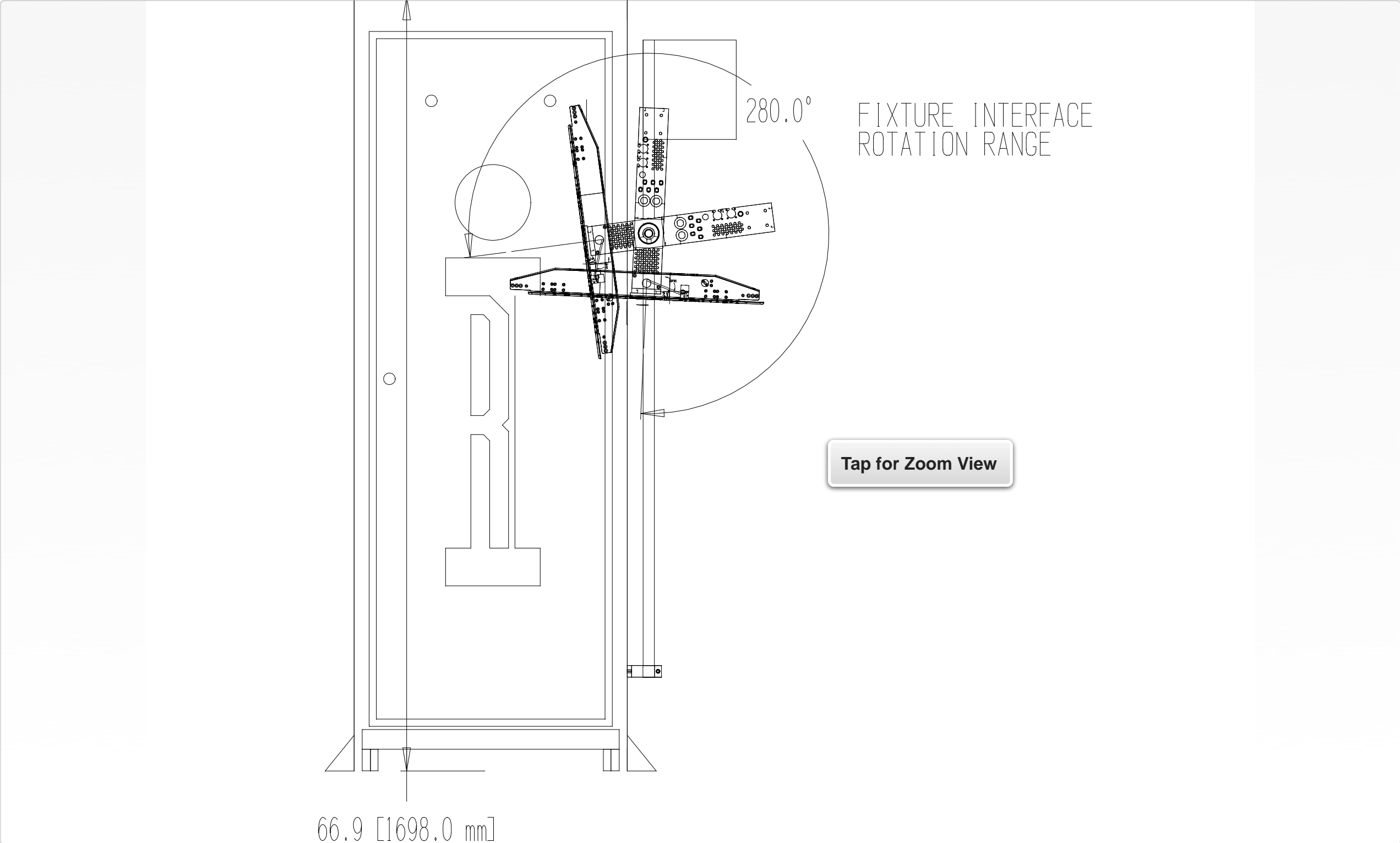


FIGURE 8.6 RI8557A TEST HEAD PIVOTAL COMPLIANCE

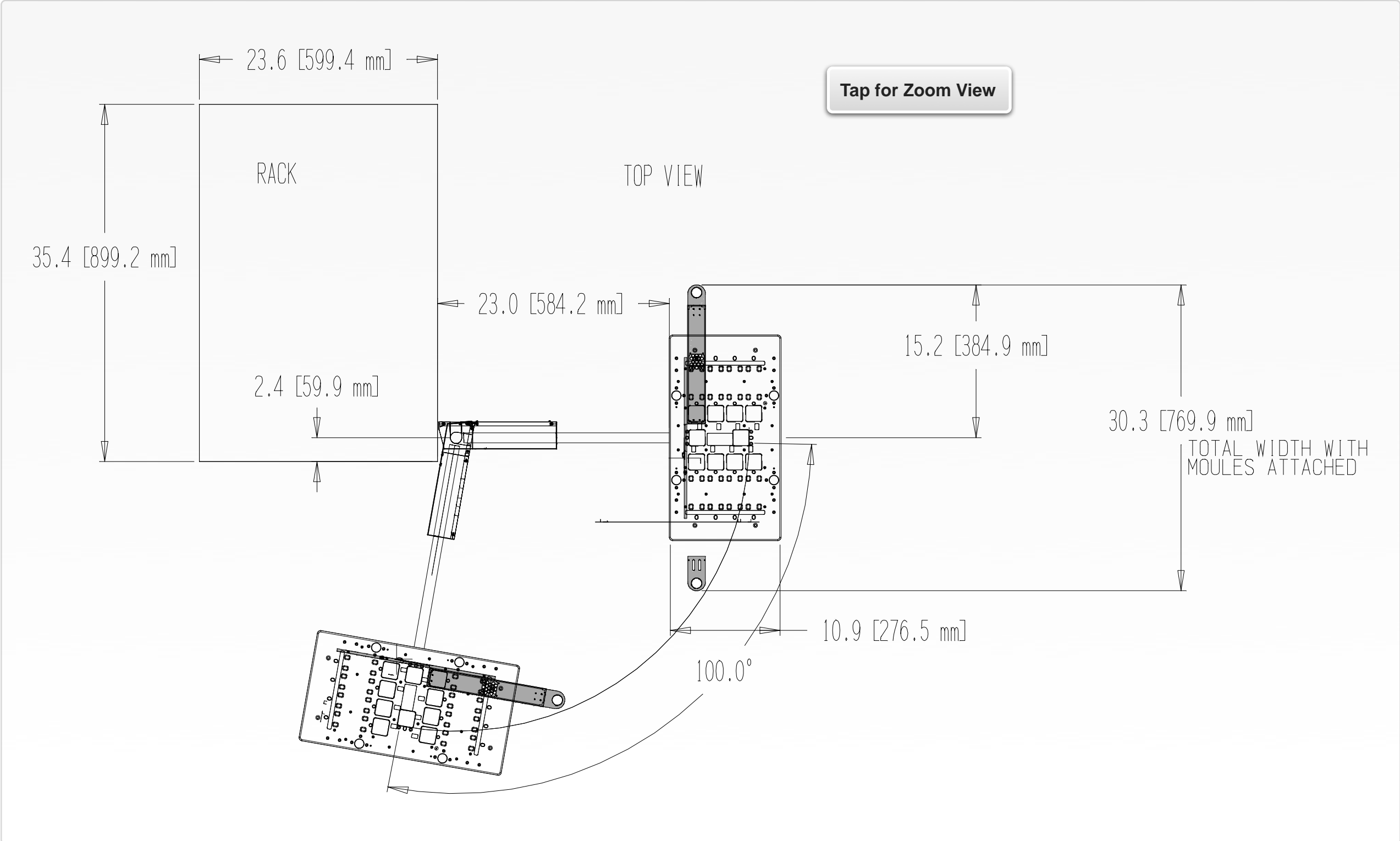
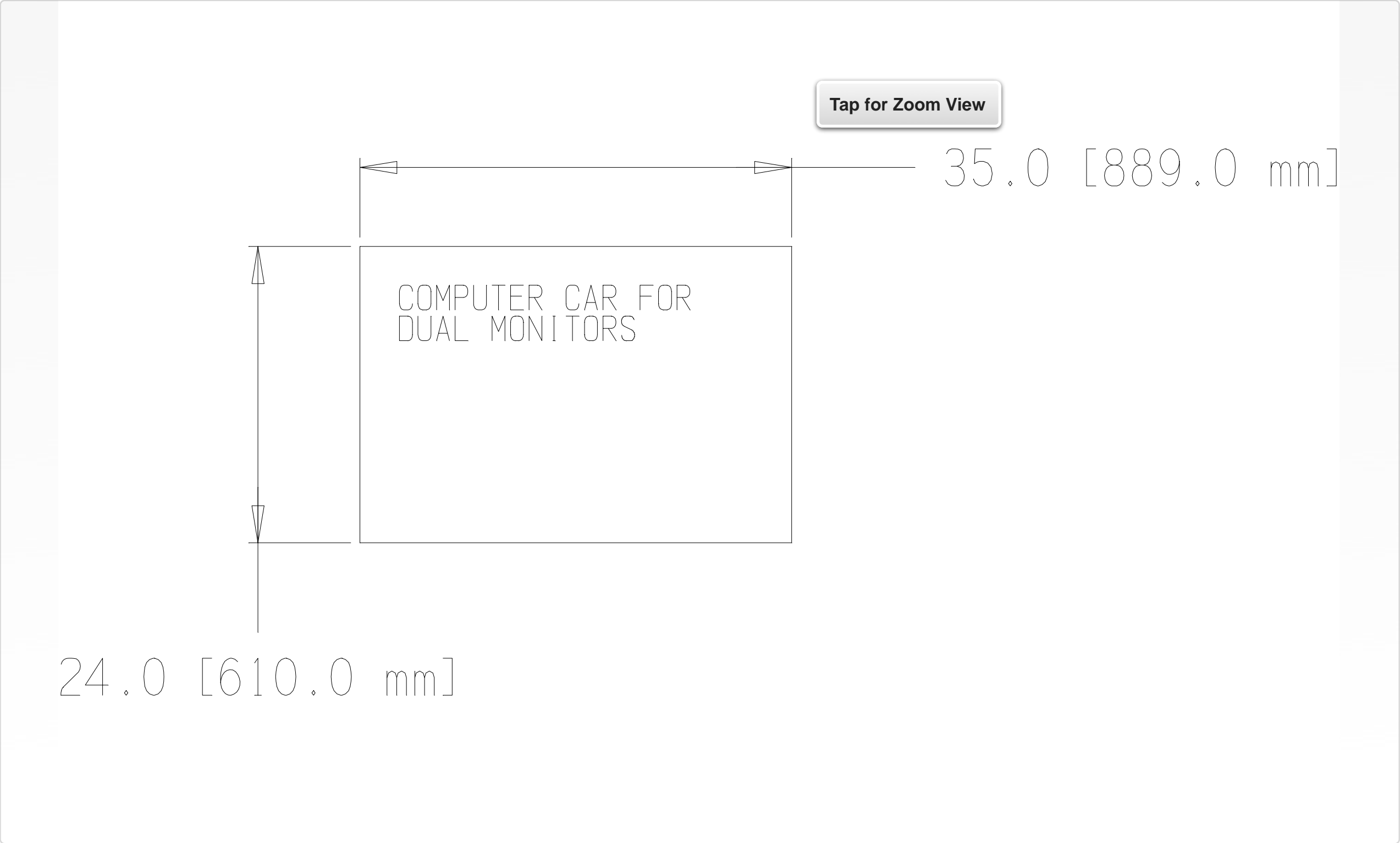
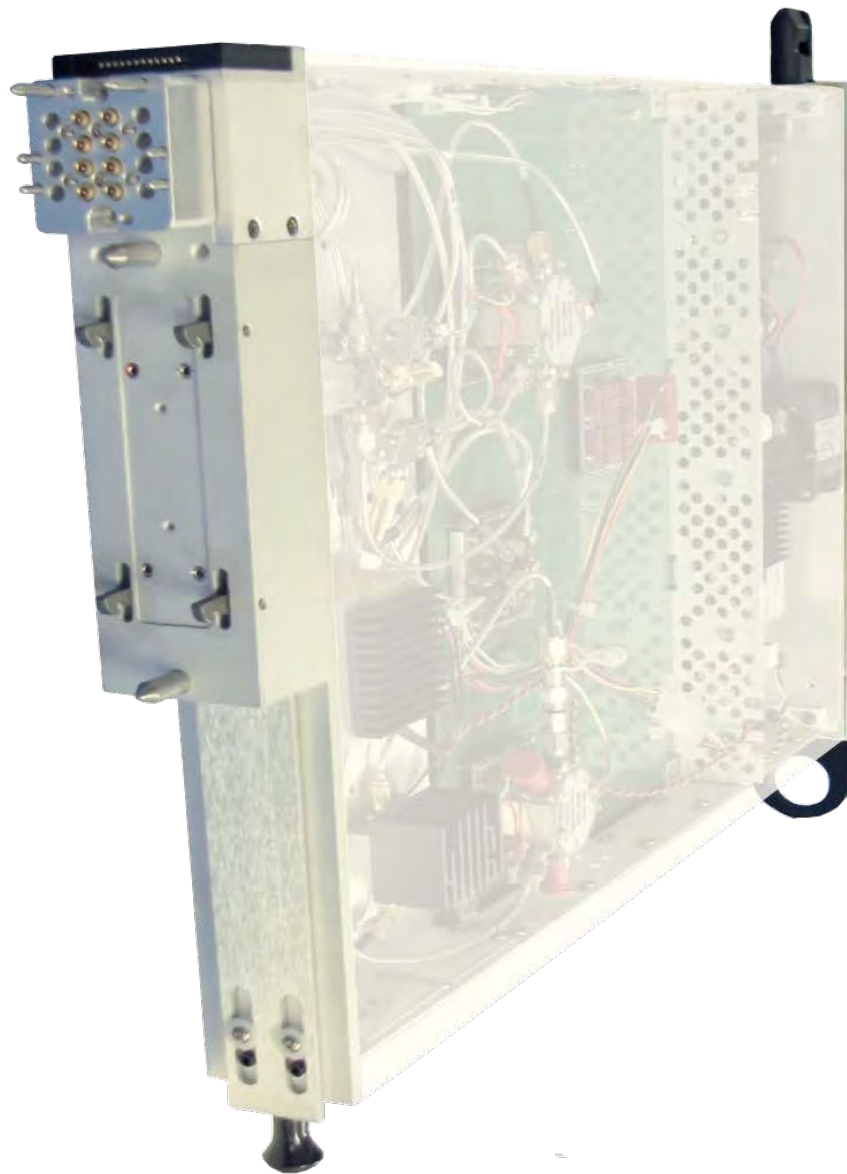




FIGURE 8.7 RI8557A OPTIONAL COMPUTER CART DIMENSIONS



# RI8563: 4GHz TO 40.5GHz TESTSET



## DESCRIPTION

The RI8563 Test Set extends the frequency and application capability of Cassini's 2-port vector measurements to the 4 GHz - 40.5 GHz range. Calibrated RF paths deliver precision source and measure of signal power, distortion test, s-parameters, and harmonic measurement. Designed to interface with a Cassini receiver and source instrument, the RI8563 can be shared across multiple microwave I/O for fast, precision measurements and maximum channel utilization.

## KEY FEATURES

- S-Parameters from 4 GHz to 40.5 GHz
- NIST Calibrated Noise Source & Vector Error Correction
- Measure Noise Figure, P1dB, Abs. Power & Phase Noise
- Bilateral 2 & 4 Port S-Parameters

## INSTRUMENTS PROVIDED BY THIS TIM

The instrument in this TIM appear as **Test Head40** in the panel dialog windows.

Model and Name as it appears in the Tester Configuration:


- Test Head40, RI8563x 4-40.5 GHz Test Set

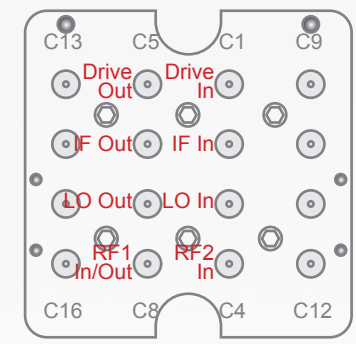
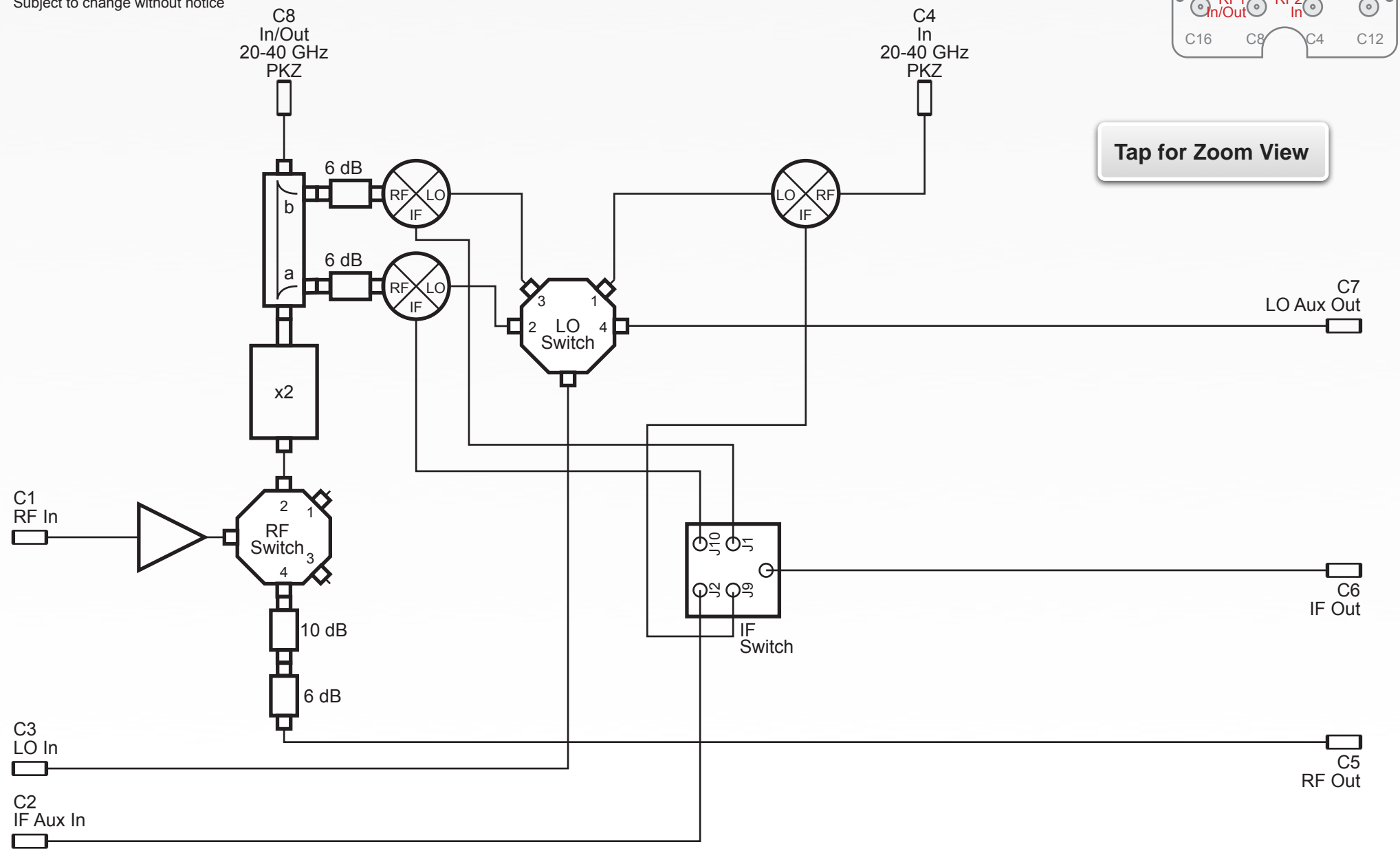
*NOTE: Multiple RI8563 instruments are enumerated incrementally by the system as “2”, “3”, etc. in the configuration, edit, and control panels (i.e - Test Head40, Test Head402, Test Head403, etc). The “x” in RI8563x denotes the model revision number.*

## TIM OPERATIONS

Reference the [RI8563 section](#) of the Graphical Programming chapter for configuration, edit and control panels.

BLOCK DIAGRAM 8.7


**Roos Instruments, Inc - Cassini**  
**Block Diagram, RI8563C**  
**40.5 GHz, 2-Port-1-Path TIM**  
 2011-08-15  
 Copyright Roos Instruments, Inc.  
 Subject to change without notice



Tap for Zoom View

## PERFORMANCE SPECIFICATIONS

### Source

---

Frequency Range	4 GHz to 40.5 GHz
Frequency Resolution	2 Hz
Power Range <sup>2</sup>	-25 dBm to +3 dBm
Power Accuracy	± 0.1 dB

### Measure

---

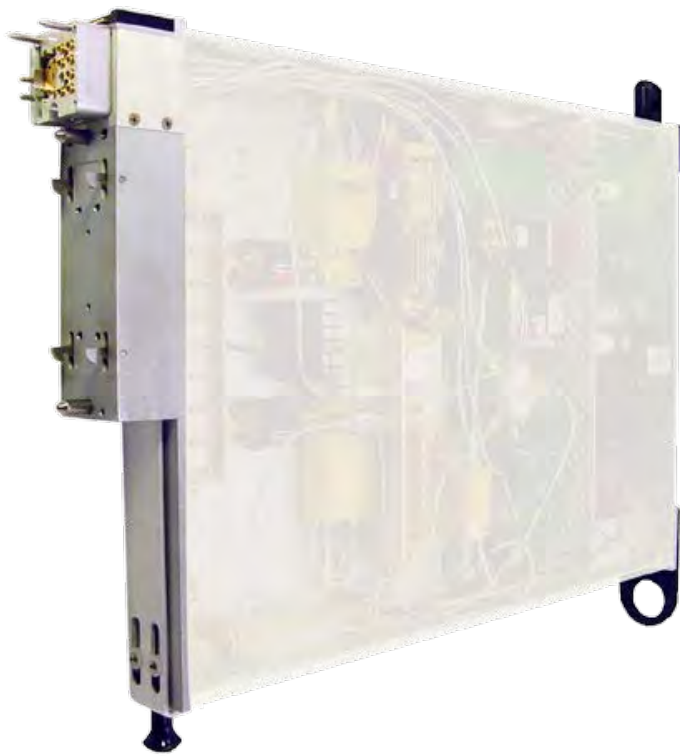
Frequency Range	4 GHz to 40.5 GHz
Power Range	-115 dBm to +20 dBm

---

This is an abbreviated list of instrument capability and is subject to change without notice. For comprehensive and up-to-date instruments specifications consult the TIM Specification document.

<sup>2</sup> Typical performance with an RI8587 Receiver

# RI8564: 71GHz TO 86GHz TESTSET



## DESCRIPTION

The RI8564 mmWave test port TIM extends the frequency and application capability of Cassini's vector measurements to the 71 GHz to 86 GHz range. Calibrated RF paths deliver precision source and measure of signal power, distortion test, s-parameters, and harmonic measurement. Designed to interface with a Cassini receiver and source instrument, the RI8564 can be shared across multiple microwave I/O for fast, precision measurements and maximum channel utilization.

## KEY FEATURES

- S-Parameters from 71 GHz to 86 GHz
- NIST Calibrated Noise Source & Vector Error Correction
- Measure Noise Figure, P1dB, Abs. Power & Phase Noise
- Waveguide S-Parameter Port

---

**RI8564B frequency range is 75GHz to 81GHz.**

**RI8564C frequency range is 71GHz to 86GHz.**

---



## INSTRUMENTS PROVIDED BY THIS TIM

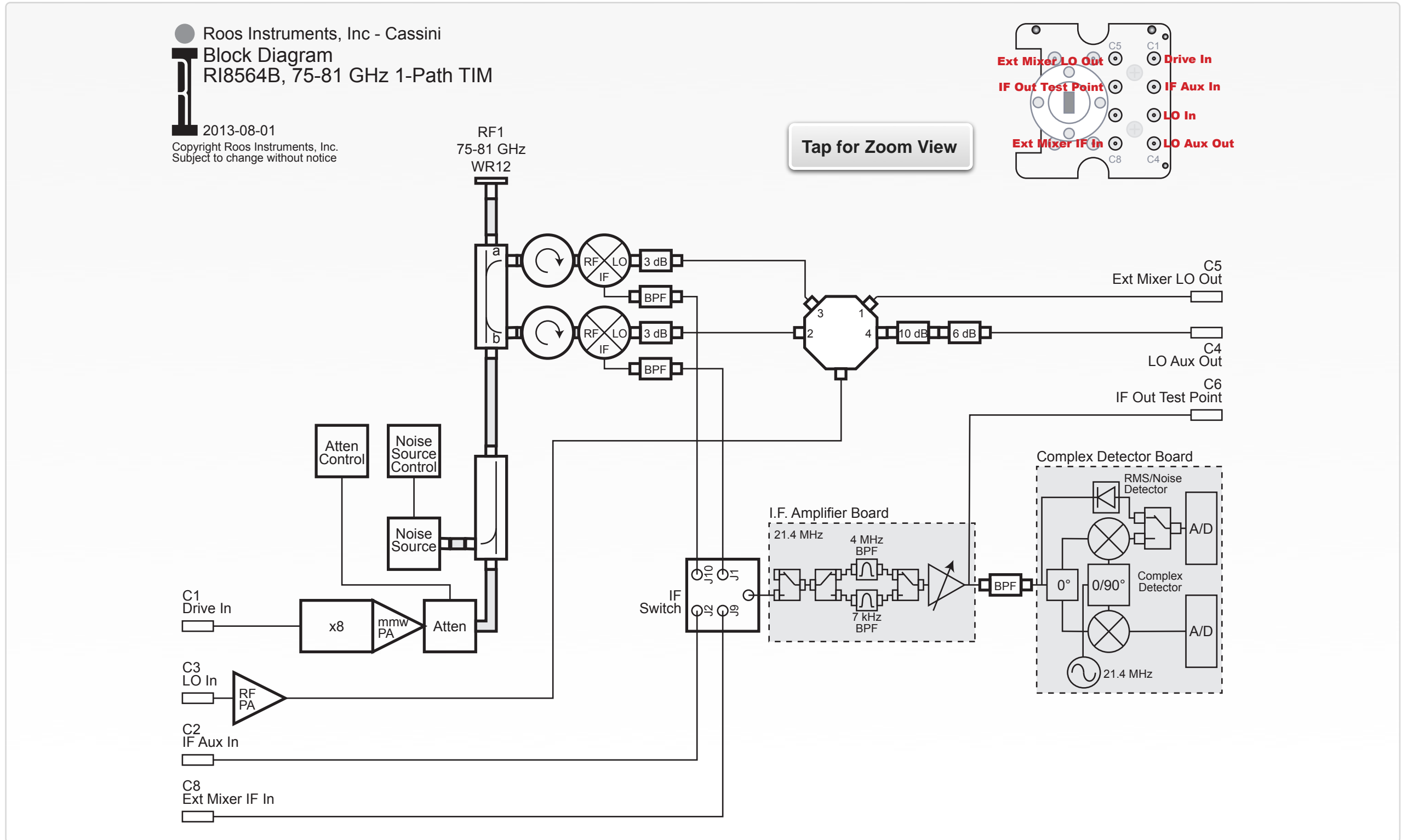
The instrument in this TIM appear as **Test Head77** in the panel dialog windows. (See [Graphical Programming](#) chapter)

Model and Name as it appears in the Tester Configuration:

- Test Head77, RI8564x 81 GHz Test Set

*NOTE: Multiple RI8564 instruments are enumerated incrementally by the system as “2”, “3”, etc. in the configuration, edit, and control panels (i.e - Test Head77, Test Head772, Test Head773, etc). The “x” in RI8564x denotes the model revision number.*

BLOCK DIAGRAM 8.8 (RI8564B VERSION)



## PERFORMANCE SPECIFICATIONS (RI8564B VERSION)

### Source

---

Frequency Range	75 GHz to 81 GHz
Frequency Resolution	8 Hz
Power Range <sup>1</sup>	-20 dBm to +5 dBm
Power Accuracy	± 0.2 dB

### Measure


---

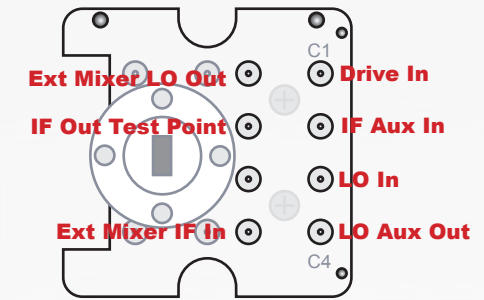
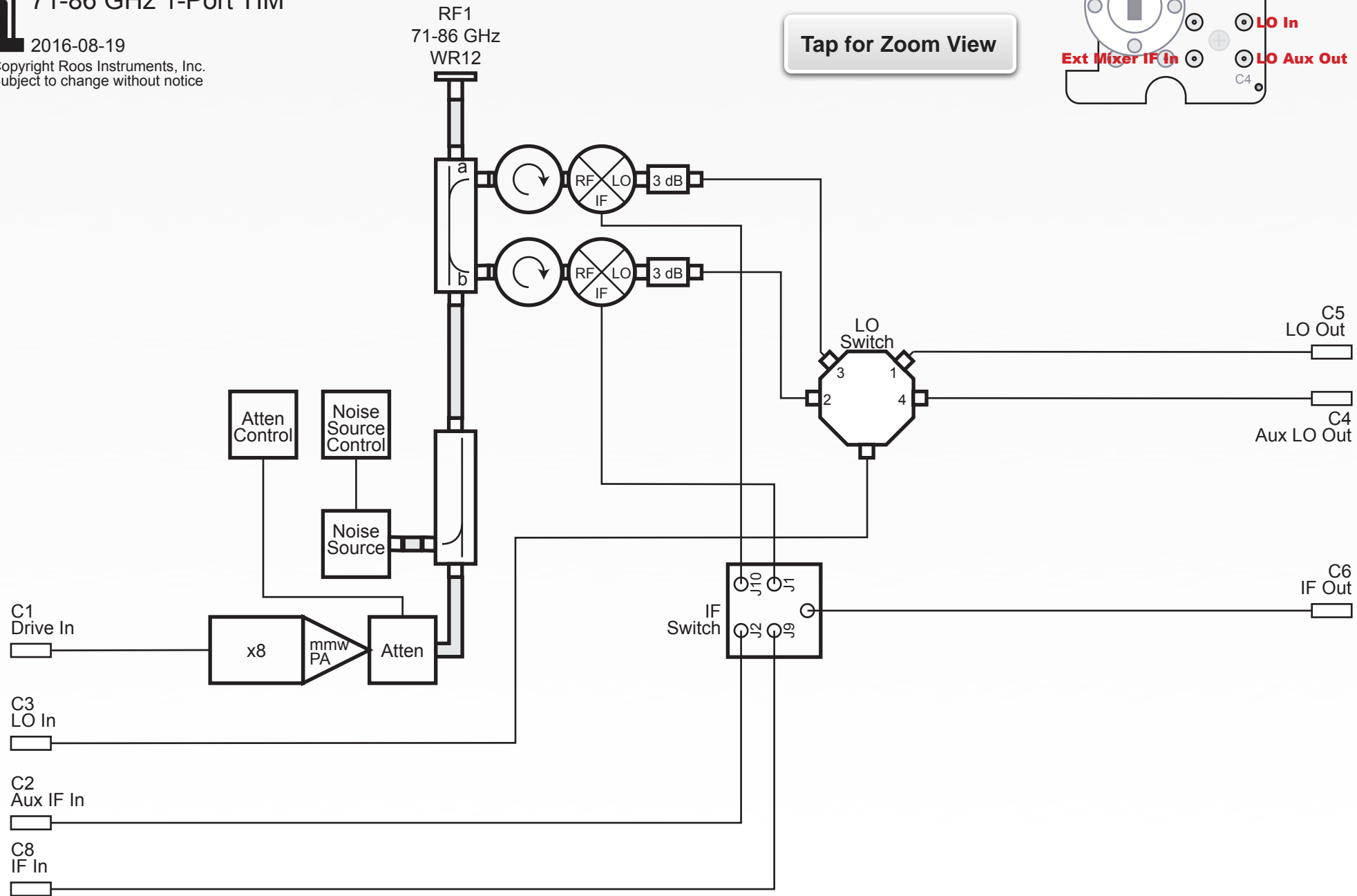
Frequency Range	75 GHz to 81 GHz
Power Range	-110 dBm to +10 dBm

This is an abbreviated list of instrument capability and is subject to change without notice. For comprehensive and up-to-date instruments specifications consult the TIM Specification document.

<sup>1</sup> Typical performance with an RI8587 Receiver.

BLOCK DIAGRAM 8.9 (RI8564C VERSION)


 Roos Instruments, Inc - Cassini  
 Block Diagram  
 RI8564C  
 71-86 GHz 1-Port TIM  
 2016-08-19  
 Copyright Roos Instruments, Inc.  
 Subject to change without notice



## PERFORMANCE SPECIFICATIONS (RI8564C VERSION)

### Source

---

Frequency Range	71 GHz to 86 GHz
Frequency Resolution	8 Hz
Power Range <sup>1</sup>	-45 dBm to +5 dBm

### Measure

---

Frequency Range	71 GHz to 86 GHz
Power Range	-110 dBm to +10 dBm

---

This is an abbreviated list of instrument capability and is subject to change without notice. For comprehensive and up-to-date instruments specifications consult the TIM Specification document.

<sup>1</sup> Typical performance with an RI8587 Receiver.

# RI8567: 0.01 TO 12GHZ TESTSET



## DESCRIPTION

The RI8567 instruments combines a 2-port RF vector Testset and a complex RF Receiver in a single TIM. The front-end includes a versatile, solid-state RF switch network for hot-swappable, adaptive transmit and receive topologies. The built-in receiver uses a synchrodyne back-end that provides precision RF vector measurements and fast settling times. High-linearity mixers and a selectable analog filter bank in the receiver provide the user with up to 7 MHz of instantaneous detection bandwidth and signal measurement sensitivity down to -100 dBm.

## KEY FEATURES

- 2 S-Parameter ports that cover 100 MHz to 12 GHz range
- Base-band vector receiver with SyRF Core DSP capability
- Integrated LO with Microsecond Frequency Locking
- Dual Measurement Engines, True RMS & Vector I & Q
- Production-Speed RF Resource Switching Capability



## INSTRUMENTS PROVIDED BY THIS TIM

The instrument in this TIM appear as **RFMeasure1** in the panel dialog windows.

Model and Name as it appears in the Tester Configuration:

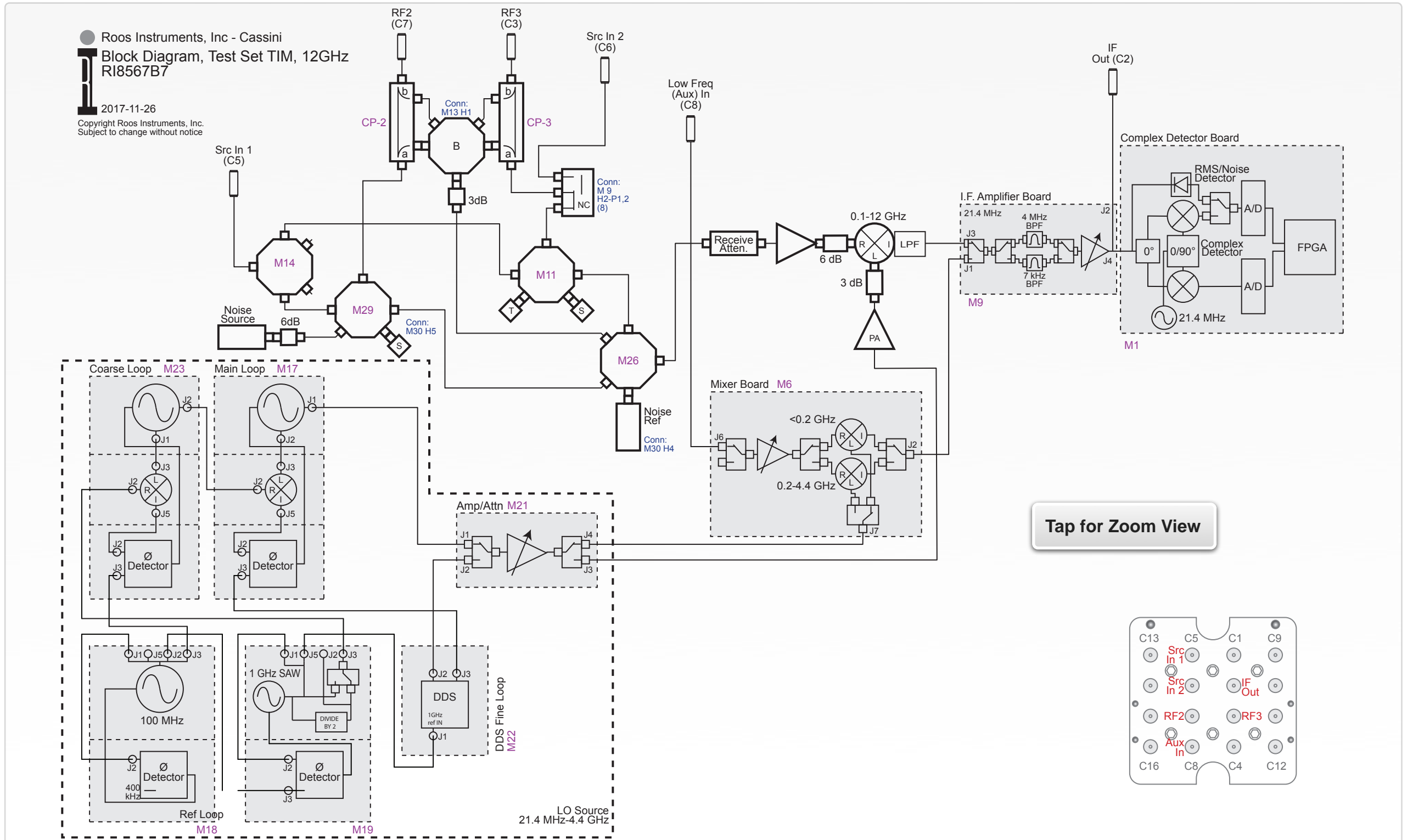
- RfMeasure1, RI8567x 2 port Testset+Receiver

*NOTE: Multiple RI8567 instruments are enumerated incrementally by the system as “2”, “3”, etc. in the configuration, edit, and control panels (i.e - RFMeasure1, RFMeasure2, RFMeasure3, etc). The “x” in RI8567x denotes the model revision number.*

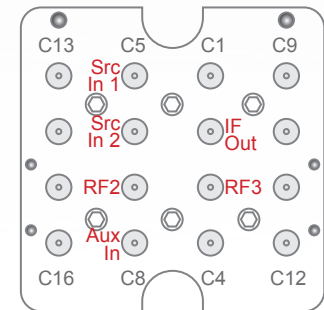
## TIM OPERATIONS

Reference the [RI8567 section](#) of the Graphical Programming chapter for configuration, edit and control panels.

BLOCK DIAGRAM 8.10



Tap for Zoom View



## PERFORMANCE SPECIFICATIONS

### Vector Analyzer

---

Frequency Range	100 MHz to 12 GHz
Frequency Resolution	0.1 Hz
Power Range <sup>2</sup>	-100 dBm to +30 dBm
Power Accuracy	± 0.1 dB

### Receiver Measure

---

Frequency Range	100 kHz to 12 GHz
Power Range	-115 dBm to +20 dBm
Analog Bandwidths	7 kHz, 200 kHz, 5 MHz (user Selectable)

---

This is an abbreviated list of instrument capability and is subject to change without notice. For comprehensive and up-to-date instruments specifications consult the TIM Specification document.

<sup>2</sup> Typical performance with an RI8587 Receiver.

# RI8568: CASSINI 16 INFRASTRUCTURE



## DESCRIPTION

The RI8568B model infrastructure is commonly referred to as Cassini 16. It includes a 16 slot test head with pneumatic device interface docking and manipulator arm with 6 degrees of freedom: vertical lift, test head rotation, 2-axis planar movement, and 2-axis pitch movement. The infrastructure provides a minimal test floor footprint and compliance with multiple handler and prober setups. The chassis includes standard pneumatic hook ups and attachment options auxiliary rack instruments. Desktop or TouchUI Production options can be selected depending on the primary use. **Values are subject to change without notice.**

## RI8556A INFRASTRUCTURE DIMENSIONS

- Height: 1,740 mm (68.5 in)
- Depth: 1,208 mm (47.6 in)
- Width: 844 mm (33.2 in)
- System Weight: 105 Kg (230 lbs)
- Typical/MAX Shipping Weight: 250 Kg (550 lbs)/385 Kg (850 lbs)

## INSTRUMENTS PROVIDED BY THIS TIM

The instrument in this TIM appears as **Tester** in the panel dialog windows.

Model and Name as it appears in the Tester Configuration:

- Tester, Ri8568x Cassini 16 Slot Tester

## TESTER VOLTAGE SPECIFICATIONS

Tester instrument provides power to the Fixture, Fixture Modules and any active components installed on the DIB.

Voltage (V)	Max Current (A)
+5	1.51
+15	0.5
+28	0.5
-15	0.5
-5	1.5

## INSTRUMENT LOCATION

The FIX block is located in the center of the Test Head . A Harness Block or Pin Block is used to access resources provided by the Tester instrument.

## INSTRUMENT OPERATIONS

Reference the **Tester** instrument in the [RI8574 System Controller section](#) of the Graphical Programming chapter for configuration, edit and control panels.

FIGURE 8.8 RI8568B (CASSINI 16) FOOTPRINT

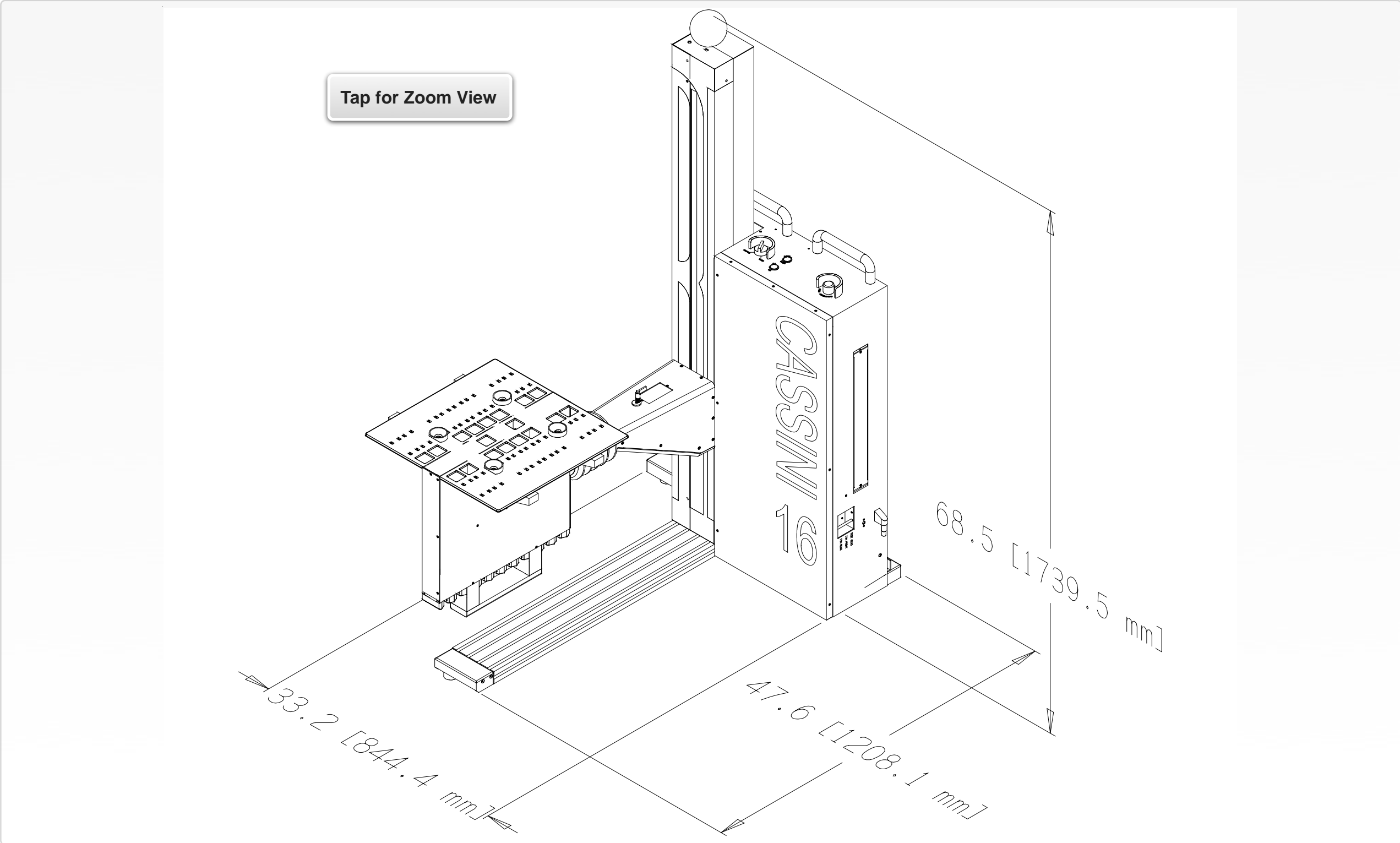




FIGURE 8.9 RI8568B UPPER AND LOWER LIFT LIMIT

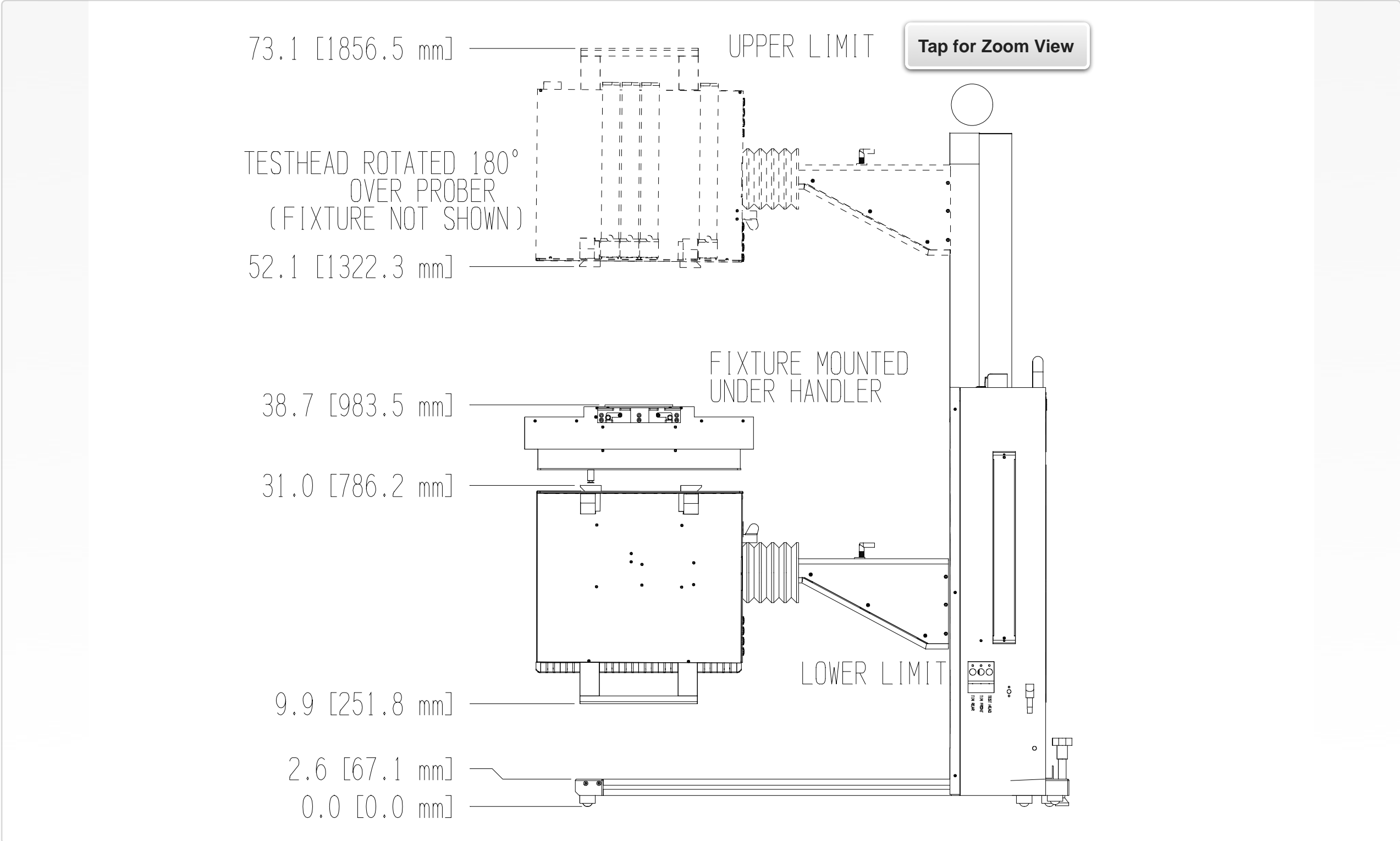


FIGURE 8.10 RI8568B TOTAL HEAD ROTATION

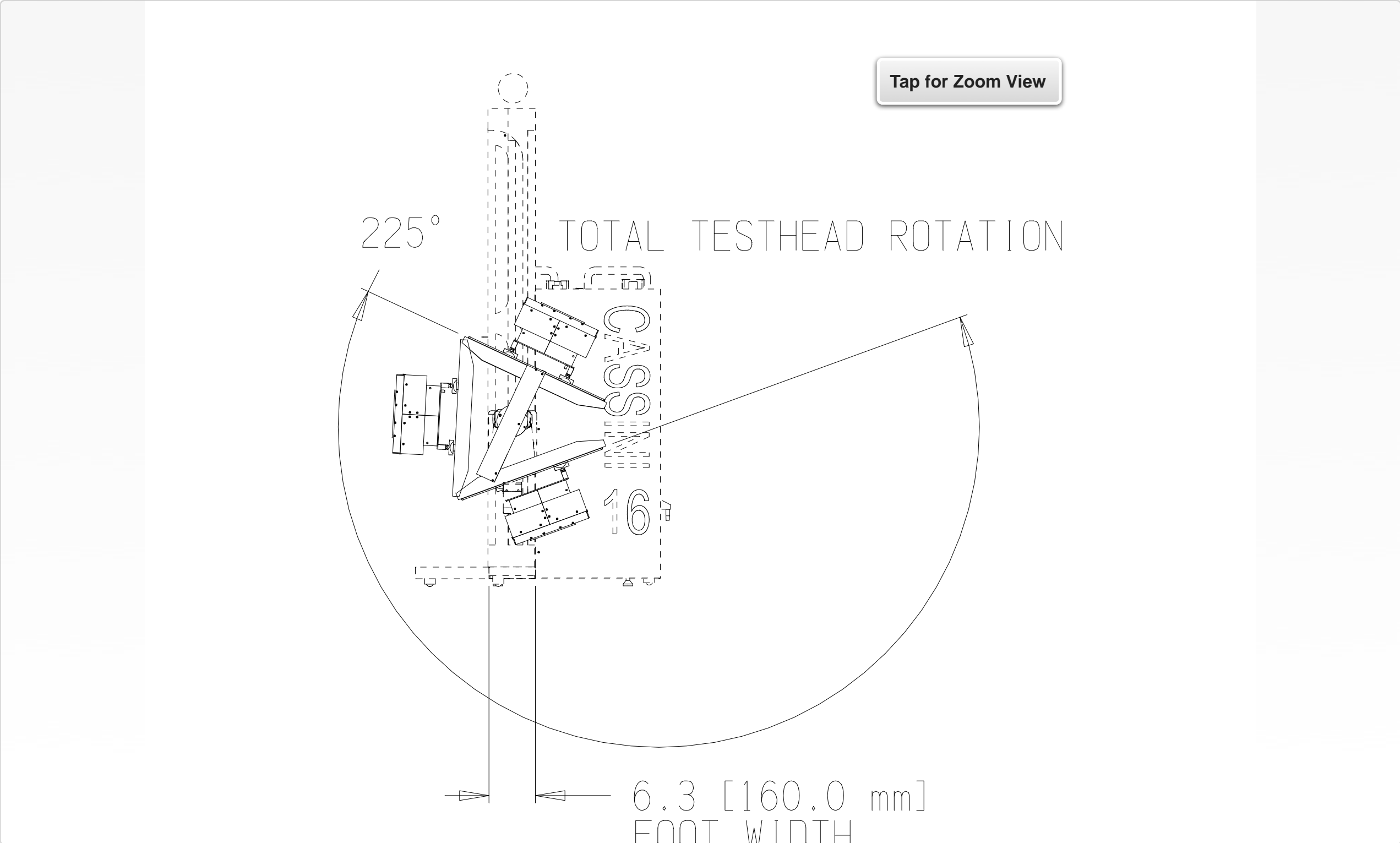


FIGURE 8.11 RI8568B TOP-VIEW WITH AUXILIARY CART (CONFIGURATION 1)

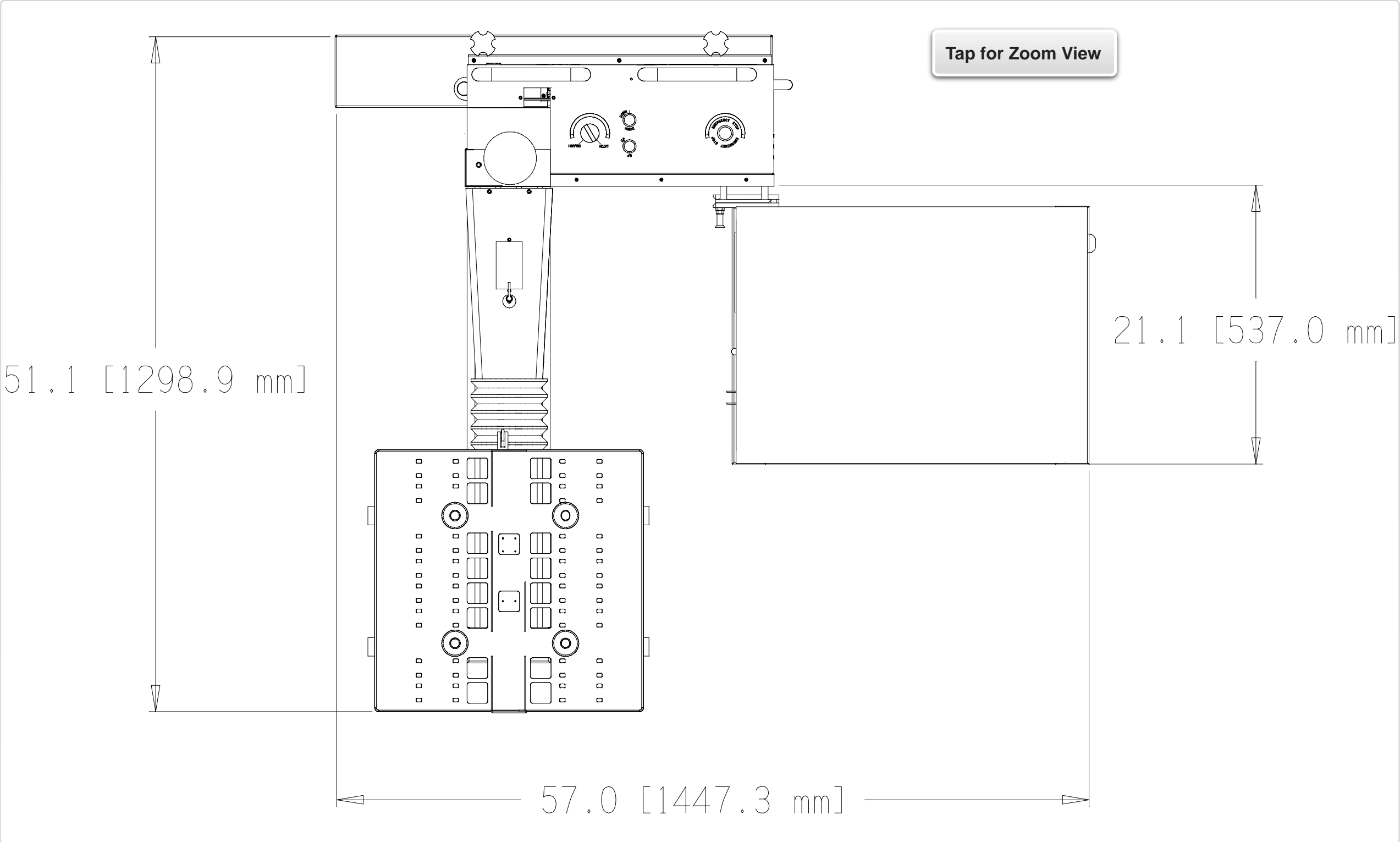


FIGURE 8.12 RI8568B TOP-VIEW WITH AUXILIARY CART (CONFIGURATION 2)

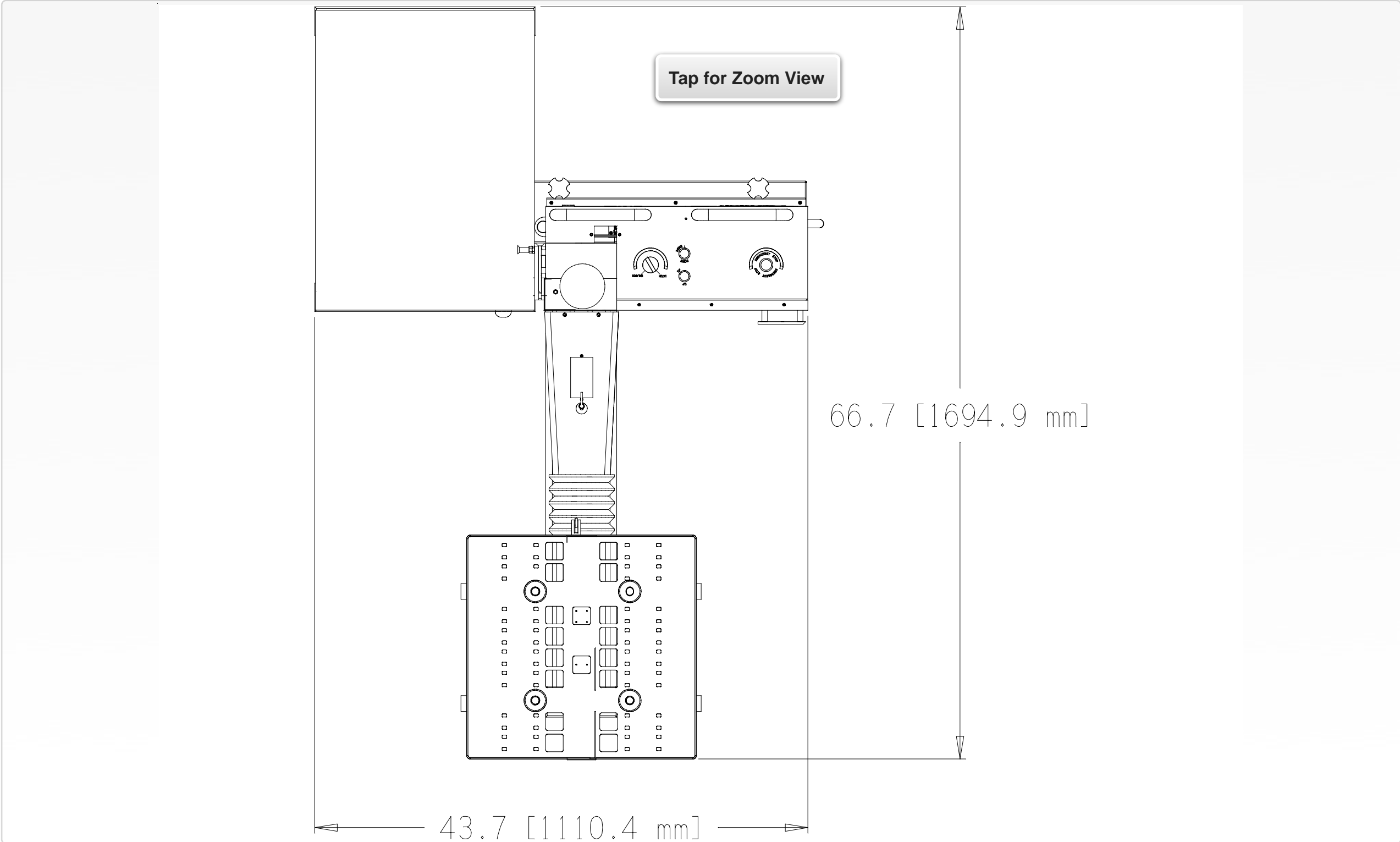
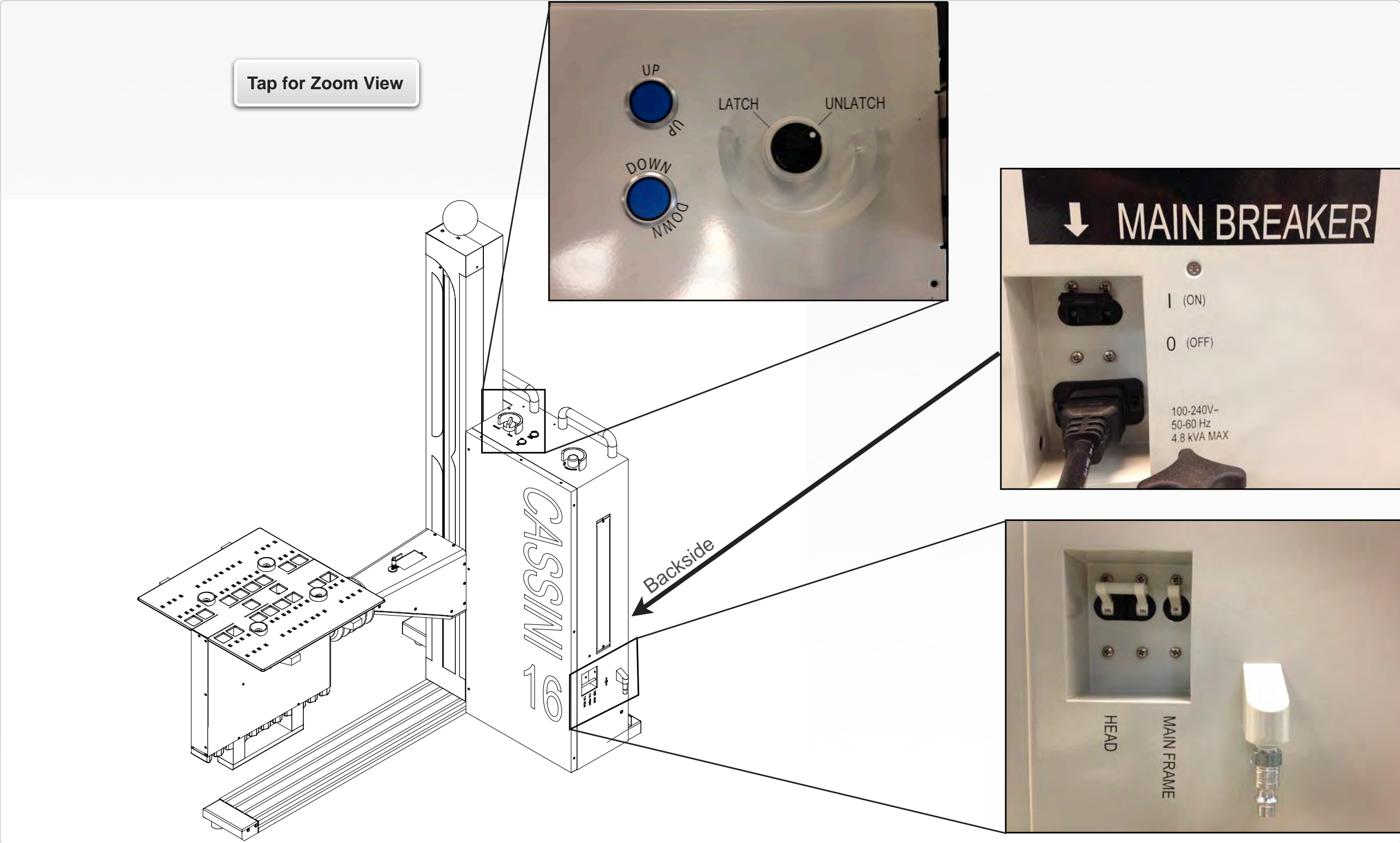


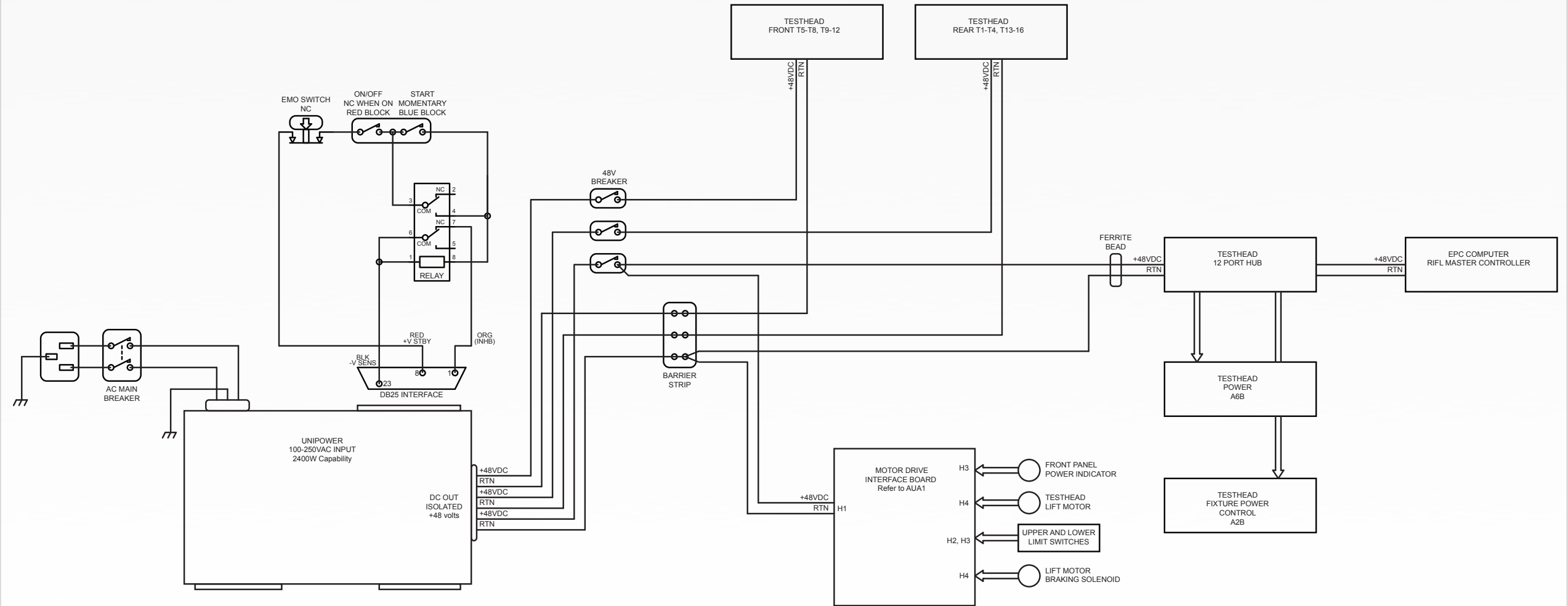
FIGURE 8.13 CIRCUIT BREAKERS AND FIXTURE DOCKING LATCH



### BLOCK DIAGRAM 8.11 TEST HEAD WIRING DIAGRAM

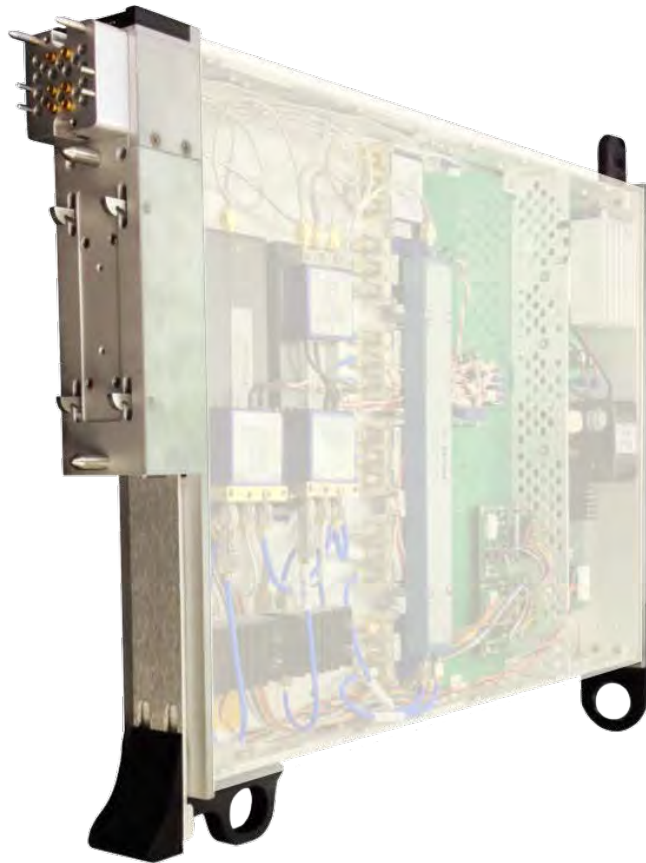

**Roos Instruments, Inc - Cassini16**  
**Block Diagram, Power Distribution**  
 Infrastructure, Rev 1  
 2014-06-22  
 Richard Doport  
 Copyright Roos Instruments, Inc.  
 Subject to change without notice

Tap for Zoom View





# RI8572: WAVEFORM GENERATOR & MEASURE



## DESCRIPTION

The RI8572 combines two dedicated waveform generators and a dual-channel digitizer in a single instrument for general purpose time domain measurements. A built-in PLL and direct digital synthesizer generates two channels of orthogonal CW signals with phase, amplitude and DC offset controls for single tone applications. An arbitrary waveform generator with an embedded FPGA supplies two, DC coupled outputs with sinusoidal, square-wave, and user-programmable, complex modulated signals for baseband applications. A separate DDS and lookup table engine drives two, AC coupled ports for dedicated sinusoidal signal generation. A dual-channel digitizer provides oscilloscope functionality with two high-speed ADCs and a dedicated FPGA for real-time signal analysis.

## KEY FEATURES

- M-ary QAM, M-PSK, & Custom Baseband Signals
- Continuous & Reciprocal Frequency Counter
- Measure S/N, SINAD, Rise / Fall Times

## INSTRUMENTS PROVIDED BY THIS TIM

The instrument in this TIM appear as **Oscilloscope**, **SineGen** and **Waveform** in the panel dialog windows.

Model and Name as it appears in the Tester Configuration:

- Oscilloscope, RI74105x Hi Spd scope/counter/BER
- SineGen, Ri7403x Dual Sine Source
- Waveform, Ri74211x Complex Waveform

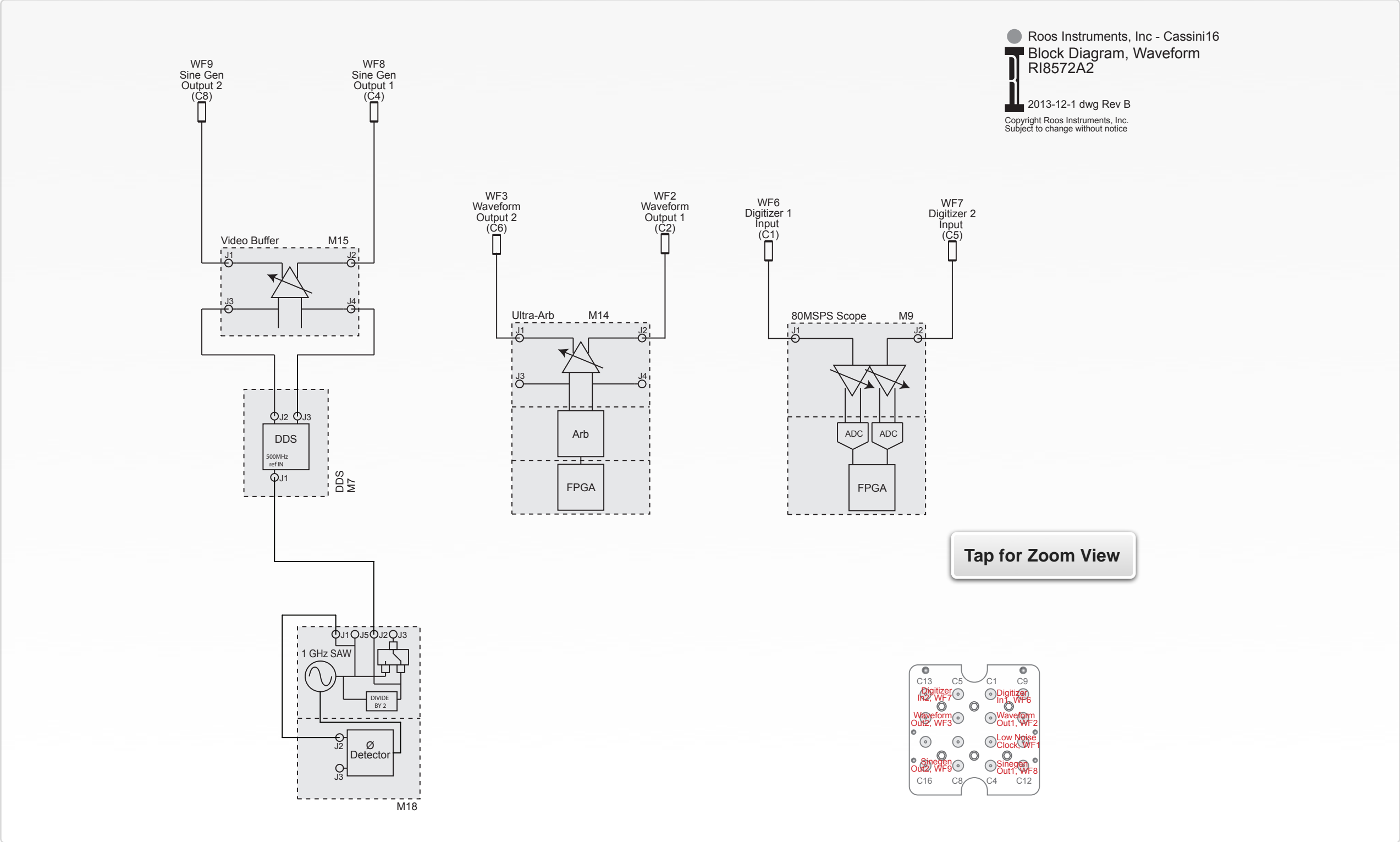
*NOTE: Multiple RI8594 instruments are enumerated incrementally by the system as “2”, “3”, etc. in the configuration, edit, and control panels (i.e - Oscilloscope, SineGen, Waveform; Oscilloscope2, SineGen2, Waveform2; Oscilloscope2, SineGen2, Waveform2; etc).*

*The “x” in RI8594x denotes the model revision number.*

## TIM OPERATIONS

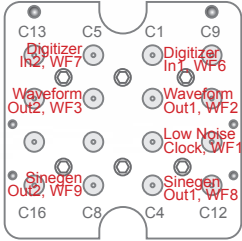
Reference the [RI8572 section](#) of the Graphical Programming chapter for configuration, edit and control panels.

BLOCK DIAGRAM 8.12



Roos Instruments, Inc - Cassini16  
 Block Diagram, Waveform  
 RI8572A2  
 2013-12-1 dwg Rev B  
 Copyright Roos Instruments, Inc.  
 Subject to change without notice

Tap for Zoom View



## PERFORMANCE SPECIFICATIONS

### Sine Wave Generator

---

Frequency Range 1 kHz to 90 MHz

Voltage Range 0.1 Vp-p to 3 Vp-p

### Arbitrary Wave Generator

---

Frequency Range 1 Hz to 100 MHz

Voltage Range 640 MHz (Max)

### Digitizer

---

Measurement Bandwidth 100 MHz

Signal/Bit Resolution  $\pm 0.4V$  / 14Bits

Sample Rate 80 Msps

---

This is an abbreviated list of instrument capability and is subject to change without notice. For comprehensive and up-to-date instruments specifications consult the TIM Specification document.

# RI8574: SYSTEM CONTROLLER



## DESCRIPTION

The System Controller TIM provides the embedded user interface, multi-instrument control, and graphical test programming environment for the Cassini ATE system. Instrument control and management are provided via the RIFL (Roos Instruments Fast Link) bus. RIFL provides the communication bus as well as distributing 48V instrument power and a shared 10 MHz reference clock across the instrument test head. The controller provides networked data storage and communication capabilities (Guru™) through a standard CAT-5 connections with local storage for online and offline development and USB ports for non-network data transfer. Guru™ provides tools for organizing files, data, and software test resources along with built-in file versioning, automated backups, data and test distribution control, access control and more.

## KEY FEATURES

- Embedded OS/2 based Operating System
- Cassini Operator Interface
- Graphical Test Plan Development Environment
- Guru™ - Networked Database System
- Support for Temptronics® TP04310A Temperature Controller

## INSTRUMENTS PROVIDED BY THIS TIM

The instruments in this TIM appear as an **DataSim** and **System** in the panel dialog windows.

Model and Name as it appears in the Tester Configuration:

- DataSim, Data Simulator
- System, System Resources 2

*NOTE: The “x” in the model number denotes the revision of the Instrument.*

Optional Instruments may include:

- (Optional) TempControl, Temptronics TP04310A Temperature Controller (or compatible)

## TIM OPERATIONS

Reference the [RI8574 section](#) of the Graphical Programming chapter for configuration, edit and control panels.

## RIFL MASTER

Roos Instruments Fast Link (RIFL) is a star topology communication bus that requires a single RIFL Master connected to RIFL Hubs and RIFL Nodes. RIFL Hubs are located in the Infrastructure and distribute power. Every TIM, Fixture Module, and Hander Pod is a RIFL Node.

The RIFL Master used for TIM communication, power and 10 MHz reference clock is contained in this TIM but does not appear in the Tester Configuration. The 10 MHz crystal oscillator is calibrated with an integer offset once at the factory and is expected to remain within tolerances for 25 years.



## PERFORMANCE SPECIFICATIONS

### Hardware

---

CPU	Intel Core2 Duo
RAM	2 GB DDR2 667 MHz
HDD	SSD 120 GB

### Operating System

---

ArcaOS or eComStation	Embedded OS, Graphical User Interface, Human Interface Controls
-----------------------	---

### Interface Ports

---

General IO	4 - USB, 1 - VGA (monitor), 2 - PS/2 (mouse & keyboard), 1- Serial, 1-Parallel
Handler/Prober/Temp Controller	Serial, Parallel, or GPIB
Graphical User Interface	Touchscreen and/or Monitor
Networking	10/100/1000 Ethernet, RJ45 Cat 5+
Network Standards	FTP, NSF, SMB, VNC, RSYNC, Telnet, NTP, LPD, SMB Printers, PDF

This is an abbreviated list of instrument capability and is subject to change without notice. For comprehensive and up-to-date instruments specifications consult the TIM Specification document.

# RI8575: PHASE NOISE MEASURE



## DESCRIPTION

The RI8575 Phase Noise measurement TIM provides Cassini with a direct Phase Noise test capability to handle microwave VCO's and Oscillators at production speeds. It includes two RF Measure ports and a multipurpose I/O port for biasing and phase locking the device under test, evaluating Kv, Linearity, FM side-band performance, and Phase Noise for devices operating from 100 kHz to 12 GHz.

## KEY FEATURES

- Phase Detector with built in Reference Oscillator
- Parametric Supply / Measure for Tune Voltage & Current
- Linearity & Kv Measure with 16-Bit Frequency Counter
- FM Sideband Measure

## INSTRUMENTS PROVIDED BY THIS TIM


The instrument in this TIM appear as **PhaseNoiseAnalyzer** in the panel dialog windows. (See [Graphical Programming](#) chapter)

Model and Name as it appears in the Tester Configuration:

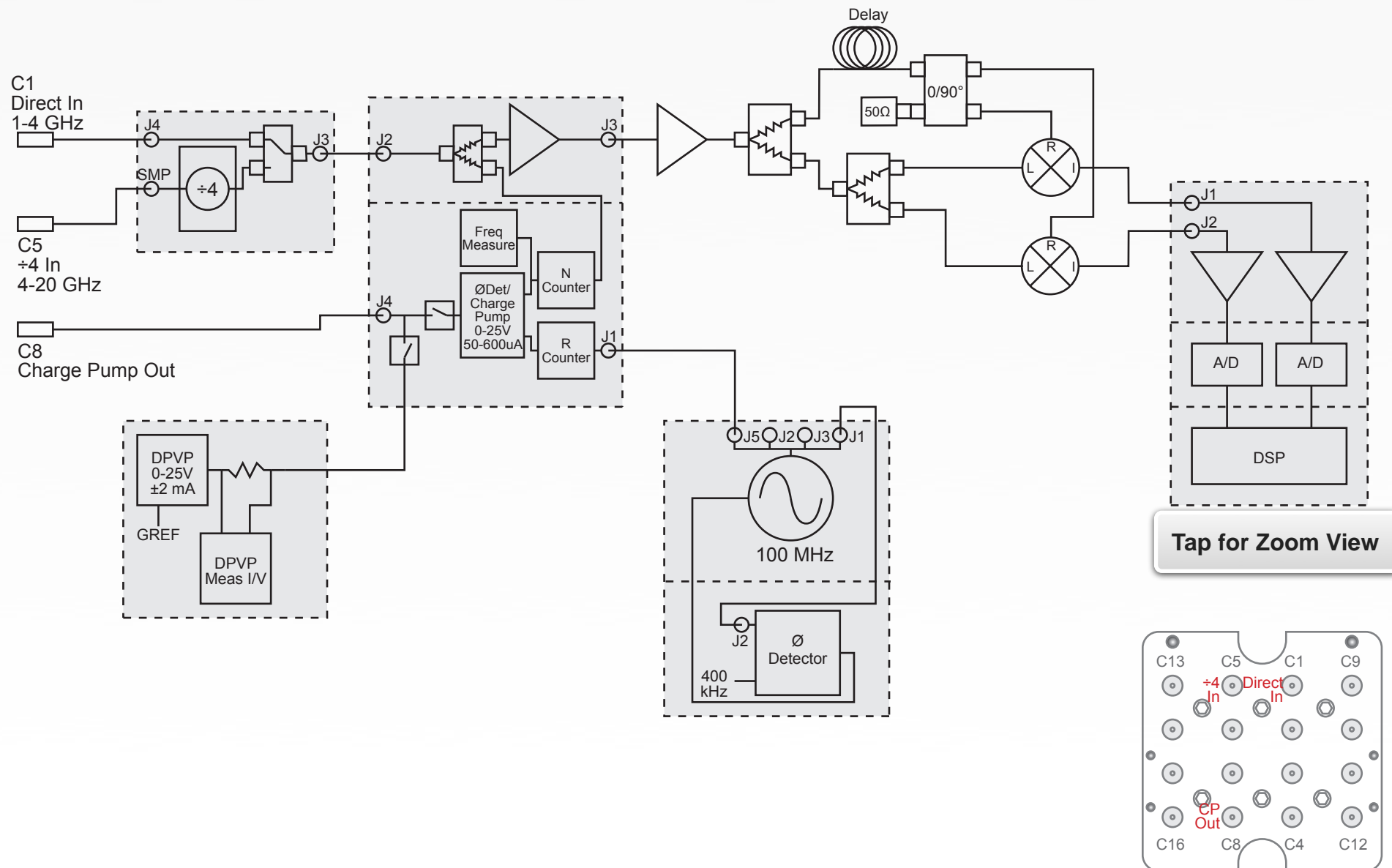
- PhaseNoiseAnalyzer, RI8575x 1 - 16 GHz Phase Noise Analyzer

*NOTE: Multiple RI8575 instruments are enumerated incrementally by the system as "2", "3", etc. in the configuration, edit, and control panels (i.e - PhaseNoiseAnalyzer, PhaseNoiseAnalyzer2, PhaseNoiseAnalyzer3, etc). The "x" in RI8575x denotes the model revision number.*

BLOCK DIAGRAM 8.13

 Roos Instruments, Inc - Cassini  
Block Diagram, Phase Noise Discriminator TIM  
RI8575A

2012-03-21  
Copyright Roos Instruments, Inc.  
Subject to change without notice



## PERFORMANCE SPECIFICATIONS

### Phase Noise Measure

---

Frequency Range	1 GHz to 16 GHz
Frequency Resolution	0.1 Hz
Frequency Offset	50 kHz to 2 MHz
Direct Noise Floor	-129 dBc/Hz @ 50 kHz -161 dBc/Hz @ 2 MHz
Divide-By-4 Noise Floor	-117 dBc/Hz @ 50 kHz -146 dBc/Hz @ 2 MHz

### Parametric Measure

---

Current Range	$\pm 2$ mA; $\pm 2$ $\mu$ A
Voltage Range	-3 V to +25 V

This is an abbreviated list of instrument capability and is subject to change without notice. For comprehensive and up-to-date instruments specifications consult the TIM Specification document.

# RI8577: SOURCE COMBINER



## DESCRIPTION

The RI8577 Source Combiner TIM provides add-in capability for microwave mixing of two independent microwave sources for the 200MHz to 20GHz frequency band. Built-in signal amplification of up to 1 Watt and variable attenuation to 110dB provide signal conditioning along with enhanced impedance matching and calibrated signal paths. Internal low-loss RF relays provide two-tone and independent source distribution to support multi-site schemes and multi-port resource sharing applications.

## KEY FEATURES

- 200 MHz to 20GHz Frequency Range
- Optimized for 2-tone Signal Measurements: IP3, IMD,
- Microwave Signal Mixing of Two Independent Sources
- Multi-path Signal Switching & Distribution
- Signal Conditioning: Gain, Attenuation, and Enhanced Impedance Matching

## INSTRUMENTS PROVIDED BY THIS TIM

The instrument in this TIM appear as **Src12Output** in the panel dialog windows. Additional TIMs appear as Src12Output# with # replaced by the number of TIM.

Model and Name as it appears in the Tester Configuration:

- Src12Output, Ri8577x Src1/2 Output TIM

*NOTE: Multiple RI8577 instruments are enumerated incrementally by the system as “2”, “3”, etc. in the configuration, edit, and control panels (i.e - Src12Output, Src12Output2, Src12Output3, etc). The “x” in RI8577x denotes the model revision number.*

## TIM OPERATIONS

Reference the [RI8577 section](#) of the Graphical Programming chapter for configuration, edit and control panels.

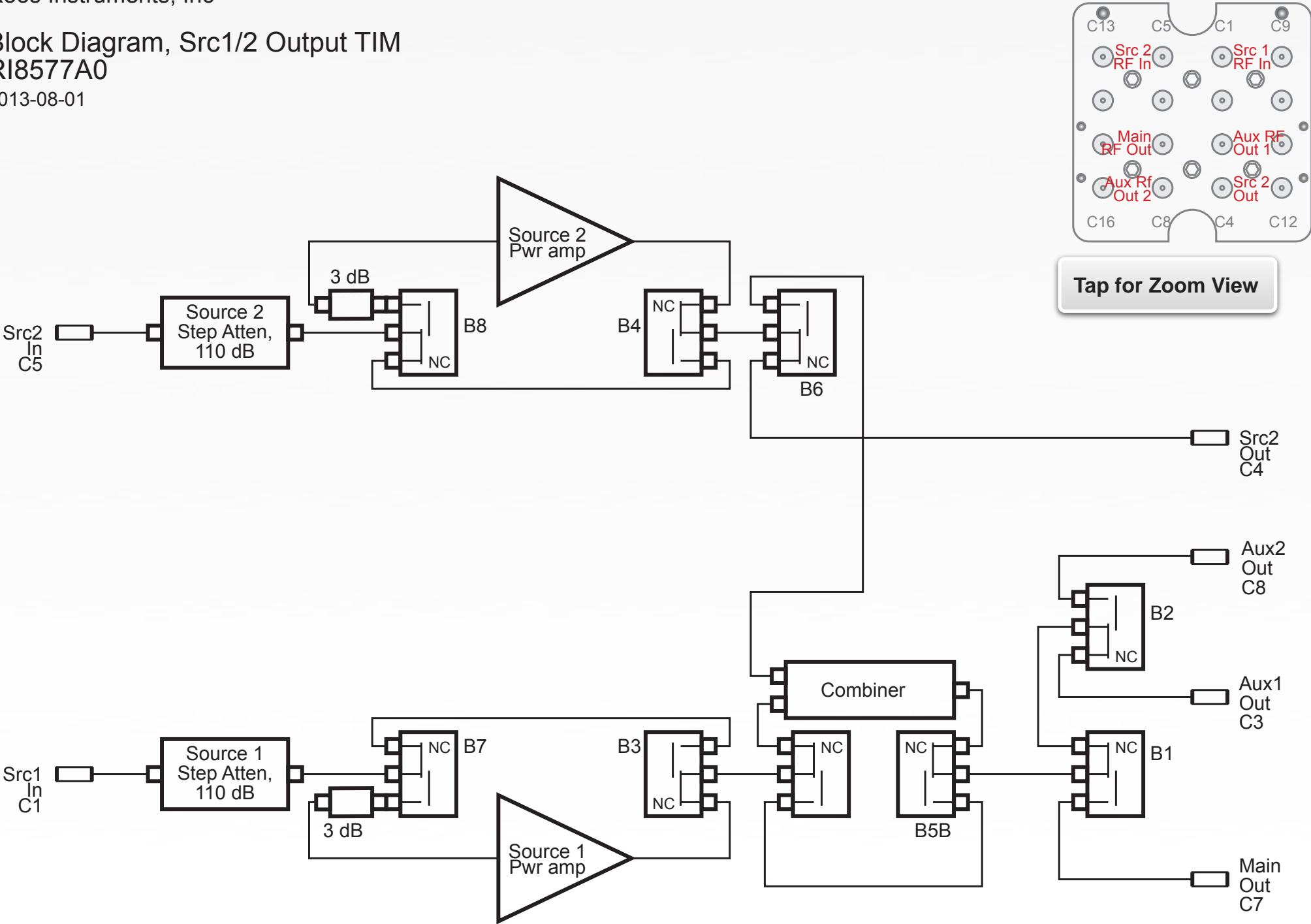


BLOCK DIAGRAM 8.14

Roos Instruments, Inc



Block Diagram, Src1/2 Output TIM  
RI8577A0  
2013-08-01



Tap for Zoom View

## PERFORMANCE SPECIFICATIONS

### Source

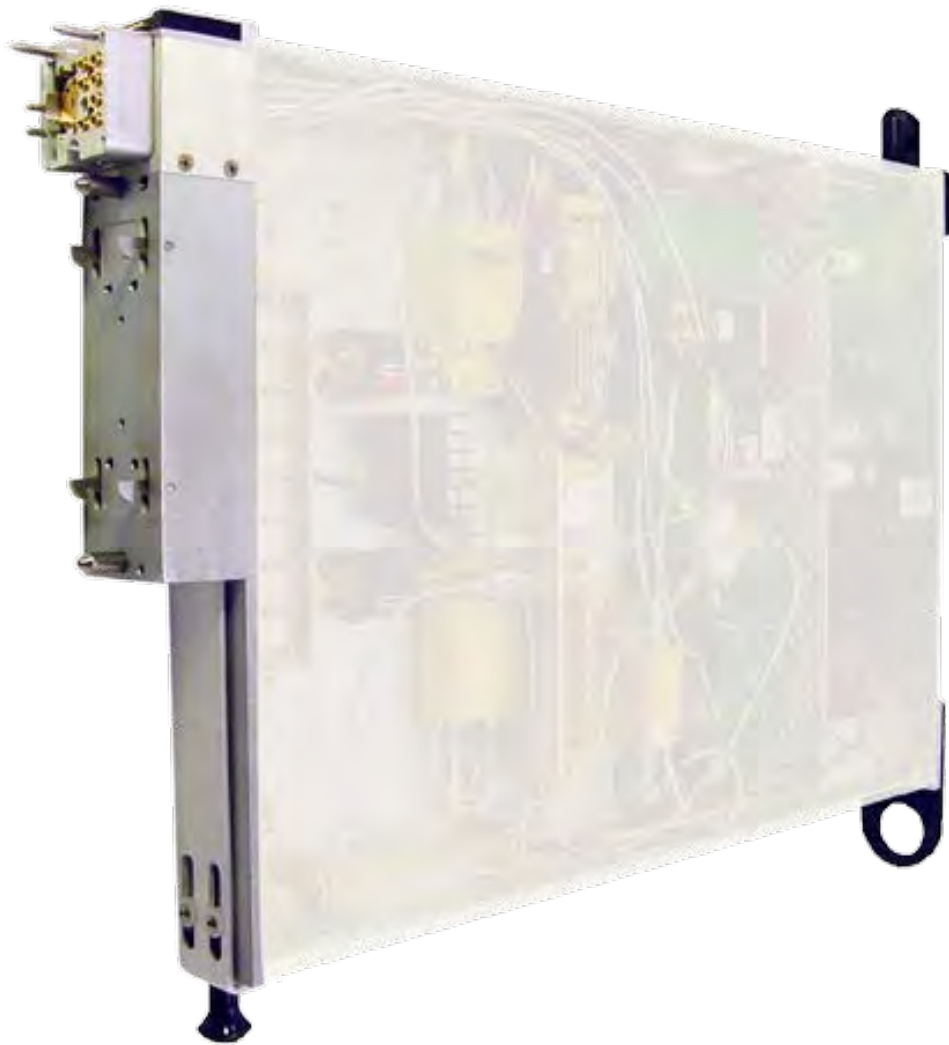
---

Frequency Range	10 MHz to 20 GHz
Amplifier Gain	20 dB (500 MHz to 6 GHz)
Power Range	-110 dBm to +30dBm
Power Accuracy	± 0.5 dB

---

This is an abbreviated list of instrument capability and is subject to change without notice. For comprehensive and up-to-date instruments specifications consult the TIM Specification document.

# RI8580: 57GHz TO 64GHz TESTSET



## DESCRIPTION

The RI8580 mmWave test port TIM extends the frequency and application capability of Cassini's vector measurements to the 57 GHz - 64 GHz range. Calibrated RF paths deliver precision source and measure of signal power, distortion test, s-parameters, and harmonic measurement. Designed to interface with a Cassini receiver and source instrument, the RI8580 can be shared across multiple mmWave I/O for fast, precision measurements and maximum channel utilization.

## KEY FEATURES

- S-Parameters from 57 GHz to 64 GHz
- NIST Calibrated Noise Source & Vector Error Correction
- Measure Noise Figure, P1dB, Abs. Power & Phase Noise
- Waveguide S-Parameter Port

## INSTRUMENTS PROVIDED BY THIS TIM

The instrument in this TIM appear as **Test Head66** in the panel dialog windows.

Model and Name as it appears in the Tester Configuration:

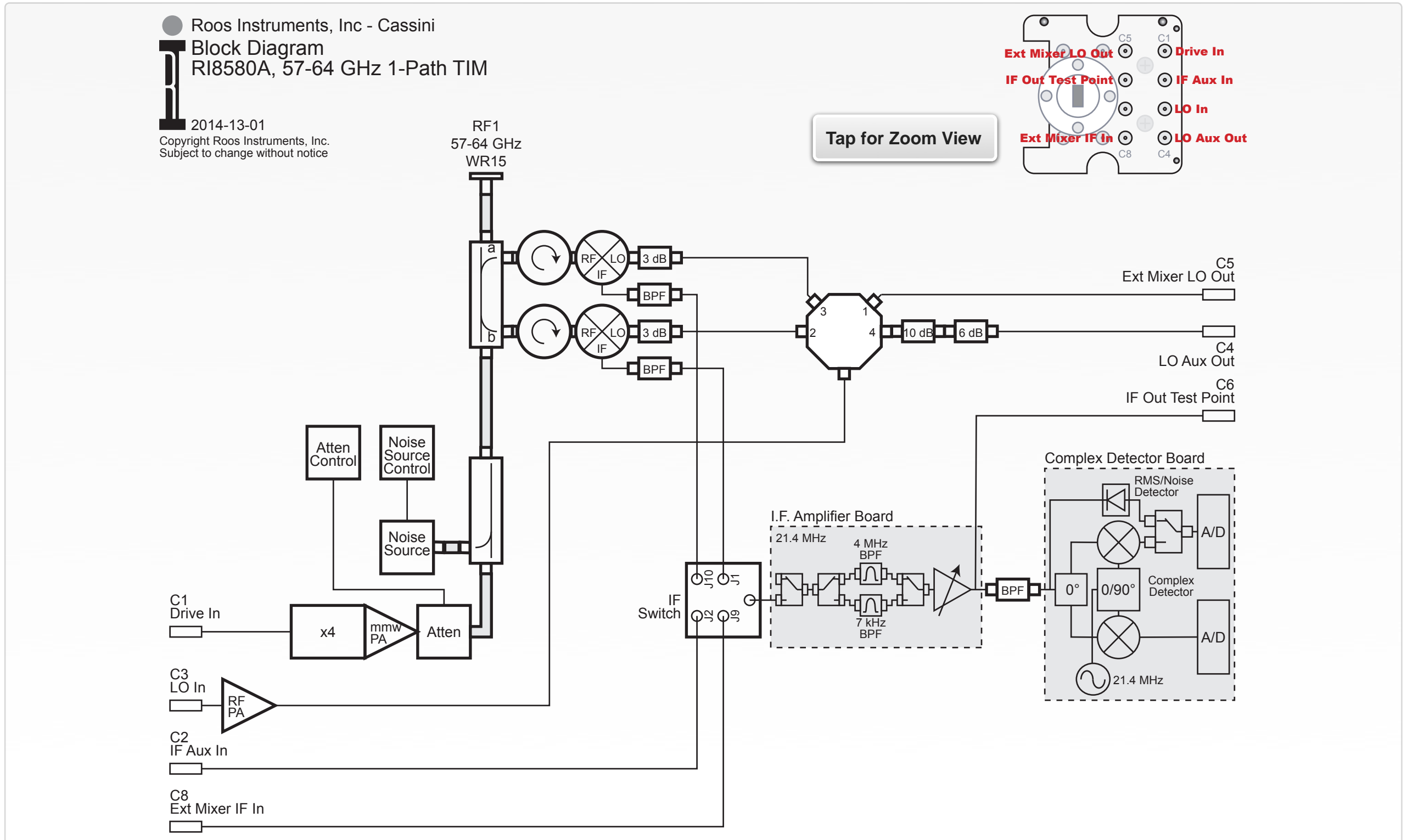
- Test Head66, RI8580x 66 GHz Test Set

*NOTE: Multiple RI8580 instruments are enumerated incrementally by the system as “2”, “3”, etc. in the configuration, edit, and control panels (i.e - Test Head66, Test Head662, Test Head663, etc). The “x” in RI8580x denotes the model revision number.*

## TIM OPERATIONS

Reference the [RI8580 section](#) of the Graphical Programming chapter for configuration, edit and control panels.

BLOCK DIAGRAM 8.15



## PERFORMANCE SPECIFICATIONS

### Source

---

Frequency Range	57 GHz to 64 GHz
Frequency Resolution	6 Hz
Power Range <sup>2</sup>	-20 dBm to +5 dBm
Power Accuracy	± 0.2 dB

### Measure

---

Frequency Range	57 GHz to 64 GHz
Power Range	-110 dBm to +10 dBm

This is an abbreviated list of instrument capability and is subject to change without notice. For comprehensive and up-to-date instruments specifications consult the TIM Specification document.

<sup>2</sup> Typical performance with an RI8587 Receiver



# RI8581: 100kHz TO 20GHz RECEIVER



## DESCRIPTION

The RI8581 Receiver TIM provides a scalable RF front-end and frequency downconverter, along with a vector baseband digitizer that covers the 100 kHz to 20 GHz frequency range. The RI8581 features multiple RF ports that interface with the Cassini's Testset Instruments to extend the frequency range of the front-end to 81 GHz and beyond. The synchrodyne (frequency domain, phase and magnitude) back-end provides precision vector measurements while the high-linearity mixers and selectable analog filter bank with 7 kHz to 5 MHz of instantaneous detection bandwidth at signal sensitivities down to -100 dBm. The TIM provides 3 IF input ports, dedicated low and high frequency input ports, LO distribution, 2 auxiliary bypass ports, and a dedicated 21.4 MHz IF output port for bench analysis, engineering, and debugging.

## KEY FEATURES

- Absolute Power, Phase, Noise Figure and S-Parameters
- >100 dB of Dynamic Range from 100 kHz to 20 GHz
- Dual Measurement Engines, True RMS & Vector I & Q
- 2 RF Input ports, 3 baseband inputs, and Receiver LO input

## INSTRUMENTS PROVIDED BY THIS TIM

The instrument in this TIM appear as **Receiver** in the panel dialog windows.

Model and Name as it appears in the Tester Configuration:

- Receiver, RI8581x .01 to 20 GHz Complex Receiver TIM

*NOTE: Multiple RI8581 instruments are enumerated incrementally by the system as “2”, “3”, etc. in the configuration, edit, and control panels (i.e - Receiver, Receiver2, Receiver3, etc). The “x” in RI8581x denotes the model revision number.*

## TIM OPERATIONS

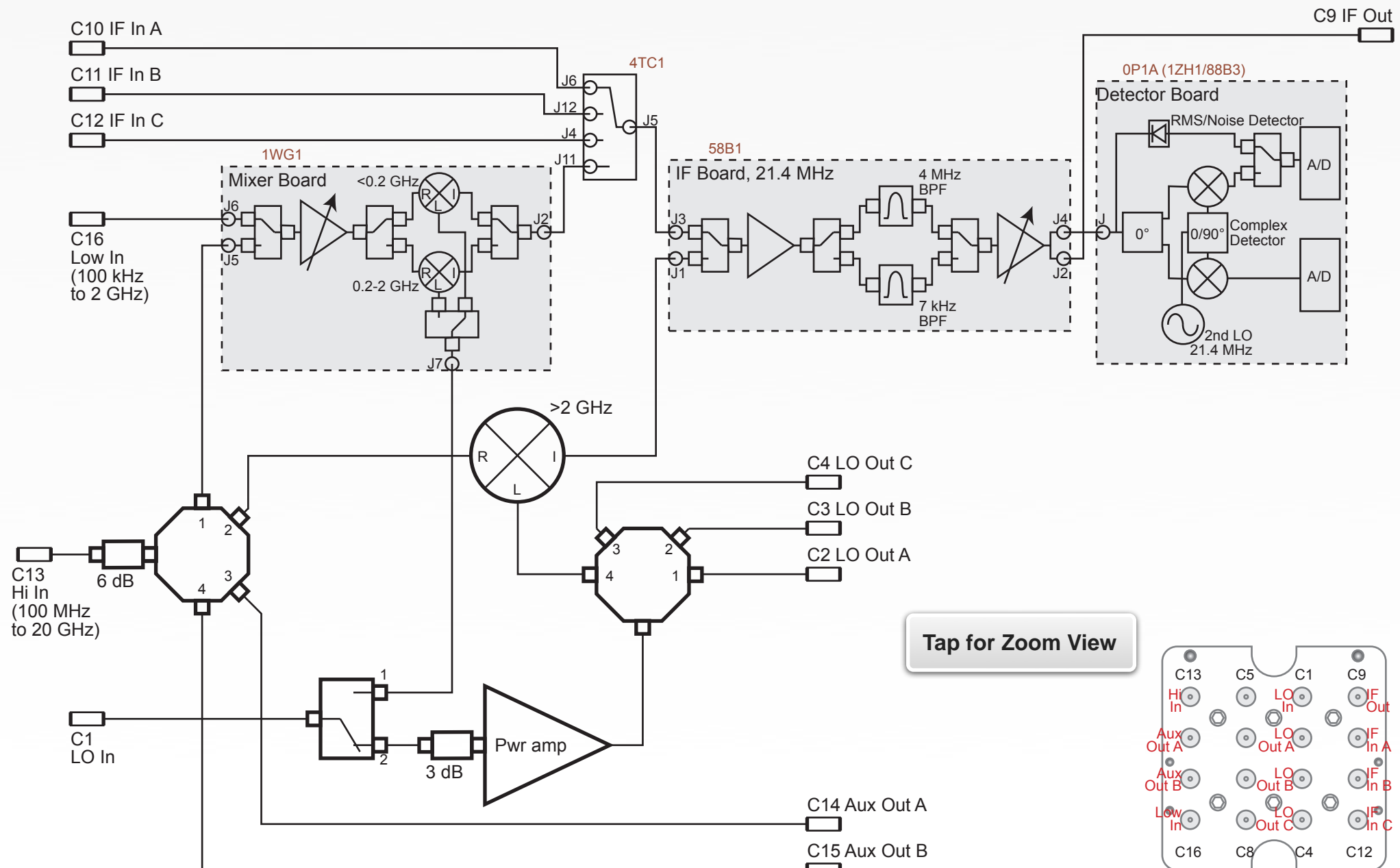
Reference the [RI8581 section](#) of the Graphical Programming chapter for configuration, edit and control panels.

BLOCK DIAGRAM 8.16

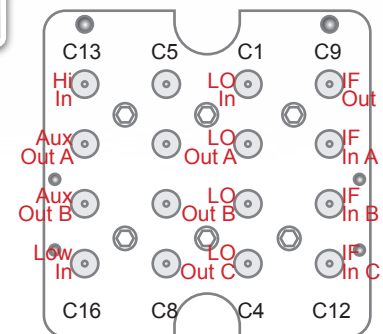
● Roos Instruments, Inc - Cassini  
**Block Diagram, Receiver TIM**  
**RI581A2**

2011-10-25

Copyright Roos Instruments, Inc.  
 Subject to change without notice



Tap for Zoom View



## PERFORMANCE SPECIFICATIONS

### Front-End

---

Frequency Range	100 kHz to 20 GHz
Frequency Resolution	1 Hz
Power Range <sup>2</sup>	-100 dBm to +10 dBm
Frequency Lock	<100 $\mu$ sec

### Receiver

---

Analog Bandwidths	7 kHz, 200 kHz, 5 MHz (user Selectable)
Noise Floor	-155 dBm/ Hz @ 1 GHz (typical)
ADC Sample Rate	80 MSps

---

This is an abbreviated list of instrument capability and is subject to change without notice. For comprehensive and up-to-date instruments specifications consult the TIM Specification document.

<sup>2</sup> Typical performance with an RI8587 Receiver

# RI8587: 100kHz TO 20GHz RECEIVER WITH DSP



## DESCRIPTION

The RI8587 Receiver TIM provides a scalable RF front-end and frequency downconverter, along with a vector baseband digitizer that has a local DSP for customized applications in the 100 kHz to 20 GHz frequency range. Incorporating our SyRF Core technology, the RI8587 features multiple RF ports that interface with the Cassini's Testset Instruments to extend the frequency range of the front-end to 81 GHz and beyond. The complex synchrodyne back-end provides high-linearity mixers, selectable analog filter bank with up a range of 1 kHz to 7 MHz of instantaneous detection bandwidth, and dual high-precision ADC's with an embedded FPGA for real-time spectrum analysis, digital filtering, demodulation and user-defined signal processing. The TIM provides 3 IF input ports, dedicated low and high frequency input ports, LO distribution, 2 auxiliary bypass ports, and a dedicated 21.4 MHz IF output port for bench analysis, engineering, and debugging.

## KEY FEATURES

- Absolute Power, Phase, Noise Figure and S-Parameters
- >100 dB of Dynamic Range from 100 kHz to 20 GHz
- Real-time DSP for Custom, PAR, ACPR, EVM, and FFTs
- 2 RF Input ports, 3 baseband Inputs, and Reference LO Input

## INSTRUMENTS PROVIDED BY THIS TIM

The instrument in this TIM appear as **Receiver** in the panel dialog windows.

Model and Name as it appears in the Tester Configuration:

- Receiver, RI8587x .01 to 20GHz Complex Receiver TIM w DSP

*NOTE: Multiple RI8587 instruments are enumerated incrementally by the system as “2”, “3”, etc. in the configuration, edit, and control panels (i.e - Receiver, Receiver2, Receiver3, etc). The “x” in RI8587x denotes the model revision number.*

## TIM OPERATIONS

Reference the [RI8587 section](#) of the Graphical Programming chapter for configuration, edit and control panels.

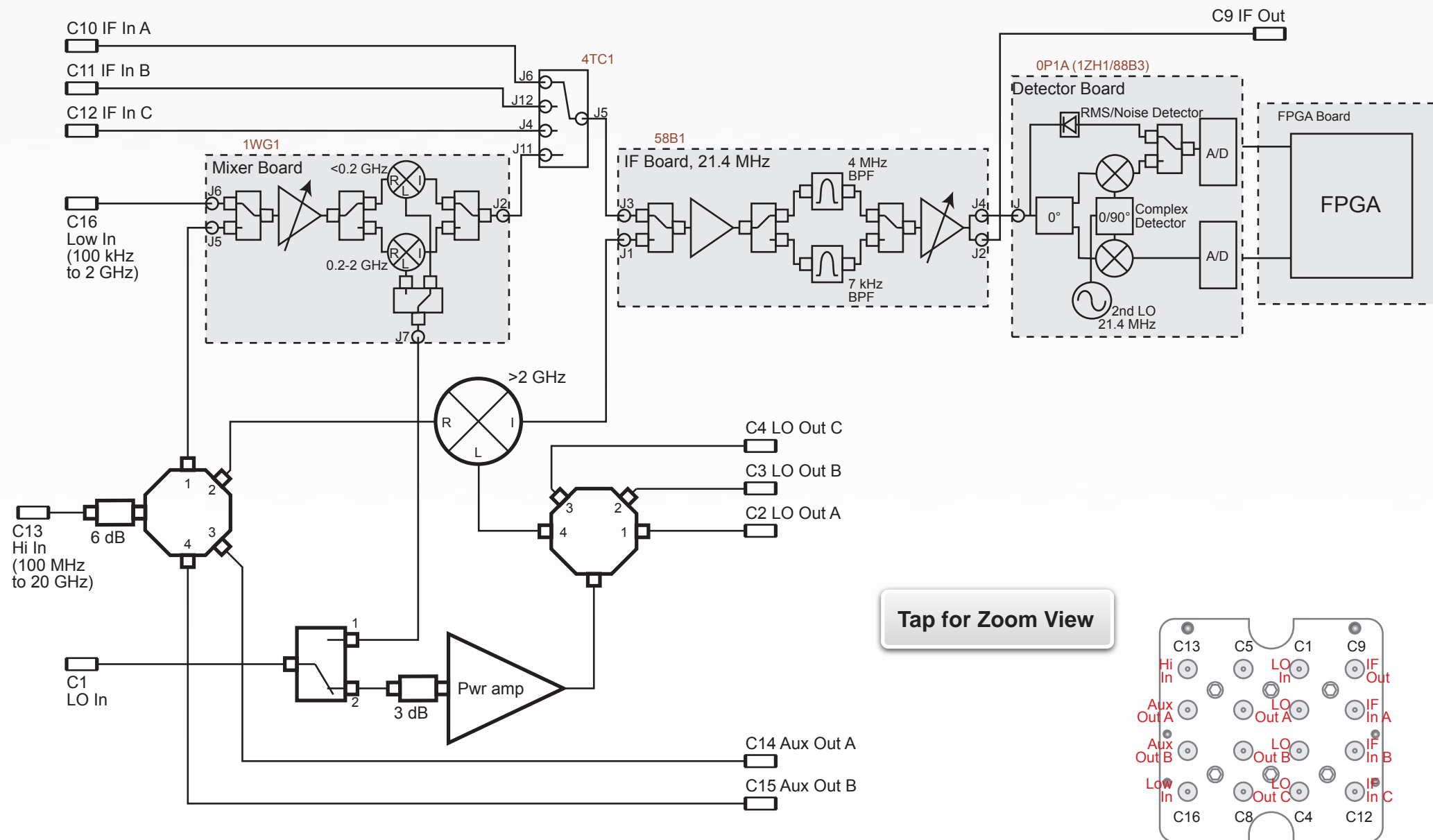


BLOCK DIAGRAM 8.17

● Roos Instruments, Inc - Cassini  
**Block Diagram, Receiver TIM  
 RI587A**

2014-01-13

Copyright Roos Instruments, Inc.  
 Subject to change without notice



Tap for Zoom View

## PERFORMANCE SPECIFICATIONS

### Front-End

---

Frequency Range	100 kHz to 20 GHz
Frequency Resolution	1 Hz
Power Range	-100 dBm to +10 dBm
Frequency Lock	<100 $\mu$ sec

### Receiver

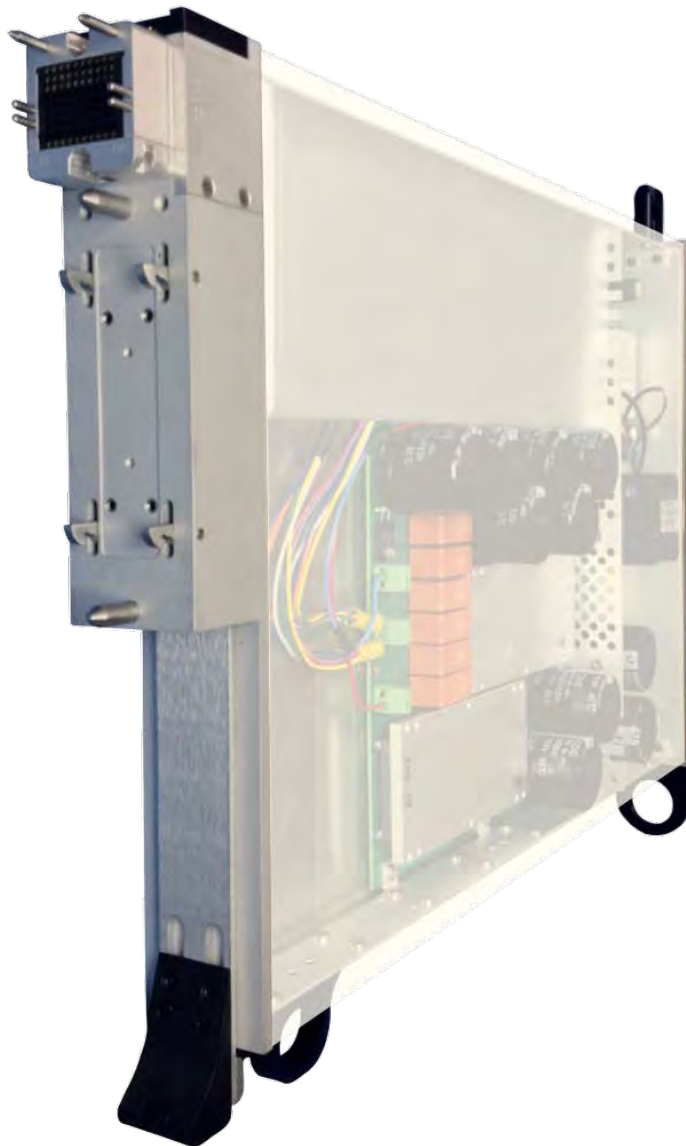
---

Analog Bandwidths	7 kHz, 200 kHz, 5 MHz (user Selectable)
Noise Floor	-155 dBm/Hz @ 1 GHz (typical)
ADC Sample Rate	80 Msps

---

This is an abbreviated list of instrument capability and is subject to change without notice. For comprehensive and up-to-date instruments specifications consult the TIM Specification document.

# RI8589: HIGH POWER SUPPLY/PULSER



## DESCRIPTION

The RI8589 FET Pulser provides power device parametric measurement, characterization, and high power drive supply. With a measurement range from sub- $\mu\text{A}$  to 200V/20A, this instrument allows evaluation of power FETs, BJTs, and IGBT devices as well as wide band-gap materials such as GaN and SiC. The RI8589 enables precise, small on-resistance measurements and 10 $\mu\text{s}$  fast pulse capability for complete power device characterization, temperature stress, and failure analysis.

## KEY FEATURES

- DC Parametric Measure & High-Power Supply in One Instrument
- High-Power Polarity Switching without Recabling
- 10 $\mu\text{s}$ , 500W High Power Pulse Capability
- 8 Control Pins for External Relays
- Built-in Fixture Safety Interlock Pins

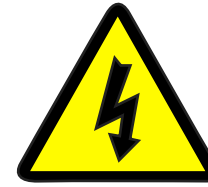
## INSTRUMENTS PROVIDED BY THIS TIM

The instrument in this TIM appear as **FetPulser** in the panel dialog windows.

Model and Name as it appears in the Tester Configuration:

- FetPulser, RI8589x Fet Pulser

*NOTE: Multiple RI8589 instruments are enumerated incrementally by the system as “2”, “3”, etc. in the configuration, edit, and control panels (i.e - FetPulser, FetPulser2, FetPulser3, etc). The “x” in RI8589x denotes the model revision number.*



## HAZARDOUS VOLTAGES

The RI8589 High Power Supply/Pulser instrument can produce DC and pulse voltages in excess of 170V. It is equipped with safety interlock pins that require a fixture Device Interface Board connection to enable high-power voltages at the output pins of the instrument. Always use certified Roos Instrument’s interfaces and interconnect with this instrument.

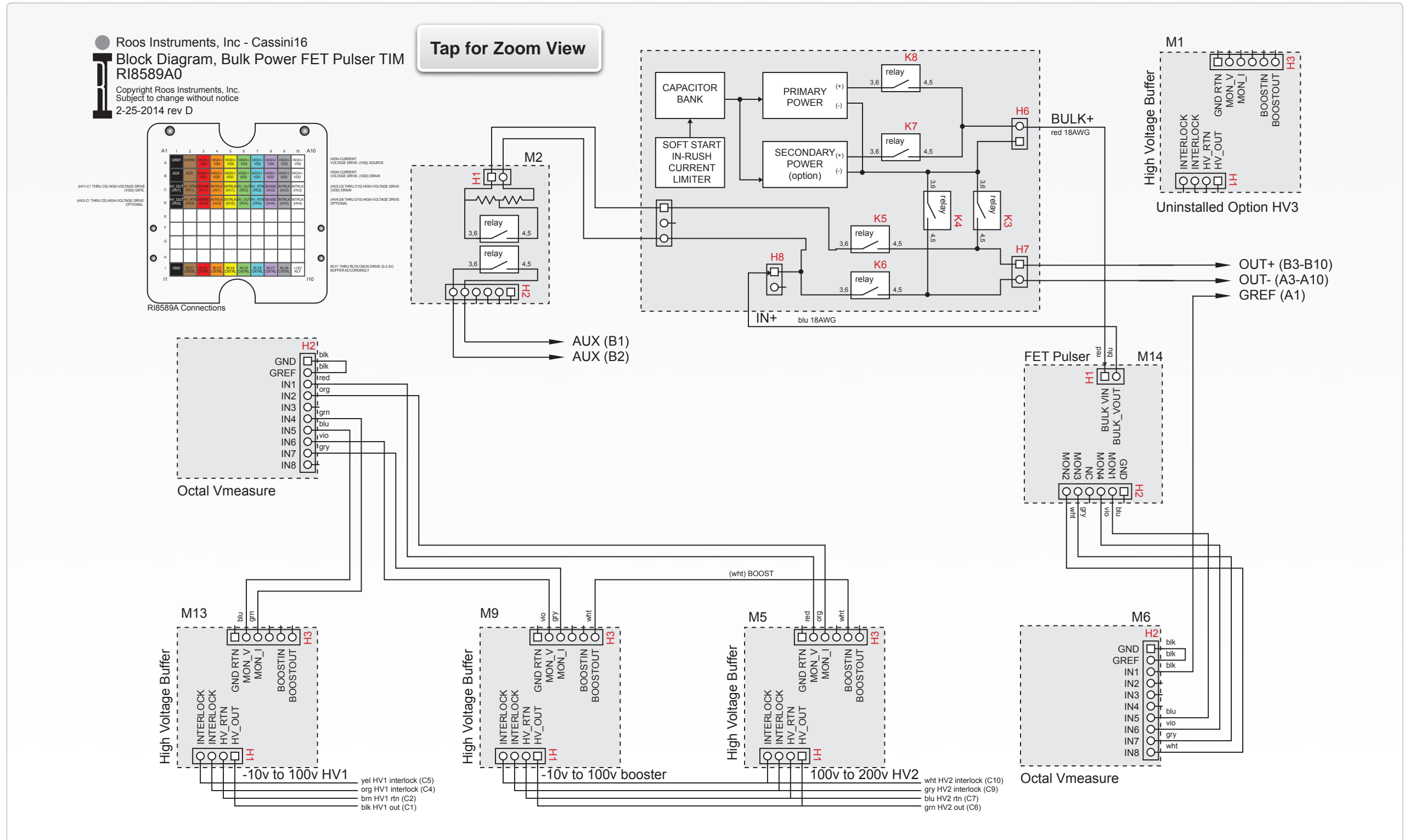
---

**WARNING: Always power down and remove this instrument before performing any service to the instrument, fixture, DIB, or test system. Never remove or service the device interface board or Quick Lock DIB system while the instrument is powered on.**

---

## DIAGNOSTIC REQUIREMENTS

BLOCK DIAGRAM 8.18



## PERFORMANCE SPECIFICATIONS

Supply	Gate Bias (HV1   HV3)	Drain Bias (HV2)	Drain Pulsing (High-I VDD/High-I VSS)	Drain Reverse Diode Test
$V_{MAX}$   $V_{MIN}$	+60 V   -10 V	175 V   -10V	50 V   8 V	-5 V   -50 V
$V_{SET}$ Resolution	5 mV	20 mV	20 mV	-
$I_{MAX}$	10 mA	10 mA	20 A	10 A
Settling Time	10 $\mu$ s	10 $\mu$ s	10 $\mu$ s to 100 ms (pulse)	10 $\mu$ s
<b>Measure</b>				
Range	1 $\mu$ A to 100 mA	1 $\mu$ A to 10 mA	10 mA to 20 A	-10 mA to +10 mA
Accuracy	0.1%	0.2%	0.3%	0.1%
Meas. Rate	80 ksps	80 ksps	80 ksps	80 ksps
$R_{OUT}$	100 $\Omega$   1 k $\Omega$ <sup>1</sup>	100 $\Omega$   1 k $\Omega$ <sup>1</sup>	0.04 $\Omega$	2.5 $\Omega$

This is an abbreviated list of instrument capability and is subject to change without notice. For comprehensive and up-to-date instruments specifications consult the TIM Specification document.

<sup>1</sup> Current measurements below 100  $\mu$ A use 1 k $\Omega$



# RI8594: HIGH PERF. WAVEFORM GENERATOR & MEASURE



## DESCRIPTION

The RI8594 delivers enhanced waveform and oscilloscope performance over the RI8572 Waveform/Measure instrument and includes an additional, low-noise clock source. The high-performance PLL supplies an optimal local oscillator reference signal for devices requiring high-fidelity phase noise qualification. The TIM includes a complex sine and arbitrary baseband waveform generator for modulated signal applications with two, DC coupled ports. A sine wave generator that uses a dedicated DDS and lookup table engine with two, AC coupled ports, as well as a dual-channel digitizer with an embedded FPGA for real-time oscilloscope measurements.

## KEY FEATURES

- M-ary QAM, M-PSK, & Custom Baseband Generation
- Continuous & Reciprocal Frequency Counter
- Measure S/N, SINAD, Rise/Fall Times
- Ultra Low-Noise Reference LO

## INSTRUMENTS PROVIDED BY THIS TIM

The instruments in this TIM appear as **LowNoiseClock**, **Oscilloscope**, **SineGen**, and **Waveform** in the panel dialog windows.

Model and Name as it appears in the Tester Configuration:

- LowNoiseClock, Ri8585x Low Noise Source
- Oscilloscope, RI74105x Hi Spd scope/counter/BER
- SineGen, Ri7403x Dual Sine Source
- Waveform, Ri74211x Complex Waveform

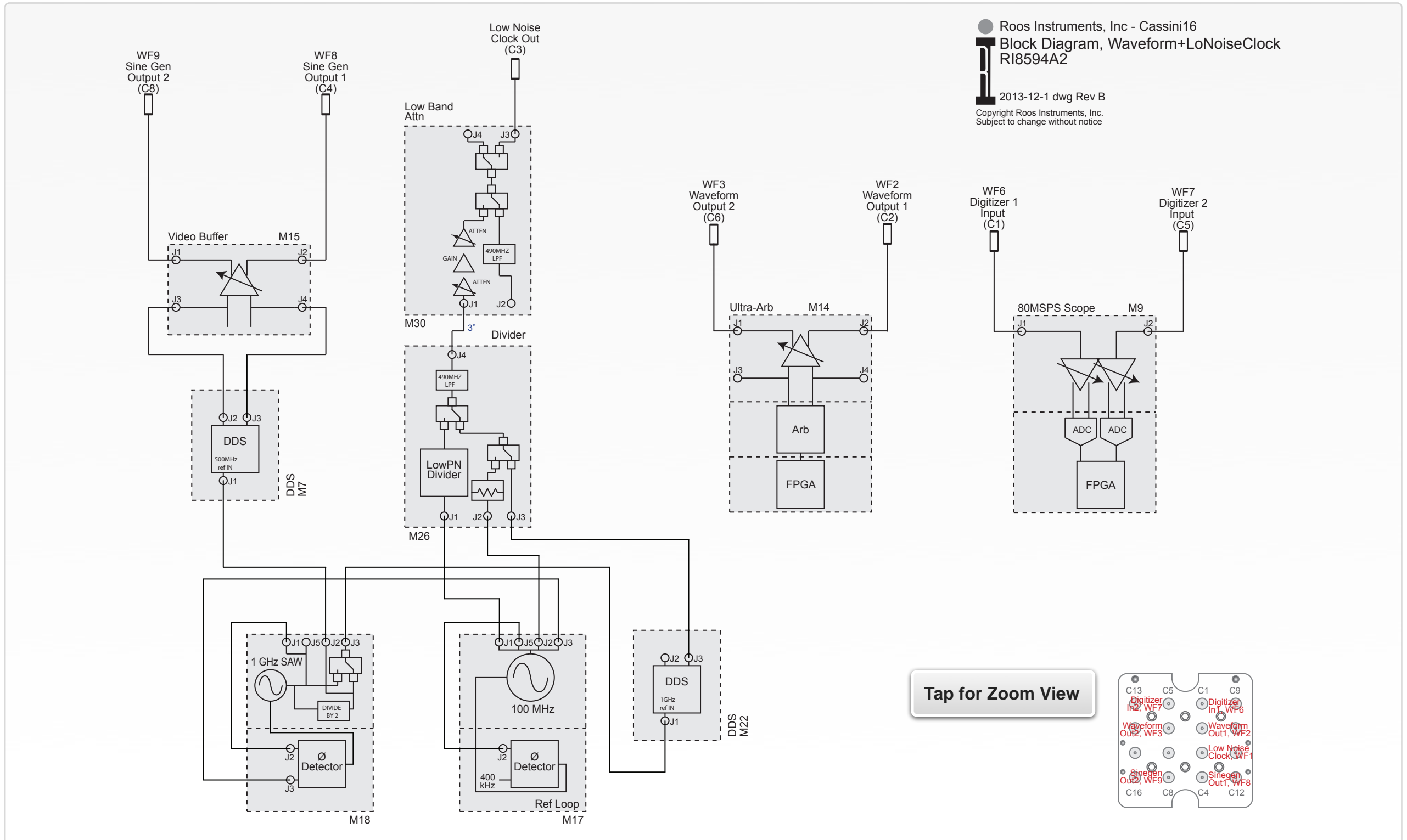
*NOTE: Multiple RI8594 instruments are enumerated incrementally by the system as “2”, “3”, etc. in the configuration, edit, and control panels (i.e - Oscilloscope, SineGen, Waveform, LowNoiseClock; Oscilloscope2, SineGen2, Waveform2, LowNoiseClock2; Oscilloscope2, SineGen2, Waveform2, LowNoiseClock2, etc).*

*The “x” in RI8594x denotes the model revision number.*

## TIM OPERATIONS

Reference the [RI8594 section](#) of the Graphical Programming chapter for configuration, edit and control panels.

BLOCK DIAGRAM 8.19



## PERFORMANCE SPECIFICATIONS

### Low Noise Clock

Frequency Options	100 MHz ÷ 2,4,5,8,10,16,20   100 MHz   200 Hz - 400 MHz
Phase Noise <sup>1</sup>	170 dBc/Hz   148 dBc/Hz   120 dBc/Hz

### Sine & Arbitrary Wave Generator

Frequency Range	1 kHz to 100 MHz (Sine)   1 Hz to 80 MHz (Arb.)
Clock Rate	640 MHz (Max)
Bit Resolution	16 Bits/Channel

### Digitizer

Analog Bandwidth	100 MHz
Voltage/Bit Resolution	±0.4 V / 14 Bits
Sample Rate	80 Msps

This is an abbreviated list of instrument capability and is subject to change without notice. For comprehensive and up-to-date instruments specifications consult the TIM Specification document.

<sup>1</sup> Typical performance at 20 kHz offset

# RI8595: 700MHz TO 6GHz POWER AMPLIFIER



## DESCRIPTION

The RI8595 RF Power Amplifier provides high-power signal output from 700 MHz to 6 GHz. Designed as a drop-in signal amplifier for the RI8508 RF Signal Generator, the unit provides up to 20 W of output power with calibrated signal paths and enhanced air cooling channels for stable thermal performance. The amplifier provides excellent gain linearity and flatness that is ideal for LDMOS, GaN cellular repeater ICs and other high-power RF applications.

## KEY FEATURES

- 700 MHz to 6000 MHz Frequency Range
- 20 W Maximum Output Power
- +50 dBm Typical IP3 Performance
- +42 dB In-band Signal Amplification

## INSTRUMENTS PROVIDED BY THIS TIM

The instrument is this TIM appears as **PowerAmp** in panel dialog windows.

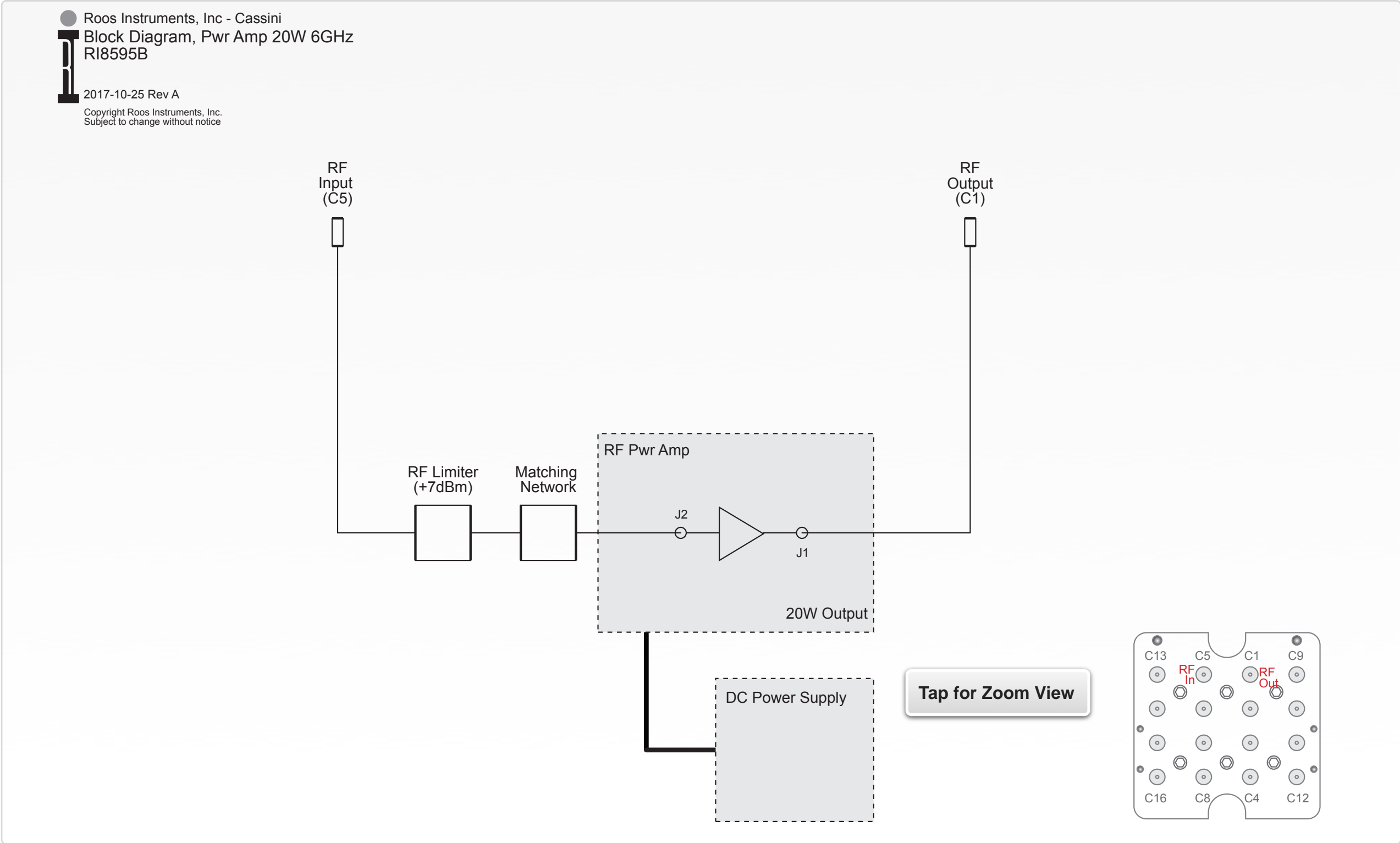
Model and Name as it appears in the Tester Configuration:

- PowerAmp, Ri8595B Pwr Amp 20W 6GHz

*NOTE: Multiple RI8595 instruments are enumerated incrementally by the system as “2”, “3”, etc. in the configuration panels (i.e - PowerAmp, PowerAmp2, PowerAmp3, etc).*



### BLOCK DIAGRAM 8.20



## PERFORMANCE SPECIFICATIONS

---

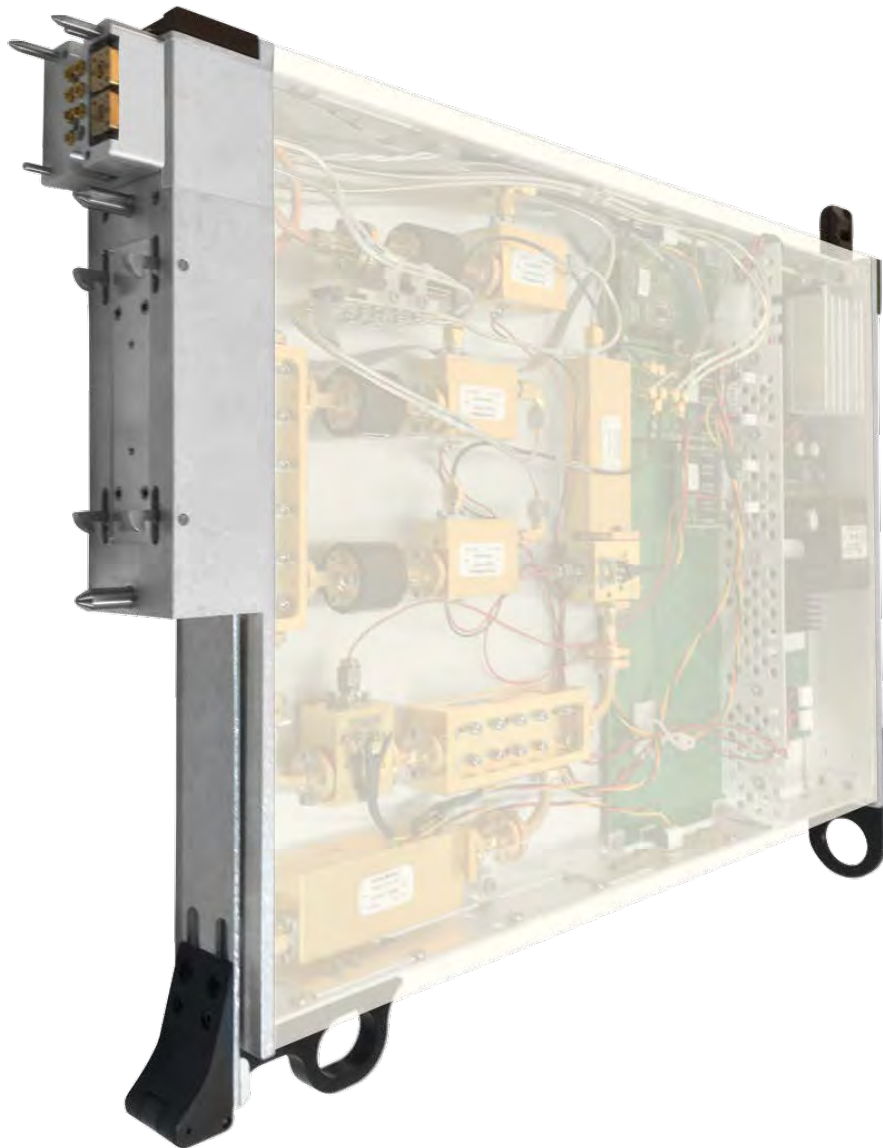
Frequency Range	700 MHz to 6000 MHz
Output Power	20 W (+43 dBm) Typical Maximum   10 W (+40dBm) at P1dB
Gain	42 dB (nominal)
Gain Flatness <sup>1</sup>	±1 dB
VSWR Input   Output	2:1   2:1

---

This is an abbreviated list of instrument capability and is subject to change without notice. For comprehensive and up-to-date instruments specifications consult the TIM Specification document.

<sup>1</sup> Typical performance with a calibrated RI8508 RF Source.

# RI8604: 71GHz TO 86GHz TESTSET



## DESCRIPTION

The RI8604 Test Set extends the frequency and application capability with a 2-port vector analyzer supporting the 71 - 86 GHz band. With both a bilateral and unilateral waveguide port, the instrument provides 2-tone source capability and measure of signal power, phase, return loss and forward gain s-parameters. Designed to integrate with a 20 GHz Cassini source and receiver, the test set instrument enables error-corrected calibration and vector measurements as well as providing auxiliary IF and LO ports to support external millimeter wave mixers for precision, thru-type measurements and extended test application flexibility.

## KEY FEATURES

- 2-Tone Source and Measure from 71 GHz to 86 GHz
- NIST-Traceable Vector Error Calibration
- Measures Power, Phase, Return Loss and Forward Gain
- Blind-Mate, Micro Flange Waveguide Interface


## INSTRUMENTS PROVIDED BY THIS TIM

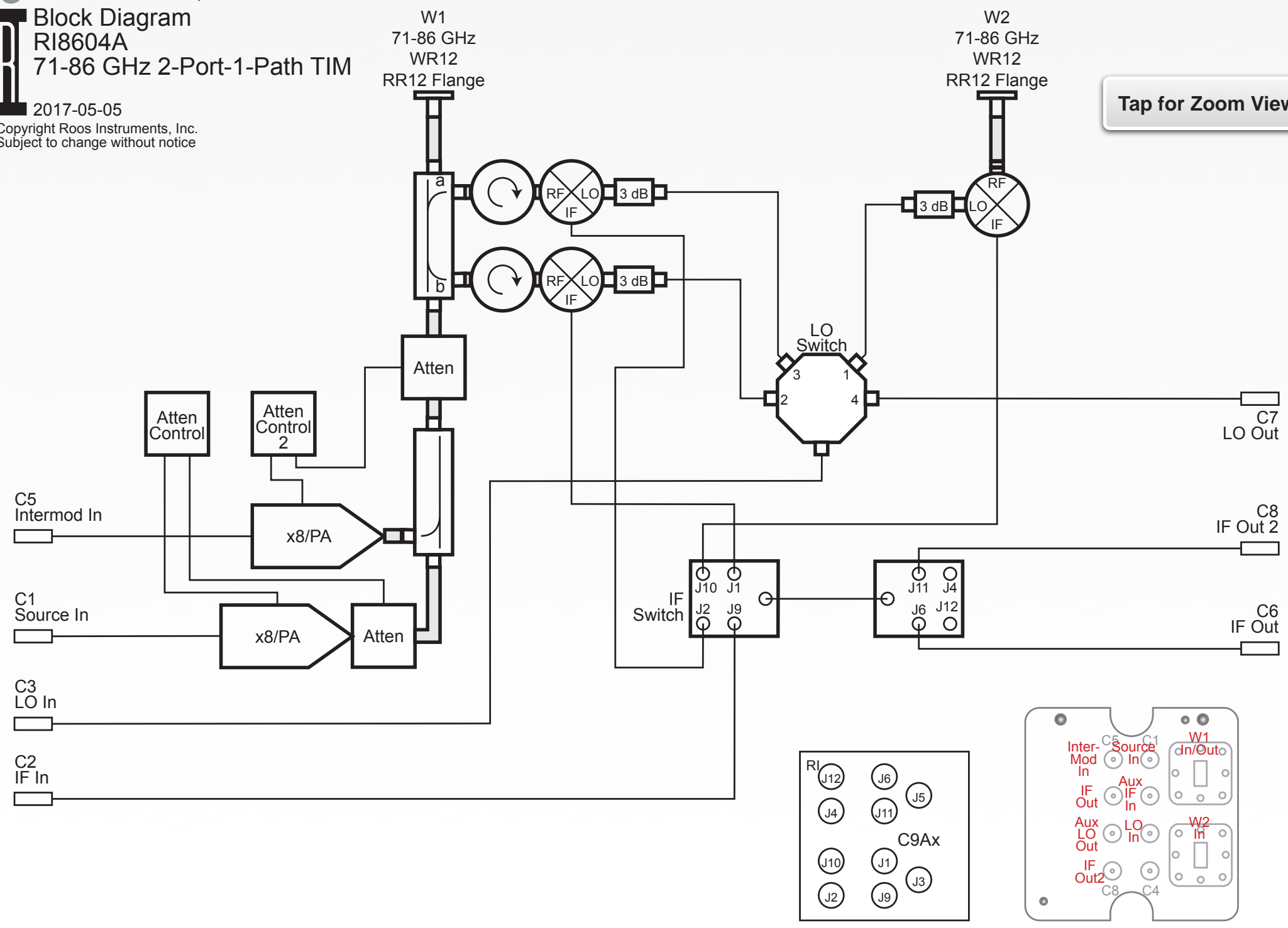
The instrument in this TIM appear as **Test Head77** in the panel dialog windows. Model and Name as it appears in the Tester Configuration:

- Test Head77, RI8604x 81 GHz Test Set

*NOTE: Multiple RI8604 instruments are enumerated incrementally by the system as “2”, “3”, etc. in the configuration, edit, and control panels (i.e - Test Head77, Test Head772, Test Head773, etc). The “x” in RI8604x denotes the model revision number.*

BLOCK DIAGRAM 8.21


 Roos Instruments, Inc - Cassini  
**Block Diagram**  
**RI8604A**  
**71-86 GHz 2-Port-1-Path TIM**  
 2017-05-05  
 Copyright Roos Instruments, Inc.  
 Subject to change without notice



Tap for Zoom View

## PERFORMANCE SPECIFICATIONS

### Source

---

Frequency Range	71 GHz to 86 GHz
Frequency Resolution	8 Hz
Power Range (Main)	-85 dBm to +5 dBm
Power Range (IM)	-55 dBm to +5 dBm

### Measure

---

Frequency Range	71 GHz to 86 GHz
Power Range <sup>1</sup>	-110 dBm to +10 dBm
Sensitivity (W1)	-110 dBm
Sensitivity (W2)	-130 dBm

This is an abbreviated list of instrument capability and is subject to change without notice. For comprehensive and up-to-date instruments specifications consult the TIM Specification document.

<sup>1</sup> Typical performance with an RI8587 Receiver.



© 2017 Roos Instruments Inc.

All rights reserved. Designed and published by Roos Instruments in Santa Clara, CA. PDF editions of this book are available upon request. Contact [support@roos.com](mailto:support@roos.com) for more information.

All product, product specifications, and data are subject to change without notice to improve performance, function, design, or otherwise.

The information in this document is to the best of our knowledge, accurate at the time of publication.

To the fullest extent of the law, neither the publisher nor the authors, contributors, or editors assume any liability for any injury and/or damage to persons or property as a matter of products liability, negligence or otherwise, or from any use or operation of any methods, products, instructions, or ideas contained in the material herein.

It is strictly prohibited to copy, redistribute, republish, or modify any materials contained herein or in subsequent support of this content without the prior written consent of Roos Instruments Inc.

Product names, logos, brands and other trademarks referred to within this book are the property of their respective trademark holders.

These trademark holders are not affiliated with Roos Instruments, Inc., our products, or our website. They do not sponsor or endorse our materials.

Below is a listing of these trademarks and their owners. This list is subject to change without notice.

iPad® - iPad is a trademark of Apple Inc., registered in the U.S. and other countries.

# ANSI (IMPERIAL)

The American National Standards Institute (ANSI, /'ænsiː/ an-see) is a private non-profit organization that oversees the development of voluntary consensus standards for products, services, processes, systems, and personnel in the United States. The organization also coordinates U.S. standards with international standards so that American products can be used worldwide. For example, standards ensure that people who own cameras can find the film they need for that camera anywhere around the globe.

ANSI accredits standards that are developed by representatives of other standards organizations, government agencies, consumer groups, companies, and others. These standards ensure that the characteristics and performance of products are consistent, that people use the same definitions and terms, and that products are tested the same way. ANSI also accredits organizations that carry out product or personnel certification in accordance with requirements defined in international standards.

---

## Related Glossary Terms

ISO (Metric)

---

**Index**

Find Term

**Chapter 7 - Module Repair Tools**

# CALIBRATION PLATE

Fixture bottom plate with a TIM interface insert layout designed to match a specific Cassini test head configuration for calibrating individual TIMs, custom or application-specific resource configurations, and the overall test system.

---

## Related Glossary Terms

Diagnostic Plate, Fixture

---

**Index**

Find Term

# DIAGNOSTIC PLATE

Fixture bottom plate with a TIM interface insert layout designed to match a specific Cassini test head configuration for conducting diagnostics on individual TIMs, custom or application-specific resource configurations, and/or the overall test system.

---

## Related Glossary Terms

Calibration Plate

---

**Index**

Find Term

# FIXTURE

Cassini fixtures carry the modular architecture of Cassini into the device interface environment. Housed in a rugged aluminum enclosure is a completely configurable test resource environment. The form factor and discrete design layers support an application range from DC to 90 GHz. Integration with Cassini's software allow fixtures to extend and enhance the capabilities of test instruments with an integrated calibration layer that carries signal accuracy right to the device pin. All the functionality and capability of traditional load boards have been reengineered to take advantage of the configurable instrument framework of Cassini. The discrete device interface layers enable design and development flexibility for high-performance RF devices that can be optimized independently to suite application needs.

---

## Related Glossary Terms

Calibration Plate, TIM

---

**Index**

Find Term

# INFRASTRUCTURE

The Cassini test system infrastructure is designed to deliver a low-cost, high-throughput ATE solution platforms to support mixed-signal, RF and microwave ICs. The three main elements to the Cassini architecture are:

An RF-based architecture designed for high accuracy, precisions, and test performance

A modular test head that supports a high-speed data bus and precision power bus

Small footprint, energy-efficient, system infrastructure and instruments

---

## Related Glossary Terms

TIM

---

**Index**

Find Term



# ISO (METRIC)

ISO, the International Organization for Standardization, is an independent, non-governmental organization, the members of which are the standards organization of the 163 member countries. It is the world's largest developer of voluntary international standards and facilitates world trade by providing common standards between nations. Nearly twenty thousand standards have been set covering everything from manufactured products and technology to food safety, agriculture and healthcare.

Use of the standards ensures that products and services are safe, reliable and of good quality. The standards help businesses increase productivity while minimizing errors and waste. By enabling products from different markets to be directly compared, they facilitate companies in entering new markets and assist in the development of global trade on a fair basis. The standards also serve to safeguard consumers and the end-users of products and services, ensuring that certified products conform to the minimum standards set internationally.

---

## Related Glossary Terms

ANSI (Imperial)

---

**Index**

Find Term

**Chapter 7 - Module Repair Tools**

# TIM

Stands for Test Instrument Module. Test instrument modules provide an application-specific instrument or instruments designed for the Cassini ATE system. They include a two latch, quick release latching system for docking and undocking to the test head. Each TIM provides resources through a blind-mate interface system designed to comply with Cassini fixtures and diagnostic/calibration interface plates. These self-contained, swappable instruments provide all the source, receive, measure, and signal processing capability for a broad range of DC, digital, mixed-signal, RF, and millimeter-wave applications.

---

## Related Glossary Terms

Fixture, Infrastructure

---

**Index**

Find Term